

YATO ®

2017



1	SPANNERS / KLUCZE	4-21
2	SOCKETS, ACCESSORIES & SETS / KLUCZE NASADOWE, AKCESORIA I ZESTAWY	22-77
3	IMPACT SOCKETS, ACCESSORIES & SETS / UDAROWE KLUCZE NASADOWE, AKCESORIA I ZESTAWY	78-87
4	TORQUE WRENCHES & TORQUE MULTIPLIERS / KLUCZE DYNAMOMETRYCZNE I WZMACNIACZE MOMENTU	88-91
5	SCREWDRIVERS & SCREWDRIIVER BITS / WKREŹTAKI I KOŃCÓWKI WKREŹTAKOWE	92-113
6	PLIERS & PIPE WRENCHES / SZCZYPCE I KLUCZE DO RUR	114-129
7	ELECTRICIAN TOOLS / NARZĘDZIA DLA ELEKTRYKÓW	130-151
8	HAMMERS, CHISELS, PUNCHES & AXES / MŁOTKI, DŁUTA, PRZECINAKI I SIEKIERY	152-161
9	CLAMPS, VICES & HOLDERS / ŚCISKI, IMADŁA I WSPORNIKI	162-167
10	CUTTING TOOLS / NARZĘDZIA TNĄCE	168-223
11	HYDRAULIC TOOLS / NARZĘDZIA HYDRAULICZNE	224-237
12	FASTENING TOOLS / NARZĘDZIA DO ŁĄCZENIA	238-249

13	CONSTRUCTION TOOLS / NARZĘDZIA BUDOWLANE	250-265
14	MEASURING TOOLS / NARZĘDZIA MIERNICZE	266-275
15	PNEUMATIC TOOLS / NARZĘDZIA PNEUMATYCZNE	276-291
16	SPECIAL AUTOMOTIVE TOOLS & EQUIPMENT / NARZĘDZIA I WYPOSAŻENIE WARSZTATU SAMOCHODOWEGO	292-393
17	WELDING EQUIPMENT & ACCESSORIES / NARZĘDZIA SPAWALNICZE I AKCESORIA	394-405
18	POWER & GASOLINE TOOLS / ELEKTRONARZĘDZIA I NARZĘDZIA SPALINOWE	406-439
19	PADLOCKS & LOCK CYLINDERS / KLÓDKI I WKŁADKI DO ZAMKÓW	440-443
20	ACCESSORIES / AKCESORIA	444-447
21	HEALTH & SAFETY ARTICLES / ARTYKUŁY BHP	448-461
22	ELECTRIC PRODUCTS / ARTYKUŁY ELEKTRYCZNE	462-475
23	GARDEN TOOLS / NARZĘDZIA OGRODNICZE	476-504

1

Spanners Klucze



Combination spanners Klucze płasko-oczkowe		6-8	Half-moon spanners Klucze oczkowe typu „C”		16
Combination spanners & sets, polished head Klucze płasko-oczkowe i zestawy, polerowana główka		6	Flare nut wrenches & sets Klucze oczkowe półotwarte i zestawy		16
Combination spanners & sets, satin finish Klucze płasko-oczkowe i zestawy, wykończenie satynowe		7			
Combination spanners S.A.E., polished head Klucze płasko-oczkowe S.A.E., polerowana główka		8	Flexible flare nut wrenches & sets Klucze oczkowe półotwarte z przegubem i zestawy		17
Stubby combination spanners, polished head Klucze płasko-oczkowe krótkie, polerowana główka		8			
Combination ratchet wrenches Klucze płasko-oczkowe z grzechotką		9-10	Torx ring spanner sets Zestawy kluczy oczkowych „Torx”		18
Combination ratchet wrenches & sets Klucze płasko-oczkowe z grzechotką i zestawy		9			
Rapid spline ratchet wrenches Klucze „szybkie” z grzechotką „Spline”		10	L-type socket wrenches Klucze nasadowe typu „L”		18
Flexible ratchet combination wrenches Klucze płasko-oczkowe z grzechotką i przegubem		10			
Double open end spanners Klucze płaskie		11	Double flexible socket wrenches Klucze nasadowe, przegubowe		18
Double open end spanners & sets, polished head Klucze płaskie i zestawy, polerowana główka		11			
Double open end spanners & sets, satin finish Klucze płaskie i zestawy, wykończenie satynowe		11	Tubular socket wrenches & accessories Klucze rurowe kute i akcesoria		19
Double ratchet spanner sets Zestawy kluczy oczkowych z grzechotką		12			
Bi-hexagonal ring spanners Klucze oczkowe odgięte		12-13	Double ratchet wrenches Dwustronne klucze nasadowe z grzechotką		19
Bi-hexagonal ring spanners & sets, polished head Klucze oczkowe odgięte i zestawy, polerowana główka		12			
Bi-hexagonal ring spanners & sets, satin finish Klucze oczkowe odgięte i zestawy, wykończenie satynowe		13	T-type socket wrenches Klucze nasadowe typu „T”		19-20
Insulated ring & open end wrenches Klucze oczkowe i płaskie izolowane		14	Socket wrenches with handle Klucze nasadowe z rękojeścią		19
Insulated ring wrenches Klucze oczkowe izolowane		14	T-type deep socket wrenches with rotary handle Klucze nasadowe typu „T” z obrotową rączką		20
Insulated open end wrenches Klucze płaskie izolowane		14	T-type adapters with rotary handle Adaptery typu „T” z obrotową rączką		20
Impact wrenches Klucze do pobijania		15	Insulated T-handle wrenches Rękojeści typu „T” z zabierakiem izolowane		20
Ring impact wrenches Klucze oczkowe do pobijania		15	T-type deep socket wrenches Klucze nasadowe typu „T”		20
Open end impact wrenches Klucze płaskie do pobijania		15	Adjustable wrenches Klucze nastawne		21

1

- GB Combination spanner
 D Maulringschlüssel
 PL Klucz płasko-oczkowy
 RUS Ключ комбинированный
 CZ Plochý a očkový klič
 H Kulcs villás-csillag
 RO Cheie combinată
- F Clé mixte à cliquet
 I Chiave combinata
 E Combinada con llave de estrella
 CN 两用扳手

DIN 3113 CrV AS-DRIVE



- application: workshop
- head offset: 15°
- surface finish: chromed, satin
- przeznaczenie: warsztat
- kąt odchylenia główki: 15°
- wykończenie powierzchni: chromowana, satynowa



YATO	Ø (mm)	L (mm)	B (mm)	D (mm)	S1 (mm)	S2 (mm)	PCS packing	
YT-0335	6	110	14.8	10.5	3.7	4.9	10	300/600
YT-0336	7	120	16.1	11.3	4.0	5.3	10	300/600
YT-0337	8	130	18.5	12.9	4.2	5.0	10	180/360
YT-0338	9	140	20.5	14.6	4.2	5.0	10	180/360
YT-0339	10	150	22.2	16.2	4.9	6.4	10	180/360
YT-0340	11	160	25.5	17.3	4.9	7.0	10	180/360
YT-0341	12	170	26.7	18.7	5.3	7.6	10	120/240
YT-0342	13	180	28.0	19.6	5.5	8.2	10	120/240
YT-0343	14	190	30.3	21.4	5.9	7.7	10	50/100
YT-0344	15	200	32.8	22.8	6.2	8.5	10	50/100
YT-0345	16	210	33.9	23.7	6.1	9.1	10	50/100
YT-0346	17	220	35.9	24.7	6.5	9.1	10	50/100
YT-0347	18	230	37.8	26.9	6.9	10.0	10	50/100

YATO	Ø (mm)	L (mm)	B (mm)	D (mm)	S1 (mm)	S2 (mm)	PCS packing	
YT-0348	19	235	38.9	27.7	7.0	10.1	10	50/100
YT-0349	20	250	41.4	29.2	7.3	11.0	10	40/80
YT-0350	21	260	43.4	31.0	7.1	10.9	10	40/80
YT-0351	22	270	45.9	32.2	8.1	11.2	5	20/40
YT-0352	23	280	47.8	34.3	7.8	11.1	5	20/40
YT-0353	24	290	49.9	34.8	9.2	11.2	5	20/40
YT-0354	25	300	51.2	36.6	9.2	12.4	5	20/40
YT-0355	26	310	53.2	37.4	9.2	12.9	5	20/40
YT-0356	27	320	55.9	39.3	9.3	12.7	5	15/30
YT-0357	28	330	56.5	40.9	9.9	13.5	5	15/30
YT-0358	29	340	60.0	42.4	10.0	13.6	5	15/30
YT-0359	30	350	60.9	43.8	10.0	14.7	5	10/20
YT-0360	32	370	64.5	46.6	11.3	14.9	5	10/20

- GB Combination spanner
 D Maulringschlüssel
 PL Klucz płasko-oczkowy
 RUS Ключ комбинированный
 CZ Plochý a očkový klič
 H Kulcs villás-csillag
 RO Cheie combinată
- F Clé mixte à cliquet
 I Chiave combinata
 E Combinada con llave de estrella
 CN 两用扳手

AS-DRIVE

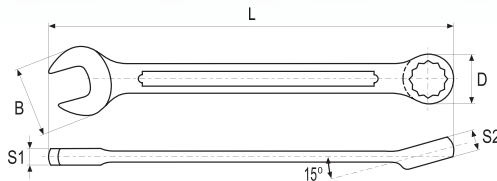

- application: workshop
- head offset: 15°
- surface finish: chromed, satin
- przeznaczenie: warsztat
- kąt odchylenia główki: 15°
- wykończenie powierzchni: chromowana, satynowa



YATO	Ø (mm)	L (mm)	B (mm)	D (mm)	S1 (mm)	S2 (mm)	PCS packing	
YT-00760	34	425	65.2	51.0	13.0	16.0	5	20
YT-00761	36	460	73.0	57.0	14.0	17.5	5	15
YT-00762	38	460	73.0	57.0	14.0	17.5	5	15
YT-00763	41	500	83.0	61.5	15.0	19.0	5	10
YT-00764	46	540	88.3	69.0	16.5	21.0	5	10

YATO	Ø (mm)	L (mm)	B (mm)	D (mm)	S1 (mm)	S2 (mm)	PCS packing	
YT-00765	48	570	92.0	72.0	16.5	22.0	5	10
YT-00766	50	598	96.0	74.0	18.0	23.5	2	8
YT-00767	55	620	105.6	82.4	19.0	25.0	2	6
YT-00768	60	660	115.2	89.8	21.0	27.0	2	6
YT-00769	65	680	124.8	97.3	23.0	29.0	2	4

- GB Combination spanner set
 D Maulringschlüsselsatz
 PL Komplet kluczy płasko-oczkowych
 RUS Набор ключей комбинированных
- CZ Souprava plochých a očkových kličů
 H Kulcskészlet, villás-csillag
 RO Set chei combinate
 F Set de clés mixtes
- I Set chiave combinata
 E Juego de combinadas con llave de estrella
 CN 两用扳手组套



DIN 3113 CrV AS-DRIVE



12 PCS 8, 9, 10, 11, 12, 13, 14, 15, 17, 19, 22, 24 mm

17 PCS 8, 9, 10, 11, 12, 13, 14, 15, 16, 17, 18, 19, 22, 24, 27, 30, 32 mm

25 PCS 6, 7, 8, 9, 10, 11, 12, 13, 14, 15, 16, 17, 18, 19, 20, 21, 22, 23, 24, 25, 26, 27, 28, 30, 32 mm

YATO	YT-0362	6
------	---------	---

YATO	YT-0363	3
------	---------	---

YATO	YT-0365	3
------	---------	---

- GB Combination spanner
D Maulringschlüssel
PL Klucz płasko-oczkowy
RUS Ключ комбинированный
CZ Plochy a očkový klíč
H Kulcs villás-csillag
RO Cheie combinată
- F Clé mixte à cliquet
I Chiave combinata
E Combinada con llave de estrella
CN 两用扳手

DIN 3113 CrV 6140 AS-DRIVE

1

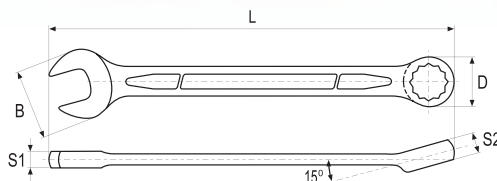

- application: industry
- head offset: 15°
- maximum torque exceeding DIN and ANSI standards by 60%
- surface finish: chromed, satin
- przeznaczenie: przemysł
- kąt odchylenia główki: 15°
- maksymalny moment obrotowy większy o 60% niż w standardach DIN i ANSI
- wykończenie powierzchni: chromowana, satynowa

COLOR BOX



YATO	Ø (mm)	L (mm)	B (mm)	D (mm)	S1 (mm)	S2 (mm)	PCS packing:	
YT-0006	6	109	14.4	10.3	3.7	5.2	10	600
YT-0007	7	119	16.2	11.3	3.8	5.2	10	600
YT-0008	8	129	18.6	12.8	4.2	5.7	10	360
YT-0009	9	139	20.7	14.1	4.3	6.4	10	360
YT-0010	10	149	22.6	15.2	4.8	6.9	10	360
YT-0011	11	159	24.6	16.8	5.2	7.4	10	360
YT-0012	12	169	27.1	18.0	5.3	7.9	10	240
YT-0013	13	179	28.7	19.8	6.0	8.6	10	240
YT-0014	14	189	31.3	20.8	6.2	8.9	10	100
YT-0015	15	199	33.2	22.3	6.6	9.2	10	100
YT-0016	16	209	35.0	23.8	6.8	9.9	10	100
YT-0017	17	219	37.5	25.0	7.0	10.9	10	100
YT-0018	18	229	39.5	26.6	7.8	11.4	10	100
YT-0019	19	239	41.3	28.0	8.0	12.1	10	100
YT-0020	20	249	44.1	29.8	8.3	12.4	10	80
YT-0021	21	259	46.1	30.8	8.6	12.7	10	80

YATO	Ø (mm)	L (mm)	B (mm)	D (mm)	S1 (mm)	S2 (mm)	PCS packing:	
YT-0022	22	269	48.2	32.2	9.0	13.1	5	40
YT-0023	23	279	49.8	33.6	9.2	13.4	5	40
YT-0024	24	289	51.4	34.3	9.6	13.4	5	40
YT-0025	25	299	54.6	36.8	9.8	14.2	5	40
YT-0026	26	309	56.2	37.3	10.0	14.9	5	40
YT-0027	27	319	58.7	39.6	10.4	16.4	5	30
YT-0028	28	329	59.4	40.7	10.8	16.9	5	30
YT-0030	30	349	63.0	43.3	11.3	18.4	5	30
YT-0032	32	369	67.3	44.8	11.8	19.4	4	24
YT-0036	36	435	74.0	53.5	13.8	19.5	-	5/10
YT-0038	38	445	76.0	55.0	16.3	20.3	-	5/10
YT-0041	41	475	83.7	61.6	16.3	20.3	-	2/8
YT-0046	46	545	99.0	75.3	19.5	22.7	-	2/8
YT-0050	50	545	99.5	76.0	19.5	22.7	-	2/8
YT-0055	55	610	110.0	80.0	19.5	22.7	-	2/4

- GB Combination spanner set
D Maulringschlüsselsatz
PL Komplet kluczy płasko-oczkowych
RUS Набор ключей комбинированных
- CZ Souprava plochých a očkových klíčů
H Kulcskészlet, villás-csillag
RO Set chei combinate
F Set de clés mixtes
- I Set chiave combinata
E Juego de combinadas con llave de estrella
CN 两用扳手组套

POUCH & COLOR BOX



DIN 3113 CrV 6140

AS-DRIVE



10 PCS
6, 7, 8, 10, 12, 13, 14, 15, 17, 19 mm

YATO
YT-0060 20

12 PCS
8, 9, 10, 11, 12, 13, 14, 15, 17, 19, 22, 24 mm

YATO
YT-0062 6



15 PCS
6, 7, 8, 10, 11, 12, 13, 14, 15, 17, 18, 19, 22, 24, 27 mm

YATO
YT-0065 8

17 PCS
8, 9, 10, 11, 12, 13, 14, 15, 16, 17, 18, 19, 22, 24, 27, 30, 32 mm

YATO
YT-0067 3



25 PCS
6, 7, 8, 9, 10, 11, 12, 13, 14, 15, 16, 17, 18, 19, 20, 21, 22, 23, 24, 25, 26, 27, 28, 30, 32 mm

YATO
YT-0075 3

1

- GB Combination spanner
- D Maulringschlüssel
- PL Klucz płasko-oczkowy
- RUS Ключ комбинированный
- CZ Plochý a očkový klíč
- H Kulcs villás-csillag
- RO Cheie combinată
- F Clé mixte à cliquet
- I Chiave combinata
- E Combinada con llave de estrella
- CN 两用扳手

S.A.E. DIN 3113 CrV AS-DRIVE

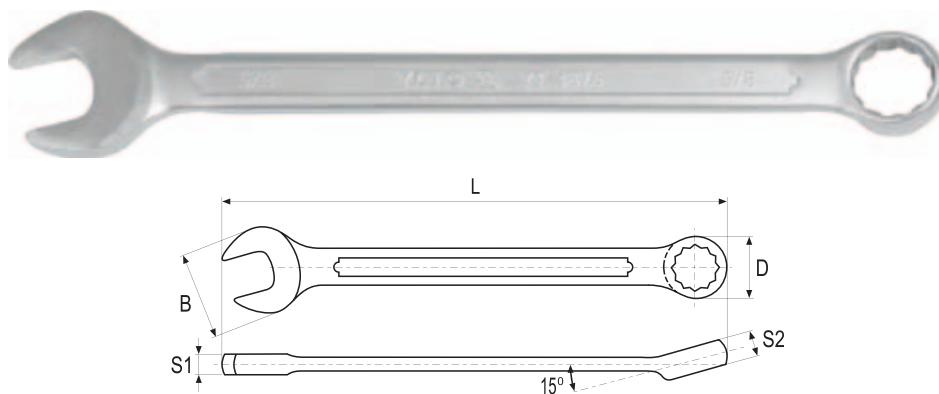

- application: workshop
- head offset: 15°
- surface finish: chromed, satin / mirror
- przeznaczenie: warsztat
- kąt odchylenia główek: 15°
- wykończenie powierzchni: chromowana, satynowa / polerowana



YATO	Ø	L (mm)	B (mm)	D (mm)	S1 (mm)	S2 (mm)	PCS packing	
YT-4870	1/4" (6.3 mm)	110	13.9	10.7	4.0	4.9	10	300/600
YT-4871	5/16" (7.9 mm)	130	17.6	12.8	4.6	5.7	10	180/360
YT-4872	3/8" (9.5 mm)	150	21.5	15.5	4.8	6.1	10	180/360
YT-4873	7/16" (11.1 mm)	160	23.8	17.0	5.1	6.7	10	180/360
YT-4874	1/2" (12.7 mm)	180	27.6	19.9	5.6	8.0	10	120/240
YT-4875	9/16" (14.3 mm)	190	29.6	21.6	6.1	8.1	10	120/240
YT-4876	5/8" (15.9 mm)	210	33.6	23.9	6.3	9.2	10	50/100
YT-4877	11/16" (17.5 mm)	230	37.8	26.3	6.7	10.8	10	50/100
YT-4878	3/4" (19.0 mm)	240	40.1	27.9	7.2	10.6	10	50/100
YT-4879	13/16" (20.6 mm)	260	43.2	31.1	7.6	10.8	10	40/80
YT-4880	7/8" (22.2 mm)	270	46.5	32.9	8.4	11.6	5	20/40
YT-4881	15/16" (23.8 mm)	290	50.2	34.9	8.7	12.0	5	20/40
YT-4882	1" (25.4 mm)	300	51.9	36.2	8.8	12.7	5	20/40
YT-4883	1-1/16" (27.0 mm)	320	56.0	38.9	9.3	13.6	5	15/30
YT-4884	1-1/8" (28.6 mm)	340	59.7	42.2	9.8	14.2	5	15/30
YT-4885	1-1/4" (31.8 mm)	370	65.5	46.2	10.9	15.6	5	10/20

- GB Stubby combination spanner
- D Maulringschlüssel
- PL Klucz płasko-oczkowy krótki
- RUS Ключ комбинированный
- CZ Plochý a očkový klíč
- H Kulcs villás-csillag
- RO Cheie combinată
- F Clé mixte courte
- I Chiave combinata corta
- E Combinada con llave de estrella
- CN 两用扳手

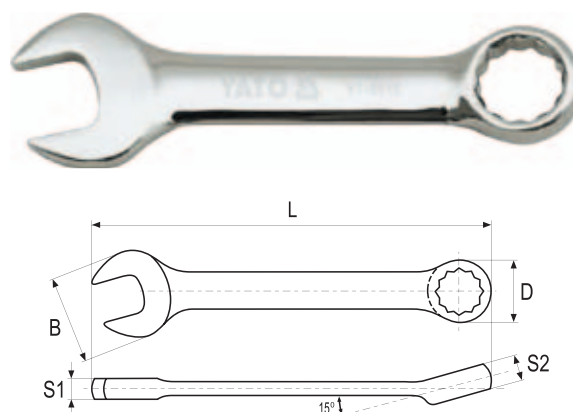

- application: workshop
- head offset: 15°
- surface finish: chromed
- przeznaczenie: warsztat
- kąt odchylenia główek: 15°
- wykończenie powierzchni: chromowana



YATO	Ø (mm)	L (mm)	B (mm)	D (mm)	S1 (mm)	S2 (mm)	PCS packing	
YT-4901	8	91	19.2	13.9	5.0	6.3	10	120/240
YT-4902	9	97	21.7	16.4	5.4	6.4	10	120/240
YT-4903	10	97	21.9	16.6	5.2	6.4	10	120/240
YT-4904	11	100	23.2	18.3	5.9	7.2	10	120/240
YT-4905	12	108	27.4	20.2	6.4	7.6	10	120/240
YT-4906	13	109	27.9	20.7	6.7	7.7	10	120/240
YT-4907	14	115	29.3	22.1	6.1	8.3	10	60/120
YT-4908	15	120	31.2	24.0	6.8	9.6	10	60/120
YT-4909	16	121	32.0	24.3	6.8	9.6	10	60/120
YT-4910	17	128	36.6	27.1	7.4	9.9	10	60/120
YT-4911	18	127	36.2	26.8	7.4	9.9	10	60/120
YT-4912	19	135	39.2	29.5	8.8	10.8	10	60/120

GB Combination ratchet wrench
D Ratschenringmaulschlüssel
PL Klucz płasko-oczkowy z grzechotką
RUS Ключ комбинированный с трещоткой
CZ Klíč očkoplochy ráčnový
H Csillag-villás kulcs racsnis
RO Cheie combinata cu crichet

F Clé mixte à cliquet
I Chiave combinata a cricchetto reversibile
E Llave combinada fija abierta y carraca
CN 棘轮两用扳手



72T

CrV
6140

AS-DRIVE

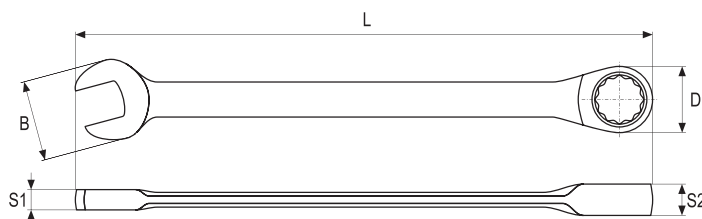

- application: service
- 72 teeth ratchet
- minimum operation angle: 5°
- surface finish: chromed, mirror

- przeznaczenie: serwis
- grzechotka 72 zęby
- minimalny kąt pracy: 5°
- wykończenie powierzchni: chromowana, polerowana



YATO	Ø (mm)	L (mm)	B (mm)	D (mm)	S1 (mm)	S2 (mm)	PCS packing	
YT-01906	6	120	14.7	18.0	4.0	6.5	10	50/100
YT-01907	7	130	16.2	18.0	4.3	7.0	10	50/100
YT-01908	8	141	17.6	18.2	4.8	7.2	10	50/100
YT-01909	9	151	19.4	20.4	4.8	7.4	10	50/100
YT-0191	10	160	22.1	22.2	6.0	7.8	10	50/100
YT-0192	11	165	24.7	24.2	6.6	8.5	10	50/100
YT-0193	12	170	26.4	25.5	6.7	8.9	10	50/100
YT-0194	13	180	27.5	26.7	6.6	9.2	10	50/100
YT-0195	14	190	30.8	29.0	7.4	9.4	10	50/100
YT-0196	15	200	32.9	30.8	7.7	10.1	10	50/100
YT-0197	16	210	34.3	31.5	7.8	10.3	10	50/100
YT-0198	17	225	36.8	33.6	8.4	10.6	10	50/100
YT-0199	18	235	39.2	35.6	9.1	10.8	10	50/100
YT-0200	19	245	40.1	37.3	9.5	11.3	10	50/100
YT-0189	21	290	45.2	43.0	9.9	13.3	6	30/60
YT-0201	22	290	45.6	44.2	10.5	13.4	6	24/48
YT-0202	24	335	52.8	50.0	11.3	14.5	6	48
YT-0203	25	335	52.0	47.4	10.2	14.3	6	30
YT-0204	27	355	55.6	52.7	10.9	15.7	6	30
YT-0205	30	400	62.5	57.7	12.2	17.1	6	24
YT-0206	32	420	65.0	61.7	13.2	17.9	6	24

GB Combination ratchet wrench set
D Knarrenringmaulschlüssel-satz
PL Komplet kluczy płasko-oczkowych z grzechotką
RUS Набор комбинированных ключей с трещоткой
CZ Klíče ráčnové sada
H Racsnis csillag-villás kulcs készlet
RO Set chei combinate
F Set de clés mixte à cliquet
I Set chiavi combinate a cricchetto
E Juego de llaves planas con matraca
CN 棘轮扳手组套

7
PCSCrV
6140

72T



AS-DRIVE

PLASTIC
HANGER

10, 12, 13, 14, 15, 17, 19 mm

YATO
YT-0208

10/20

1

- GB Combination ratchet wrench
- D Ratschenringmaulschlüssel
- PL Klucz płasko-oczkowy z grzechotką
- RUS Ключ комбинированный с трещоткой
- CZ Kľúč očkoplochý ráčnový
- H Csillag-villás kulcs racsnis
- RO Cheie combinată cu crichet
- F Clé mixte à cliquet
- I Chiave combinata a cricchetto reversibile
- E Llave combinada fija abierta y carraca
- CN 棘轮两用扳手

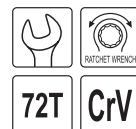
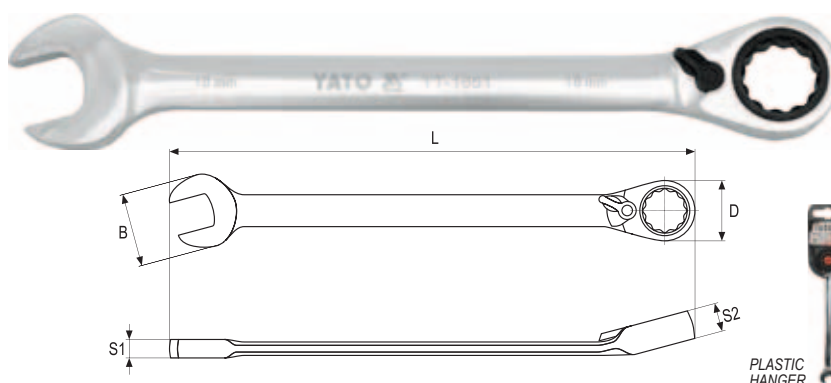

YATO	Ø (mm)	L (mm)	B (mm)	D (mm)	S1 (mm)	S2 (mm)	PCS packing	Box
YT-1651	8	140	17.5	19.0	6.0	7.2	10	50/100
YT-1652	9	150	19.8	20.7	6.4	7.5	10	50/100
YT-1653	10	160	22.1	23.1	6.4	7.9	10	50/100
YT-1654	11	165	23.9	25.0	6.6	8.4	10	50/100
YT-1655	12	170	27.1	26.0	6.5	8.9	10	50/100
YT-1656	13	180	27.9	27.6	7.1	9.1	10	50/100
YT-1657	14	190	31.6	28.3	7.3	9.5	10	50/100
YT-1658	15	200	32.8	31.4	8.1	9.8	10	50/100
YT-1659	16	210	33.9	32.9	8.4	10.3	10	50/100
YT-1660	17	225	38.0	34.5	8.7	10.5	10	50/100
YT-1661	18	235	39.8	36.9	9.3	10.7	10	50/100

YATO	Ø (mm)	L (mm)	B (mm)	D (mm)	S1 (mm)	S2 (mm)	PCS packing	Box
YT-1662	19	245	41.8	38.3	9.5	11.3	10	50/100
YT-1663	20	245	41.9	38.1	9.7	11.4	6	30/60
YT-1664	21	290	44.9	43.0	9.8	13.6	6	30/60
YT-1665	22	290	44.8	43.8	10.0	13.6	6	30/60
YT-1666	23	290	44.9	43.3	10.3	13.7	6	24/48
YT-1667	24	330	52.0	49.4	10.2	14.5	6	24/48
YT-1669	26	360	56.3	53.6	12.1	15.7	6	30
YT-1670	27	360	55.6	52.9	12.2	16.1	6	30
YT-1671	28	360	56.1	53.6	12.6	16.0	6	24
YT-1672	30	400	62.1	58.0	11.9	17.2	6	24
YT-1673	32	420	64.1	62.0	12.9	17.7	6	24

- GB Rapid combination ratchet wrench
- D Ratschenringmaulschlüssel
- PL Klucz „szybki” z grzechotką
- RUS Ключ комбинированный с трещоткой
- CZ Kľúč očkoplochý ráčnový
- H Csillag-villás kulcs racsnis
- RO Cheie combinată cu crichet
- F Clé mixte à cliquet
- I Chiave combinata a cricchetto veloce
- E Llave combinada fija abierta y carraca
- CN 棘轮两用扳手

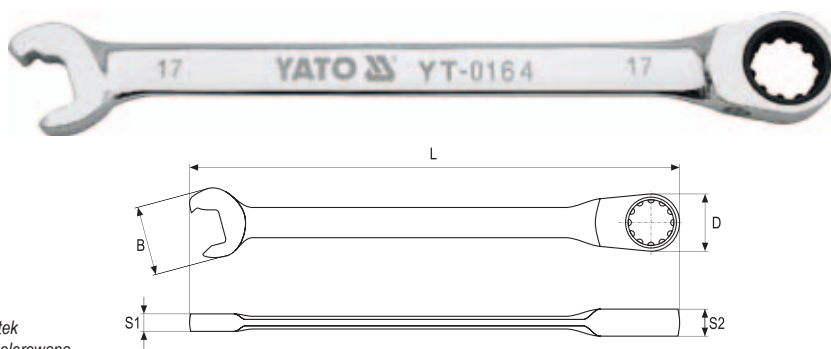
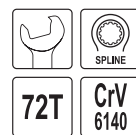
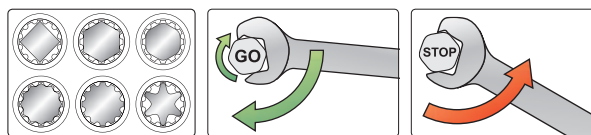

- application: industry
- 72 teeth ratchet
- minimum operation angle: 5°
- spline profile serves for 5 types of nuts
- surface finish: chromed, mirror
- przeznaczenie: przemysł
- grzechotka 72 zęby
- minimalny kąt pracy: 5°
- profil Spline – obsługuje 5 rodzajów nakrętek
- wykończenie powierzchni: chromowana, polerowana

YATO	Ø (mm)	L (mm)	B (mm)	D (mm)	S1 (mm)	S2 (mm)	Box
YT-0156	9	150	16.65	19.40	4.65	7.28	10/100
YT-0158	11	165	20.32	21.55	5.70	8.20	10/100

YATO	Ø (mm)	L (mm)	B (mm)	D (mm)	S1 (mm)	S2 (mm)	Box
YT-0162	15	202	27.80	27.55	7.30	8.20	10/100
YT-0163	16	215	30.20	28.55	7.55	9.92	10/100

- GB Flexible ratchet combination wrench
- D Ratschenringmaulschlüssel
- PL Klucz płasko-oczkowy z grzechotką i przegubem
- RUS Ключ комбинированный с трещоткой
- CZ Kľúč očkoplochý ráčnový
- H Csillag-villás kulcs racsnis
- RO Cheie combinată cu crichet
- F Clé mixte à cliquet tête articulée
- I Chiave combinata a cricchetto testa mobile
- E Llave combinada fija abierta y carraca
- CN 活头棘轮两用扳手

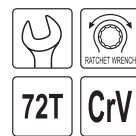
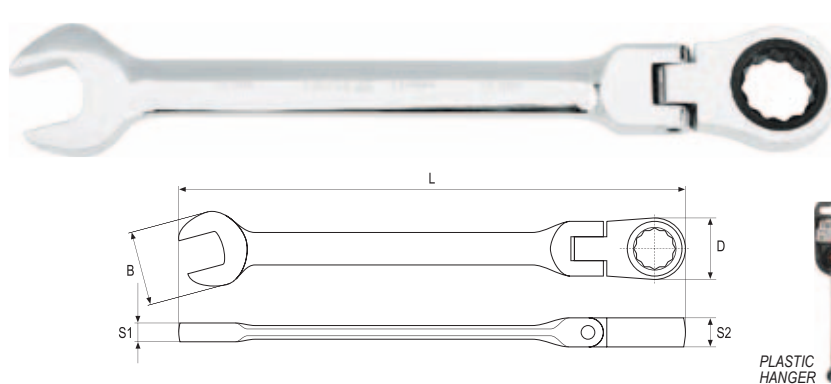

YATO	Ø (mm)	L (mm)	B (mm)	D (mm)	S1 (mm)	S2 (mm)	PCS packing	Box
YT-1674	8	140	18.0	19.6	6.3	7.3	10	50/100
YT-1675	9	145	19.7	21.1	4.7	7.6	10	50/100
YT-1676	10	160	22.8	23.2	6.3	7.8	10	50/100
YT-1677	11	160	24.0	24.7	5.4	8.5	10	50/100
YT-1678	12	170	26.4	26.7	6.8	8.8	10	50/100
YT-1679	13	180	28.4	27.3	7.2	9.1	10	50/100
YT-1680	14	185	29.5	28.7	6.8	9.4	10	50/100
YT-1681	15	195	32.9	30.8	7.2	9.8	10	50/100
YT-1682	16	210	34.4	33.3	7.6	10.3	10	50/100
YT-1683	17	230	36.7	35.7	8.3	10.5	10	50/100

YATO	Ø (mm)	L (mm)	B (mm)	D (mm)	S1 (mm)	S2 (mm)	PCS packing	Box
YT-1684	18	235	39.0	35.9	8.0	10.8	10	50/100
YT-1685	19	245	40.8	37.6	9.5	11.2	10	50/100
YT-1686	20	245	40.9	38.2	8.8	11.1	6	30/60
YT-1687	21	290	45.0	42.8	9.8	13.6	6	30/60
YT-1688	22	290	45.2	42.7	9.8	13.5	6	30/60
YT-1689	23	290	45.3	42.8	9.6	13.6	6	24/48
YT-1690	24	330	51.3	48.7	10.4	14.5	6	24/48
YT-1691	25	330	51.4	48.4	10.6	14.5	6	24/48
YT-1692	26	360	56.6	53.6	11.6	15.7	6	30
YT-1694	28	360	56.4	53.5	11.0	15.8	6	24

- GB Double open end spanner
- D Doppelmaulschlüssel
- PL Klucz płaski
- RUS Ключ рожковый
- CZ Plochý klíč
- H Villáskulcs
- RO Cheie fixă
- F Clé plate
- I Chiave piatta
- E Llave fija
- CN 双头呆扳手

- surface finish:
chromed, satin / mirror
- wykończenie powierzchni:
chromowana, satynowa / polerowana

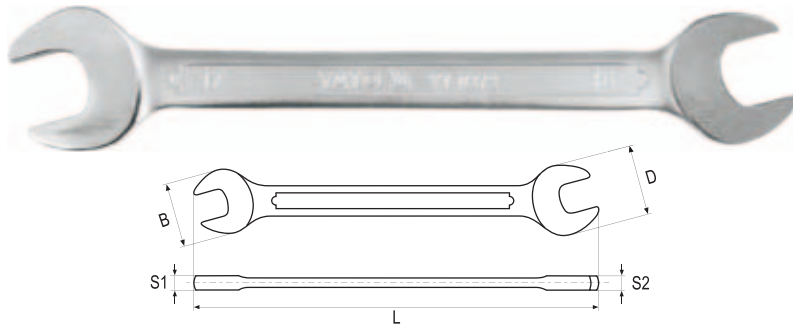

DIN 3110 CrV



YATO	Ø (mm)	L (mm)	B (mm)	D (mm)	S1 (mm)	S2 (mm)	PCS packing:
YT-0367	6x7	120	15.1	16.8	3.5	3.6	10 360/720
YT-0368	8x9	140	18.7	20.8	3.7	3.6	10 180/360
YT-0369	10x11	155	22.4	25.5	4.6	4.6	10 150/300
YT-0332	10x13	170	22.5	29.3	4.6	5.3	10 150/300
YT-0370	12x13	170	27.1	29.3	4.9	5.3	10 80/160
YT-0333	13x17	180	29.3	37.5	5.3	6.3	10 50/100
YT-0371	14x15	180	31.0	33.0	5.3	5.4	10 80/160
YT-0372	16x17	200	34.9	37.5	6.5	6.3	10 50/100

YATO	Ø (mm)	L (mm)	B (mm)	D (mm)	S1 (mm)	S2 (mm)	PCS packing:
YT-0334	17x19	220	37.5	38.7	6.3	6.3	10 50/100
YT-0373	18x19	220	38.7	41.0	6.6	6.3	10 50/100
YT-0374	20x22	230	42.1	46.8	7.1	6.8	10 30/60
YT-0375	21x23	245	44.4	48.6	7.3	6.9	10 30/60
YT-0376	24x27	260	51.6	56.9	8.1	8.1	5 20/40
YT-0377	25x28	270	52.3	57.9	8.4	8.3	5 20/40
YT-0378	30x32	295	61.4	65.1	8.0	8.6	5 15/30

- GB Double open end spanner set
- D Doppelmaulschlüsselsatz
- PL Komplet kluczy płaskich
- RUS Набор рожковых ключей
- CZ Souprava plochých klíčů
- H Kulcskészlet, villás
- RO Set chei fixe
- F Set de clés à tête fendue
- I Set di chiavi piatte
- E Juego de llaves fijas
- CN 双头呆扳手组套

POUCH & COLOR BOX



DIN 3110

CrV

10 PCS 6x7, 8x9, 10x11, 12x13, 14x15, 16x17, 18x19, 20x22, 21x23, 24x27 mm

YATO YT-0380 6

12 PCS 6x7, 8x9, 10x11, 12x13, 14x15, 16x17, 18x19, 20x22, 21x23, 24x27, 25x28, 30x32 mm

YATO YT-0381 8

- GB Double open end spanner
- D Doppelmaulschlüssel
- PL Klucz płaski
- RUS Ключ рожковый
- CZ Plochý klíč
- H Villáskulcs
- RO Cheie fixă
- F Clé plate
- I Chiave piatta
- E Llave fija
- CN 双头呆扳手

- surface finish:
chromed, satin
- wykończenie powierzchni:
chromowana, satynowa

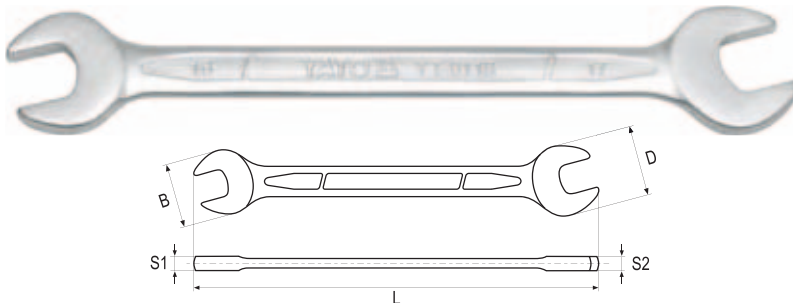

DIN 3110 CrV 6140



YATO	Ø (mm)	L (mm)	B (mm)	D (mm)	S1 (mm)	S2 (mm)	PCS packing:
YT-0107	6x7	128	15.5	17.5	3.8	3.8	10 600
YT-0109	8x9	146	19.4	21.4	4.3	4.3	10 360
YT-0110	8x10	146	19.4	21.4	4.3	4.3	10 360
YT-0111	10x11	162	23.5	25.7	5.0	5.0	10 360
YT-0112	10x13	175	27.7	30.2	5.3	5.3	10 120
YT-0113	12x13	175	27.7	30.2	5.3	5.3	10 120
YT-0115	14x15	191	31.7	33.7	5.8	5.8	10 120
YT-0117	13x17	195	31.7	38.7	6.2	6.2	10 120
YT-0118	16x17	212	36.2	38.2	6.3	6.3	10 100

YATO	Ø (mm)	L (mm)	B (mm)	D (mm)	S1 (mm)	S2 (mm)	PCS packing:
YT-0119	17x19	224	40.2	42.2	6.8	6.8	10 100
YT-0120	18x19	224	40.2	42.2	6.8	6.8	10 100
YT-0122	19x22	237	44.2	48.2	7.5	7.5	10 60
YT-0123	20x22	237	44.2	48.2	7.5	7.5	10 60
YT-0125	21x23	247	46.2	50.2	7.8	7.8	10 60
YT-0127	24x27	268	53.2	57.7	8.4	8.4	5 40
YT-0128	25x28	268	53.2	57.7	8.4	8.4	5 40
YT-0132	30x32	295	64.2	68.2	9.4	9.4	5 40

- GB Double open end spanner set
- D Doppelmaulschlüsselsatz
- PL Komplet kluczy płaskich
- RUS Набор рожковых ключей
- CZ Souprava plochých klíčů
- H Kulcskészlet, villás
- RO Set chei fixe
- F Set de clés à tête fendue
- I Set di chiavi piatte
- E Juego de llaves fijas
- CN 双头呆扳手组套

POUCH & COLOR BOX



DIN 3110

CrV 6140

10 PCS 6x7, 8x9, 10x11, 12x13, 14x15, 16x17, 18x19, 20x22, 21x23, 24x27 mm

YATO YT-0150 6

12 PCS 6x7, 8x9, 10x11, 12x13, 14x15, 16x17, 18x19, 20x22, 21x23, 24x27, 25x28, 30x32 mm

YATO YT-0152 8

1

- GB Double ratchet spanner set
- D Ringschlüsselsatz
- PL Klucze oczkowe z grzechotką
- RUS Набор ключей накидных
- CZ Očkové klíče
- H Csillagkulcs készlet
- RO Set chei inelare
- F Set de clés à œil à cliquet
- I Set chiavi a cricchetto
- E Llaves de anillo
- CN 双头梅花棘轮扳手组套



5 PCS RATCHET WRENCH CrV 6140 72T



8x9, 10x11, 12x13, 14x15, 17x19 mm

YATO	
YT-5038	10/30

- GB Bi-hexagonal ring spanner
- D Doppelringschlüssel
- PL Klucze oczkowe odgięte
- RUS Ключ накидной изогнутый
- CZ Očkový klíč ohnutý
- H Hajlítotszárú csillagkulcs
- RO Cheie inelaro-curbată
- F Clé contre-coudée
- I Chiave poligonale doppio piegato
- E Llave de estrella
- CN 双头高颈梅花扳手

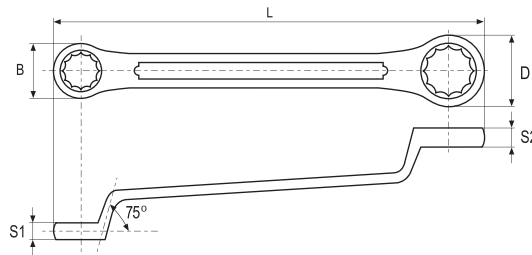

- application: industry
- surface finish: chromed, satin / mirror
- przeznaczenie: przemysł
- wykończenie powierzchni: chromowana, satynowa / polerowana

DIN 838 CrV AS-DRIVE



COLOR BOX

YATO	Ø (mm)	L (mm)	B (mm)	D (mm)	S1 (mm)	S2 (mm)	PCS packing	
YT-0383	6x7	165	11.0	12.7	5.4	5.5	10	200/400
YT-0384	8x9	185	13.9	15.5	6.8	7.2	10	100/200
YT-0385	10x11	200	16.3	17.6	6.8	7.2	10	100/200
YT-0386	12x13	220	19.6	21.5	7.2	7.7	10	60/120
YT-0387	14x15	230	23.6	21.9	8.9	9.1	10	50/100
YT-0388	16x17	255	24.6	26.4	8.6	9.3	10	30/60

YATO	Ø (mm)	L (mm)	B (mm)	D (mm)	S1 (mm)	S2 (mm)	PCS packing	
YT-0389	18x19	270	27.5	28.8	10.5	10.2	5	25/50
YT-0390	20x22	290	30.9	33.4	10.5	11.4	5	20/40
YT-0391	21x23	310	31.9	34.4	11.8	12.4	5	20/40
YT-0392	24x27	330	36.2	40.6	11.5	13.2	5	20/40
YT-0394	30x32	390	44.0	47.1	13.8	14.9	3	15/30

- GB Bi-hexagonal ring spanner set
- D Doppelringschlüsselsatz
- PL Komplet kluczy oczkowych odgiętych
- RUS Набор ключей накидных изогнутых
- CZ Klíče očkové vyhnuté sada
- H Csillagkulcs készlet
- RO Set chei inelare cu cot
- F Set de clés contre-coudées

- I Set chiavi poligonali doppie piegate
- E Juego de llaves de estrella acodadas
- CN 双头高颈梅花扳手组套



POUCH & COLOR BOX

DIN 838

CrV

AS-DRIVE



8 PCS 6x7, 8x9, 10x11, 12x13, 14x15, 16x17, 18x19, 20x22 mm

YATO YT-0396 6

12 PCS 6x7, 8x9, 10x11, 12x13, 14x15, 16x17, 18x19, 20x22, 21x23, 24x27, 25x28, 30x32 mm

YATO YT-0398 4

- GB Bi-hexagonal ring spanner
- D Doppelringschlüssel
- PL Klucz oczkowy odgięty
- RUS Ключ накладной изогнутый
- CZ Očkový klíč ohnutý
- H Hajlítotszárú csillagkulcs
- RO Cheie inelaro-curbată
- F Clé contre-coudée
- I Chiave poligonale doppio piegato
- E Llave de estrella
- CN 双头高颈梅花扳手

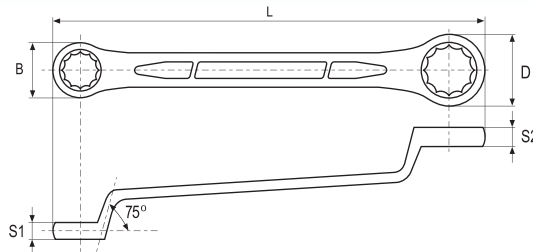

- application: industry
- surface finish: chromed, satin
- przeznaczenie: przemysł
- wykończenie powierzchni: chromowana, satynowa

COLOR BOX



YATO	Ø (mm)	L (mm)	B (mm)	D (mm)	S1 (mm)	S2 (mm)	PCS packing:	
YT-02330	32x36	408	52	46	17.5	17.5	5	20
YT-02331	36x41	448	58	52	18.0	18.0	5	20
YT-02332	41x46	483	65	58	18.5	18.5	5	15

YATO	Ø (mm)	L (mm)	B (mm)	D (mm)	S1 (mm)	S2 (mm)	PCS packing:	
YT-02333	46x50	495	71	65	19.0	19.0	5	10
YT-02334	50x55	538	78	71	19.5	19.5	5	10

- GB Bi-hexagonal ring spanner
- D Doppelringschlüssel
- PL Klucz oczkowy odgięty
- RUS Ключ накладной изогнутый
- CZ Očkový klíč ohnutý
- H Hajlítotszárú csillagkulcs
- RO Cheie inelaro-curbată
- F Clé contre-coudée
- I Chiave poligonale doppio piegato
- E Llave de estrella
- CN 双头高颈梅花扳手

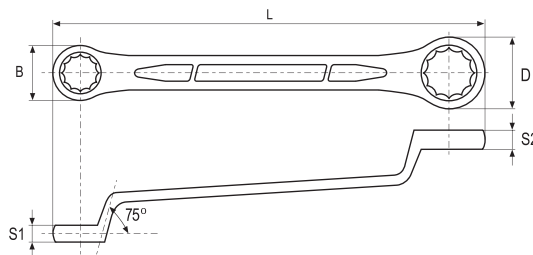

- application: industry
- maximum torque exceeding DIN and ANSI standards by 60%
- surface finish: chromed, satin
- przeznaczenie: przemysł
- maksymalny moment obrotowy większy o 60% niż w standardach DIN i ANSI
- wykończenie powierzchni: chromowana, satynowa

DIN 838

CrV 6140

AS-DRIVE

COLOR BOX



YATO	Ø (mm)	L (mm)	B (mm)	D (mm)	S1 (mm)	S2 (mm)	PCS packing:	
YT-0207	6x7	168	10.4	11.9	5.7	6.2	10	320
YT-0209	8x9	183	13.3	14.8	6.7	7.2	10	160
YT-0211	10x11	198	16.3	17.7	7.7	8.8	10	100
YT-0213	12x13	217	19.2	20.6	8.7	9.2	10	100
YT-0215	14x15	239	22.1	23.4	9.6	10.1	5	50
YT-0217	16x17	260	25.0	26.4	10.6	10.9	5	60

YATO	Ø (mm)	L (mm)	B (mm)	D (mm)	S1 (mm)	S2 (mm)	PCS packing:	
YT-0219	18x19	292	27.9	29.4	11.2	11.5	5	60
YT-0222	20x22	318	30.8	33.7	11.8	12.5	5	30
YT-0223	21x23	326	32.3	35.2	12.1	12.8	5	30
YT-0227	24x27	329	36.6	40.7	13.1	14.0	5	30
YT-0228	25x28	347	38.1	42.5	14.0	14.3	2	16
YT-0232	30x32	362	45.2	49.2	15.0	15.7	2	16

- GB Bi-hexagonal ring spanner set
- D Doppelringschlüsselsatz
- PL Komplet kluczy oczkowych odgiętych
- RUS Набор ключей накладных изогнутых
- CZ Klíče očkové vyhnuté sada
- H Csillagkulcs készlet

- RO Set chei inelare cu cot
- F Set de clés contre-coudées
- I Set chiavi poligonali doppie piegate
- E Juego de llaves de estrella acodadas
- CN 双头高颈梅花扳手组套

POUCH & COLOR BOX



DIN 838

CrV 6140

AS-DRIVE



8 PCS
6x7, 8x9, 10x11, 12x13, 14x15, 16x17, 18x19, 20x22 mm

10 PCS
6x7, 8x9, 10x11, 12x13, 14x15, 16x17, 18x19, 20x22, 21x23, 24x27 mm

12 PCS
6x7, 8x9, 10x11, 12x13, 14x15, 16x17, 18x19, 20x22, 21x23, 24x27, 25x28, 30x32 mm

YATO	YT-0248	6
------	---------	---

YATO	YT-0250	10
------	---------	----

YATO	YT-0252	4
------	---------	---

1

GB Insulated ring wrench
 D Einringschlüssel vollisoliert
 PL Klucz oczkowy odgięty izolowany
 RUS Ключ накидной односторонний изолированный

CZ Očkový klíč, izolovaný
 H Hajlítotszárú csillagkulcs
 RO Cheie inelara izolata
 F Clé polygonale coudée isolée

I Chiave poligonale piegato isolato
 E Llave de estrella acodada aislante
 CN 绝缘梅花扳手

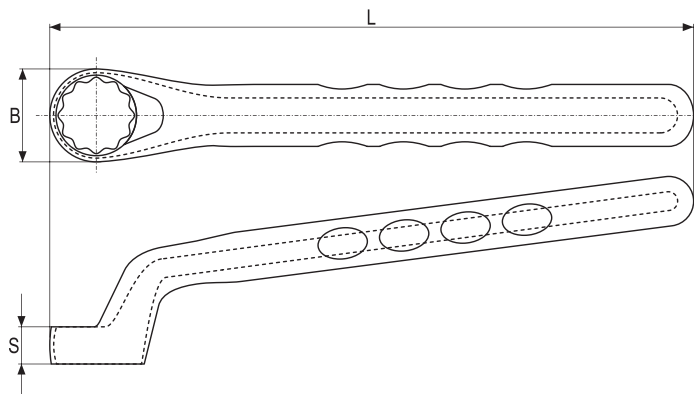

1000V
 VDE CERTIFICATE
 EN 60900:2012

YATO	Ø (mm)	L (mm)	B (mm)	S (mm)		YATO	Ø (mm)	L (mm)	B (mm)	S (mm)	
YT-20980	6	150	16.0	5.5	6/126	YT-20990	16	215	31.0	10.2	6/90
YT-20981	7	150	18.0	5.7	6/126	YT-20991	17	215	32.0	10.7	6/90
YT-20982	8	155	19.0	6.1	6/126	YT-20992	18	230	35.0	11.5	6/90
YT-20983	9	155	20.0	7.2	6/126	YT-20993	19	230	36.0	12.0	6/90
YT-20984	10	170	21.0	7.3	6/90	YT-20994	21	245	39.0	13.0	6/48
YT-20985	11	170	22.5	7.7	6/90	YT-20995	22	245	41.0	12.2	6/48
YT-20986	12	190	22.5	8.5	6/90	YT-20996	24	265	44.0	13.0	6/48
YT-20987	13	190	26.5	9.0	6/90	YT-20997	27	290	48.0	14.5	4/40
YT-20988	14	205	28.0	9.5	6/90	YT-20998	30	310	52.0	15.2	4/40
YT-20989	15	205	29.0	9.5	6/90	YT-20999	32	310	55.0	16.5	4/40

GB Insulated open end wrench
 D Doppelmaulschlüssel isoliert
 PL Klucz płaski izolowany
 RUS Ключ рожковый односторонний изолированный
 CZ Otevřený klíč, izolovaný
 H Villáskulcs
 RO Cheie fixă izolata
 F Clé plate isolée
 I Chiave piatta isolato
 E Llave fija aislante
 CN 绝缘开口扳手

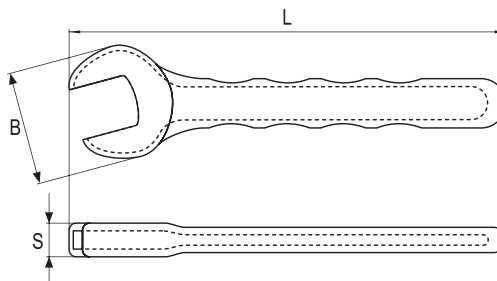
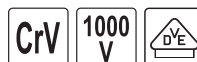

1000V
 VDE CERTIFICATE
 EN 60900:2012

YATO	Ø (mm)	L (mm)	B (mm)	S (mm)		YATO	Ø (mm)	L (mm)	B (mm)	S (mm)	
YT-20950	6	90	23	7.0	6/108	YT-20960	16	160	43	11.5	6/72
YT-20951	7	90	25	7.0	6/108	YT-20961	17	160	47	12.5	6/72
YT-20952	8	100	27	7.5	6/108	YT-20962	18	175	50	13.0	6/72
YT-20953	9	100	29	7.5	6/108	YT-20963	19	175	53	14.0	6/72
YT-20954	10	110	31	8.0	6/108	YT-20964	21	195	55	14.0	6/66
YT-20955	11	110	34	8.5	6/108	YT-20965	22	195	58	14.0	6/66
YT-20956	12	130	36	8.5	6/108	YT-20966	24	225	62	16.5	6/66
YT-20957	13	135	39	10.5	6/108	YT-20967	27	250	69	18.0	4/60
YT-20958	14	145	40	10.5	6/72	YT-20968	30	290	75	19.0	4/48
YT-20959	15	150	42	11.5	6/72	YT-20969	32	310	79	20.0	4/48

- GB Ring impact wrench
D Schlagringschlüssel
PL Klucz do pobijania oczkowy
RUS Ключ закрытый для растряски
CZ Klíč maticový očkový rázový
H Űtőcsillagkulcs
RO Cheie inelară cu bătător
F Clé à frapper à œil
I Chiave poligonale semplice a percussione
E Llave de muletilla para usarse dando golpes
CN 敲击梅花扳手

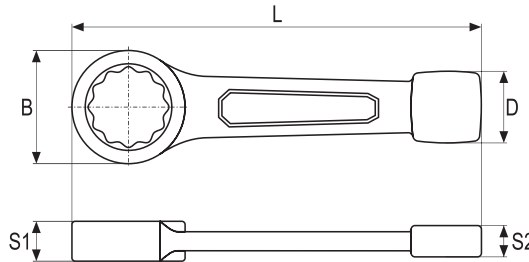

- application: industry
- 12 point profile
- AS-DRIVE system
- drop forged
- surface finish: black oxidised

- przeznaczenie: przemysł
- profil 12-kątny
- system AS-DRIVE
- kute
- wykończenie powierzchni: czarna, oksydowana

YATO	Ø (mm)	L (mm)	B (mm)	D (mm)	S1 (mm)	S2 (mm)	
YT-1601	24	160	41	31	15.0	10	5/25
YT-1602	27	185	47	33	15.0	12	5/25
YT-1603	30	190	51	35	16.5	14	5/25
YT-1604	32	195	54	37	16.5	15	5/25
YT-1605	36	210	60	39	20.0	17	5/10
YT-1606	38	210	60	39	20.0	17	5/10
YT-1607	41	225	66	42	20.0	18	5/10

YATO	Ø (mm)	L (mm)	B (mm)	D (mm)	S1 (mm)	S2 (mm)	
YT-1608	46	240	74	44	22.0	19	5/10
YT-1609	50	250	80	45	23.0	20	5/10
YT-1610	55	270	86	55	25.0	22	5/10
YT-1611	58	270	86	55	25.0	22	5
YT-1612	60	270	92	60	25.0	23	5
YT-1613	65	290	100	65	30.0	24	5
YT-1614	70	310	108	70	32.0	25	5

- GB Open end impact wrench
D Schlagschraubenschlüssel
PL Klucz do pobijania płaski
RUS Ключ плоский для растряски
CZ Klíč maticový plochý rázový
H Űtőlaposkulcs
RO Cheie fixă cu bătător
F Clé à frapper plate
I Chiave a forchetta semplice a percussione
E Llave de boca abierta para usarse dando golpes
CN 敲击开口扳手

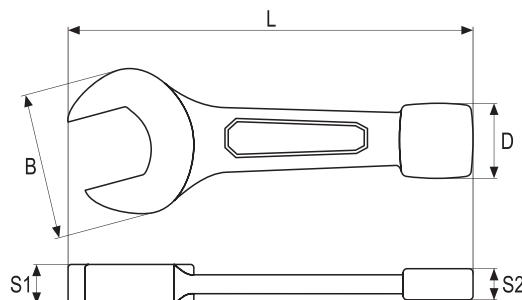

- application: industry
- head offset: 15°
- drop forged
- surface finish: black oxidised

- przeznaczenie: przemysł
- kąt odchylenia główki: 15°
- kute
- wykończenie powierzchni: czarna, oksydowana

YATO	Ø (mm)	L (mm)	B (mm)	D (mm)	S1 (mm)	S2 (mm)	
YT-1615	27	180	55	33	15	12	5/25
YT-1616	30	187	63	35	17	14	5/25
YT-1617	32	195	67	37	18	15	5/25
YT-1618	36	210	77	39	18	17	5/10

YATO	Ø (mm)	L (mm)	B (mm)	D (mm)	S1 (mm)	S2 (mm)	
YT-1619	41	225	89	42	20	18	5/10
YT-1620	46	255	98	44	20	19	5/10
YT-1621	50	280	107	45	22	20	5
YT-1622	55	310	118	55	25	22	5

1

- GB Half-moon spanner
- D Starter- und Blockschlüssel
- PL Klucz oczkowy typu „C”
- RUS Ключ накладной изогнутый „С”
- CZ Klíč očkoploché typ „C”
- H Félhold alakú csillagkulcs
- RO Cheie inelară semi-lună
- F Clé à ceill „C”
- I Chiave poligonale doppio speciale tipo „C”
- E Llave de estrella tipo „C”
- CN C型梅花扳手

CrV 6140 AS-DRIVE

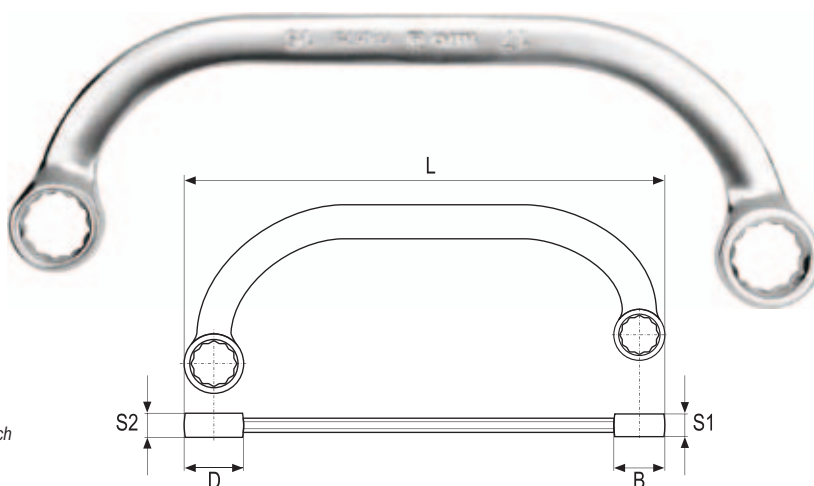

- application: industry
- excellent for work in tight spaces
- used for dismantling of collector tubes, alternators and starters
- surface finish: chromed, satin
- przeznaczenie: przemysł
- do pracy w miejscach szczególnie trudnodostępnych
- ułatwia odkręcanie kolektorów, alternatorów i rozruszników samochodowych
- wykończenie powierzchni: chromowana, satynowa

YATO	Ø (mm)	L (mm)	B (mm)	D (mm)	S1 (mm)	S2 (mm)	PCS
YT-0170	10x12	145	16.8	19.2	6.8	6.8	10/60
YT-0171	11x13	170	18.5	21.2	8.4	8.6	10/60
YT-0172	14x15	195	22.8	25.8	9.2	9.9	10/60

YATO	Ø (mm)	L (mm)	B (mm)	D (mm)	S1 (mm)	S2 (mm)	PCS
YT-0173	16x17	220	26.2	28.6	9.9	10.5	10/60
YT-0175	19x22	260	28.7	32.9	10.4	10.9	10/60

- GB Flare nut wrench
- D Schraubenschlüssel, halboffen
- PL Klucz oczkowy półotwarty
- RUS Ключ накладной полуоткрытый
- CZ Klíč prstencový polootevřený
- H Csuklós, nyitott
- RO Cheie inelară semideschisă
- F Clé mixte à cliquet
- I Chiave poligonale semiaperta
- E Llave semiabierta
- CN 油管扳手

CrV 6140

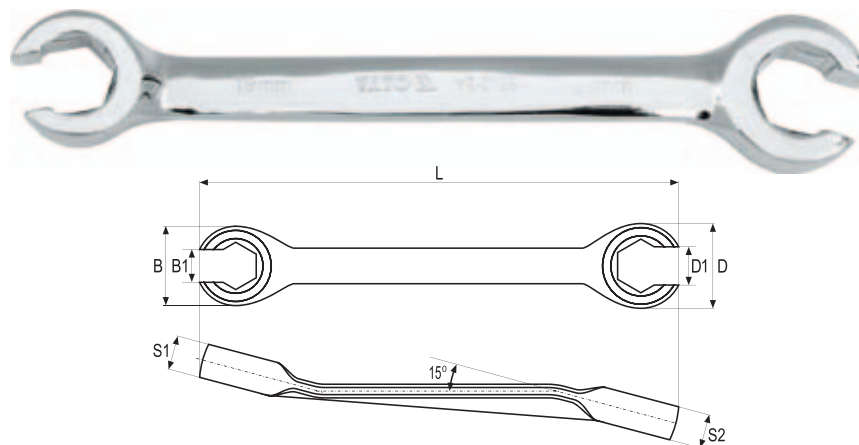

COLOR BOX



YATO	Ø (mm)	L (mm)	B (mm)	D (mm)	B1 (mm)	D1 (mm)	S1 (mm)	S2 (mm)	PCS
YT-0135	8x10	140	18.7	21.8	6.2	7.2	7.7	8.4	10
YT-0136	11x12	160	21.2	24.0	8.1	9.2	8.5	9.5	10
YT-0137	13x14	175	26.3	27.3	9.6	10.7	9.6	10.5	10
YT-0138	15x17	190	31.2	31.2	11.8	13.0	11.5	10.9	10

YATO	Ø (mm)	L (mm)	B (mm)	D (mm)	B1 (mm)	D1 (mm)	S1 (mm)	S2 (mm)	PCS
YT-01385	17x19	195	29.0	31.2	14.5	15.0	12.4	12.8	10
YT-0139	19x21	230	36.3	42.1	14.7	16.7	12.4	12.8	10
YT-0140	22x24	250	42.7	44.2	17.1	18.6	13.2	13.9	10

- GB Flare nut wrench set
- D Schraubenschlüssel, halboffen
- PL Zestaw kluczy oczkowych półotwartych
- RUS Ключ накладной полуоткрытый
- CZ Klíč prstencový polootevřený
- H Csuklós, nyitott
- RO Cheie inelară semideschisă
- F Set de clés à tête fendue
- I Set chiavi poligonali semiaperte
- E Llaves semiabierts
- CN 油管扳手组套

4 PCS CrV 6140



8x10, 11x12, 13x14, 15x17 mm

YATO	PCS
YT-0143	25/50

GB Flexible flare nut wrench
 D Schraubenschlüssel, halboffen mit Gelenk
 PL Klucz oczkowy półotwarty z przegubem
 RUS Ключ накладной полуоткрытый с шарниром
 CZ Klíč prstencový polootevřený s kloubem
 H Csuklós, nyitott csillagkulcs
 RO Cheie inelară semideschisă, cu articulație
 F Clé à tête fendue articulée
 I Chiave poligonale a due bocche aperte con testa snodata
 E Llave semiabierta con una junta
 CN 活头油管扳手

CrV
6140

AS-DRIVE

1

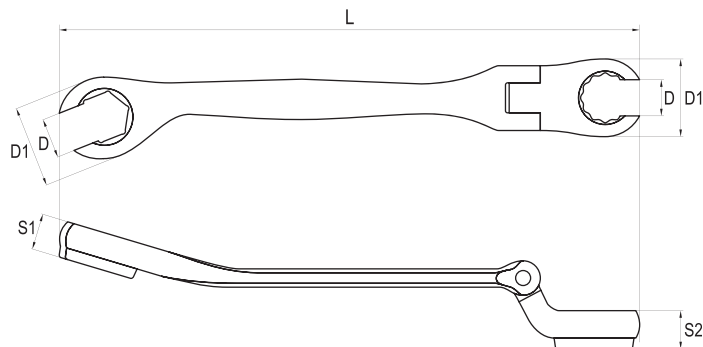

- application: industry
- articulated joint at 12 point head
- ring for nuts in sockets
- for use on hydraulic lines
- for use on fuel lines
- for use on brake system lines
- ergonomic handle
- surface finish: chromed, satin
- przeznaczenie: przemysł
- przegub przy profilu 12-kątnym
- pierścienie do gniazd nakrętek
- do przewodów hydraulicznych
- do przewodów paliwowych
- do przewodów hamulcowych
- ergonomiczna rączka
- wykończenie powierzchni: chromowana, satynowa

PLASTIC
HANGER

YATO	Ø (mm)	L (mm)	D (mm)	D1 (mm)	S1 (mm)	S2 (mm)	
YT-0184	12	148	9.0	22.0	9.0	9.0	24/216
YT-0187	15	175	12.0	26.0	11.0	11.0	12/120

GB Flexible flare nut wrench set
 D Schraubenschlüssel, halboffen mit Gelenk
 PL Komplet kluczy oczkowych półotwartych z przegubem
 RUS Ключ накладной полуоткрытый с шарниром
 CZ Klíč prstencový polootevřený s kloubem
 H Csuklós, nyitott csillagkulcs
 RO Cheie inelară semideschisă, cu articulație
 F Set de clés à tête fendue articulée
 I Set chiavi poligonali a due bocche aperte con testa snodata
 E Llave semiabierta con una junta
 CN 活头油管扳手套

CrV
6140

AS-DRIVE

7
PCSCrV
6140

AS-DRIVE

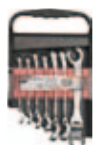
PLASTIC
HANGER

8, 10, 11, 12, 13, 14, 17 mm

YATO	
YT-0190	5/20

1

- GB Torx ring spanner set
- D Torx-Ringschlüsselsatz
- PL Komplet kluczy oczkowych Torx
- RUS Набор накидных ключей
- CZ Očkové klíče
- H Csillagkulcs készlet
- RO Chei inelare
- F Set de clés à œil
- I Set chiavi doppie Torx
- E Llaves de anillo Torx
- CN 星型扳手组套



4 PCS
TORX
CrV 6150

E6xE8, E10xE12, E14xE18, E20xE24

SLIDING CARD

YATO	
YT-0530	10/60

- GB L-type socket wrench
- D Steckschlüssel gebogen
- PL Klucz nasadowy typu „L”
- RUS Ключ торцевой „L” типа
- CZ Nástrčný kľúč fajfkový
- H Kulcs, dugó-pipa
- RO Cheie tubulara cu cot tip „L”
- F Clé à pipe en „L”
- I Chiave a tubo doppio tipo „L”
- E Llave de vaso „L”
- CN L型套筒扳手

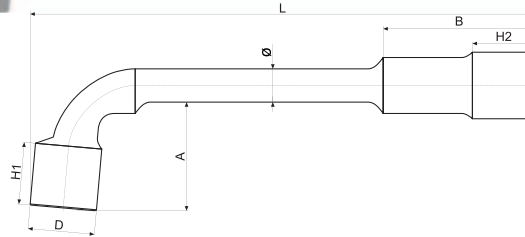

CrV 6140

YATO	Ø (mm)	L (mm)	B (mm)	H1 (mm)	H2 (mm)	A (mm)	D (mm)	Ø (mm)	
YT-1627	7	106	27.0	10.2	10.1	21.0	10.7	7	12/60
YT-1628	8	117	29.5	12.3	11.9	18.5	12.2	9	12/60
YT-1629	9	121	31.7	13.4	12.8	19.1	13.2	10	12/60
YT-1630	10	131	35.1	16.4	16.9	23.3	15.0	10	12/60
YT-1631	11	138	36.0	16.5	16.8	24.7	16.3	11	12/60
YT-1632	12	147	42.5	17.9	18.2	17.9	18.0	12	12/60
YT-1633	13	154	44.2	18.5	19.1	30.1	19.3	12	12/60
YT-1634	14	162	47.0	19.3	20.3	30.2	20.8	13	12/60
YT-1635	15	173	48.9	20.6	21.6	31.6	22.3	13	12/60
YT-1636	16	182	55.0	23.2	23.1	37.3	23.6	14	12/60

YATO	Ø (mm)	L (mm)	B (mm)	H1 (mm)	H2 (mm)	A (mm)	D (mm)	Ø (mm)	
YT-1637	17	188	57.0	25.1	25.5	37.9	25.1	14	12/36
YT-1638	18	192	57.1	25.1	24.6	40.1	26.0	14	12/36
YT-1639	19	207	62.3	26.9	27.4	41.6	28.2	16	12/36
YT-1640	20	215	62.4	27.0	28.3	42.4	29.2	16	6/24
YT-1641	21	221	65.0	30.5	30.6	54.0	30.2	16	6/24
YT-1642	22	232	67.5	30.8	30.6	49.1	31.7	16	6/24
YT-1644	24	253	78.2	32.3	31.7	53.5	33.6	17	6/18
YT-1647	27	288	85.3	36.9	36.4	54.7	37.6	20	6/12
YT-1649	30	310	95.0	38.4	38.6	65.3	42.0	22	6/12
YT-1650	32	339	99.2	40.4	40.5	66.8	43.8	22	6

- GB Double flexible socket wrench
- D Steckschlüssel
- PL Klucz nasadowy przegubowy
- RUS Ключ торцевой
- CZ Nástrčné klíče kloubové
- H Csuklós dugókulcs
- RO Set chei tubulare cu articulație
- F Clé à tube tête articulée
- I Chiave a doppia bussola snodata
- E Llave de vaso articulado
- CN 活头双头套筒扳手

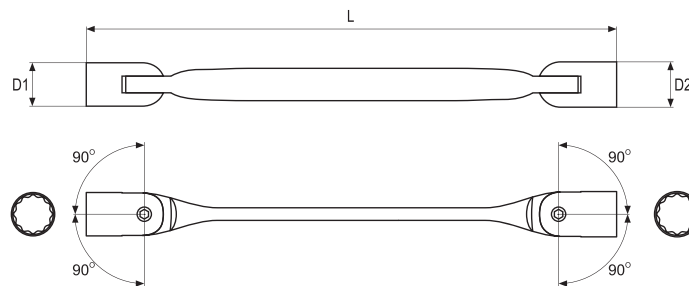

CrV 6140

YATO	Ø (mm)	L (mm)	D1 (mm)	D2 (mm)	PCS packing	
YT-4961	8x9	183	12.9	13.7	10	200
YT-4962	10x11	202	14.6	15.8	10	160
YT-4963	12x13	218	17.6	18.8	10	120

YATO	Ø (mm)	L (mm)	D1 (mm)	D2 (mm)	PCS packing	
YT-4964	14x15	239	19.8	21.7	10	80
YT-4965	16x17	257	23.8	23.9	10	40
YT-4966	18x19	274	25.8	25.8	10	40

COLOR BOX



- GB Heavy duty tubular socket wrench
- D Rohrsteckschlüsselsatz
- PL Klucz rurowy kuty
- RUS Ключ двухлучевой с головками
- CZ Klíče trubkové
- H Csőkulcs
- RO Cheie pt. țevi
- F Clé à tube double droite
- I Chiave a tubo
- E Llave de tubería
- CN 小轮胎扳手



CrV
40 AS-DRIVE

COLOR BOX



YATO	Ø (mm)	D1 (mm)	D2 (mm)	D (mm)	L (mm)	PCS packing:	
YT-4915	8x9	13	14	3	110	10	60/240
YT-4916	10x11	15	16	5	120	10	60/240
YT-4917	12x13	18	19	6	140	10	60/120
YT-4918	14x15	20	22	6	145	10	60/120
YT-4919	16x17	23	24	7	155	10	60/120
YT-4920	18x19	25	26	8	165	5	40/80

YATO	Ø (mm)	D1 (mm)	D2 (mm)	D (mm)	L (mm)	PCS packing:	
YT-4921	20x22	28	30	8	170	5	30/60
YT-4922	21x23	29	31	10	185	5	30/60
YT-4923	24x26	33	35	12	190	5	40
YT-4924	25x28	34	37	12	205	5	40
YT-4925	27x29	37	39	12	210	5	40
YT-4926	30x32	40	42	13	210	5	20

- GB Tubular socket wrench handle
- D Stellstab für Rohr Schlüssel
- PL Pokręto do kluczy rurowych
- RUS Вороток к трубчатым ключам
- CZ Tyčka k trubkovým klíčům
- H Forगतókar dugókulcsához
- RO Clupă pt. chei tubulare
- F Support de clés à tube
- I Spina di manovra per chiave a tubo doppia
- E Mango para las llaves de tubo
- CN 旋棒

CrV
40

COLOR BOX



YATO	L (mm)	mm	PCS packing:	
YT-4927	190	2.5; 4.5; 5.5	50	150
YT-4928	280	6.5; 7.5; 9.5; 11.5; 12.5	50	100

- GB Ratchet wrench
- D Gerüstratsche
- PL Klucz nasadowy z grzechotką
- RUS Ключ торцовый с трещоткой
- CZ Ráčnový klíč průchozí
- H Kettős racsnis kulcs
- RO Cheie tubulara cu clichet
- F Clé à tube à cliquet
- I Chiavi a cricchetto per ponteggi
- E Llave de vaso con carraca
- CN 尖尾棘轮扳手

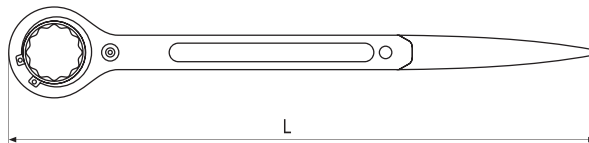

CrV 32T RATCHET WRENCH COLD FORGED KUTE NA ZIMNO



PLASTIC HANGER

YATO	Ø (mm)	L (mm)	
YT-4937	19x22	315	2/40

- GB Double ratchet wrench
- D Gerüstratsche
- PL Dwustronny klucz nasadowy z grzechotką
- RUS Ключ торцовый с трещоткой
- CZ Ráčnový klíč průchozí dvoustranný
- H Kettős racsnis kulcs
- RO Cheie tubulara dubla cu clichet
- F Clé à œil à cliquet
- I Chiave a cricco doppio
- E Llave de vaso con carraca
- CN 尖尾棘轮扳手

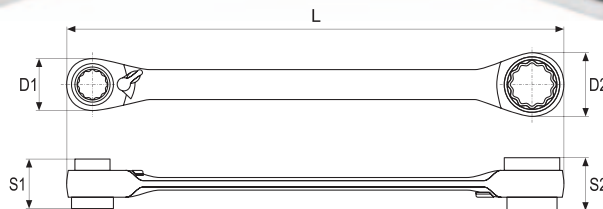

CrV 72T RATCHET WRENCH



DOUBLE BLISTER

YATO	Ø (mm)	L (mm)	D1 (mm)	D2 (mm)	S1 (mm)	S2 (mm)	
YT-4945	10x13x17x19	200	29	35	17	22	5/50

- GB Socket wrench with handle
- D Steckschlüssel
- PL Klucz nasadowy z rączką
- RUS Ключ торцевой
- CZ Nástrčný klíč
- H Kulcs
- RO Cheie tubulara
- F Clé à tube
- I Chiave a cricco doppio
- E Llave
- CN 六角套筒螺丝批

COLOR BOX



CrV HRC 44

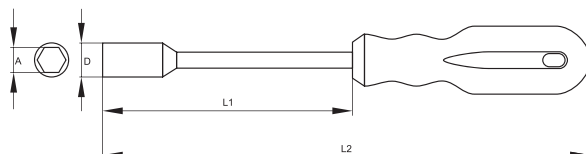

YATO	Ø (mm)	D (mm)	L1 (mm)	L2 (mm)	PCS packing:	
YT-1541	5	8.0	125	242	6	120
YT-1542	6	9.1	125	242	6	120
YT-1543	7	10.9	125	242	6	120
YT-1544	8	12.0	125	242	6	120
YT-1545	9	13.0	125	242	6	120
YT-1546	10	14.1	125	242	6	120
YT-1547	11	15.9	125	242	6	120
YT-1548	12	16.9	125	242	6	120
YT-1549	13	18.0	125	242	6	120

1

GB T-type deep socket wrench with rotary handle
D Steckschlüssel vom Typ „T“ mit drehbarem Handgriff
PL Klucz nasadowy typu „T“ z obrotową rękojeścią
RUS Торцовый ключ типа „Т“ с вращательной ручкой
CZ Klič nástrčný typ „T“ s otočnou rukojeťou

H „T“ típusú dugókulcs, forgatható karral
RO Cheie tubulară de tip „T“ cu mâner rotativ
F Clé à tube
I Chiave tipo „T“ con manico scorrevole
E Llave tubular „T“ con un mango giratorio
CN T型套筒扳手



CrV
6140
AS-DRIVE

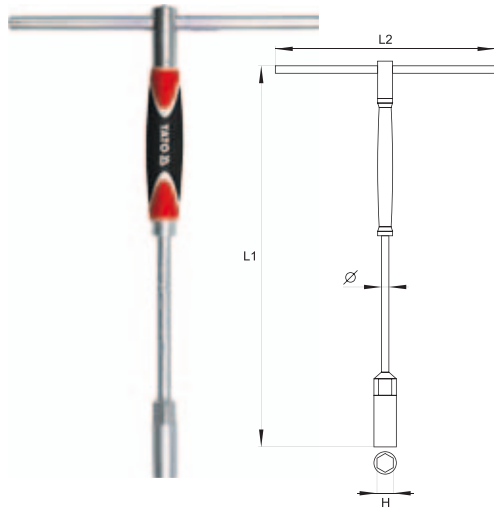

- ergonomic handle
- movable handle with position locking system
- long bar for work in deep set, difficult to reach places

- ergonomiczna rękojeść
- przesuwane pokrętko z blokadą położenia
- długi trzpień umożliwiający pracę w głębokich wnękach

YATO	Ø H	L1 (mm)	L2 (mm)	Ø (mm)	
YT-1552	8 mm	310	200	10	10/40
YT-1553	9 mm	310	200	10	10/40
YT-1554	10 mm	310	200	10	10/40
YT-1555	11 mm	310	200	10	10/40
YT-1556	12 mm	310	200	10	10/40
YT-1557	13 mm	310	200	10	10/40
YT-1558	14 mm	310	200	10	10/40
YT-1559	15 mm	310	200	10	10/40

GB Insulated T-handle wrench
D Steckschlüssel T-griff vollisoliert
PL Rękojeść typu „T“ izolowana
RUS Ручка Т-образная изолированная
CZ Klič nástrčný typ „T“, izolovaný

H „T“ típusú dugókulcs
RO Maner tip „T“ izolat
F Clé à tube en „T“ isolée
I Chiave a bussola tipo „T“ isolati
E Llave tubular „T“ aislante
CN 绝缘T型扳手

3/8"
10mm
1/2"
12.5mm
CrV
1000
V

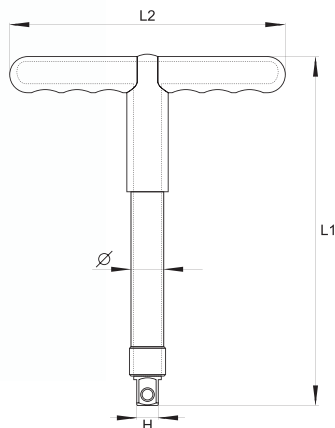

1000V
VDE CERTIFICATE
EN 60900:2012

YATO	Ø H	L1 (mm)	L2 (mm)	Ø (mm)	
YT-21095	3/8" (9.5 mm)	207	160	15.6	4/32
YT-21096	1/2" (12.7 mm)	207	160	19.3	4/32

GB T-type adapter with rotary handle
D Adapter vom Typ „T“ mit drehbarem Handgriff
PL Adapter typu „T“ z obrotową rękojeścią
RUS Адаптер типа „Т“ с вращательной ручкой
CZ Adaptér typ „T“ s otočnou rukojeťou
H „T“ típusú adapter, forgatható karral
RO Adaptor tip „T“ cu mâner rotativ
F Adapteur
I Adattatore tipo „T“ con manico scorrevole
E Adaptador „T“ con un mango giratorio
CN T型套筒扳手



1/4"
6.3mm
3/8"
10mm
1/2"
12.5mm
CrV
6140

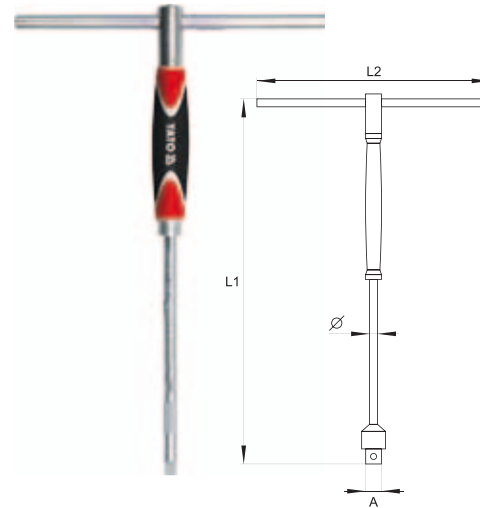

- ergonomic handle
- movable handle with position locking system
- long bar for work in deep set, difficult to reach places

- ergonomiczna rękojeść
- przesuwane pokrętko z blokadą położenia
- długi trzpień umożliwiający pracę w głębokich wnękach

YATO	Ø H	L1 (mm)	L2 (mm)	Ø (mm)	
YT-1565	1/4" (6.3 mm)	310	200	8	10/40
YT-1566	3/8" (9.5 mm)	310	200	10	10/40
YT-1567	1/2" (12.7 mm)	310	200	10	10/40

GB T-type deep socket wrench
D Steckschlüssel vom Typ „T“
PL Klucz nasadowy typu „T“
RUS Торцовый ключ типа „Т“
CZ Klič nástrčný typ „T“
H „T“ típusú dugókulcs

RO Cheie tubulară de tip „T“
F Clé à tube en „T“
I Chiave a bussola tipo „T“
E Llave tubular „T“
CN T型套筒扳手

CrV
6140
AS-DRIVE

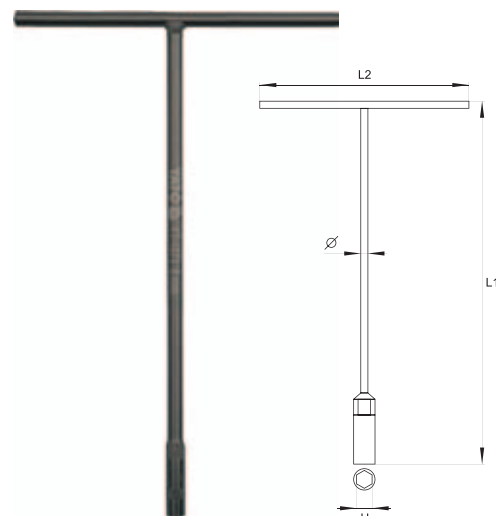

YATO	Ø H	L1 (mm)	L2 (mm)	Ø (mm)	
YT-1571	8 mm	310	200	10	10/40
YT-1572	9 mm	310	200	10	10/40
YT-1573	10 mm	310	200	10	10/40
YT-1574	11 mm	310	200	10	10/40
YT-1575	12 mm	310	200	10	10/40
YT-1576	13 mm	310	200	10	10/40
YT-1577	14 mm	310	200	10	10/40
YT-1578	15 mm	310	200	10	10/40

GB Adjustable wrench
D Rollgabelschlüssel
PL Klucz nastawny
RUS Ключ разводной

CZ Nastavitelný klíč
H Állítható svédkulcs
RO Cheie reglabilă
F Clé à molette

I Chiave a rullino graduata
E Llave ajustable
tipo inglesa
CN 活络扳手

150 mm 200 mm 250 mm 300 mm 375 mm



HALF
DOUBLE
BLISTER



YATO	L (mm)	
YT-2071	150	6/60
YT-2072	200	6/60
YT-2073	250	6/36
YT-2074	300	6/24
YT-2075	375	6/12

GB Adjustable wrench
D Rollgabelschlüssel
PL Klucz nastawny
RUS Ключ разводной

CZ Nastavitelný klíč
H Állítható svédkulcs
RO Cheie reglabilă
F Clé à molette

I Chiave a rullino graduata
E Llave ajustable
tipo inglesa
CN 活络扳手

150 mm 200 mm 250 mm 300 mm DIN 3117 CrV



HALF
DOUBLE
BLISTER



YATO	L (mm)	
YT-2165	150	6/120
YT-2166	200	6/60
YT-2167	250	6/36
YT-2168	300	6/24

GB Adjustable wrench
D Rollgabelschlüssel
PL Klucz nastawny
RUS Ключ разводной

CZ Nastavitelný klíč
H Állítható svédkulcs
RO Cheie reglabilă
F Clé à molette

I Chiave a rullino graduata
E Llave ajustable
tipo inglesa
CN 活络扳手

150 mm 200 mm 250 mm 300 mm DIN 3117 CrV



HALF
DOUBLE
BLISTER



YATO	L (mm)	
YT-2170	150	6/72
YT-2171	200	6/60
YT-2172	250	6/48
YT-2173	300	6/36

GB Adjustable wrench
D Rollgabelschlüssel
PL Klucz nastawny
RUS Ключ разводной

CZ Nastavitelný klíč
H Állítható svédkulcs
RO Cheie reglabilă
F Clé à molette

I Chiave a rullino graduata
E Llave ajustable
tipo inglesa
CN 活络扳手

150 mm 200 mm 250 mm 300 mm 375 mm DIN 3117 DROP FORGED KUTE



HALF
DOUBLE
BLISTER



YATO	L (mm)	opening capacity (mm) zakres rozwarcia szczęk (mm)	
YT-21650	150	19.3	6/36
YT-21651	200	24.0	6/36
YT-21652	250	30.0	6/36
YT-21653	300	36.0	6/24
YT-21654	375	45.0	2/16

GB Insulated adjustable wrench
D Rollgabelschlüssel isoliert
PL Klucz nastawny izolowany
RUS Ключ разводной изолированный
CZ Izolovaný stavitelný klíč
H Állítható svédkulcs

RO Cheie reglabilă izolată
F Clé à molette isolée
I Isolati chiave regolabile
E Llave ajustable aislante
CN 绝缘活络扳手

200 mm 250 mm 300 mm CrV 1000 V D'E



1000V
VDE CERTIFICATE
EN 60900:2012

YATO	L (mm)	
YT-20940	200	6/48
YT-20941	250	6/36
YT-20942	300	4/24

2

Sockets, accessories & sets
Klucze nasadowe,
akcesoria i zestawy



Sockets 1/4" Klucze nasadowe 1/4"		25
---	---	----

Hexagonal sockets Klucze nasadowe sześciokątne, krótkie	25
Hexagonal deep sockets Klucze nasadowe sześciokątne, długie	25

Accessories 1/4" Akcesoria 1/4"		25-26
---	---	-------

Extension bars Przedłużki	25
Extension bars with wobble Przedłużki uchyłne	25
Flexible extension cords Przedłużki elastyczne	26
Adapters Redukcje	26
Bit adapters Adaptory do bitów	26
Universal joints Przeguby Cardana	26
Spinner handles Pokręta do nasadek	26
Sliding T-bars Pokręta typu „T”	26
Flexible handles Pokręta łamane	26

Ratchet handles 1/4" Grzechotki 1/4"		27-28
--	---	-------

Ratchet handles Grzechotki	27
Flexible ratchet handles Grzechotki z przegubem	27
Composite ratchet handles Grzechotki powlekane	27
Curved ratchet handles Grzechotki wygięte	28
Telescopic ratchet handles Grzechotki z przedłużonym uchwytem	28
Bit and socket drive ratchet handles Grzechotki do bitów i nasadek	28
Rotary head ratchet handles Grzechotki z obrotową głowicą	28

Sockets 3/8" Klucze nasadowe 3/8"		29
---	---	----

Hexagonal sockets Klucze nasadowe sześciokątne, krótkie	29
Insulated hexagonal sockets Klucze nasadowe sześciokątne izolowane, krótkie	29
Hexagonal deep sockets Klucze nasadowe sześciokątne, długie	29

Accessories 3/8" Akcesoria 3/8"		29-31
---	---	-------

Extension bars Przedłużki	29
Insulated extension bars Przedłużki izolowane	30

Extension bars with wobble Przedłużki uchyłne	30
Adapters Redukcje	30
Bit adapters Adaptory do bitów	30
Universal joints Przeguby Cardana	30
Sliding T-bars Pokręta typu „T”	30
Flexible handles Pokręta łamane	31
Spark plug sockets Klucze nasadowe do świec	31

Ratchet handles 3/8" Grzechotki 3/8"		31-33
--	---	-------

Ratchet handles Grzechotki	31
Flexible ratchet handles Grzechotki z przegubem	32
Composite ratchet handles Grzechotki powlekane	32
Insulated ratchet handles Grzechotki izolowane	32
Curved ratchet handles Grzechotki wygięte	33
Telescopic ratchet handles Grzechotki z przedłużonym uchwytem	33











Sockets 1/2" Klucze nasadowe 1/2"		34-35
---	--	-------

Hexagonal sockets Klucze nasadowe sześciokątne, krótkie	34
Insulated hexagonal sockets Klucze nasadowe sześciokątne izolowane, krótkie	34
Bi-hexagonal sockets Klucze nasadowe dwunastokątne, krótkie	34
Spline sockets Klucze nasadowe „Spline”	35
Hexagonal deep sockets Klucze nasadowe sześciokątne, długie	35

Accessories 1/2" Akcesoria 1/2"		36-37
---	---	-------

Extension bars Przedłużki	36
Insulated extension bars Przedłużki izolowane	36
Extension bars with wobble Przedłużki uchyłne	36
Adapters Redukcje	36
Bit adapters Adaptory do bitów	36
Universal joints Przeguby Cardana	37
Sliding T-bars Pokręta typu „T”	37
Flexible handles Pokręta łamane	37
L-type handles Pokręta typu „L”	37
Spark plug sockets Klucze nasadowe do świec	37



<p>Ratchet handles 1/2" Grzechotki 1/2"</p> <p style="text-align: right;">38-39 </p>	<p>Torx sockets & sets Klucze nasadowe „Torx” i zestawy</p> <p style="text-align: right;">71 </p>
<p>Ratchet handles Grzechotki..... 38</p> <p>Flexible ratchet handles Grzechotki z przegubem..... 38</p> <p>Composite ratchet handles Grzechotki powlekane..... 38</p> <p>Insulated ratchet handles Grzechotki izolowane..... 38</p> <p>Curved ratchet handles Grzechotki wygięte..... 39</p> <p>Telescopic ratchet handles Grzechotki z przedłużonym uchwytem..... 39</p> <p>Rotary head ratchet handles Grzechotki z obrotową głowicą..... 39</p> <p>Step wrenches Klucze sztorcowe..... 39</p>	<p>Go-trough socket sets 1/2" Zestawy kluczy nasadowych, przelotowych 1/2"</p> <p style="text-align: right;">71 </p> <p>Sockets 3/4" Klucze nasadowe 3/4"</p> <p style="text-align: right;">72 </p> <p>Accessories 3/4" Akcesoria 3/4"</p> <p style="text-align: right;">72-73 </p>
<p>Socket sets Zestawy kluczy nasadowych</p> <p style="text-align: right;">40-52 </p> <p>Socket sets 1/4" Zestawy kluczy nasadowych 1/4"..... 40</p> <p>Socket sets 3/8" Zestawy kluczy nasadowych 3/8"..... 43</p> <p>Socket sets 1/2" Zestawy kluczy nasadowych 1/2"..... 43</p> <p>Socket sets 1/2", 1/4" Zestawy kluczy nasadowych 1/2", 1/4"..... 45</p> <p>Socket sets 1/2", 3/8", 1/4" Zestawy kluczy nasadowych 1/2", 3/8", 1/4"..... 48</p>	<p>Extension bars Przedłużki..... 72</p> <p>Adapters Redukcje..... 72</p> <p>Universal joints Przeguby Cardana..... 72</p> <p>Sliding T-bars Pokrętła typu „T”..... 72</p> <p>Flexible handles Pokrętła łamane..... 73</p> <p>L-type handles Pokrętła typu „L”..... 73</p> <p>Ratchet handles 3/4" Grzechotki 3/4"</p> <p style="text-align: right;">73 </p>
<p>Socket sets Zestawy kluczy nasadowych</p> <p style="text-align: right;">53-69 </p> <p>Socket sets 1/4" Zestawy kluczy nasadowych 1/4"..... 53</p> <p>Socket sets 3/8" Zestawy kluczy nasadowych 3/8"..... 57</p> <p>Socket sets 1/2" Zestawy kluczy nasadowych 1/2"..... 59</p> <p>Socket sets 1/2", 1/4" Zestawy kluczy nasadowych 1/2", 1/4"..... 62</p> <p>Socket sets 1/2", 3/8", 1/4" Zestawy kluczy nasadowych 1/2", 3/8", 1/4"..... 66</p>	<p>Socket sets 3/4" Zestawy kluczy nasadowych 3/4"</p> <p style="text-align: right;">73 </p> <p>Bit sockets & sets 1/4", 3/8", 1/2" Klucze trzpieniowe i zestawy 1/4", 3/8", 1/2"</p> <p style="text-align: right;">74-76 </p>
<p>Tool sets Zestawy narzędziowe</p> <p style="text-align: right;">70 </p>	

GB Hexagonal socket
 D Sechskantenschlüssel
 PL Nasadka sześciokątna
 RUS Головка шестигранная короткая
 CZ Šestihřanný nástavec
 H Hatszögű rátét
 RO Cheie tubulară hexagonală
 F Douille courte
 I Chiave a bussola esagonale
 E Boquilla hexagonal corta
 CN 六角套筒

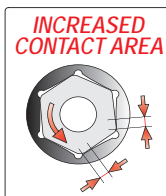

1/4"
 6.3mm
 DIN 3121
 CrV 50BV30
 AS-DRIVE

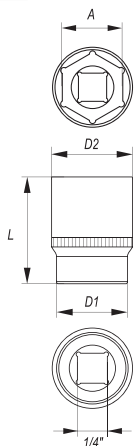

- drive locks
- surface finish: chromed, satin / mirror
- zamki blokujące
- wykończenie powierzchni: chromowana, satynowa / polerowana

YATO	∅ A (mm)	D1 (mm)	D2 (mm)	L (mm)	PCS packing	
YT-1401	4.0	7.0	12.0	25	24	240/480
YT-1403	5.0	8.0	12.0	25	24	240/480
YT-1404	5.5	8.5	12.0	25	24	240/480
YT-1405	6.0	9.0	12.0	25	24	240/480
YT-1406	7.0	10.0	12.0	25	24	240/480
YT-1407	8.0	12.0	11.0	25	24	240/480
YT-1408	9.0	13.0	12.0	25	24	240/480
YT-1409	10.0	15.0	12.0	25	24	240/480
YT-1410	11.0	16.0	14.0	25	24	240/480
YT-1411	12.0	17.0	15.0	25	24	240/480
YT-1412	13.0	18.0	16.0	25	24	240/480



GB Hexagonal deep socket
 D Sechskantenschlüssel, lange
 PL Nasadka sześciokątna długa
 RUS Головка шестигранная длинная
 CZ Šestihřanný hluboký nástavec
 H Hatszögű rátét mély
 RO Cheie tubulară hexagonală adâncă
 F Douille longue
 I Chiave a bussola esagonale
 E Boquilla hexagonal larga
 CN 六角长套筒

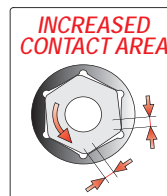

1/4"
 6.3mm
 DIN 3121
 CrV 50BV30
 AS-DRIVE

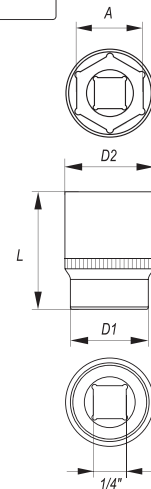

- drive locks
- surface finish: chromed, satin / mirror
- zamki blokujące
- wykończenie powierzchni: chromowana, satynowa / polerowana

YATO	∅ A (mm)	D1 (mm)	D2 (mm)	L (mm)	PCS packing	
YT-1413	4.0	7.0	12.0	50	24	240/480
YT-1414	4.5	7.5	12.0	50	24	240/480
YT-1415	5.0	8.0	12.0	50	24	240/480
YT-1416	5.5	8.5	12.0	50	24	240/480
YT-1417	6.0	9.0	12.0	50	24	240/480
YT-1418	7.0	10.0	12.0	50	24	240/480
YT-1419	8.0	12.0	12.0	50	24	240/480
YT-1420	9.0	13.0	12.0	50	24	240/480
YT-1421	10.0	14.0	13.0	50	24	240/480
YT-1422	11.0	16.0	14.0	50	24	120/240
YT-1423	12.0	17.0	15.0	50	24	120/240
YT-1424	13.0	18.0	16.0	50	24	120/240



GB Extension bar
 D Verlängerung
 PL Przedłużka
 RUS Удлинитель для воротка
 CZ Prodlužovací přípravek
 H Toldalék
 RO Prelungitor
 F Rallonge
 I Prolunga
 E Tubo de prolongación
 CN 接杆

1/4"
 6.3mm
 DIN 3121
 CrV 50BV30

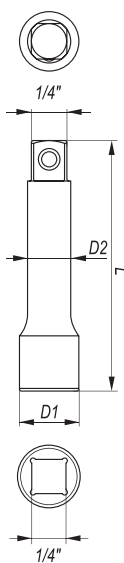

YATO	∅	D1 (mm)	D2 (mm)	L (mm)	PCS packing	
YT-1429	1/4" (6.3 mm)	12.4	8.3	50.8	30	150/300
YT-1430	1/4" (6.3 mm)	12.4	8.3	76.0	30	150/300
YT-1431	1/4" (6.3 mm)	12.4	8.3	101.6	20	100/200
YT-1432	1/4" (6.3 mm)	12.4	8.3	152.4	20	100/200

GB Extension bar with wobble
 D Gelenkverlängerung
 PL Przedłużka uchylna
 RUS Удлинитель наклонный
 CZ Odchylný prodlužovací přípravek
 H Csuklós toldalék
 RO Prelungitor rabatabil
 F Rallonge angulaire
 I Prolunga
 E Tubo de prolongación desviable
 CN 转向接杆

1/4"
 6.3mm
 DIN 3121
 CrV 50BV30

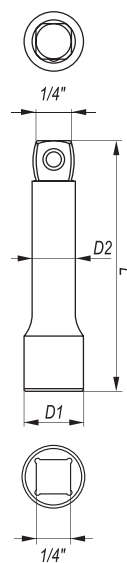

YATO	∅	D1 (mm)	D2 (mm)	L (mm)	PCS packing	
YT-1433	1/4" (6.3 mm)	12.4	8.3	50.8	30	150/300
YT-1434	1/4" (6.3 mm)	12.4	8.3	76.0	30	150/300
YT-1435	1/4" (6.3 mm)	12.4	8.3	101.6	20	100/200
YT-1436	1/4" (6.3 mm)	12.4	8.3	152.4	20	100/200

GB Extension bar
D Verlängerung
PL Przedłużka elastyczna
RUS Удлинитель для воротка

CZ Prodlužovací přípravek
H Toldalék
RO Prelungitor
F Rallonge élastique

I Prolunga flessibile
E Tubo de prolongación
CN 可弯式接杆

1/4"
6.3mm
CrV
6140

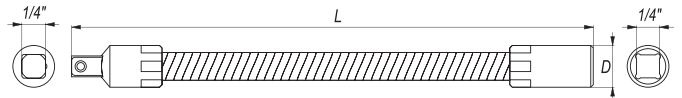

YATO	Ø	Ø	D (mm)	L (mm)	PCS packing	Box
YT-1400	1/4" (6.3 mm)	1/4" (6.3 mm)	11.6	150	25	250/500

GB Adapter
D Reduktion
PL Redukcja
RUS Переходник
CZ Redukce
H Redukció
RO Reducție
F Réduction
I Riduttore
E Reducción
CN 转换头

1/4"
6.3mm
DIN
3121
CrV
50BV30

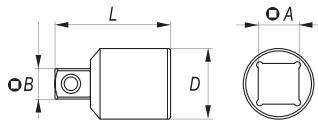

YATO	Ø A	Ø B	D (mm)	L (mm)	PCS packing	Box
YT-1438	1/4" (6.3 mm) (F)	3/8" (9.5 mm) (M)	12	25	10	250/500

GB Bit adapter
D Bithalter
PL Adapter do bitów
RUS Держатель винтовёртовых наконечников
CZ Držák na šroubovakové koncovky
H Szár a csavarhűzővégekhez
RO Capete șurubelniță
F Adapteur d'embouts
I Chiave esagonale a bussola
E Mandril para puntas
CN 旋具头接头

1/4"
6.3mm
CrV
6140

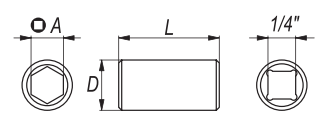

YATO	Ø	Ø A	D (mm)	L (mm)	PCS packing	Box
YT-1297	1/4" (6.3 mm)	1/4" (6.3 mm)	11.8	24	10	250/500

GB Universal joint
D Kardangelen
PL Przegub Cardana
RUS Карданный шарнир
CZ Kardanový kloub
H Kárdán csukló

RO Articulație Cardanică
F Cardan
I Snodo cardanico
E Articulación Cardan
CN 万向接头

1/4"
6.3mm
DIN
3121
CrV
50BV30

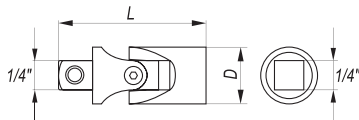

YATO	Ø	D (mm)	L (mm)	PCS packing	Box
YT-1437	1/4" (6.3 mm)	14	35	20	120/240

GB Spinner handle
D Drehgriff für steckschlüssel
PL Pokrętko do nasadek
RUS Ручка с соединением под головки
CZ Nástavec ruční na bity
H Csavarhűzős hajtószer

RO Prelungitor antrenor pt. biti
F Barre
I Porta bussola con manico
E Destornillador con cuadradillo
CN 旋柄

1/4"
6.3mm
CrV
50BV30



YATO	Ø	L (mm)	PCS packing	Box
YT-1427	1/4" (6.3 mm)	150	12	48

GB Sliding T-bar
D Handgriff mit Gleitstück
PL Pokrętko typu „T”
RUS Вороток T-образный
CZ Otočná račka typ „T”

H „T” alakú hajtókar
RO Mâner clupă tipul „T”
F Barre type „T”
I Manopola „T” scorrevole
E Mango tipo „T”
CN 滑杆

1/4"
6.3mm
DIN
3121
CrV
50BV30

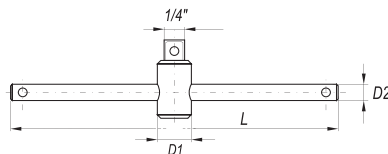

YATO	Ø	D1 (mm)	D2 (mm)	L (mm)	PCS packing	Box
YT-1426	1/4" (6.3 mm)	13.3	6.3	152.4	10	100/200

GB Flexible handle
D Gelenkgriff
PL Pokrętko lamane
RUS Вороток шарнирный
CZ Otočná lomená ráčka
H Hajlított hajtókar

RO Prelungitor cu prindere flexibilă
F Barre pivotante
I Manopola a snodo
E Mango articulada
CN 转向手柄

1/4"
6.3mm
DIN
3121
CrV
50BV30

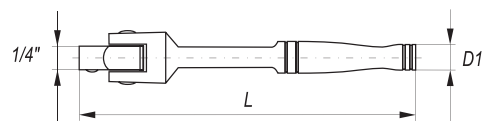

YATO	Ø	D (mm)	L (mm)	PCS packing	Box
YT-1425	1/4" (6.3 mm)	13	140	10	100/200

GB Quick release ratchet handle
D Hebelumschaltknarre
PL Grzechotka
RUS Трещотка
CZ Řehtačka
H Racsnis hajtókar

RO Dispozitiv de prindere cu clichet
F Clé à cliquet
I Cricchetto bussola
E Carraca
CN 快速脱落棘轮扳手

PLASTIC HANGER



12 PCS



COLOR BOX

1/4"
6.3mm

DIN
3122

QUICK
RELEASE
SZYBKO-
ZŁĄCZE

72T

CrV
6140



YATO	Ø	T	L (mm)	PCS packing:	
YT-0307	1/4" (6.3 mm)	72	146	12	24/96

YATO	Ø	T	L (mm)	PCS packing:	
YT-0310	1/4" (6.3 mm)	72	125	12	36/72

YATO	Ø	T	L (mm)	PCS packing:	
YT-0313	1/4" (6.3 mm)	72	125	12	24/96



YATO	Ø	T	L (mm)	PCS packing:	
YT-0316	1/4" (6.3 mm)	72	145	12	24/96

YATO	Ø	T	L (mm)	PCS packing:	
YT-0319	1/4" (6.3 mm)	72	145	12	48/96

YATO	Ø	T	L (mm)	PCS packing:	
YT-0322	1/4" (6.3 mm)	72	148	12	48/96

GB Quick release ratchet handle
D Hebelumschaltknarre
PL Grzechotka
RUS Трещотка
CZ Řehtačka
H Racsnis hajtókar

RO Dispozitiv de prindere cu clichet
F Clé à cliquet
I Cricchetto bussola
E Carraca
CN 快速脱落棘轮扳手

PLASTIC HANGER



12 PCS



COLOR BOX

1/4"
6.3mm

DIN
3122

QUICK
RELEASE
SZYBKO-
ZŁĄCZE

72T

CrV
6140

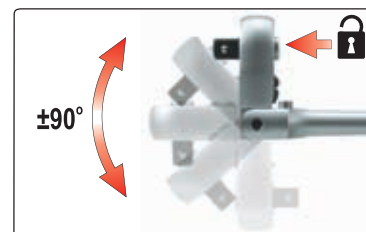

YATO	Ø	T	L (mm)	PCS packing:	
YT-0325	1/4" (6.3 mm)	72	159	12	48/96

GB Quick release ratchet handle
D Hebelumschaltknarre
PL Grzechotka powlekana
RUS Трещотка
CZ Řehtačka
H Racsnis hajtókar

RO Dispozitiv de prindere cu clichet
F Clé à cliquet
I Cricchetto bussola
E Carraca
CN 快速脱落棘轮扳手

PLASTIC HANGER



12 PCS



COLOR BOX

1/4"
6.3mm

DIN
3122

QUICK
RELEASE
SZYBKO-
ZŁĄCZE

72T

CrV
6135



YATO	Ø	T	L (mm)	PCS packing:	
YT-0290	1/4" (6.3 mm)	72	144	12	48/96

YATO	Ø	T	L (mm)	PCS packing:	
YT-0293	1/4" (6.3 mm)	72	144	12	48/96

GB Quick release ratchet handle
 D Hebelumschaltknarre
 PL Grzechotka
 RUS Трещотка
 CZ Řehtačka
 H Racsnis hajtókar
 RO Dispozitiv de prindere cu clichet
 F Clé à cliquet
 I Cricchetto bussola
 E Carraca
 CN 快速脱落棘轮扳手

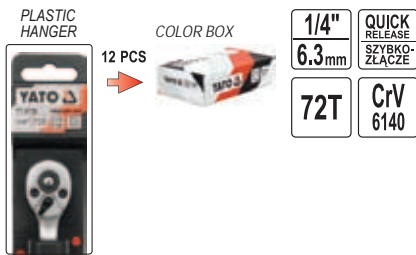

1/4" QUICK RELEASE SZYBKO-ZŁĄCZE
 6.3mm
 72T CrV 6140



YATO	Ø	T	L (mm)	PCS packing	
YT-0730	1/4" (6.3 mm)	72	155	12	24/96

GB Quick release ratchet handle
 D Hebelumschaltknarre
 PL Grzechotka
 RUS Трещотка
 CZ Řehtačka
 H Racsnis hajtókar
 RO Dispozitiv de prindere cu clichet
 F Clé à cliquet
 I Cricchetto bussola
 E Carraca
 CN 快速脱落棘轮扳手

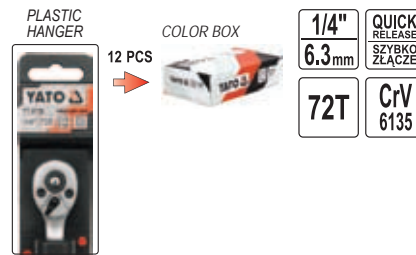

1/4" QUICK RELEASE SZYBKO-ZŁĄCZE
 6.3mm
 72T CrV 6135



YATO	Ø	T	L (mm)	PCS packing	
YT-0733	1/4" (6.3 mm)	72	155	12	24/96

GB Telescopic ratchet handle
 D Umschaltknarre
 PL Grzechotka z przedłużanym uchwytem
 RUS Трещотка
 CZ Řehtačka
 H Racsnis hajtókar
 RO Antrenor cu clichet
 F Clé à cliquet
 I Cricchetto bussola
 E Carraca telescópico
 CN 可伸缩快速脱落棘轮扳手

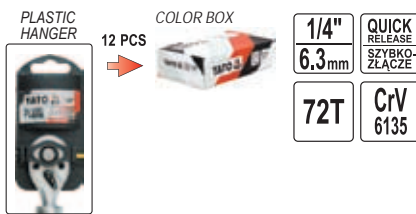

1/4" QUICK RELEASE SZYBKO-ZŁĄCZE
 6.3mm
 72T CrV 6135



YATO	Ø	T	L (mm)	PCS packing	
YT-0297	1/4" (6.3 mm)	72	150-200	12	48

GB Ratchet handle and bit drive
 D Bit- und Steckschlüssel-Umschaltknarre
 PL Grzechotka do bitów i nasadek
 RUS Трещотка для битов и головок
 CZ Ráčna kombinovaná pro bity a nástrčné kľíče
 H Bit és dugófej behajtó racsnis hajtókar
 RO Antrenor cu clichet / antrenor pt. biti
 F Clé à cliquet
 I Cricchetto bussola per punte e snodi
 E Carraca para boquillas y puntas
 CN 套筒旋具两用棘轮扳手

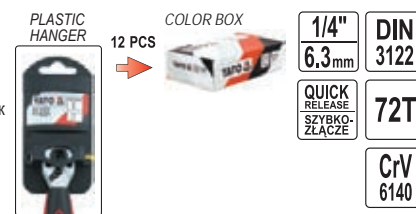

1/4" DIN 3122
 6.3mm
 QUICK RELEASE SZYBKO-ZŁĄCZE
 72T CrV 6140



YATO	Ø	T	L (mm)	PCS packing	
YT-0331	1/4" (6.3 mm)	72	136	12	48

GB Swivel ratchet handle for bits and sockets
 D Umschaltknarre mit Außenvierkanttrieb
 PL Grzechotka z obrotową głowicą do bitów i nasadek
 RUS Трещетка реверсивная
 CZ Ráčna s otočnou hlavou
 H Forgófejes racsnis szár
 RO Antrenor cu clichet flexibil
 F Clé à cliquet tête pivotante
 I Cricchetto bussola per punte e snodi
 E Carraca con cabeza giratoria
 CN 旋轉頭套筒旋具兩用棘輪扳手

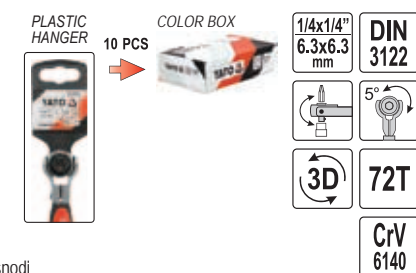

1/4x1/4" DIN 3122
 6.3x6.3 mm
 5°
 3D
 72T CrV 6140



YATO	Ø	T	L (mm)	PCS packing	
YT-03311	1/4" (6.3 mm) x 1/4" (6.3 mm)	72	115	10	100

GB Flexible ratchet handle / round head
 D Flexible Drehkopfratsche
 PL Grzechotka z obrotową głowicą
 RUS Трещетка с вращательной головкой
 CZ Ráčna s otočnou hlavou
 H Forgófejes racsnis szár
 RO Antrenor cu clichet flexibil
 F Clé à cliquet tête pivotante
 I Cricchetto bussola reversibile con ghiera
 E Carraca con cabeza giratoria
 CN 旋轉頭快速脱落棘轮扳手

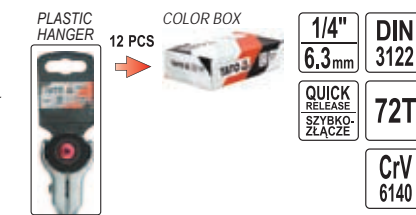

1/4" DIN 3122
 6.3mm
 QUICK RELEASE SZYBKO-ZŁĄCZE
 72T CrV 6140



YATO	Ø	T	L (mm)	PCS packing	
YT-0720	1/4" (6.3 mm)	72	145	12	24/96

GB Hexagonal socket
D Sechskantenschlüssel
PL Nasadka sześciokątna
RUS Головка шестигранная короткая
CZ Šestihřanný nástavec
H Hatszögű rátét
RO Cheie tubulară hexagonală
F Douille courte
I Chiave a bussola esagonale
E Boquilla hexagonal corta
CN 六角套筒

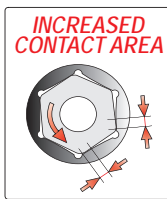
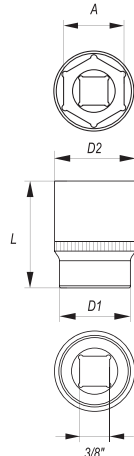

3/8"
10mm
DIN 3121
CrV 50BV30
AS-DRIVE

- drive locks
- surface finish: chromed, satin / mirror

- zamki blokujące
- wykończenie powierzchni: chromowana, satynowa / polerowana



YATO	∅ A (mm)	D1 (mm)	D2 (mm)	L (mm)	PCS packing	
YT-3801	6	10	17	28	24	240/480
YT-3802	7	11	17	28	24	240/480
YT-3803	8	12	17	28	24	240/480
YT-3804	9	13	17	28	24	240/480
YT-3805	10	14	17	28	24	240/480
YT-3806	11	16	17	28	24	240/480
YT-3807	12	18	17	28	24	240/480
YT-3808	13	19	18	28	24	240/480
YT-3809	14	20	19	28	24	240/480
YT-3810	15	21	19	28	24	240/480
YT-3811	16	22	21	28	24	240/480
YT-3812	17	24	22	30	12	120/240
YT-3813	18	25	23	30	12	120/240
YT-3814	19	26	24	30	12	120/240

GB Insulated hexagonal socket
D Sechskantenschlüssel vollisoliert
PL Nasadka sześciokątna izolowana
RUS Головка шестигранная короткая изолированная
CZ Šestihřanný nástavec, izolovaný
H Hatszögű rátét
RO Cheie tubulară hexagonală izolată
F Douille courte isolée
I Chiave a bussola esagonale isolato
E Boquilla hexagonal corta aislante
CN 绝缘六角套筒

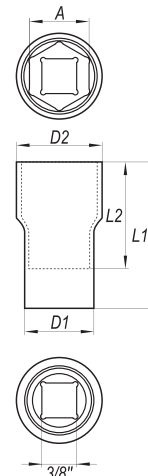

3/8"
10mm
CrV
1000 V
D/E

1000V
VDE CERTIFICATE
EN 60900:2012

YATO	∅ A (mm)	D1 (mm)	D2 (mm)	L1 (mm)	L2 (mm)	
YT-21008	8	18	15.1	45	28	7/126
YT-21010	10	18	18.7	45	28	7/126
YT-21011	11	18	20.0	45	28	7/126
YT-21012	12	18	21.2	45	28	7/126
YT-21013	13	18	22.5	45	28	7/126
YT-21014	14	18	23.7	45	28	7/126
YT-21016	16	18	26.2	45	28	7/126
YT-21017	17	18	27.5	45	28	7/126
YT-21018	18	18	28.7	45	30	5/90
YT-21019	19	18	30.0	47	30	5/90
YT-21021	21	18	32.6	47	30	5/90
YT-21022	22	18	33.7	47	30	5/90

GB Hexagonal deep socket
D Sechskantenschlüssel, lange
PL Nasadka sześciokątna długa
RUS Головка шестигранная длинная
CZ Šestihřanný hluboký nástavec
H Hatszögű rátét mély
RO Cheie tubulară hexagonală adâncă
F Douille longue
I Chiave a bussola esagonale
E Boquilla hexagonal larga
CN 六角长套筒

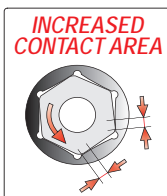
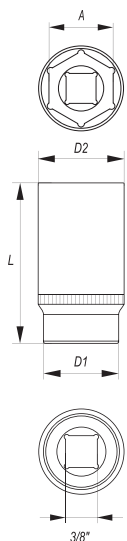

3/8"
10mm
DIN 3121
CrV 50BV30
AS-DRIVE

- drive locks
- surface finish: chromed, satin / mirror

- zamki blokujące
- wykończenie powierzchni: chromowana, satynowa / polerowana



YATO	∅ A (mm)	D1 (mm)	D2 (mm)	L (mm)	PCS packing	
YT-3820	6	10	17	63	24	48/96
YT-3821	7	10	17	63	24	48/96
YT-3822	8	12	17	63	24	48/96
YT-3823	9	13	17	63	24	48/96
YT-3824	10	14	17	63	24	48/96
YT-3825	11	16	17	63	24	48/96
YT-3826	12	18	17	63	24	48/96
YT-3827	13	19	17	63	24	48/96
YT-3828	14	20	19	63	24	48/96
YT-3829	15	21	19	63	12	60/120
YT-3830	16	22	20	63	12	60/120
YT-3831	17	24	23	63	12	60/120
YT-3832	18	25	23	63	12	60/120
YT-3833	19	26	24	63	12	60/120

GB Extension bar
D Verlängerung
PL Przedłużka
RUS Удлинитель для воротка
CZ Prodlužovací přípravek
H Toldalék
RO Prelungitor
F Rallonge
I Prolunga
E Tubo de prolongación
CN 接杆

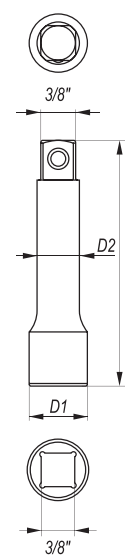

3/8"
10mm
DIN 3121
CrV 50BV30

COLOR BOX



YATO	∅	D1 (mm)	D2 (mm)	L (mm)	PCS packing	
YT-3842	3/8" (9.5 mm)	18.0	12.3	42.0	10	100/200
YT-3843	3/8" (9.5 mm)	18.0	12.3	76.0	10	100/200
YT-3844	3/8" (9.5 mm)	18.0	12.3	152.4	10	50/100
YT-3845	3/8" (9.5 mm)	18.0	12.3	254.0	10	50

- GB Insulated extension bar
- D Verlängerung vollisoliert
- PL Przedłużka izolowana
- RUS Удлинитель для воротка
- CZ Prodlužovací přípravek, izolovaný
- H Toldalék
- RO Prelungitor izolat
- F Rallonge isolée
- I Prolunga isolato
- E Tubo de prolongación aislante
- CN 绝缘接杆

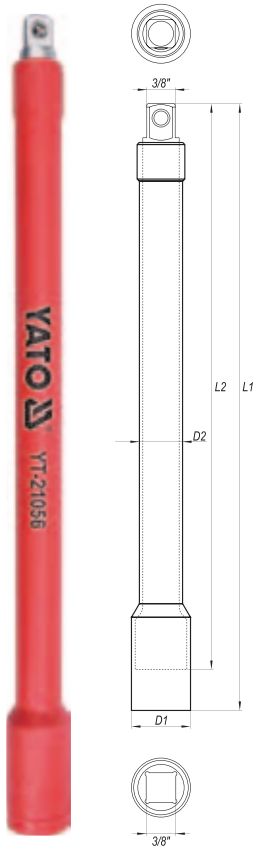

3/8"
10mm
CrV
1000 V
DVE

1000V
VDE CERTIFICATE
EN 60900:2012

YATO	Ø	D1 (mm)	D2 (mm)	L1 (mm)	L2 (mm)	PCS packing
YT-21055	3/8" (9.5 mm)	23	15.5	125	141	18/72
YT-21056	3/8" (9.5 mm)	23	15.5	250	266	12/48

- GB Extension bar with wobble
- D Gelenkverlängerung
- PL Przedłużka uchylna
- RUS Удлинитель наклонный
- CZ Odchylný prodlužovací přípravek
- H Csuklós toldalék
- RO Prelungitor rabatabil
- F Rallonge angulaire
- I Prolunga
- E Tubo de prolongación desviable
- CN 转向接杆

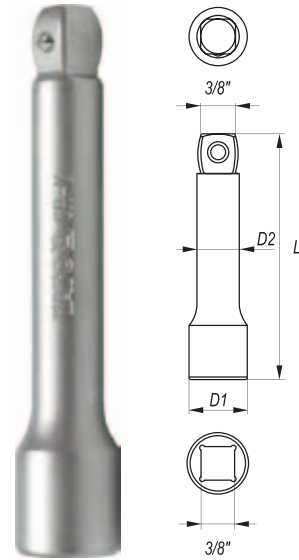

3/8"
10mm
DIN 3121
CrV 50BV30

COLOR BOX



YATO	Ø	D1 (mm)	D2 (mm)	L (mm)	PCS packing
YT-3847	3/8" (9.5 mm)	18.0	12.3	76.0	10 100/200
YT-3848	3/8" (9.5 mm)	18.0	12.3	152.4	10 50/100
YT-3849	3/8" (9.5 mm)	18.0	12.3	254.0	10 50

- GB Adapter
- D Reduktion
- PL Redukcja
- RUS Переходник
- CZ Redukce
- H Redukció
- RO Reducție
- F Réduction
- I Riduttore
- E Reducción
- CN 转换头

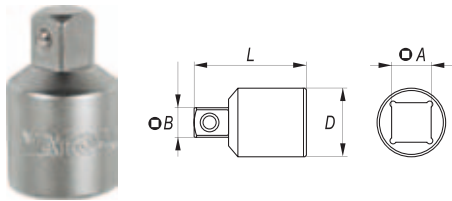

3/8"
10mm
DIN 3121
CrV 50BV30

COLOR BOX



YATO	Ø A	Ø B	D (mm)	L (mm)	PCS packing
YT-3853	3/8" (9.5 mm) (F)	1/4" (6.3 mm) (M)	17	27	10 250/500
YT-3854	3/8" (9.5 mm) (F)	1/2" (12.7 mm) (M)	17	35	10 100/200

- GB Bit adapter
- D Bithalter
- PL Adapter do bitów
- RUS Держатель винтовёртовых наконечников
- CZ Držák na šroubovavkové koncovky
- H Szár a csavarhúzóvégekhez
- RO Capete şurubelniță
- F Adaptateur d'embouts
- E Mandril para puntas
- CN 旋具头接头

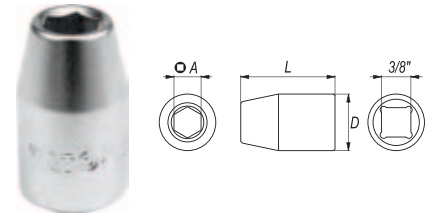

3/8"
10mm
CrV 6140

COLOR BOX



YATO	Ø	Ø A	D (mm)	L (mm)	PCS packing
YT-1296	3/8" (9.5 mm)	8 mm	17.9	30	10 250/500

- GB Universal joint
- D Kardangelen
- PL Przegub Cardana
- RUS Карданный шарнир
- CZ Kardanový kloub
- H Kardán csukló
- RO Articulație Cardanică
- F Cardan
- I Snodo cardanico
- E Articulación Cardan
- CN 万向接头

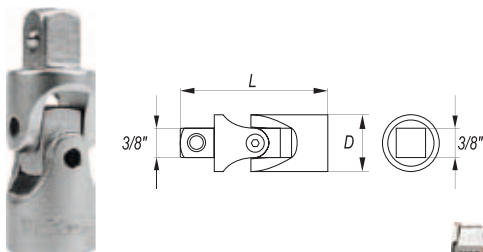

3/8"
10mm
DIN 3121
CrV 50BV30

COLOR BOX



YATO	Ø	D (mm)	L (mm)	PCS packing
YT-3850	3/8" (9.5 mm)	18	49	10 50/200

- GB Sliding T-bar
- D Handgriff mit Gleitstück
- PL Pokrętło typu „T”
- RUS Вороток Т-образный
- CZ Otočná račka typ „T”
- H „T” alakú hajtókar
- RO Mâner clupă tipul „T”
- F Barre type „T”
- I Manopola „T” scorrevole
- E Mango tipo „T”
- CN 滑行杆

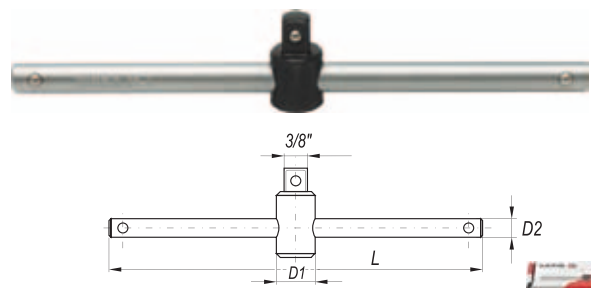

3/8"
10mm
DIN 3121
CrV 50BV30

COLOR BOX



YATO	Ø	D1 (mm)	D2 (mm)	L (mm)	PCS packing
YT-3840	3/8" (9.5 mm)	20.0	10.7	198	10 50/100

GB Flexible handle
D Gelengriff
PL Pokręto łamane
RUS Вороток шарнирный

CZ Otočná lomená ráčka
H Hajlított hajtókar
RO Prelungitor cu prindere flexibilă

F Barre pivotante
I Manopola a snodo
E Mango articulado
CN 转向手柄

3/8"
10mm
DIN 3121
CrV
50BV30

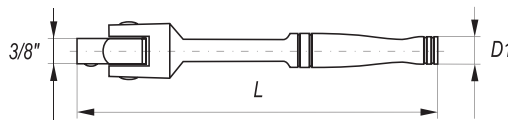

COLOR BOX

YATO	Ø	D (mm)	L (mm)	PCS packing:	
YT-3839	3/8" (9.5 mm)	16	215	8	24/48

GB Spark plug socket
D Steckschlüssel mit Gummihalterung
PL Nasadka do świec
RUS Головка свечная
CZ Nastavec pro svíčky

H Gyújtógyertya toldalék
RO Cheie de bujii
F Douille à bougies
I Chiavi a bussola
E Boquilla de bujias
CN 六角火花塞套筒



3/8"
10mm
DIN 3121
AS-DRIVE
CrV
50BV30

GB Spark plug socket
D Steckschlüssel mit Gummihalterung
PL Nasadka do świec
RUS Головка свечная
CZ Nastavec pro svíčky

H Gyújtógyertya toldalék
RO Cheie de bujii
F Douille à bougies
I Chiavi a bussola
E Boquilla de bujias
CN 六角火花塞套筒



3/8"
10mm
DIN 3124
AS-DRIVE
CrV
6140

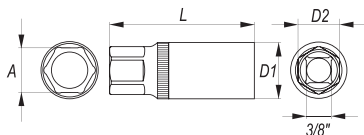

COLOR BOX

YATO	Ø	A	D1 (mm)	D2 (mm)	L (mm)	PCS packing:	
YT-3851	3/8" (9.5 mm)	16.0	22.0	19.0	64.0	10	50/100

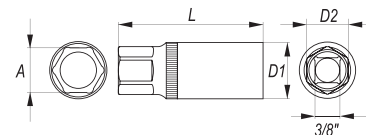

COLOR BOX

YATO	Ø	A	D1 (mm)	D2 (mm)	L (mm)	PCS packing:	
YT-3841	3/8" (9.5 mm)	18.0	25.8	19.0	63	25	50/100

GB Quick release ratchet handle
D Hebelumschaltknarre
PL Grzechotka
RUS Трещотка
CZ Řehtačka
H Racsnis hajtókar

RO Dispozitiv de prindere cu clichet
F Clé à cliquet
I Cricchetto bussola
E Carraca
CN 快速脱落棘轮扳手

PLASTIC HANGER



6 PCS



COLOR BOX

3/8"
10mm
DIN 3122
QUICK RELEASE SZYBKO-ZŁĄCZE
72T
CrV
6140



YATO	Ø	T	L (mm)	PCS packing:	
YT-0308	3/8" (9.5 mm)	72	185	6	24/48

YATO	Ø	T	L (mm)	PCS packing:	
YT-0311	3/8" (9.5 mm)	72	200	6	18/36

YATO	Ø	T	L (mm)	PCS packing:	
YT-0314	3/8" (9.5 mm)	72	170	6	24/48



YATO	Ø	T	L (mm)	PCS packing:	
YT-0317	3/8" (9.5 mm)	72	200	6	24/48

YATO	Ø	T	L (mm)	PCS packing:	
YT-0320	3/8" (9.5 mm)	72	205	6	24/48

YATO	Ø	T	L (mm)	PCS packing:	
YT-0323	3/8" (9.5 mm)	72	197	6	24/48

GB Quick release ratchet handle
 D Hebelumschaltknarre
 PL Grzechotka
 RUS Трещотка
 CZ Řehtačka
 H Racsnis hajtókar

RO Dispozitiv de prindere cu clichet
 F Clé à cliquet
 I Cricchetto bussola
 E Carraca
 CN 快速脱落棘轮扳手

PLASTIC HANGER



6 PCS



COLOR BOX

3/8"
10mm

QUICK RELEASE SZYBKO-ZŁĄCZE

DIN 3122

72T

CrV 6140

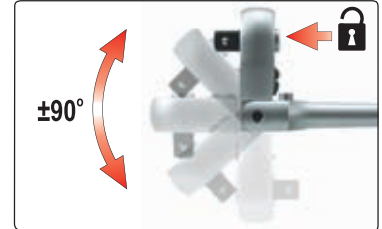

YATO	Ø	T	L (mm)	PCS packing	Box
YT-0326	3/8" (9.5 mm)	72	242	6	24/48

GB Quick release ratchet handle
 D Hebelumschaltknarre
 PL Grzechotka powlekana
 RUS Трещотка
 CZ Řehtačka
 H Racsnis hajtókar

RO Dispozitiv de prindere cu clichet
 F Clé à cliquet
 I Cricchetto bussola
 E Carraca
 CN 快速脱落棘轮扳手

PLASTIC HANGER



6 PCS



COLOR BOX

3/8"
10mm

DIN 3122

QUICK RELEASE SZYBKO-ZŁĄCZE

72T

CrV 6135



YATO	Ø	T	L (mm)	PCS packing	Box
YT-0291	3/8" (9.5 mm)	72	202	6	24/48

YATO	Ø	T	L (mm)	PCS packing	Box
YT-0294	3/8" (9.5 mm)	72	202	6	24/48

GB Insulated ratchet handle
 D Hebelumschaltknarre vollisoliert
 PL Grzechotka izolowana
 RUS Трещотка диэлектрическая
 CZ Řehtačka, izolovaná
 H Racsnis hajtókar
 RO Antrenor cu clichet izolat
 F Clé à cliquet isolée
 I Cricchetto bussola isolato
 E Carraca aislante
 CN 绝缘棘轮扳手

3/8"
10mm

CrV

1000 V



1000V
 VDE CERTIFICATE
 EN 60900:2012

YATO	Ø	T	L (mm)	Box
YT-21071	3/8" (9.5 mm)	36	200	6/48

GB Quick release ratchet handle
D Hebelumschaltknarre
PL Grzechotka
RUS Трещотка
CZ Řehtačka
H Racsnis hajtókar
RO Dispozitiv de prindere cu clichet
F Clé à cliquet
I Cricchetto bussola
E Carraca
CN 快速脱落棘轮扳手



6 PCS



3/8"
10mm
72T

QUICK
RELEASE
SZYBKO-
ZŁĄCZE
CrV
6140



GB Quick release ratchet handle
D Hebelumschaltknarre
PL Grzechotka
RUS Трещотка
CZ Řehtačka
H Racsnis hajtókar
RO Dispozitiv de prindere cu clichet
F Clé à cliquet
I Cricchetto bussola
E Carraca
CN 快速脱落棘轮扳手





6 PCS





3/8"
10mm
72T

QUICK
RELEASE
SZYBKO-
ZŁĄCZE
CrV
6135



YATO 	Ø	T	L (mm)	PCS packing:	
YT-0731	3/8" (9.5 mm)	72	200	6	24/48

YATO 	Ø	T	L (mm)	PCS packing:	
YT-0734	3/8" (9.5 mm)	72	200	6	24/48

GB Telescopic ratchet handle
D Umschaltknarre
PL Grzechotka z przedłużanym uchwytem
RUS Трещотка
CZ Řehtačka
H Racsnis hajtókar
RO Antrenor cu clichet
F Clé à cliquet
I Cricchetto bussola
E Carraca telescópico
CN 可伸缩快速脱落棘轮扳手

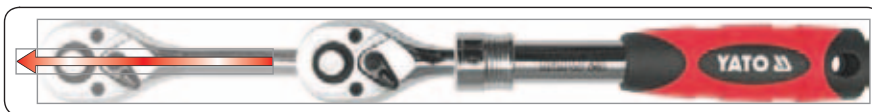

3/8"
10mm
72T

QUICK
RELEASE
SZYBKO-
ZŁĄCZE
CrV
6135





PLASTIC
HANGER



6 PCS

COLOR BOX



YATO 	Ø	T	L (mm)	PCS packing:	
YT-0298	3/8" (9.5 mm)	72	215-315	6	24

- GB Hexagonal socket
- D Sechskantenschlüssel
- PL Nasadka sześciokątna
- RUS Головка шестигранная короткая
- CZ Šestihránný nástavec
- H Hatszögű rátét
- RO Cheie tubulară hexagonală
- F Douille courte
- I Chiave a bussola esagonale
- E Boquilla hexagonal corta
- CN 六角套筒

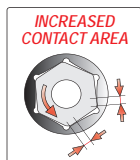

1/2" 12.5mm
DIN 3121
CrV 50BV30 AS-DRIVE

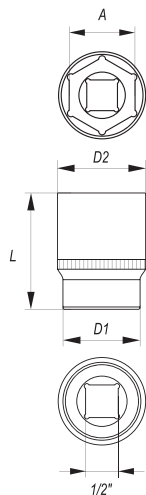

- drive locks
- surface finish: chromed, satin / mirror
- zamki blokujące
- wykończenie powierzchni: chromowana, satynowa / polerowana

YATO	∅ A (mm)	D1 (mm)	D2 (mm)	L (mm)	PCS packing	
YT-1201	8	12	22	38	12	120/240
YT-1202	9	14	22	38	12	120/240
YT-1203	10	15	22	38	12	120/240
YT-1204	11	16	22	38	12	120/240
YT-1205	12	18	22	38	12	120/240
YT-1206	13	19	22	38	12	120/240
YT-1207	14	20	22	38	12	120/240
YT-1208	15	21	22	38	10	100/200
YT-1209	16	23	22	38	12	120/240
YT-1210	17	24	23	38	12	120/240
YT-1211	18	25	23	38	12	120/240
YT-1212	19	27	24	38	12	120/240
YT-1213	20	28	24	38	12	120/240
YT-1214	21	29	24	38	12	120/240
YT-1215	22	30	26	38	12	120/240
YT-1216	23	31	28	38	12	60/120
YT-1217	24	32	28	38	12	60/120
YT-1218	27	36	30	42	12	60/120
YT-1219	30	40	34	42	10	50/100
YT-1220	32	42	36	42	10	50/100

- GB Insulated hexagonal socket
- D Sechskantenschlüssel vollisoliert
- PL Nasadka sześciokątna izolowana
- RUS Головка шестигранная короткая изолированная
- CZ Šestihránný nástavec, izolovaný
- H Hatszögű rátét
- RO Cheie tubulară hexagonală izolată
- F Douille courte isolée
- I Chiave a bussola esagonale isolato
- E Boquilla hexagonal corta aislante
- CN 绝缘六角套筒

1/2" 12.5mm CrV
1000V DVE

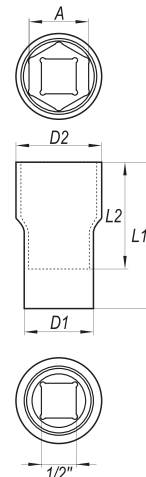

1000V VDE CERTIFICATE EN 60900:2012

YATO	∅ A (mm)	D1 (mm)	D2 (mm)	L1 (mm)	L2 (mm)	
YT-21030	10	27	19.5	55	38	12/144
YT-21031	11	27	20.7	55	38	12/144
YT-21032	12	27	22.0	55	38	12/144
YT-21033	13	27	23.2	55	38	12/144
YT-21034	14	27	24.5	55	38	12/144
YT-21036	16	27	27.0	55	38	12/144
YT-21037	17	27	28.5	55	38	12/144
YT-21038	18	27	29.5	55	38	12/144
YT-21039	19	27	30.7	55	38	12/144
YT-21041	21	27	33.2	55	38	10/110
YT-21042	22	27	34.5	55	38	10/110
YT-21044	24	27	37.0	60	38	10/110
YT-21047	27	27	38.8	60	38	6/66
YT-21050	30	27	42.8	60	38	6/66
YT-21052	32	27	44.8	60	38	6/66

- GB Bi-hexagonal socket
- D Zwölfkant-Steckschlüssel-Einsatz
- PL Nasadka dwunastokątna
- RUS Головка 12-гранная
- CZ Nástrčný ořech dvanáctihránný
- H Dugófej, 12 lapú
- RO Cheie tubulară bihexagonală
- F Douille courte
- I Chiave a bussola esagonale
- E Boquilla de anillo
- CN 十二角套筒

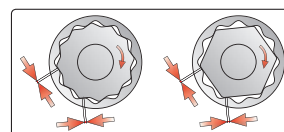

1/2" 12.5mm DIN 3121 CrV 50BV30 AS-DRIVE

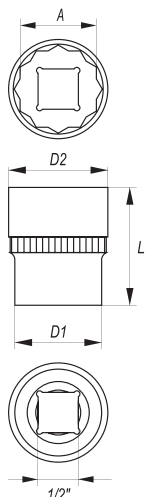

- drive locks
- surface finish: chromed, satin / mirror
- zamki blokujące
- wykończenie powierzchni: chromowana, satynowa / polerowana

YATO	∅ A (mm)	D1 (mm)	D2 (mm)	L (mm)	PCS packing	
YT-1270	8	12	22	38	12	120/240
YT-1271	9	14	22	38	12	120/240
YT-1272	10	15	22	38	12	120/240
YT-1273	11	16	22	38	12	120/240
YT-1274	12	17	22	38	12	120/240
YT-1275	13	19	22	38	12	120/240
YT-1276	14	20	22	38	12	120/240
YT-1277	15	21	22	38	10	100/200
YT-1278	16	23	22	38	12	120/240
YT-1279	17	24	22	38	12	120/240
YT-1280	18	25	23	38	12	120/240
YT-1281	19	27	24	38	12	120/240
YT-1282	20	28	24	38	12	120/240
YT-1283	21	29	24	38	12	120/240
YT-1284	22	30	26	38	12	120/240
YT-1285	23	31	28	38	12	60/120
YT-1286	24	32	28	38	12	60/120
YT-1289	27	36	30	42	12	60/120
YT-1291	30	40	34	42	10	50/100
YT-1292	32	42	36	42	10	50/100

- GB Spline socket
D Steckschlüssel Spline
PL Nasadka Spline
RUS Головка Spline
CZ Nástrčný klíč profil Spline
H Spline dugófej
- RO Cheie tubulară cu stifturi
F Douille
I Chiave a bussola spline
E Boquilla Spline
CN 花键型套筒

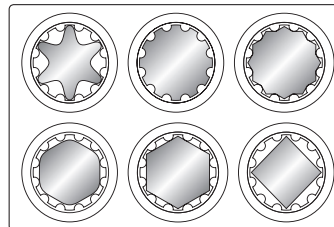

1/2"
12.5mm

DIN
3121

CrV
50BV30

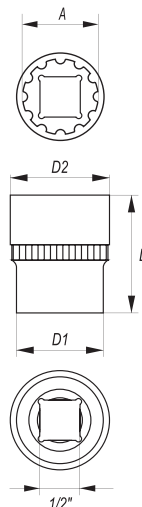

COLOR BOX



YATO	∅ A (mm)	D1 (mm)	D2 (mm)	L (mm)	PCS packing	
YT-1460	8	13	22	38	10	100/200
YT-1461	9	15	22	38	10	100/200
YT-1462	10	16	22	38	10	100/200
YT-1463	11	17	22	38	10	100/200
YT-1464	12	18	22	38	10	100/200
YT-1465	13	19	22	38	10	100/200
YT-1466	14	20	22	38	10	100/200
YT-1467	15	22	23	38	10	100/200
YT-1468	16	23	22	38	10	100/200
YT-1469	17	25	23	38	10	100/200
YT-1470	18	26	23	38	10	100/200
YT-1471	19	27	24	38	10	100/200
YT-1472	20	28	24	38	10	100/200
YT-1473	21	30	24	38	10	100/200
YT-1474	22	31	26	38	10	100/200
YT-1475	23	32	28	38	10	50/100
YT-1476	24	34	28	38	10	50/100
YT-1478	27	37	30	42	10	50/100
YT-1480	30	41	34	42	10	50/100
YT-1481	32	44	36	45	10	50/100

- drive locks
- enables to undo 5 types of screws
- allows to unscrew nuts damaged in 70%
- surface finish: chromed, satin / mirror
- zamki blokujące
- możliwość odkręcenia 5 rodzajów śrub
- możliwość odkręcenia nasadek zniszczonych w 70%
- wykończenie powierzchni: chromowana, satynowa / polerowana

- GB Hexagonal deep socket
D Sechskantenschlüssel, lange
PL Nasadka sześciokątna długa
RUS Головка шестигранная длинная
CZ Šestihranný hluboký nástavec
- H Hatszögű rátét mély
RO Cheie tubulară hexagonală adâncă
F Douille longue
I Chiave a bussola esagonale
E Boquilla hexagonal larga
CN 六角长套筒

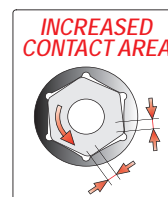

1/2"
12.5mm

DIN
3121

CrV
50BV30

AS-DRIVE

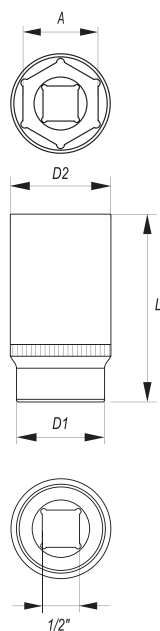

COLOR BOX



YATO	∅ A (mm)	D1 (mm)	D2 (mm)	L (mm)	PCS packing	
YT-1221	8	13	22	76	12	60/120
YT-1222	9	14	22	76	12	60/120
YT-1223	10	15	22	76	12	60/120
YT-1224	11	17	22	76	12	60/120
YT-1225	12	18	22	76	12	60/120
YT-1226	13	19	22	76	12	60/120
YT-1227	14	20	22	76	12	60/120
YT-1228	15	21	22	76	12	60/120
YT-1229	16	24	22	76	12	60/120
YT-1230	17	24	22	76	12	60/120
YT-1231	18	25	23	76	12	60/120
YT-1232	19	27	24	76	12	60/120
YT-1233	20	28	24	76	12	60/120
YT-1234	21	29	24	76	12	60/120
YT-1235	22	30	26	76	12	60/120
YT-1236	23	31	28	76	12	60/120
YT-1237	24	32	28	76	12	60/120
YT-1238	27	36	30	76	10	50
YT-1239	30	40	36	76	10	20/40
YT-1240	32	42	38	76	10	20/40

- drive locks
- surface finish: chromed, satin / mirror
- zamki blokujące
- wykończenie powierzchni: chromowana, satynowa / polerowana

- GB Extension bar
- D Verlängerung
- PL Przedłużka
- RUS Удлинитель для воротка
- CZ Prodlužovací přípravek
- H Toldalék
- RO Prelungitor
- F Rallonge
- I Prolunga
- E Tubo de prolongación
- CN 接杆

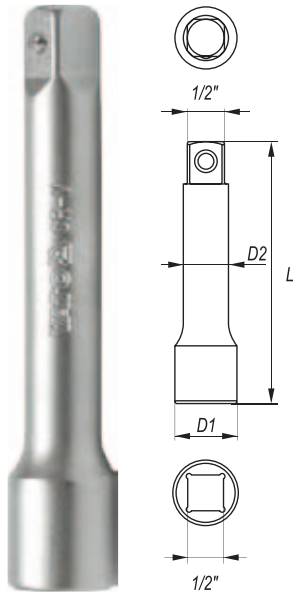

- 1/2"
- 12.5mm
- DIN 3121
- CrV 50BV30

COLOR BOX



YATO	Ø	D1 (mm)	D2 (mm)	L (mm)	PCS packing:	
YT-1246	1/2" (12.7 mm)	24.0	14.5	76	10	30/120
YT-1247	1/2" (12.7 mm)	24.0	14.5	127	5	20/80
YT-1248	1/2" (12.7 mm)	24.0	14.5	254	5	20/40

- GB Extension bar with wobble
- D Gelenkverlängerung
- PL Przedłużka uchylna
- RUS Удлинитель наклонный
- CZ Odchylný prodlužovací přípravek
- H Csuklós toldalék
- RO Prelungitor rabatabil
- F Rallonge angulaire
- I Prolunga
- E Tubo de prolongación desviable
- CN 转向接杆

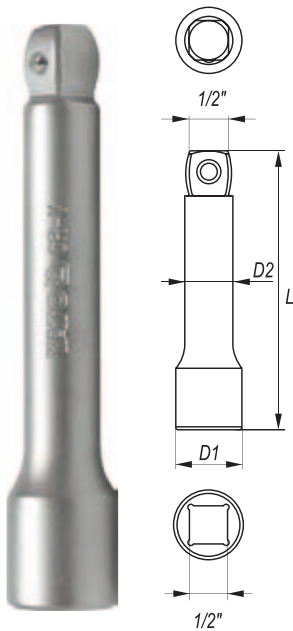

- 1/2"
- 12.5mm
- DIN 3121
- CrV 50BV30

COLOR BOX



YATO	Ø	D1 (mm)	D2 (mm)	L (mm)	PCS packing:	
YT-1249	1/2" (12.7 mm)	24.0	14.5	76	15	30/120
YT-1250	1/2" (12.7 mm)	24.0	14.5	127	5	20/80
YT-1251	1/2" (12.7 mm)	24.0	14.5	254	5	20/40

- GB Insulated extension bar
- D Verlängerung vollisoliert
- PL Przedłużka izolowana
- RUS Удлинитель для воротка для воротка
- CZ Prodlužovací přípravek, izolovaný
- H Toldalék
- RO Prelungitor izolat
- F Rallonge isolée
- I Prolunga isolato
- E Tubo de prolongación aislante
- CN 绝缘接杆

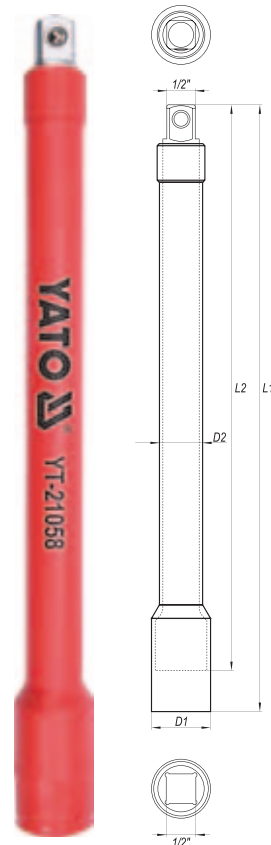

- 1/2"
- 12.5mm
- CrV
- 1000 V
- D'E

1000V
VDE CERTIFICATE
EN 60900:2012

YATO	Ø	D1 (mm)	D2 (mm)	L1 (mm)	L2 (mm)	
YT-21057	1/2" (12.7 mm)	27	19.1	125	141	6/72
YT-21058	1/2" (12.7 mm)	27	19.1	250	266	8/32

- GB Adapter
- D Reduktion
- PL Redukcja
- RUS Переходник
- CZ Redukce
- H Redukció
- RO Reducție
- F Réduction
- I Riduttore
- E Reducción
- CN 转换头

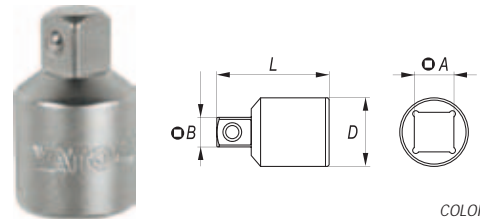

- 1/2"
- 12.5mm
- 3/4"
- 19mm
- DIN 3121
- CrV 50BV30

COLOR BOX



YATO	Ø A	Ø B	D (mm)	L (mm)	PCS packing:	
YT-1255	1/2" (12.7 mm) (F)	3/8" (9.5 mm) (M)	22	34.0	10	100/200
YT-1258	1/2" (12.7 mm) (F)	3/4" (19.0 mm) (M)	27	45.5	10	50/100
YT-1259	3/4" (19.0 mm) (F)	1/2" (12.7 mm) (M)	35	51.0	5	50/100
YT-1356	1/2" (12.7 mm) (F)	3/4" (19.0 mm) (M)	26	48.0	12	48

- GB Bit adapter
- D Bithalter
- PL Adapter do bitów
- RUS Держатель винтовёртовых наконечников
- CZ Držák na šroubovakové koncovky
- H Szár a csavarhúzóvégekhez
- RO Capete şurubelniță
- F Adaptateur d'embouts
- I Chiave esagonale a bussola
- E Mandril para puntas
- CN 旋具头接头

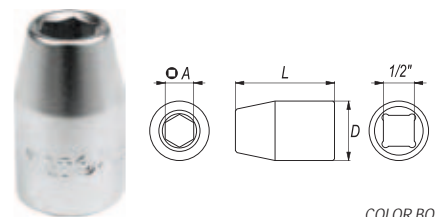

- 1/2"
- 12.5mm
- CrV 6140

COLOR BOX



YATO	Ø	Ø A	D (mm)	L (mm)	PCS packing:	
YT-1295	1/2" (12.7 mm)	8 mm	21.9	38	10	250/500

- GB Universal joint
D Kardangelen
PL Przegub Cardana
RUS Карданный шарнир
CZ Kardanový kloub
H Kardán csukló
- RO Articulație Cardanică
F Cardan
I Snodo cardanico
E Articulación Cardan
CN 万向接头

1/2"
12.5mm

DIN
3121

CrV
50BV30

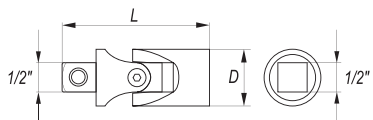

COLOR BOX



YATO	Ø	D (mm)	L (mm)	PCS packing	
YT-1252	1/2" (12.7 mm)	25	69	5	50/100

- GB Sliding T-bar
D Handgriff
mit Gleitstück
PL Pokręto typu „T”
RUS Вороток Т-образный
- CZ Otočná ráčká typ „T”
H „T” alakú hajtókar
RO Mâner clupă tipul „T”
F Barre type „T”
- I Manopola „T”
E scorrevole
Mango tipo „T”
CN 滑行杆

1/2"
12.5mm

DIN
3121

CrV
50BV30

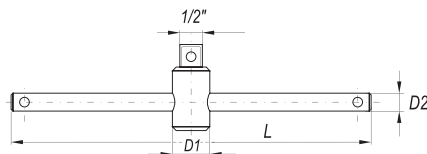

COLOR BOX



YATO	Ø	D1 (mm)	D2 (mm)	L (mm)	PCS packing	
YT-1243	1/2" (12.7 mm)	24.0	13.5	255	4	24/48

- GB Flexible handle
D Gelengriff
PL Pokręto łamane
RUS Вороток шарнирный
CZ Otočná ložená ráčka
H Hajlított hajtókar
RO Prelungitor
cu prindere flexibilă
F Barre pivotante
I Manopola a snodo
E Mango articulado
CN 转向手柄

1/2"
12.5mm

DIN
3121

CrV
50BV30

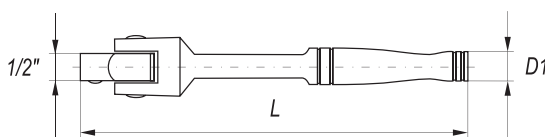

COLOR BOX



YATO	Ø	D (mm)	L (mm)	PCS packing	
YT-1241	1/2" (12.7 mm)	19	360	5	15/30
YT-1242	1/2" (12.7 mm)	20	457	5	10/20

- GB L-type handle
D Admutterenschlüssel
PL Pokręto typu „L”
RUS Вороток 1/2" тип „L”
CZ Páka zahnutá
H „L” alakú hajtókar
RO Mâner clupă tipul „L”
F Barre type „L”
I Leva tipo „L”
E Mango tipo „L”
CN L型套筒扳手

1/2"
12.5mm

DIN
3121

CrV
50BV30



COLOR BOX



YATO	Ø	D (mm)	L (mm)	PCS packing	
YT-1244	1/2" (12.7 mm)	16.5	317	3	36

- GB Spark plug socket
D Steckschlüssel
mit Gummihalterung
PL Nasadka do świec
RUS Головка свечная
CZ Nastavec pro svíčky
H Gyújtógyertya toldalék
RO Cheie de bujii
F Douille à bougies
I Chiavi a bussola
E Boquilla de bujías
CN 六角火花塞套筒

 1/2"
12.5mm

DIN
3121

CrV
50BV30

AS-DRIVE

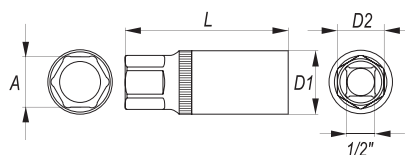

COLOR BOX



YATO	Ø	A	D1 (mm)	D2 (mm)	L (mm)	PCS packing	
YT-1253	1/2" (12.7 mm)	16.0	22.0	19.0	64.0	10	50/100
YT-1254	1/2" (12.7 mm)	21.0	27.8	24.0	64.0	10	50/100

GB Quick release ratchet handle
 D Hebelumschaltknarre
 PL Grzechotka
 RUS Трещотка
 CZ Řehtačka
 H Racsnis hajtókar

RO Dispozitiv de prindere cu clichet
 F Clé à cliquet
 I Cricchetto bussola
 E Carraca
 CN 快速脱落棘轮扳手

PLASTIC HANGER



6 PCS



COLOR BOX

1/2"
12.5mm

DIN
3122

QUICK
RELEASE
SZYBKO-
ZŁĄCZE

72T

CrV
6140



YATO	Ø	T	L (mm)	PCS packing	Box
YT-0309	1/2" (12.7 mm)	72	278	6	24

YATO	Ø	T	L (mm)	PCS packing	Box
YT-0312	1/2" (12.7 mm)	72	250	6	12/24

YATO	Ø	T	L (mm)	PCS packing	Box
YT-0315	1/2" (12.7 mm)	72	250	6	24



YATO	Ø	T	L (mm)	PCS packing	Box
YT-0318	1/2" (12.7 mm)	72	250	6	24

YATO	Ø	T	L (mm)	PCS packing	Box
YT-0321	1/2" (12.7 mm)	72	255	6	24

YATO	Ø	T	L (mm)	PCS packing	Box
YT-0324	1/2" (12.7 mm)	72	265	6	24

GB Quick release ratchet handle
 D Hebelumschaltknarre
 PL Grzechotka
 RUS Трещотка

CZ Řehtačka
 H Racsnis hajtókar
 RO Dispozitiv de prindere cu clichet
 F Clé à cliquet
 I Cricchetto bussola
 E Carraca
 CN 快速脱落棘轮扳手

PLASTIC HANGER



6 PCS



COLOR BOX

1/2"
12.5mm

QUICK
RELEASE
SZYBKO-
ZŁĄCZE

DIN
3122

72T

CrV
6140

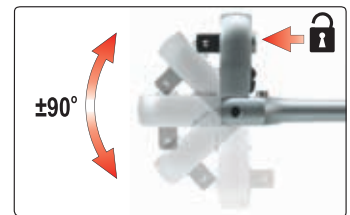

YATO	Ø	T	L (mm)	PCS packing	Box
YT-0327	1/2" (12.7 mm)	72	290	6	24

GB Quick release ratchet handle
 D Hebelumschaltknarre
 PL Grzechotka powlekana
 RUS Трещотка
 CZ Řehtačka
 H Racsnis hajtókar

RO Dispozitiv de prindere cu clichet
 F Clé à cliquet
 I Cricchetto bussola
 E Carraca
 CN 快速脱落棘轮扳手

PLASTIC HANGER



6 PCS



1/2"
12.5mm

DIN
3122

QUICK
RELEASE
SZYBKO-
ZŁĄCZE

72T

CrV
6135



YATO	Ø	T	L (mm)	PCS packing	Box
YT-0292	1/2" (12.7 mm)	72	257	6	24

YATO	Ø	T	L (mm)	PCS packing	Box
YT-0295	1/2" (12.7 mm)	72	257	6	24

GB Insulated ratchet handle
 D Hebelumschaltknarre vollisoliert
 PL Grzechotka izolowana
 RUS Трещотка диэлектрическая
 CZ Řehtačka, izolovaná
 H Racsnis hajtókar
 RO Antrenor cu clichet izolat
 F Clé à cliquet isolée
 I Cricchetto bussola isolato
 E Carraca aislante
 CN 绝缘棘轮扳手



1/2"
12.5mm

CrV

1000
V



1000V
VDE CERTIFICATE
EN 60900:2012

YATO	Ø	T	L (mm)	Box
YT-21072	1/2" (12.7 mm)	36	250	6/36

- GB Quick release ratchet handle
D Hebelumschaltknarre
PL Grzechotka
RUS Трещотка
CZ Řehtačka
H Racsnis hajtókar
RO Dispozitiv de prindere cu clichet
F Clé à cliquet
I Cricchetto bussola
E Carraca
CN 快速脱落棘轮扳手

PLASTIC HANGER
6 PCS
COLOR BOX
1/2" QUICK RELEASE SZYBKO-ZŁĄCZE 12.5mm
72T CrV 6140



YATO	Ø	T	L (mm)	PCS packing	
YT-0732	1/2" (12.7 mm)	72	255	6	24

- GB Quick release ratchet handle
D Hebelumschaltknarre
PL Grzechotka
RUS Трещотка
CZ Řehtačka
H Racsnis hajtókar
RO Dispozitiv de prindere cu clichet
F Clé à cliquet
I Cricchetto bussola
E Carraca
CN 快速脱落棘轮扳手

PLASTIC HANGER
6 PCS
COLOR BOX
1/2" QUICK RELEASE SZYBKO-ZŁĄCZE 12.5mm
72T CrV 6135



YATO	Ø	T	L (mm)	PCS packing	
YT-0735	1/2" (12.7 mm)	72	255	6	24

- GB Telescopic ratchet handle
D Umschaltknarre
PL Grzechotka z przedłużanym uchwytem
RUS Трещотка
CZ Řehtačka
H Racsnis hajtókar
RO Antrenor cu clichet
F Clé à cliquet
I Cricchetto bussola
E Carraca telescópico
CN 可伸缩快速脱落棘轮扳手



1/2" QUICK RELEASE SZYBKO-ZŁĄCZE 12.5mm
72T CrV 6135



PLASTIC HANGER
6 PCS
COLOR BOX

YATO	Ø	T	L (mm)	PCS packing	
YT-0299	1/2" (12.7 mm)	72	305-445	6	24

- GB Flexible ratchet handle / round head
D Flexible Drehkopfratsche
PL Grzechotka z obrotową głowicą
RUS Трещетка с вращательной головкой
CZ Ráčna s otočnou hlavou
H Forgófejes racsnis szár
RO Antrenor cu clichet flexibil
F Clé à cliquet tête pivotante
I Cricchetto bussola reversibile con ghiera
E Carraca con cabeza giratoria
CN 旋转头快速脱落棘轮扳手



1/2" QUICK RELEASE SZYBKO-ZŁĄCZE 12.5mm
72T CrV 6140
PLASTIC HANGER
6 PCS
COLOR BOX

YATO	Ø	T	L (mm)	PCS packing	
YT-0722	1/2" (12.7 mm)	72	280	6	30

- GB Internal ratchet wrench
D Innenratschenschlüssel
PL Grzechotka wewnętrzna
RUS Трещотка внутренняя
CZ Radiátorový kluč s ráčnou
H Lépcsős kulcskészlet racsníval

RO Cheie robinet radiator
F Clé de montage étagée
I Cricchetto di tipo interno
E Llave carraca radiadores
CN 穿心棘轮扳手
1/2" QUICK RELEASE SZYBKO-ZŁĄCZE 12.5mm
CrV 30T



for / dla: YT-03316

TIED ON CARD

YATO	Ø	
YT-03315	1/2" (12.7 mm)	6/24

- GB Step wrench
D Stufenschlüssel
PL Klucz stopniowy
RUS Калибратор FORA для металлопластиковых труб
CZ Klíč na radiátorové šroubení
H Lépcsős radiátor kulcs
RO Cheie in trepte pt. radiator
F Clé de montage étagée
I Chiave a cricco
E Llave de radiadores
CN 散熱六角階梯扳手

1/2" QUICK RELEASE SZYBKO-ZŁĄCZE 12.5mm
3/8" 29/68" 1/2" 21/32" 27/32" 9.6 mm 11.6 mm 12.6 mm 16.4 mm 21 mm



for / dla: YT-03315

POLYBAG WITH HEADER

YATO	Ø	
YT-03316	1/2" (12.7 mm)	100

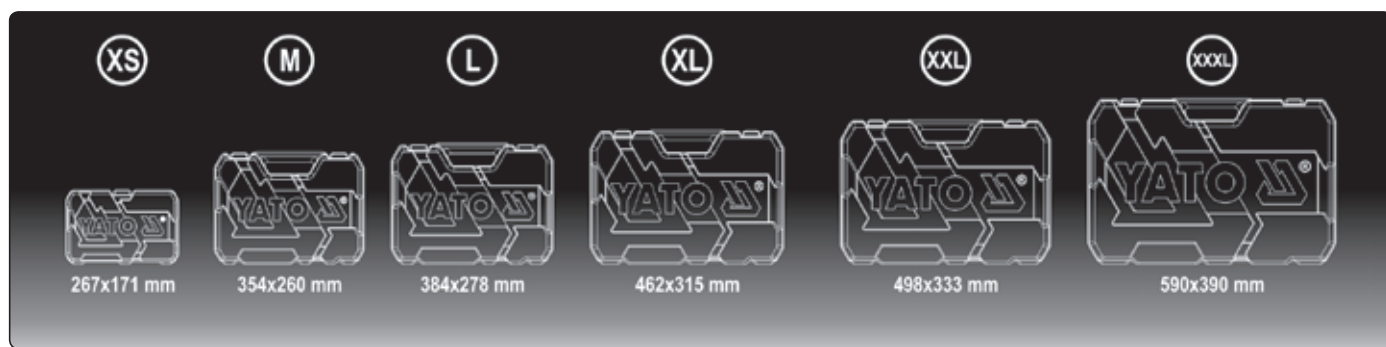

GB Socket set
 D Sechskant-Steckschlüssel-Satz
 PL Komplet nasadek długich
 RUS Набор насадок

CZ Sada nástrčných klíčů
 H Dugókulcs készlet
 RO Trusă chei tubulare
 F Set de douilles longues

I Serie di chiavi a bussola lunghi
 E Juego de herramientas
 CN 长套筒组套

PLASTIC HANGER



8 PCS	1/4" 6.3mm	CrV 50BV30	AS-DRIVE
----------	---------------	---------------	----------

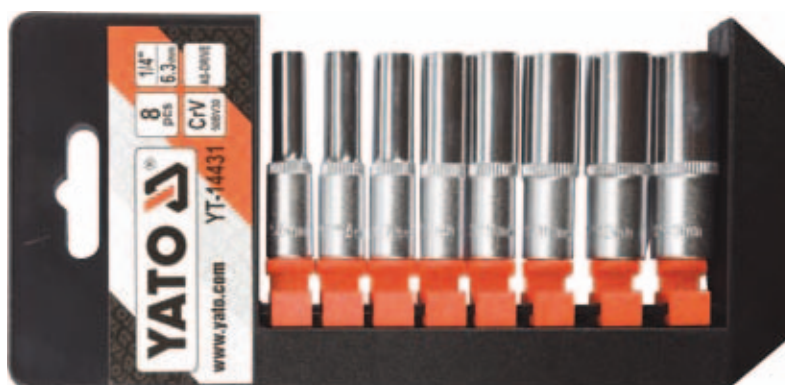

1/4" (6.3 mm): 5.5, 6, 7, 8, 9, 10, 12, 13 mm (L=50 mm); CrV 50BV30

YATO		
YT-14431	1/4" (6.3 mm)	10/20

GB Tool set
 D Sechskant-Steckschlüssel-Satz
 PL Zestaw narzędziowy
 RUS Набор инструмента
 CZ Sada nástrčných klíčů a ráčny
 H Dugókulcs készlet racsnis hajtókarral

RO Rotrusa chei tubulare cu antrenor
 F Coffret d'outillage
 I Set di utensili
 E Juego de herramientas
 CN 套筒扳手组套

BMC & COLOR SLEEVE
 XS SIZE



20 PCS	1/4" 6.3mm	CrV 50BV30	AS-DRIVE
CrMo 440	72T		



1/4" (6.3 mm): 3.5, 4, 4.5, 5, 5.5, 6, 7, 8, 9, 10, 11, 12, 13, 14 mm (L=25 mm); CrV 50BV30;
 1/4" (6.3 mm): (51.6, 151.5 mm); CrV 50BV30;
 1/4" (6.3 mm); CrV 50BV30;
 1/4" (6.3 mm): (152.8 mm); CrV 50BV30;
 1/4" (6.3 mm): (155 mm); 72T; CrMo 440;
 1/4" (6.3 mm): (150 mm); CrV 50BV30

YATO		
YT-14491	1/4" (6.3 mm)	10

GB Tool set
D Sechskant-Steckschlüssel-Satz
PL Zestaw narzędziowy
RUS Набор инструмента
CZ Sada nástrčných klíčů a ráčny
H Dugókulcs készlet racsnis hajtókkal

RO Rotrusa chei tubulare cu antrenor
F Coffret d'outillage
I Set di utensili
E Juego de herramientas
CN 套筒扳手组套

BMC & COLOR SLEEVE
XS SIZE



1/4"
6.3mm

CrV
50BV30

CrMo
440

72T

AS-DRIVE

2



23
PCS

- 1/4" (6.3 mm): 4, 5, 6, 7, 8, 9, 10, 12, 13 mm (L=25 mm); CrV 50BV30;
- 1/4" (6.3 mm): 4, 5, 6, 7, 8, 9, 10, 12, 13 mm (L=50 mm); CrV 50BV30;
- 1/4" (6.3 mm): (50.8, 152.4 mm); CrV 50BV30;
- 1/4" (6.3 mm); CrV 50BV30;
- 1/4" (6.3 mm): (155 mm); 72T; CrMo 440;
- 1/4" (6.3 mm): (150 mm); CrV 50BV30

YATO	Ø	
YT-14451	1/4" (6.3 mm)	10



25
PCS

CrV
40

- 1/4" (6.3 mm): 3.5, 4, 4.5, 5, 5.5, 6, 7, 8, 9, 10, 11, 12, 13, 14 mm (L=25 mm); CrV 50BV30;
- 1/4" (6.3 mm): 8, 10, 11, 12, 13 mm (L=50 mm); CrV 50BV30;
- 1/4" (6.3 mm): (50.8, 101.6 mm); CrV 50BV30;
- 1/4" (6.3 mm); CrV 50BV30;
- 1/4" (6.3 mm): (152.4 mm); CrV 40;
- 1/4" (6.3 mm): (155 mm); 72T; CrMo 440;
- 1/4" (6.3 mm): (150 mm); CrV 50BV30

YATO	Ø	
YT-14461	1/4" (6.3 mm)	10

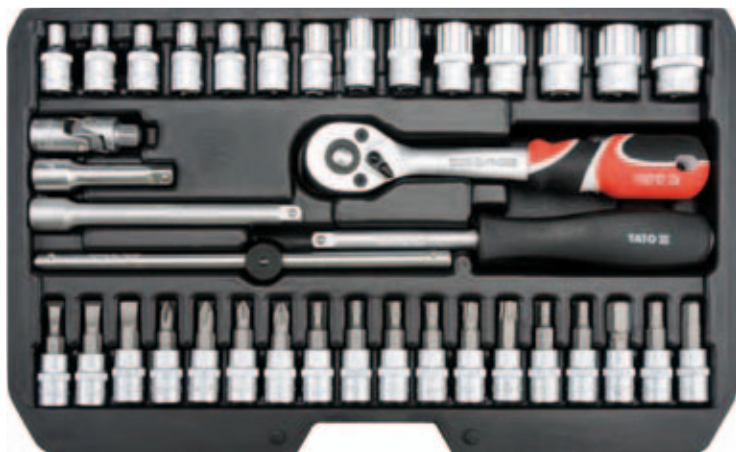

38
PCS

CrV
6150

CrV
40

S2

- 1/4" (6.3 mm): 3.5, 4, 4.5, 5, 5.5, 6, 7, 8, 9, 10, 11, 12, 13, 14 mm (L=25 mm); CrV 50BV30;
- 1/4" (6.3 mm): (50.8, 101.6 mm); CrV 50BV30;
- 1/4" (6.3 mm); CrV 50BV30;
- 1/4" (6.3 mm): (152.4 mm); CrV 40;
- 1/4" (6.3 mm): (155 mm); 72T; CrMo 440;
- 1/4" (6.3 mm): (150 mm); CrV 50BV30;
- 1/4" (6.3 mm): 4, 5.5, 6.5 mm (L=37 mm); AISI S2 / CrV 6150;
- 1/4" (6.3 mm): PH1, PH2 (L=37 mm); AISI S2 / CrV 6150;
- 1/4" (6.3 mm): PZ1, PZ2 (L=37 mm); AISI S2 / CrV 6150;
- 1/4" (6.3 mm): T10, T15, T20, T25, T30, T40 (L=37 mm); AISI S2 / CrV 6150;
- 1/4" (6.3 mm): 3, 4, 5, 6, 8 mm (L=37 mm); AISI S2 / CrV 6150

YATO	Ø	
YT-14471	1/4" (6.3 mm)	10

GB Tool set
 D Sechskant-Steckschlüssel-Satz
 PL Zestaw narzędziowy
 RUS Набор инструмента

CZ Sada nástrčných klíčů a ráčny
 H Dugókulcs készlet racsnis hajtókarral
 RO Rotruşa chei tubulare cu antrenor
 F Coffret d'outillage

I Set di utensili
 E Juego de herramientas
 CN 套筒扳手套

BMC & COLOR SLEEVE
 XS SIZE







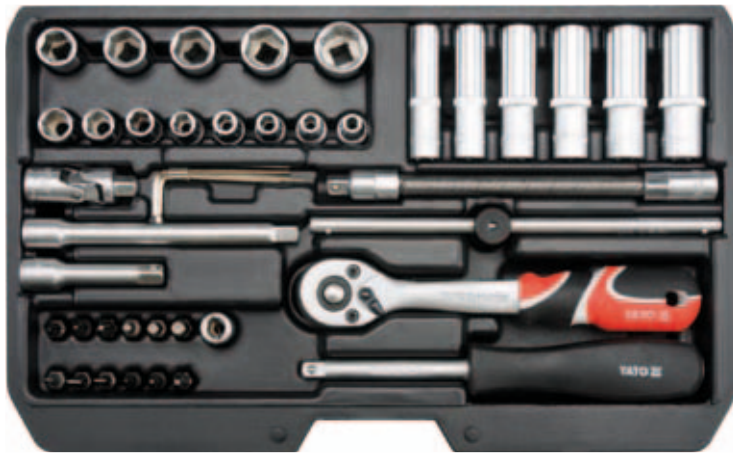











1/4" 6.3mm	CrV 50BV30	CrV 6150
CrV 40	CrMo 440	S2
72T	AS-DRIVE	

2

















42
PCS



-  1/4" (6.3 mm): 4, 4.5, 5, 5.5, 6, 7, 8, 9, 10, 11, 12, 13, 14 mm (L=25 mm); CrV 50BV30;
-  1/4" (6.3 mm): 8, 9, 10, 11, 12, 13 mm (L=50 mm); CrV 50BV30;
-  1/4" (6.3 mm): (50.8, 101.6 mm); CrV 50BV30;
-  1/4" (6.3 mm): (150 mm); CrV 50BV30;
-  1/4" (6.3 mm): CrV 50BV30;
-  1/4" (6.3 mm): (152.4 mm); CrV 40;
-  1/4" (6.3 mm): (155 mm); 72T; CrMo 440;
-  1/4" (6.3 mm): (150 mm); CrV 50BV30;
-  1/4" (6.3 mm) x 1/4" (6.3 mm): CrV 50BV30;
-  1/4" (6.3 mm): 3, 4, 5 mm (L=25 mm); AISI S2;
-  1/4" (6.3 mm): PH0, PH1, PH2 (L=25 mm); AISI S2;
-  1/4" (6.3 mm): PZ0, PZ1, PZ2 (L=25 mm); AISI S2;
-  1/4" (6.3 mm): 6, 7, 8 mm (L=25 mm); AISI S2;
-  1.5, 2.0, 2.5 mm; CrV 6150

YATO 		
YT-14481	1/4" (6.3 mm)	6



56
PCS

-  1/4" (6.3 mm): 4, 4.5, 5, 5.5, 6, 7, 8, 9, 10, 11, 12, 13 mm (L=25 mm); CrV 50BV30;
-  1/4" (6.3 mm): 6, 7, 8, 9, 10, 11, 12, 13 mm (L=50 mm); CrV 50BV30;
-  1/4" (6.3 mm): E4, E5, E6, E7, E8, E10; CrV 6150;
-  1/4" (6.3 mm): (76, 152.4 mm); CrV 50BV30;
-  1/4" (6.3 mm): (150 mm); CrV 50BV30;
-  1/4" (6.3 mm): CrV 50BV30;
-  1/4" (6.3 mm): (152.4 mm); CrV 40;
-  1/4" (6.3 mm): (155 mm); 72T; CrMo 440;
-  1/4" (6.3 mm): (150 mm); CrV 50BV30;
-  1/4" (6.3 mm) (F) x 3/8" (9.5 mm) (M); CrV 50BV30;
-  1/4" (6.3 mm): 4, 5.5, 6.5 mm (L=37 mm); AISI S2 / CrV 6150;
-  1/4" (6.3 mm): PH1, PH2, PH3 (L=37 mm); AISI S2 / CrV 6150;
-  1/4" (6.3 mm): PZ1, PZ2, PZ3 (L=37 mm); AISI S2 / CrV 6150;
-  1/4" (6.3 mm): T8, T10, T15, T20, T25, T30, T40 (L=37 mm); AISI S2 / CrV 6150;
-  1/4" (6.3 mm): 3, 4, 5, 6, 7, 8 mm (L=37 mm); AISI S2 / CrV 6150

YATO 		
YT-14501	1/4" (6.3 mm)	10

GB Tool set
 D Sechskant-Steckschlüssel-Satz
 PL Zestaw narzędziowy
 RUS Набор инструмента

CZ Sada nástrčných klíčů a ráčny
 H Dugókulcs készlet racsnis hajtókarral
 RO Rotrușă chei tubulare cu antrenor
 F Coffret d'outillage

I Set di utensili
 E Juego de herramientas
 CN 套筒扳手组套

BMC & COLOR SLEEVE
 XS SIZE



22 PCS	3/8" 10mm	CrV 50BV30	CrV 40
		CrMo 440	72T AS-DRIVE



- 3/8" (9.5 mm): 6, 7, 8, 9, 10, 11, 12, 13, 14, 15, 16 mm (L=28 mm);
17, 18, 19, 20, 21, 22 mm (L=30 mm); CrV 50BV30;
- 3/8" (9.5 mm): (76, 152.4 mm); CrV 50BV30;
- 3/8" (9.5 mm): CrV 50BV30;
- 3/8" (9.5 mm): (198 mm); CrV 40;
- 3/8" (9.5 mm): (200 mm); 72T; CrMo 440

YATO	○	
YT-38561	3/8" (9.5 mm)	10

GB Socket set
 D Sechskant-Steckschlüssel-Satz
 PL Komplet nasadek dlugich
 RUS Набор насадок

CZ Sada nástrčných klíčů
 H Dugókulcs készlet
 RO Trusă chei tubulare
 F Set de douilles longues

I Serie di chiavi a bussola lunghi
 E Juego de herramientas
 CN 长套筒组套

PLASTIC HANGER



10 PCS	1/2" 12.5mm	CrV 50BV30	AS-DRIVE
-----------	----------------	---------------	----------



1/2" (12.7 mm): 10, 12, 13, 14, 15, 17, 19, 21, 22, 24 mm (L=76 mm); CrV 50BV30

YATO	○	
YT-38861	1/2" (12.7 mm)	5/10

GB Socket set
 D Sechskantenschlüssel-Einsatz
 PL Komplet nasadek z akcesoriami
 RUS Набор торцевых головок

CZ Sada nástrčných klíčů a ráčny
 H Dugókulcs készlet racsnis hajtókarral
 RO Trusă chei tubulare cu antrenor
 F Set de douilles + accessoires

I Serie di chiavi a con accessori
 E Juego de boquillas con accesorios
 CN 套筒扳手组套

PLASTIC HANGER



12 PCS	1/2" 12.5mm	CrV 50BV30	72T AS-DRIVE
CrMo 440			



1/2" (12.7 mm): 10, 11, 12, 13, 14, 15, 17, 19, 21, 24 mm (L=38 mm); CrV 50BV30;
 1/2" (12.7 mm): (127 mm); CrV 50BV30;
 1/2" (12.7 mm): (255 mm); 72T; CrMo 440

YATO	○	
YT-38821	1/2" (12.7 mm)	5/10

GB Ratchet handle with socket set
 D Sechskant-Steckschlüssel-Satz
 PL Komplet nasadek z grzechotką
 RUS Набор насадок

CZ Sada nástrčných klíčů a ráčny
 H Dugókulcs készlet racsnis hajtókarral
 RO Rotrusa chei tubulare cu antrenor
 F Clé mixte à cliquet + douilles

I Serie di chiavi con cricchetto
 E Matraca con boquillas
 CN 套筒扳手组套

PLASTIC HANGER



19 PCS	1/2" 12.5mm	CrV 50BV30
CrMo 440	72T	AS-DRIVE



1/2" (12.7 mm): 8, 9, 10, 11, 12, 13, 14, 15, 16, 17, 19, 21, 22, 23, 24 mm (L=38 mm);
 27, 30, 32 mm (L=42 mm); CrV 50BV30;
 1/2" (12.7 mm); (255 mm); 72T; CrMo 440

YATO	○	
YT-38681	1/2" (12.7 mm)	3/6

GB Tool set
 D Sechskant-Steckschlüssel-Satz
 PL Zestaw narzędziowy
 RUS Набор инструмента

CZ Sada nástrčných klíčů a ráčny
 H Dugókulcs készlet racsnis hajtókarral
 RO Rotrusa chei tubulare cu antrenor
 F Coffret d'outillage

I Set di utensili
 E Juego de herramientas
 CN 套筒扳手组套

1/2" 12.5mm	CrV 50BV30	72T	AS-DRIVE
----------------	---------------	-----	----------



12 PCS	CrMo 440
-----------	-------------

1/2" (12.7 mm): 10, 11, 12, 13, 14, 15, 17, 19, 21, 24 mm
 (L=38 mm); CrV 50BV30;
 1/2" (12.7 mm); (127 mm); CrV 50BV30;
 1/2" (12.7 mm); (255 mm); 72T; CrMo 440

YATO	○	
YT-38671	1/2" (12.7 mm)	10

BMC & COLOR SLEEVE
 XS SIZE

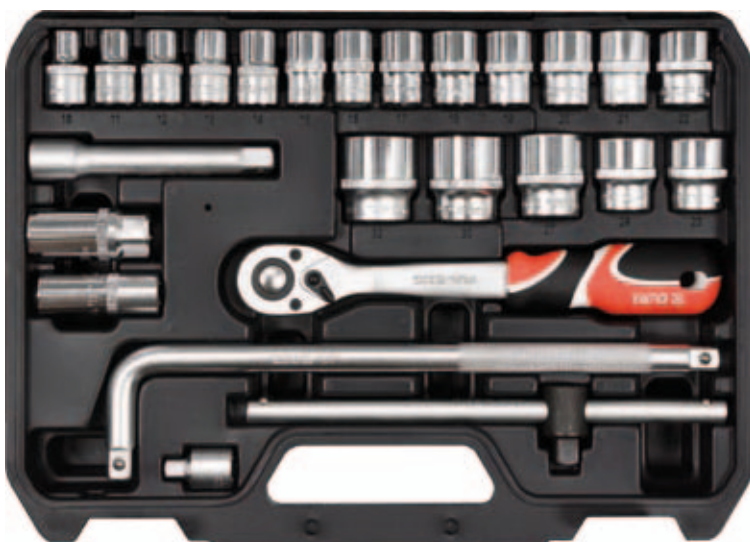

25 PCS	CrV 6140
-----------	-------------

1/2" (12.7 mm): 10, 11, 12, 13, 14, 15, 16, 17, 18, 19, 20,
 21, 22, 23, 24 mm (L=38 mm); 27, 30, 32 mm (L=42 mm);
 1/2" (12.7 mm); (127 mm); CrV 50BV30;
 1/2" (12.7 mm): 16, 21 mm; CrV 50BV30;
 1/2" (12.7 mm); (255 mm); CrV 50BV30;
 1/2" (12.7 mm); (255 mm);
 1/2" (12.7 mm); (317 mm); CrV 50BV30;
 1/2" (12.7 mm) (F) x 3/8" (9.5 mm) (M); CrV 50BV30

YATO	○	
YT-38741	1/2" (12.7 mm)	2

BMC & COLOR SLEEVE
 L SIZE



GB Tool set
D Sechskant-Steckschlüssel-Satz
PL Zestaw narzędziowy
RUS Набор инструмента

CZ Sada nástrčných klíčů a ráčny
H Dugókulcs készlet racsnis hajtókarral
RO Rotrusa chei tubulare cu antrenor
F Coffret d'outillage

I Set di utensili
E Juego de herramientas
CN 套筒扳手组套

1/2"
12.5mm
1/4"
6.3mm
CrV
50BV30
S2
72T
AS-DRIVE

2



BMC & COLOR SLEEVE
L SIZE



77
PCS
CrV
6150
CrMo
440

- 1/2" (12.7 mm): 10, 11, 12, 13, 14, 15, 17, 19, 22, 24 mm (L=38 mm); 27, 30, 32 mm (L=42 mm);
- 1/4" (6.3 mm): 4, 5, 6, 7, 8, 9, 10, 11, 12 mm (L=25 mm); CrV 50BV30;
- 1/2" (12.7 mm): (127, 254 mm);
- 1/4" (6.3 mm): (76, 101.6 mm); CrV 50BV30;
- 1/2" (12.7 mm), 1/4" (6.3 mm): CrV 50BV30;
- 1/2" (12.7 mm): 16, 21 mm; CrV 50BV30;
- 1/2" (12.7 mm): (255 mm);
- 1/4" (6.3 mm): (155 mm); 72T; CrMo 440;
- 1/4" (6.3 mm) x 1/4" (6.3 mm): CrV 50BV30;
- 1/4" (6.3 mm) x 1/4" (6.3 mm); CrV 50BV30;
- 1/4" (6.3 mm): 3, 4, 5.5, 7 mm (L=25 mm); AISI S2;
- 1/4" (6.3 mm): PH0, PH1, PH2, PH3 (L=25 mm); AISI S2;
- 1/4" (6.3 mm): PZ1, PZ2, PZ3 (L=25 mm); AISI S2;
- 1/4" (6.3 mm): T10, T15, T20, T25, T30 (L=25 mm); AISI S2;
- 1/4" (6.3 mm): 2, 3, 4, 5, 6 mm (L=25 mm); AISI S2;
- 7, 8, 9, 10, 11, 12, 13, 14, 15, 17, 19 mm; CrV;
- 8x9, 10x11, 12x13, 14x15 mm; CrV 50BV30;
- 1.5, 2, 2.5, 5, 6, 8, 10 mm; CrV 6150

YATO	1/2" (12.7 mm)	1/4" (6.3 mm)	2
YT-38781			



BMC & COLOR SLEEVE
XXXL SIZE



79
PCS
CrV
6140
CrV
60
CrMo
SK5

- 1/2" (12.7 mm): 10, 11, 12, 13, 14, 16, 17, 19, 22, 24, 26 mm (L=38 mm); 27, 30, 32 mm (L=42 mm);
- 1/4" (6.3 mm): 5, 6, 7, 8, 9, 10, 11, 12, 13 mm (L=25 mm); CrV 50BV30;
- 1/2" (12.7 mm): 10, 11, 12, 13, 14, 17, 19 mm (L=76 mm); CrV 50BV30;
- 1/2" (12.7 mm): (125 mm);
- 1/4" (6.3 mm): (50 mm); CrV 50BV30;
- 1/2" (12.7 mm); CrV 50BV30;
- 1/2" (12.7 mm): 16, 21 mm; CrV 50BV30;
- 1/2" (12.7 mm): (255 mm);
- 1/4" (6.3 mm): (155 mm); 72T; CrV 6140;
- 1/4" (6.3 mm): (150 mm); CrV 50BV30;
- 1/2" (12.7 mm): (457 mm);
- 6, 7, 8, 9, 10, 11, 12, 13, 14, 16, 17, 19, 22, 24 mm; CrV;
- 2.0x50, 2.4x75 mm, S2;
- 3.0x75, 4.0x100, 6.5x150, 8.0x150 mm; S2;
- PH0x75 mm; S2; PH1x75, PH2x100 mm; S2;
- 180 mm; 160 mm;
- 160, 200 mm; 250 mm;
- 300 g; 300 mm;
- 180 mm; CrMo; 120 mm; CrV 60;
- SK5;
- 2.5, 3, 4, 5, 6, 8, 10 mm; CrV

YATO	1/2" (12.7 mm)	1/4" (6.3 mm)	2
YT-38911			

GB Tool set
 D Sechskant-Steckschlüssel-Satz
 PL Zestaw narzędziowy
 RUS Набор инструмента

CZ Sada nástrčných klíčů a ráčny
 H Dugókulcs készlet racsnis hajtókarral
 RO Rotrusa chei tubulare cu antrenor
 F Coffret d'outillage

I Set di utensili
 E Juego de herramientas
 CN 套筒扳手套

BMC & COLOR SLEEVE
 L SIZE

1/2"	1/4"
12.5mm	6.3mm
CrV 50BV30	CrV 6150
CrV 40	CrMo 440
S2	72T
AS-DRIVE	



2



82
 PCS

1/2" (12.7 mm): 14, 15, 16, 17, 18, 19, 20, 22, 24 mm (L=38 mm); 27, 30, 32 mm (L=42 mm), 1/4" (6.3 mm): 4, 4.5, 5, 5.5, 6, 7, 8, 9, 10, 11, 12, 13, 14 mm (L=25 mm); CrV 50BV30; 1/2" (12.7 mm): (127, 254 mm), 1/4" (6.3 mm): (50.8, 101.6 mm); CrV 50BV30; 3/8" (9.5 mm) (F) x 1/2" (12.7 mm) (M); CrV 50BV30; 1/4" (6.3 mm); CrV 50BV30; 1/2" (12.7 mm), 1/4" (6.3 mm); CrV 50BV30; 1/2" (12.7 mm): 16, 21 mm; CrV 50BV30; 1/4" (6.3 mm); (152.4 mm); CrV 40; 1/2" (12.7 mm); (255 mm), 1/4" (6.3 mm); (155 mm); 72T; CrMo 440; 1/4" (6.3 mm); (150 mm); CrV 50BV30; 1/2" (12.7 mm) x 5/16" (7.9 mm); CrV 50BV30; 1/4" (6.3 mm) x 1/4" (6.3 mm); CrV 50BV30; 5/16" (7.9 mm): 8, 10, 12 mm (L=30 mm); AISI S2; 5/16" (7.9 mm); PH3, PH4 (L=30 mm); AISI S2; 5/16" (7.9 mm); PZ3, PZ4 (L=30 mm); AISI S2; 5/16" (7.9 mm): T40, T45, T50, T55 (L=30 mm); AISI S2; 5/16" (7.9 mm): 8, 10, 12, 14 mm (L=30 mm); AISI S2; 1/4" (6.3 mm): 4, 5, 5, 7 mm (L=37 mm); AISI S2 / CrV 6150; 1/4" (6.3 mm): PH1, PH2 (L=37 mm); AISI S2 / CrV 6150; 1/4" (6.3 mm): PZ1, PZ2 (L=37 mm); AISI S2 / CrV 6150; 1/4" (6.3 mm): T8, T10, T15, T20, T25, T30 (L=37 mm); AISI S2 / CrV 6150; 1/4" (6.3 mm): 3, 4, 5, 6 mm (L=37 mm); AISI S2 / CrV 6150; 8, 10, 11, 12, 13, 14, 17, 19, 22 mm; CrV

YATO	1/2" (12.7 mm)	1/4" (6.3 mm)	2
YT-12691	1/2" (12.7 mm)	1/4" (6.3 mm)	2



94
 PCS

1/2" (12.7 mm): 10, 11, 12, 13, 14, 15, 16, 17, 18, 19, 20, 21, 22, 23, 24 mm (L=38 mm); 27, 30, 32 mm (L=42 mm), 1/4" (6.3 mm): 4, 4.5, 5, 5.5, 6, 7, 8, 9, 10, 11, 12, 13, 14 mm (L=25 mm); CrV 50BV30; 1/2" (12.7 mm): 14, 15, 17, 19 mm (L=76 mm), 1/4" (6.3 mm): 6, 7, 8, 9, 10, 11, 12, 13 mm (L=50 mm); CrV 50BV30; 1/2" (12.7 mm): (127, 254 mm), 1/4" (6.3 mm): (50.8, 101.6 mm); CrV 50BV30; 3/8" (9.5 mm) (F) x 1/2" (12.7 mm) (M); CrV 50BV30; 1/4" (6.3 mm); (150 mm); CrV 50BV30; 1/2" (12.7 mm), 1/4" (6.3 mm); CrV 50BV30; 1/2" (12.7 mm): 16, 21 mm; CrV 50BV30; 1/4" (6.3 mm); (152.4 mm); CrV 40; 1/2" (12.7 mm); (255 mm), 1/4" (6.3 mm); (155 mm); 72T; CrMo 440; 1/4" (6.3 mm); (150 mm); CrV 50BV30; 1/2" (12.7 mm) x 5/16" (7.9 mm); CrV 50BV30; 1/4" (6.3 mm) x 1/4" (6.3 mm); CrV 50BV30; 5/16" (7.9 mm): 8, 10, 12 mm (L=30 mm); AISI S2; 5/16" (7.9 mm); PH3, PH4 (L=30 mm); AISI S2; 5/16" (7.9 mm): PZ3, PZ4 (L=30 mm); AISI S2; 5/16" (7.9 mm): T40, T45, T50, T55 (L=30 mm); AISI S2; 5/16" (7.9 mm): 8, 10, 12, 14 mm (L=30 mm); AISI S2; 1/4" (6.3 mm): 4, 5, 5, 7 mm (L=37 mm); AISI S2 / CrV 6150; 1/4" (6.3 mm): PH1, PH2 (L=37 mm); AISI S2 / CrV 6150; 1/4" (6.3 mm): PZ1, PZ2 (L=37 mm); AISI S2 / CrV 6150; 1/4" (6.3 mm): T8, T10, T15, T20, T25, T30 (L=37 mm); AISI S2 / CrV 6150; 1/4" (6.3 mm): 3, 4, 5, 6 mm (L=37 mm); AISI S2 / CrV 6150; 1.5, 2, 2.5 mm; CrV 6150

YATO	1/2" (12.7 mm)	1/4" (6.3 mm)	2
YT-12681	1/2" (12.7 mm)	1/4" (6.3 mm)	2

GB Tool set
D Sechskant-Steckschlüssel-Satz
PL Zestaw narzędziowy
RUS Набор инструмента

CZ Sada nástrčných klíčů a ráčny
H Dugókulcs készlet racsnis hajtókarral
RO Rotrusa chei tubulare cu antrenor
F Coffret d'outillage

I Set di utensili
E Juego de herramientas
CN 套筒扳手组套

1/2" 12.5mm	1/4" 6.3mm
CrV 50BV30	CrV 6150
CrMo 440	S2
72T	AS-DRIVE



108
PCS

CrV
40

BMC & COLOR SLEEVE
L SIZE



1/2" (12.7 mm): 10, 11, 12, 13, 14, 15, 16, 17, 18, 19, 20, 21, 22, 24 mm (L=38 mm); 27, 30, 32 mm (L=42 mm), 1/4" (6.3 mm): 4, 4.5, 5, 5.5, 6, 7, 8, 9, 10, 11, 12, 13, 14 mm (L=25 mm); CrV 50BV30: 1/2" (12.7 mm): 14, 15, 17, 19, 22 mm (L=76 mm), 1/4" (6.3 mm): 6, 7, 8, 9, 10, 11, 12, 13 mm (L=50 mm); CrV 50BV30: 1/2" (12.7 mm): E10, E11, E12, E14, E16, E18, E20, E24, 1/4" (6.3 mm): E4, E5, E6, E7, E8; CrV 6150: 1/2" (12.7 mm): (127, 254 mm), 1/4" (6.3 mm): (50.8, 101.6 mm); CrV 50BV30: 3/8" (9.5 mm) (F) x 1/2" (12.7 mm) (M); CrV 50BV30: 1/2" (12.7 mm), 1/4" (6.3 mm); CrV 50BV30: 1/2" (12.7 mm): 16, 21 mm; CrV 50BV30: 1/4" (6.3 mm); (152.4 mm); CrV 40: 1/2" (12.7 mm); (255 mm), 1/4" (6.3 mm); (155 mm); 72T; CrMo 440: 1/4" (6.3 mm); (150 mm); CrV 50BV30: 1/2" (12.7 mm) x 5/16" (7.9 mm); CrV 50BV30: 5/16" (7.9 mm): 8, 10, 12 mm (L=30 mm); AISI S2: 5/16" (7.9 mm): PH3, PH4 (L=30 mm); AISI S2: 5/16" (7.9 mm): PZ3, PZ4 (L=30 mm); AISI S2: 5/16" (7.9 mm): T40, T45, T50, T55, T60 (L=30 mm); AISI S2: 5/16" (7.9 mm): 7, 8, 10, 12, 14 mm (L=30 mm); AISI S2: 1/4" (6.3 mm): 4, 5, 5.5, 6, 5 mm (L=37 mm); AISI S2 / CrV 6150: 1/4" (6.3 mm): PH1, PH2 (L=37 mm); AISI S2 / CrV 6150: 1/4" (6.3 mm): PZ1, PZ2 (L=37 mm); AISI S2 / CrV 6150: 1/4" (6.3 mm): T8, T10, T15, T20, T25, T27, T30 (L=37 mm); AISI S2 / CrV 6150: 1/4" (6.3 mm): 3, 4, 5, 6 mm (L=37 mm); AISI S2 / CrV 6150: 1.5, 2, 2.5 mm; CrV 6150

YATO	1/2" (12.7 mm)	1/4" (6.3 mm)	2
YT-38791			



109
PCS

CrV
6140

BMC & COLOR SLEEVE
XXL SIZE



1/2" (12.7 mm): 12, 13, 14, 15, 16, 17, 18, 19, 20, 21, 22, 24 mm (L=38 mm); 27, 30, 32 mm (L=42 mm), 1/4" (6.3 mm): 4, 4.5, 5, 5.5, 6, 7, 8, 9, 10, 11, 12, 13, 14 mm (L=25 mm); CrV 50BV30: 1/2" (12.7 mm): 10, 12, 13, 14, 17, 19 mm (L=76 mm), 1/4" (6.3 mm): 4, 5, 6, 7, 8, 9 mm (L=50 mm); CrV 50BV30: 1/2" (12.7 mm): E10, E12, E14, E16, E18, E20, E22, E24; CrV 6150: 1/2" (12.7 mm): (254 mm), 1/4" (6.3 mm): (152.4 mm); CrV 50BV30: 3/8" (9.5 mm) (F) x 1/2" (12.7 mm) (M), 3/8" (9.5 mm) (F) x 1/4" (6.3 mm) (M); CrV 50BV30: 1/2" (12.7 mm), 1/4" (6.3 mm); CrV 50BV30: 1/2" (12.7 mm): 16, 21 mm; CrV 50BV30: 1/2" (12.7 mm): (255 mm), 1/4" (6.3 mm): (155 mm); 72T; CrMo 440: 1/4" (6.3 mm); (150 mm); CrV 50BV30: 1/2" (12.7 mm) x 5/16" (7.9 mm); AISI S2 / CrV 6150: 5/16" (7.9 mm): PH1, PH2, PH3 (L=37 mm); AISI S2 / CrV 6150: 5/16" (7.9 mm): PZ2, PZ3 (L=37 mm); AISI S2 / CrV 6150: 5/16" (7.9 mm): T8, T10, T15, T20, T25 (L=37 mm); AISI S2 / CrV 6150: 5/16" (7.9 mm): T10, T15, T20, T25, T40 (L=37 mm); AISI S2 / CrV 6150: 1/4" (6.3 mm): 3, 4, 5, 6 mm (L=37 mm); AISI S2 / CrV 6150: 1/4" (6.3 mm): 8, 9, 10, 11, 12, 13, 14, 15, 16, 17, 18, 19 mm; CrV: 8x9, 10x11, 12x13, 14x15 mm; CrV 50BV30: 8x10, 12x13, 17x19 mm; CrV 6140: 3x75, 4x100, 6x150, PH1x75, PH2x100, PH3x150 mm; S2: 180 mm; 160 mm; 300 g

YATO	1/2" (12.7 mm)	1/4" (6.3 mm)	2
YT-38891			

GB Tool set
D Sechskant-Steckschlüssel-Satz
PL Zestaw narzędziowy
RUS Набор инструмента

CZ Sada nástrčných klíčů a ráčny
H Dugókulcs készlet racsni hajtókarral
RO Roturusa chei tubulare cu antrenor
F Coffret d'outillage

I Set di utensili
E Juego de herramientas
CN 套筒扳手组套

BMC & COLOR SLEEVE
XL SIZE



1/2" 12.5mm	3/8" 10mm	1/4" 6.3mm
CrV 50BV30	CrV 6150	S2
72T	AS-DRIVE	

2

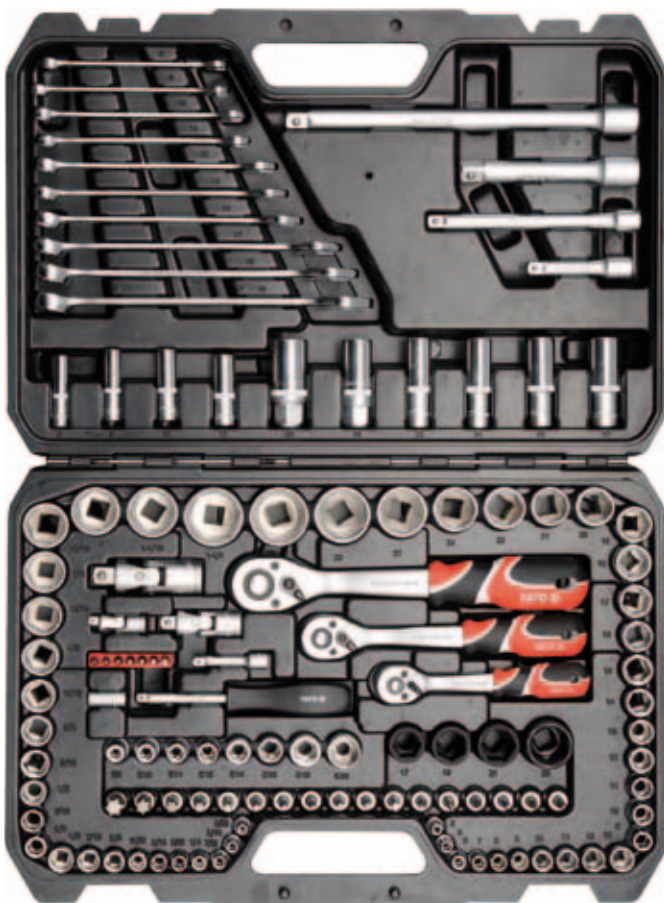

120
PCS

METRIC
& S.A.E.

CrMo
440

1/2" (12.7 mm): 20, 21, 22, 24 mm (L=38 mm); 27, 30, 32 mm (L=42 mm), 3/8" (9.5 mm): 9, 10, 11, 12, 13, 14, 15, 16 mm (L=28 mm); 17, 18, 19 mm (L=30 mm), 1/4" (6.3 mm): 4, 5, 6, 7, 8, 9, 10, 11, 12, 13 mm (L=25 mm); CrV 50BV30: □ 3/8" (9.5 mm): 13, 14, 15, 17 mm (L=63 mm), 1/4" (6.3 mm): 8, 9, 10, 12 mm (L=50 mm); CrV 50BV30: □ 1/2" (12.7 mm) x 15/16" (23.8 mm), 1/2" (12.7 mm) x 1" (25.4 mm), 1/2" (12.7 mm) x 1-1/16" (27.0 mm), 1/2" (12.7 mm) x 1-1/4" (31.8 mm), 3/8" (9.5 mm) x 3/8" (9.5 mm), 3/8" (9.5 mm) x 7/16" (11.1 mm), 3/8" (9.5 mm) x 1/2" (12.7 mm), 3/8" (9.5 mm) x 9/16" (14.3 mm), 3/8" (9.5 mm) x 5/8" (15.9 mm), 3/8" (9.5 mm) x 11/16" (17.5 mm), 3/8" (9.5 mm) x 3/4" (19.0 mm), 3/8" (9.5 mm) x 13/16" (20.6 mm), 3/8" (9.5 mm) x 7/8" (22.2 mm), 1/4" (6.3 mm) x 5/32" (4.0 mm), 1/4" (6.3 mm) x 3/16" (4.8 mm), 1/4" (6.3 mm) x 7/32" (5.6 mm), 1/4" (6.3 mm) x 1/4" (6.3 mm), 1/4" (6.3 mm) x 9/32" (7.1 mm), 1/4" (6.3 mm) x 5/16" (7.9 mm), 1/4" (6.3 mm) x 11/32" (8.7 mm), 1/4" (6.3 mm) x 3/8" (9.5 mm), 1/4" (6.3 mm) x 7/16" (11.1 mm), 1/4" (6.3 mm) x 1/2" (12.7 mm); CrV 50BV30: □ 1/2" (12.7 mm): 17, 19, 21, 23 mm; CrV 50BV30: □ 3/8" (9.5 mm): E8, E10, E11, E12, E14, E16, E18, E20; CrV 6150: □ 1/2" (12.7 mm): (127, 254 mm), 3/8" (9.5 mm): (76, 152.4 mm), 1/4" (6.3 mm): (50.8 mm); CrV 50BV30: □ 1/2" (12.7 mm), 3/8" (9.5 mm), 1/4" (6.3 mm); CrV 50BV30: □ 3/8" (9.5 mm): 16, 21 mm; CrV 50BV30: □ 1/2" (12.7 mm): (255 mm), 3/8" (9.5 mm): (200 mm), 1/4" (6.3 mm): (155 mm); 72T; CrMo 440: □ 1/4" (6.3 mm): (150 mm); CrV 50BV30: □ 1/4" (6.3 mm) x 1/4" (6.3 mm); CrV 50BV30: □ 1/4" (6.3 mm): T10, T15, T20, T25, T27, T30, T40 (L=25 mm); AISI S2: □ 3/8" (9.5 mm): 5.5, 6.5 mm (L=50 mm); AISI S2 / CrV 6150: □ 3/8" (9.5 mm): PH1, PH2 (L=50 mm); AISI S2 / CrV 6150: □ 3/8" (9.5 mm): PZ1, PZ2 (L=50 mm); AISI S2 / CrV 6150: □ 3/8" (9.5 mm): T20, T30, T40, T45, T50, T55, T60 (L=50 mm); AISI S2 / CrV 6150: □ 3/8" (9.5 mm): 3, 4, 5, 6 mm (L=50 mm); AISI S2 / CrV 6150: □ 8, 9, 10, 11, 12, 13, 14, 17, 18, 19 mm; CrV

YATO	□	□	□	□
YT-38801	1/2" (12.7 mm)	3/8" (9.5 mm)	1/4" (6.3 mm)	2

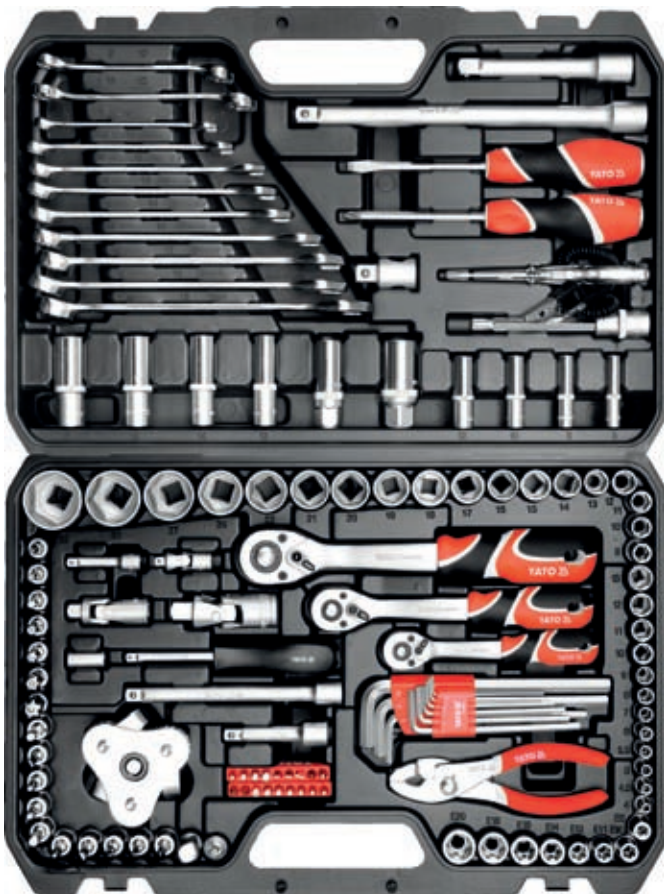

126
PCS

CrV
6140

1/2" (12.7 mm): 20, 21, 22, 24 mm (L=38 mm); 27, 30, 32 mm (L=42 mm), 3/8" (9.5 mm): 9, 10, 11, 12, 13, 14, 15, 16 mm (L=28 mm); 17, 18, 19 mm (L=30 mm), 1/4" (6.3 mm): 4, 4.5, 5, 5.5, 6, 7, 8, 9, 10, 11, 12, 13 mm (L=25 mm); CrV 50BV30: □ 3/8" (9.5 mm): 13, 14, 15, 17 mm (L=63 mm), 1/4" (6.3 mm): 8, 9, 10, 12 (L=50 mm); CrV 50BV30: □ 3/8" (9.5 mm): E8, E10, E11, E12, E14, E16, E18, E20; CrV 6150: □ 1/2" (12.7 mm): (127, 254 mm), 3/8" (9.5 mm): (76, 152.4 mm), 1/4" (6.3 mm): (50.8 mm); CrV 50BV30: □ 1/2" (12.7 mm) (F) x 3/8" (9.5 mm) (M), 3/8" (9.5 mm) (F) x 1/2" (12.7 mm) (M); CrV 50BV30: □ 1/2" (12.7 mm), 3/8" (9.5 mm), 1/4" (6.3 mm); CrV 50BV30: □ 3/8" (9.5 mm): 16, 21 mm; CrV 50BV30: □ 1/2" (12.7 mm): (255 mm), 3/8" (9.5 mm): (200 mm), 1/4" (6.3 mm): (155 mm); 72T; CrV 6140: □ 1/4" (6.3 mm): (150 mm); CrV 50BV30: □ 1/2" (12.7 mm) (F) x 3/8" (9.5 mm) (M), 3/8" (9.5 mm) (F) x 1/2" (12.7 mm) (M), 3/8" (9.5 mm) (F) x 1/4" (6.3 mm) (M); CrV 50BV30: □ 1/4" (6.3 mm) x 1/4" (6.3 mm); CrV 6140: □ 1/4" (6.3 mm): 4, 5, 6.5 mm (L=25 mm); AISI S2: □ 1/4" (6.3 mm): PH1, PH3 (L=25 mm); AISI S2: □ 1/4" (6.3 mm): PZ1, PZ2 (L=25 mm); AISI S2: □ 1/4" (6.3 mm): T10, T15, T20, T25, T27, T30, T40 (L=25 mm); AISI S2: □ 1/4" (6.3 mm): 3, 4, 5, 6 mm (L=25 mm); AISI S2: □ 3/8" (9.5 mm): 5.5, 6.5 mm (L=50 mm); AISI S2 / CrV 6150: □ 3/8" (9.5 mm): PH1, 2xPH2 (L=50 mm); AISI S2 / CrV 6150: □ 3/8" (9.5 mm): T20, T30, T40 (L=50 mm); AISI S2 / CrV 6150: □ 3/8" (9.5 mm): T45, T50, T55, T60 (L=50 mm); AISI S2 / CrV 6150: □ 3/8" (9.5 mm): 3, 4, 5, 6, 7 mm (L=50 mm); AISI S2 / CrV 6150: □ 1/2" (12.7 mm): M10 (L=100 mm); AISI S2 / CrV 6150: □ 8, 10, 12, 13, 14, 16, 17, 18, 19 mm; CrV: □ 8x10 mm, 11x12 mm; CrV 6140: □ 6x100 mm, PH2x100 mm; CrV 6150: □ 6-24 V; □ 1/2" (12.7 mm), 3/8" (9.5 mm): 63-120 mm; CrV: □ 1.5, 2, 2.5, 3, 4, 5, 6, 8, 10 mm; S2

YATO	□	□	□	□
YT-38875	1/2" (12.7 mm)	3/8" (9.5 mm)	1/4" (6.3 mm)	2

GB Tool set
 D Sechskant-Steckschlüssel-Satz
 PL Zestaw narzędziowy
 RUS Набор инструмента

CZ Sada nástrčných klíčů a ráčny
 H Dugókulcs készlet racsnis hajtókarral
 RO Rotrușă chei tubulare cu antrenor
 F Coffret d'outillage

I Set di utensili
 E Juego de herramientas
 CN 套筒扳手套

1/2" 12.5mm	3/8" 10mm	1/4" 6.3mm
CrV 50BV30	CrV 6150	CrMo 440
S2	72T	AS-DRIVE

2

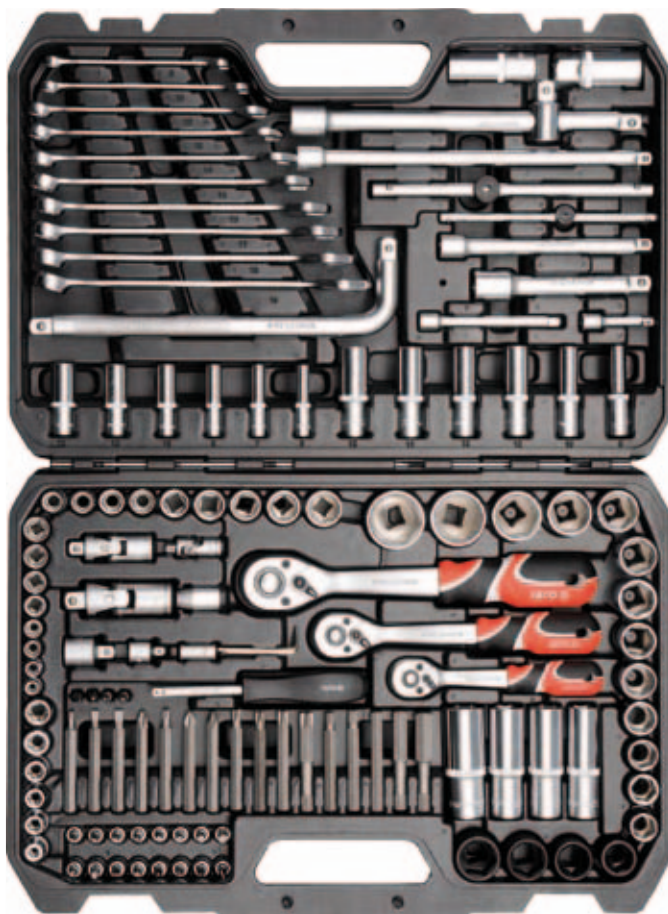

128
PCS

BMC & COLOR
SLEEVE
XL SIZE



1/2" (12.7 mm): 14, 15, 16, 17, 18, 19, 20, 21, 22, 24 mm (L=38 mm); 27, 30, 32 mm (L=42 mm); 3/8" (9.5 mm): 10, 11, 12, 13, 14, 15, 16 mm (L=28 mm); 17, 18 mm (L=30 mm); 1/4" (6.3 mm): 6, 7, 8, 9, 10, 11, 12, 13 mm (L=25 mm); CrV 50BV30: 1/2" (12.7 mm): 17, 18, 19, 22 mm (L=76 mm); 3/8" (9.5 mm): 8, 10, 12, 13, 14, 15 mm (L=63 mm); 1/4" (6.3 mm): 6, 7, 8, 10, 12, 13 mm (L=50 mm); CrV 50BV30: 1/2" (12.7 mm): 17, 19, 21, 22 mm; CrV 50BV30: 3/8" (9.5 mm): E8, E10, E11, E12, E14, E16; CrV 6150: 1/2" (12.7 mm): (127, 254 mm); 3/8" (9.5 mm): (152.4, 254 mm); 1/4" (6.3 mm): (50.8, 101.6 mm); CrV 50BV30: 3/8" (9.5 mm) (F) x 1/2" (12.7 mm) (M); CrV 50BV30: 1/2" (12.7 mm); 3/8" (9.5 mm); 1/4" (6.3 mm); CrV 50BV30: 1/2" (12.7 mm): 16, 21 mm; CrV 50BV30: 3/8" (9.5 mm): (198 mm); 1/4" (6.3 mm): (152.4 mm); CrV 50BV30: 1/2" (12.7 mm): (255 mm); 3/8" (9.5 mm): (200 mm); 1/4" (6.3 mm): (155 mm); 72T; CrMo 440: 1/4" (6.3 mm): (150 mm); CrV 50BV30: 1/2" (12.7 mm): (250 mm); CrV 50BV30: 3/8" (9.5 mm) x 5/16" (7.9 mm); CrV 50BV30: 1/2" (12.7 mm) x 3/8" (9.5 mm); 3/8" (9.5 mm) x 1/4" (6.3 mm); CrV 50BV30: 1/4" (6.3 mm) x 1/4" (6.3 mm); CrV 50BV30: 3/8" (9.5 mm): 5.5, 6.5 mm (L=70 mm); AISI S2: 3/8" (9.5 mm): PH1, PH2, PH3 (L=70 mm); AISI S2: 3/8" (9.5 mm): T20, T30, T40, T45, T50, T55 (L=70 mm); AISI S2: 3/8" (9.5 mm): 6, 7, 8, 10, 12 mm (L=70 mm); AISI S2: 1/4" (6.3 mm): PZ1, PZ2 (L=25 mm); AISI S2: 1/4" (6.3 mm): T8, T10 (L=25 mm); AISI S2: 1/4" (6.3 mm): 4.0, 5.5, 6.5 mm (L=37 mm); AISI S2 / CrV 6150: 1/4" (6.3 mm): PH1, PH2 (L=37 mm); AISI S2 / CrV 6150: 1/4" (6.3 mm): T8, T10, T15, T20, T25, T30, T40 (L=37 mm); AISI S2 / CrV 6150: 1/4" (6.3 mm): 3, 4, 5, 6 mm (L=37 mm); AISI S2 / CrV 6150: 8, 10, 12, 13, 14, 15, 16, 17, 18, 19 mm; CrV: 1.5, 2, 2.5 mm; CrV 6150

YATO	1/2" (12.7 mm)	3/8" (9.5 mm)	1/4" (6.3 mm)	2
YT-38872	1/2" (12.7 mm)	3/8" (9.5 mm)	1/4" (6.3 mm)	2



129
PCS

BMC & COLOR
SLEEVE
XXL SIZE



1/2" (12.7 mm): 12, 13, 14, 15, 16, 17, 18, 19, 20, 21, 22, 24 mm (L=38 mm); 27, 30, 32 mm (L=42 mm); 3/8" (9.5 mm): 10, 11, 12, 13, 14, 15, 16 mm (L=28 mm); 17, 18, 19 mm (L=30 mm); 1/4" (6.3 mm): 4, 4.5, 5, 5.5, 6, 7, 8, 9, 10, 11, 12, 13, 14 mm (L=25 mm); CrV 50BV30: 1/2" (12.7 mm): 10, 12, 13, 14, 17, 19 mm (L=76 mm); 1/4" (6.3 mm): 4, 5, 6, 7, 8, 9 mm (L=50 mm); CrV 50BV30: 1/2" (12.7 mm): 17, 19, 21, 23 mm; CrV 50BV30: 3/8" (9.5 mm): E8, E10, E11, E12, E14, E16, E18, E20; CrV 6150: 1/2" (12.7 mm): (127, 254 mm); 3/8" (9.5 mm): (76, 152.4 mm); 1/4" (6.3 mm): (50.8 mm); CrV 50BV30: 1/2" (12.7 mm); 3/8" (9.5 mm); 1/4" (6.3 mm); CrV 50BV30: 3/8" (9.5 mm): 16, 21 mm; CrV 50BV30: 1/2" (12.7 mm): (255 mm); 3/8" (9.5 mm): (200 mm); 1/4" (6.3 mm): (155 mm); 72T; CrMo 440: 1/4" (6.3 mm): (150 mm); CrV 50BV30: 3/8" (9.5 mm): 4, 5.5, 6.5 mm (L=50 mm); AISI S2 / CrV 6150: 3/8" (9.5 mm): PH1, PH2, PH3 (L=50 mm); AISI S2 / CrV 6150: 3/8" (9.5 mm): PZ1, PZ2, PZ3 (L=50 mm); AISI S2 / CrV 6150: 3/8" (9.5 mm): T20, T30, T40, T45, T50, T55, T60 (L=50 mm); AISI S2 / CrV 6150: 3/8" (9.5 mm): 3, 4, 5, 6, 8, 10 mm (L=50 mm); AISI S2 / CrV 6150: 8, 10, 11, 12, 13, 14, 15, 16, 17, 18, 19, 22 mm; CrV: 3x75, 4x100, 6x150, PH1x75, PH2x100, PH3x150 mm; S2: 160 mm; 160 mm; 160 mm; 1.5, 2, 2.5, 3, 4, 5, 6, 7, 8, 10 mm; CrV 6150

YATO	1/2" (12.7 mm)	3/8" (9.5 mm)	1/4" (6.3 mm)	2
YT-38881	1/2" (12.7 mm)	3/8" (9.5 mm)	1/4" (6.3 mm)	2

GB Tool set
D Sechskant-Steckschlüssel-Satz
PL Zestaw narzędziowy
RUS Набор инструмента

CZ Sada nástrčných klíčů a ráčny
H Dugókulcs készlet racsnis hajtókarral
RO Rotruasa chei tubulare cu antrenor
F Coffret d'outillage

I Set di utensili
E Juego de herramientas
CN 套筒扳手组套

1/2" 12.5mm	3/8" 10mm	1/4" 6.3mm	CrV 50BV30	CrV 6150
CrMo 440	S2	72T	AS-DRIVE	

2



150 PCS METRIC & S.A.E. CrV 6140

BMC & COLOR SLEEVE XXL SIZE



1/2" (12.7 mm): 20, 21, 22, 24 mm (L=38 mm); 27, 30, 32 mm (L=42 mm); 3/8" (9.5 mm): 9, 10, 11, 12, 13, 14, 15, 16 mm (L=28 mm); 17, 18, 19 mm (L=30 mm); 1/4" (6.3 mm): 4, 5, 6, 7, 8, 9, 10, 11, 12, 13 mm (L=25 mm); CrV 50BV30: 1/2" (12.7 mm): 10, 12, 13, 14, 17, 19 mm (L=76 mm); 3/8" (9.5 mm): 10, 11, 12, 13, 14, 15 mm (L=63 mm); 1/4" (6.3 mm): 4, 5, 6, 7, 8, 9 mm (L=50 mm); CrV 50BV30: 1/2" (12.7 mm) x 15/16" (23.8 mm); 1/2" (12.7 mm) x 1" (25.4 mm); 1/2" (12.7 mm) x 1-1/16" (27.0 mm); 1/2" (12.7 mm) x 1-1/4" (31.8 mm); 3/8" (9.5 mm) x 3/8" (9.5 mm); 3/8" (9.5 mm) x 7/16" (11.1 mm); 3/8" (9.5 mm) x 1/2" (12.7 mm); 3/8" (9.5 mm) x 9/16" (14.3 mm); 3/8" (9.5 mm) x 5/8" (15.9 mm); 3/8" (9.5 mm) x 11/16" (17.5 mm); 3/8" (9.5 mm) x 3/4" (19.0 mm); 3/8" (9.5 mm) x 13/16" (20.6 mm); 3/8" (9.5 mm) x 7/8" (22.2 mm); 1/4" (6.3 mm) x 5/32" (4.0 mm); 1/4" (6.3 mm) x 3/16" (4.8 mm); 1/4" (6.3 mm) x 7/32" (5.6 mm); 1/4" (6.3 mm) x 1/4" (6.3 mm); 1/4" (6.3 mm) x 9/32" (7.1 mm); 1/4" (6.3 mm) x 5/16" (7.9 mm); 1/4" (6.3 mm) x 11/32" (8.7 mm); 1/4" (6.3 mm) x 3/8" (9.5 mm); 1/4" (6.3 mm) x 7/16" (11.1 mm); 1/4" (6.3 mm) x 1/2" (12.7 mm); CrV 50BV30: 1/2" (12.7 mm): 17, 19, 21, 23 mm; CrV 50BV30: 3/8" (9.5 mm): E8, E10, E11, E12, E14, E16, E18, E20; CrV 6150: 1/2" (12.7 mm): (127, 254 mm); 3/8" (9.5 mm): (76, 152.4 mm); 1/4" (6.3 mm): (50.8 mm); CrV 50BV30: 1/2" (12.7 mm); 3/8" (9.5 mm); 1/4" (6.3 mm); CrV 50BV30: 3/8" (9.5 mm): 16, 21 mm; CrV 50BV30: 1/2" (12.7 mm): (255 mm); 3/8" (9.5 mm): (200 mm); 1/4" (6.3 mm): (155 mm); 72T; CrMo 440: 1/4" (6.3 mm); (150 mm); CrV 50BV30: 1/4" (6.3 mm) x 1/4" (6.3 mm); CrV 50BV30: 1/4" (6.3 mm): T10, T15, T20, T25, T27, T30, T40 (L=25 mm); AISI S2: 3/8" (9.5 mm): 4, 5.5, 6.5 mm (L=50 mm); AISI S2 / CrV 6150: 3/8" (9.5 mm): PH1, PH2, PH3 (L=50 mm); AISI S2 / CrV 6150: 3/8" (9.5 mm): PZ1, PZ2, PZ3 (L=50 mm); AISI S2 / CrV 6150: 3/8" (9.5 mm): T20, T30, T40, T45, T50, T55, T60 (L=50 mm); AISI S2 / CrV 6150: 3/8" (9.5 mm): 3, 4, 5, 6, 8, 10 mm (L=50 mm); AISI S2 / CrV 6150: 8, 9, 10, 11, 12, 13, 14, 15, 16, 17, 18, 19 mm; CrV: 8x10, 12x13, 17x19 mm; CrV 6140: 1.5, 2, 2.5, 3, 4, 5, 6, 7, 8, 10 mm; CrV 6150

YATO	1/2" (12.7 mm)	3/8" (9.5 mm)	1/4" (6.3 mm)	2
YT-38811				

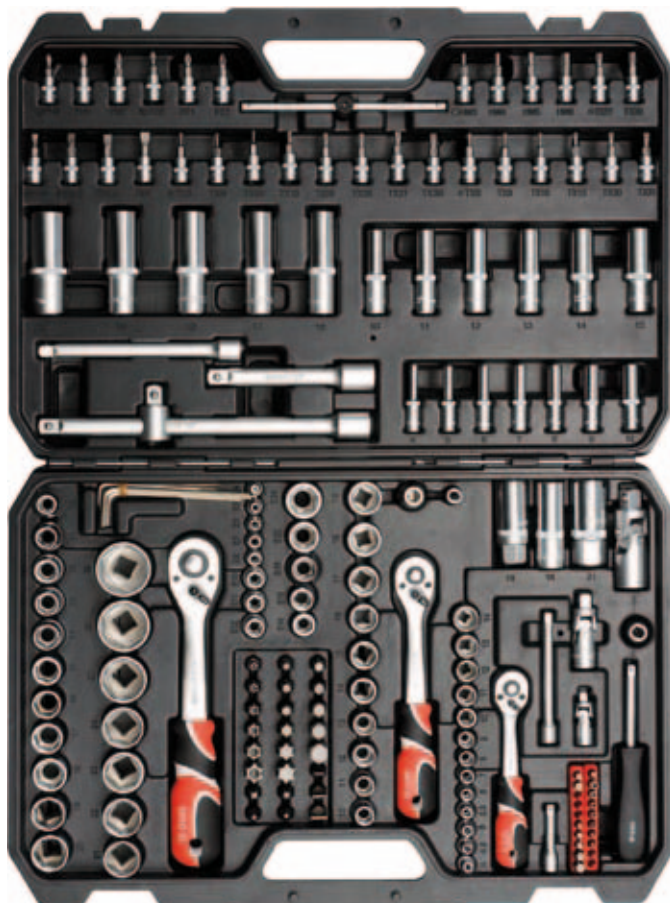

173 PCS CrV 40

BMC & COLOR SLEEVE XL SIZE



1/2" (12.7 mm): 10, 11, 12, 13, 14, 15, 16, 17, 18, 19, 20, 21, 22, 23, 24 mm (L=38 mm); 27, 30, 32 mm (L=42 mm); 3/8" (9.5 mm): 10, 11, 12, 13, 14, 15, 16 mm (L=28 mm); 17, 18, 19 mm (L=30 mm); 1/4" (6.3 mm): 4, 4.5, 5, 5.5, 6, 7, 8, 9, 10, 11, 12, 13, 14 mm (L=25 mm); CrV 50BV30: 1/2" (12.7 mm): 16, 17, 18, 19, 22 mm (L=76 mm); 3/8" (9.5 mm): 10, 11, 12, 13, 14, 15 mm (L=63 mm); 1/4" (6.3 mm): 4, 5, 6, 7, 8, 9, 10 mm (L=50 mm); CrV 50BV30: 1/2" (12.7 mm): E18, E20, E24; 3/8" (9.5 mm): E10, E11, E12, E14, E16, 1/4" (6.3 mm): E4, E5, E6, E7, E8; CrV 6150: 1/2" (12.7 mm): (127, 254 mm); 3/8" (9.5 mm): (152.4 mm); 1/4" (6.3 mm): (50.8, 101.6 mm); CrV 50BV30: 3/8" (9.5 mm) (F) x 1/2" (12.7 mm); CrV 50BV30: 1/2" (12.7 mm); 3/8" (9.5 mm); 1/4" (6.3 mm); CrV 50BV30: 1/2" (12.7 mm): 16, 21 mm; 3/8" (9.5 mm); 18 mm; CrV 50BV30: 1/4" (6.3 mm); (152.4 mm); CrV 40: 1/2" (12.7 mm); (255 mm); 3/8" (9.5 mm); (200 mm); 1/4" (6.3 mm); (155 mm); 72T; CrMo 440: 1/4" (6.3 mm); (150 mm); CrV 50BV30: 1/2" (12.7 mm) x 5/16" (7.9 mm); 3/8" (9.5 mm) x 5/16" (7.9 mm); CrV 50BV30: 1/4" (6.3 mm) x 1/4" (6.3 mm); CrV 50BV30: 5/16" (7.9 mm): 8, 10, 12 mm (L=30 mm); AISI S2: 5/16" (7.9 mm): PH3, PH4 (L=30 mm); AISI S2: 5/16" (7.9 mm): PZ3, PZ4 (L=30 mm); AISI S2: 5/16" (7.9 mm): T40, T45, T50, T55, T60, T70 (L=30 mm); AISI S2: 5/16" (7.9 mm): T40, T45, T50, T55, T60, T70 (L=30 mm); AISI S2: 5/16" (7.9 mm): 7, 8, 10, 12, 14 mm (L=30 mm); AISI S2: 1/4" (6.3 mm): T5, T6, T7 (L=25 mm); AISI S2: 1/4" (6.3 mm): T7, T10, T15, T20, T25, T27, T30, T40, T45 (L=25 mm); AISI S2: 1/4" (6.3 mm): M5, M6, M8 (L=25 mm); AISI S2: 1/4" (6.3 mm): RM5, RM6, RM7, RM8, RM9 (L=25 mm); AISI S2: 1/4" (6.3 mm): 4, 5, 5.5, 6.5, 7 mm (L=37 mm); AISI S2 / CrV 6150: 1/4" (6.3 mm): PH0, PH1, PH2 (L=37 mm); AISI S2 / CrV 6150: 1/4" (6.3 mm): PZ0, PZ1, PZ2 (L=37 mm); AISI S2 / CrV 6150: 1/4" (6.3 mm): T8, T9, T10, T15, T20, T25, T27, T30 (L=37 mm); AISI S2 / CrV 6150: 1/4" (6.3 mm): T8, T9, T10, T15, T20, T25, T27, T30 (L=37 mm); AISI S2 / CrV 6150: 1/4" (6.3 mm): 3, 4, 5, 6 mm (L=37 mm); AISI S2 / CrV 6150: 1.25, 1.5, 2, 2.5, 3, 4, 5 mm; CrV 6150

YATO	1/2" (12.7 mm)	3/8" (9.5 mm)	1/4" (6.3 mm)	2
YT-38931				



- GB Socket set
- D Sechskant-Steckschlüssel-Satz
- PL Komplet nasadek długich
- RUS Набор насадок
- CZ Sada nástrčných klíčů
- H Dugókulcs készlet
- RO Trusă chei tubulare
- F Set de douilles longues
- I Serie di chiavi a bussola lunghi
- E Juego de herramientas
- CN 长套筒组套

8 PCS	1/4" 6.3mm	CrV 50BV30	AS-DRIVE
----------	---------------	---------------	----------



1/4" (6.3 mm): 5.5, 6, 7, 8, 9, 10, 12, 13 mm
(L=50 mm); CrV 50BV30



YATO	○	
YT-1443	1/4" (6.3 mm)	10

- GB Tool set
- D Sechskant-Steckschlüssel-Satz
- PL Zestaw narzędziowy
- RUS Набор инструмента
- CZ Sada nástrčných klíčů a ráčny
- H Dugókulcs készlet racsnis hajtókkal
- RO Rotrusa chei tubulare cu antrenor
- F Coffret d'outillage
- I Set di utensili
- E Juego de herramientas
- CN 套筒扳手组套

METAL CASE & COLOR SLEEVE

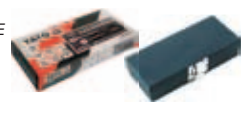

1/4" 6.3mm	CrV 50BV30	CrV 6140
72T	AS-DRIVE	

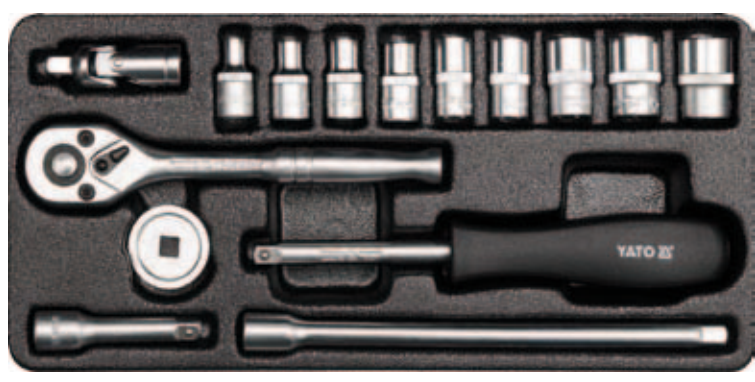

15
PCS

1/4" (6.3 mm): 4, 5, 6, 7, 8, 9, 10, 12, 13 mm (L=25 mm); CrV 50BV30;
1/4" (6.3 mm): (50.8, 152.4 mm); CrV 50BV30;
1/4" (6.3 mm); CrV 50BV30;
1/4" (6.3 mm): (127 mm); 72T; CrV 6140;
1/4" (6.3 mm): (150 mm); CrV 50BV30;

YATO	○	
YT-1441	1/4" (6.3 mm)	10



23
PCS

1/4" (6.3 mm): 4, 5, 6, 7, 8, 9, 10, 12, 13 mm (L=25 mm); CrV 50BV30;
1/4" (6.3 mm): 4, 5, 6, 7, 8, 9, 10, 12, 13 mm (L=50 mm); CrV 50BV30;
1/4" (6.3 mm): (50.8, 152.4 mm); CrV 50BV30;
1/4" (6.3 mm); CrV 50BV30;
1/4" (6.3 mm): (127 mm); 72T; CrV 6140;
1/4" (6.3 mm): (150 mm); CrV 50BV30

YATO	○	
YT-1442	1/4" (6.3 mm)	10

GB Tool set
 D Sechskant-Steckschlüssel-Satz
 PL Zestaw narzędziowy
 RUS Набор инструмента
 CZ Sada nástrčných kľučí a ráčny
 H Dugókulcs készlet racsnis hajtókarral

RO Rotrușă de tubulare cu antrenor
 F Coffret d'outillage
 I Set di utensili
 E Juego de herramientas
 CN 套筒扳手组套

BMC & COLOR SLEEVE
 XS SIZE









1/4" 6.3mm	CrV 50BV30	CrV 6140
72T	AS-DRIVE	

2









15
PCS



 1/4" (6.3 mm): 4, 5, 6, 7, 8, 9, 10, 12, 13 mm (L=25 mm); CrV 50BV30;
 1/4" (6.3 mm); (50.8, 152.4 mm); CrV 50BV30;
 1/4" (6.3 mm); CrV 50BV30;
 1/4" (6.3 mm); (155 mm); 72T; CrV 6140;
 1/4" (6.3 mm); (150 mm); CrV 50BV30; 

YATO 		
YT-1444	1/4" (6.3 mm)	10









20
PCS



 1/4" (6.3 mm): 3.5, 4, 4.5, 5, 5.5, 6, 7, 8, 9, 10, 11, 12, 13, 14 mm (L=25 mm); CrV 50BV30;
 1/4" (6.3 mm); (50.8, 152.4 mm); CrV 50BV30;
 1/4" (6.3 mm); CrV 50BV30;
 1/4" (6.3 mm); (152.4 mm); CrV 50BV30;
 1/4" (6.3 mm); (155 mm); 72T; CrV 6140;
 1/4" (6.3 mm); (150 mm); CrV 50BV30

YATO 		
YT-1449	1/4" (6.3 mm)	10



23
PCS

 1/4" (6.3 mm): 4, 5, 6, 7, 8, 9, 10, 12, 13 mm (L=25 mm); CrV 50BV30;
 1/4" (6.3 mm): 4, 5, 6, 7, 8, 9, 10, 12, 13 mm (L=50 mm); CrV 50BV30;
 1/4" (6.3 mm); (50.8, 152.4 mm); CrV 50BV30;
 1/4" (6.3 mm); CrV 50BV30;
 1/4" (6.3 mm); (155 mm); 72T; CrV 6140;
 1/4" (6.3 mm); (150 mm); CrV 50BV30

YATO 		
YT-1445	1/4" (6.3 mm)	10

GB Tool set
D Sechskant-Steckschlüssel-Satz
PL Zestaw narzędziowy
RUS Набор инструмента
CZ Sada nástrčných klíčů a ráčny
H Dugókulcs készlet racsnis hajtókkal

RO Rotrusa chei tubulare cu antrenor
F Coffret d'outillage
I Set di utensili
E Juego de herramientas
CN 套筒扳手组套

BMC & COLOR SLEEVE
XS SIZE



1/4"
6.3mm

CrV
50BV30

CrV
6140

72T

AS-DRIVE

2

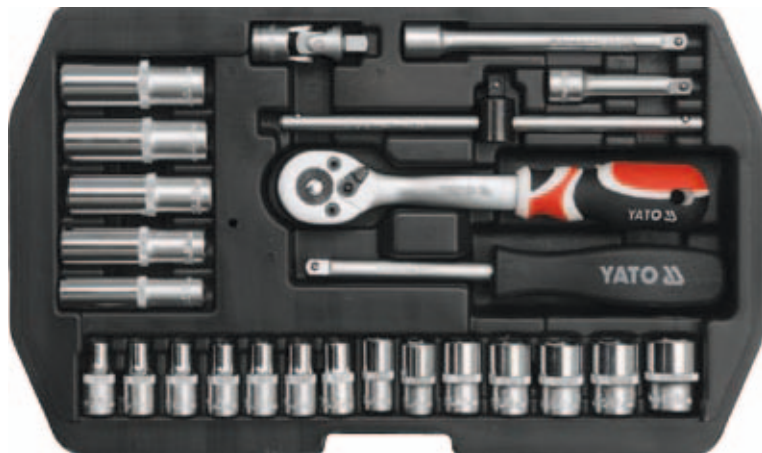

25
PCS

- 1/4" (6.3 mm): 3.5, 4, 4.5, 5, 5.5, 6, 7, 8, 9, 10, 11, 12, 13, 14 mm (L=25 mm); CrV 50BV30;
- 1/4" (6.3 mm): 8, 10, 11, 12, 13 mm (L=50 mm); CrV 50BV30;
- 1/4" (6.3 mm): (50.8, 101.6 mm); CrV 50BV30;
- 1/4" (6.3 mm): CrV 50BV30;
- 1/4" (6.3 mm): (152.4 mm); CrV 50BV30;
- 1/4" (6.3 mm): (155 mm); 72T; CrV 6140;
- 1/4" (6.3 mm): (150 mm); CrV 50BV30

YATO		
YT-1446	1/4" (6.3 mm)	10



38
PCS

CrV
6150

S2

- 1/4" (6.3 mm): 3.5, 4, 4.5, 5, 5.5, 6, 7, 8, 9, 10, 11, 12, 13, 14 mm (L=25 mm); CrV 50BV30;
- 1/4" (6.3 mm): (50.8, 101.6 mm); CrV 50BV30;
- 1/4" (6.3 mm): (152.4 mm); CrV 50BV30;
- 1/4" (6.3 mm): (155 mm); 72T; CrV 6140;
- 1/4" (6.3 mm): (150 mm); CrV 50BV30;
- 1/4" (6.3 mm): PH1, PH2 (L=37 mm); AISI S2 / CrV 6150;
- 1/4" (6.3 mm): PZ1, PZ2 (L=37 mm); AISI S2 / CrV 6150;
- 1/4" (6.3 mm): T10, T15, T20, T25, T30, T40 (L=37 mm); AISI S2 / CrV 6150;
- 1/4" (6.3 mm): 3, 4, 5, 6, 8 mm (L=37 mm); AISI S2 / CrV 6150

YATO		
YT-1447	1/4" (6.3 mm)	10



42
PCS

CrV
6150

S2

- 1/4" (6.3 mm): 4, 4.5, 5, 5.5, 6, 7, 8, 9, 10, 11, 12, 13, 14 mm (L=25 mm); CrV 50BV30;
- 1/4" (6.3 mm): 8, 9, 10, 11, 12, 13 mm (L=50 mm); CrV 50BV30;
- 1/4" (6.3 mm): (50.8, 101.6 mm); CrV 50BV30;
- 1/4" (6.3 mm): (150 mm); CrV 6140;
- 1/4" (6.3 mm): (152.4 mm); CrV 50BV30;
- 1/4" (6.3 mm): (155 mm); 72T; CrV 6140;
- 1/4" (6.3 mm): (150 mm); CrV 50BV30;
- 1/4" (6.3 mm) x 1/4" (6.3 mm); CrV 6140;
- 1/4" (6.3 mm): 3, 4, 5 mm (L=25 mm); AISI S2;
- 1/4" (6.3 mm): PH0, PH1, PH2 (L=25 mm); AISI S2;
- 1/4" (6.3 mm): PZ0, PZ1, PZ2 (L=25 mm); AISI S2;
- 1/4" (6.3 mm): 6, 7, 8 mm (L=25 mm); AISI S2;
- 1.5, 2, 2.5 mm; CrV 6150

YATO		
YT-1448	1/4" (6.3 mm)	6

GB Tool set
 D Sechskant-Steckschlüssel-Satz
 PL Zestaw narzędziowy
 RUS Набор инструмента
 CZ Sada nástrčných klíčů a ráčny
 H Dugókulcs készlet racsnis hajtókarral

RO Rotrușă de chei tubulare cu antrenor
 F Coffret d'outillage
 I Set di utensili
 E Juego de herramientas
 CN 套筒扳手组套

BMC & COLOR SLEEVE
 XS SIZE



56 PCS	1/4" 6.3mm	CrV 50BV30
	CrV 6150	CrV 6140
	S2	72T
		AS-DRIVE

2



1/4" (6.3 mm): 4, 4.5, 5, 5.5, 6, 7, 8, 9, 10, 11, 12, 13 mm (L=25 mm); CrV 50BV30;
 1/4" (6.3 mm): 6, 7, 8, 9, 10, 11, 12, 13 mm (L=50 mm); CrV 50BV30; 1/4" (6.3 mm): E4, E5, E6, E7, E8, E10; CrV 50BV30; 1/4" (6.3 mm): (76, 152.4 mm); CrV 50BV30; 1/4" (6.3 mm): (150 mm); CrV 6140; 1/4" (6.3 mm); CrV 50BV30; 1/4" (6.3 mm): (152.4 mm); CrV 50BV30;
 1/4" (6.3 mm): (155 mm); 72T; CrV 6140; 1/4" (6.3 mm): (150 mm); CrV 50BV30; 1/4" (6.3 mm) (F) x 3/8" (9.5 mm) (M); CrV 50BV30;
 1/4" (6.3 mm): 4, 5.5, 6.5 mm (L=37 mm); AISI S2 / CrV 6150; 1/4" (6.3 mm): PH1, PH2, PH3 (L=37 mm); AISI S2 / CrV 6150; 1/4" (6.3 mm): PZ1, PZ2, PZ3 (L=37 mm); AISI S2 / CrV 6150; 1/4" (6.3 mm): T8, T10, T15, T20, T25, T30, T40 (L=37 mm); AISI S2 / CrV 6150; 1/4" (6.3 mm): 3, 4, 5, 6, 7, 8 mm (L=37 mm); AISI S2 / CrV 6150

YATO		
YT-1450	1/4" (6.3 mm)	10

GB Socket set
 D Sechskant-Steckschlüssel-Satz
 PL Komplet nasadek dlugich
 RUS Набор насадок

CZ Sada nástrčných klíčů
 H Dugókulcs készlet
 RO Trusă chei tubulare
 F Set de douilles longues

I Serie di chiavi a bussola lunghi
 E Juego de herramientas
 CN 长套筒组套

9 PCS
 3/8" 10mm
 CrV 50BV30
 AS-DRIVE



PLASTIC HANGER



3/8" (9.5 mm): 8, 10, 11, 12, 13, 14, 16, 17, 19 mm (L=63 mm); CrV 50BV30

YATO	3/8" (9.5 mm)	10
YT-3855		

GB Tool set
 D Sechskant-Steckschlüssel-Satz
 PL Zestaw narzędziowy
 RUS Набор инструмента

CZ Sada nástrčných klíčů a ráčny
 H Dugókulcs készlet racsnis hajtókarral
 RO Rotrusa chei tubulare cu antrenor
 F Coffret d'outillage

I Set di utensili
 E Juego de herramientas
 CN 套筒扳手组套



METAL CASE & COLOR SLEEVE

3/8" 10mm
 CrV 50BV30
 CrV 6140
 72T
 AS-DRIVE



15 PCS

3/8" (9.5 mm): 10, 11, 12, 13, 14, 15 (L=28 mm); 17, 19, 21, 22 mm (L=30 mm); CrV 50BV30;
 3/8" (9.5 mm): (76, 152.4 mm); CrV 50BV30;
 3/8" (9.5 mm): 16, 21 mm; CrV 50BV30;
 3/8" (9.5 mm): (200 mm); 72T; CrV 6140

YATO	3/8" (9.5 mm)	10
YT-38631		

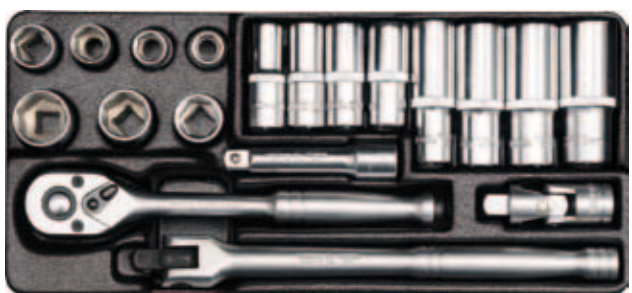

19 PCS

3/8" (9.5 mm): 10, 11, 13, 14, 15 (L=28 mm); 17, 19 mm (L=30 mm); CrV 50BV30;
 3/8" (9.5 mm): 10, 11, 12, 13 mm (L=46 mm); 14, 15, 17, 19 mm (L=63 mm); CrV 50BV30;
 3/8" (9.5 mm): (76 mm); CrV 50BV30; 3/8" (9.5 mm); CrV 50BV30;
 3/8" (9.5 mm): (200 mm); 72T; CrV 6140;
 3/8" (9.5 mm): (215 mm); CrV 50BV30

YATO	3/8" (9.5 mm)	8
YT-38641		

GB Tool set
 D Sechskant-Steckschlüssel-Satz
 PL Zestaw narzędziowy
 RUS Набор инструмента
 CZ Sada nástrčných klíčů a ráčny
 H Dugókulcs készlet racsnis hajtókarral

RO Rotrusa chei tubulare cu antrenor
 F Coffret d'outillage
 I Set di utensili
 E Juego de herramientas
 CN 套筒扳手组套

BMC & COLOR SLEEVE
 XS SIZE



22 PCS
 3/8" 10mm
 CrV 50BV30
 CrV 6140
 72T
 AS-DRIVE



3/8" (9.5 mm): 6, 7, 8, 9, 10, 11, 12, 13, 14, 15, 16 mm (L=28 mm); 17, 18, 19, 20, 21, 22 mm (L=30 mm); CrV 50BV30;
 3/8" (9.5 mm): (76, 152.4 mm); CrV 50BV30;
 3/8" (9.5 mm); CrV 50BV30;
 3/8" (9.5 mm): (198 mm); CrV 50BV30;
 3/8" (9.5 mm): (200 mm); 72T; CrV 6140

YATO	3/8" (9.5 mm)	10
YT-3856		

GB Tool set
 D Sechskant-Steckschlüssel-Satz
 PL Zestaw narzędziowy
 RUS Набор инструмента
 CZ Sada nástrčných klíčů a ráčny
 H Dugókulcs készlet racsnis hajtókarral













RO Rotrușă de chei tubulare cu antrenor
 F Coffret d'outillage
 I Set di utensili
 E Juego de herramientas
 CN 套筒扳手组套



BMC & COLOR SLEEVE
 M SIZE



58 PCS	3/8" 10 mm	CrV 50BV30
	CrV 6150	CrV 6140
	S2	72T
		AS-DRIVE



 3/8" (9.5 mm): 6, 7, 8, 9, 10, 11, 12, 13, 14, 15, 16 mm (L=28 mm); 17, 18, 19, 20, 21, 22, 24 mm (L=30 mm); CrV 50BV30:  3/8" (9.5 mm): 8, 10, 11, 12, 13, 14, 15, 17, 19 mm (L=63 mm); CrV 50BV30:  3/8" (9.5 mm): (76, 254 mm); CrV 50BV30:  3/8" (9.5 mm): CrV 50BV30:  3/8" (9.5 mm): 16, 21 mm; CrV 50BV30:  3/8" (9.5 mm): (200 mm); 72T; CrV 6140:  1/2" (12.7 mm) (F) x 3/8" (9.5 mm) (M); CrV 50BV30:  3/8" (9.5 mm): 5.5, 6.5, 8 mm (L=50 mm); AISI S2 / CrV 6150:  3/8" (9.5 mm): PH1, PH2, PH3 (L=50 mm); AISI S2 / CrV 6150:  3/8" (9.5 mm): PZ1, PZ2 (L=50 mm); AISI S2 / CrV 6150:  3/8" (9.5 mm): T10, T15, T20, T25, T30, T40, T45, T50, T55 (L=50 mm); AISI S2 / CrV 6150:  3/8" (9.5 mm): 3, 4, 5, 6, 7, 8, 10 mm (L=50 mm); AISI S2 / CrV 6150

YATO 		
YT-3857	3/8" (9.5 mm)	6

GB Socket set
D Sechskant-Steckschlüssel-Satz
PL Komplet nasadek dlugich
RUS Набор насадок

CZ Sada nástrčných klíčů
H Dugókulcs készlet
RO Trusă chei tubulare
F Set de douilles longues

I Serie di chiavi a bussola lunghi
E Juego de herramientas
CN 长套筒组套

10
PCS

1/2"
12.5mm

CrV
50BV30

AS-DRIVE



1/2" (12.7 mm): 10, 12, 13, 14, 15, 17, 19, 21, 22, 24 mm (L=76 mm); CrV 50BV30

PLASTIC HANGER



YATO		
YT-3886	1/2" (12.7 mm)	10

GB Ratchet handle with socket set
D Sechskant-Steckschlüssel-Satz
PL Komplet nasadek z grzechotką
RUS Набор насадок

CZ Sada nástrčných klíčů a ráčny
H Dugókulcs készlet racsnis hajtókarral
RO Rotrusa chei tubulare cu antrenor
F Clé mixte à cliquet + douilles

I Serie di chiavi con cricchetto
E Matraca con boquillas
CN 套筒扳手组套

PLASTIC HANGER



12
PCS

1/2"
12.5mm

CrV
50BV30

CrV
6140

72T

AS-DRIVE



1/2" (12.7 mm): 10, 11, 12, 13, 14, 15, 17, 19, 21, 24 mm (L=38 mm); CrV 50BV30;
1/2" (12.7 mm): (127 mm); CrV 50BV30;
1/2" (12.7 mm): (255 mm); 72T; CrV 6140

YATO		
YT-3882	1/2" (12.7 mm)	10

GB Ratchet handle with socket set
D Sechskant-Steckschlüssel-Satz
PL Komplet nasadek z grzechotką
RUS Набор насадок

CZ Sada nástrčných klíčů a ráčny
H Dugókulcs készlet racsnis hajtókarral
RO Rotrusa chei tubulare cu antrenor
F Clé mixte à cliquet + douilles

I Serie di chiavi con cricchetto
E Matraca con boquillas
CN 套筒扳手组套

PLASTIC HANGER



19
PCS

1/2"
12.5mm

CrV
50BV30

CrV
6140

72T

AS-DRIVE



1/2" (12.7 mm): 8, 9, 10, 11, 12, 13, 14, 15, 16, 17, 19, 21, 22, 23, 24 mm (L=38 mm);
27, 30, 32 mm (L=42 mm); CrV 50BV30;
1/2" (12.7 mm): (255 mm); 72T; CrV 6140

YATO		
YT-3868	1/2" (12.7 mm)	6

GB Ratchet handle with socket set
D Sechskant-Steckschlüssel-Satz
PL Komplet nasadek z grzechotką
RUS Набор насадок

CZ Sada nástrčných klíčů a ráčny
H Dugókulcs készlet racsnis hajtókarral
RO Rotrusa chei tubulare cu antrenor
F Clé mixte à cliquet + douilles

I Serie di chiavi con cricchetto
E Matraca con boquillas
CN 套筒扳手组套

PLASTIC HANGER



19
PCS

1/2"
12.5mm

12 pt

CrV
50BV30

CrV
6140

72T

AS-DRIVE



1/2" (12.7 mm): 8, 9, 10, 11, 12, 13, 14, 15, 16, 17, 19, 21, 22, 23, 24 mm (L=38 mm);
27, 30, 32 mm (L=42 mm); CrV 50BV30;
1/2" (12.7 mm): (255 mm); 72T; CrV 6140

YATO		
YT-38682	1/2" (12.7 mm)	6

GB Tool set
D Sechskant-Steckschlüssel-Satz
PL Zestaw narzędziowy
RUS Набор инструмента

CZ Sada nástrčných klíčů a ráčny
H Dugókulcs készlet racsnis hajtókarral
RO Rotrusa chei tubulare cu antrenor
F Coffret d'outillage

I Set di utensili
E Juego de herramientas
CN 套筒扳手组套



METAL CASE & COLOR SLEEVE

12
PCS

1/2"
12.5mm

CrV
50BV30

CrV
6140

72T

AS-DRIVE

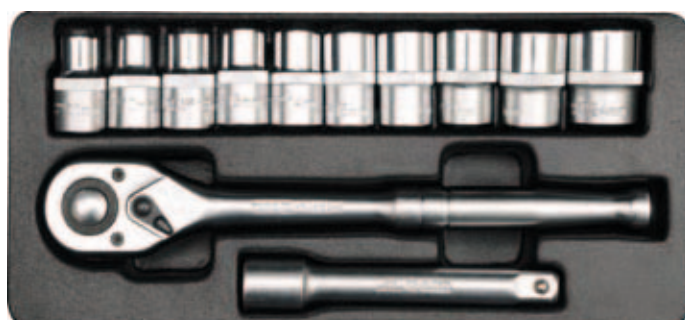

1/2" (12.7 mm): 10, 11, 12, 13, 14, 15, 17, 19, 21, 24 mm (L=38 mm); CrV 50BV30;
1/2" (12.7 mm): (125 mm); CrV 50BV30;
1/2" (12.7 mm): (250 mm); 72T; CrV 6140

YATO		
YT-12621	1/2" (12.7 mm)	8

GB Tool set
D Sechskant-Steckschlüssel-Satz
PL Zestaw narzędziowy
RUS Набор инструмента

CZ Sada nástrčných kľúčů a ráčny
H Dugókulcs készlet racsnis hajtókarral
RO Rotrusa chei tubulare cu antrenor
F Coffret d'outillage

I Set di utensili
E Juego de herramientas
CN 套筒扳手组套



1/2"
12.5mm
CrV
50BV30
CrV
6140
72T
AS-DRIVE

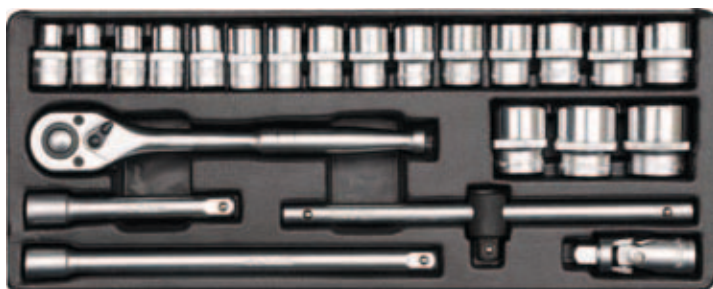

23
PCS

1/2" (12.7 mm): 10, 11, 12, 13, 14, 15, 16, 17, 18, 19, 20, 21, 22, 23, 24 mm (L=38 mm); 27, 30, 32 mm (L=42 mm); CrV 50BV30;
1/2" (12.7 mm): (125, 250 mm); CrV 50BV30;
1/2" (12.7 mm); CrV 50BV30;
1/2" (12.7 mm); (250 mm); CrV 50BV30;
1/2" (12.7 mm); (250 mm); 72T; CrV 6140

YATO	○	
YT-12651	1/2" (12.7 mm)	5



25
PCS

1/2" (12.7 mm): 10, 11, 12, 13, 14, 15, 16, 17, 18, 19, 20, 21, 22, 23, 24 mm (L=38 mm); 27, 30, 32 mm (L=42 mm); CrV 50BV30;
1/2" (12.7 mm); (50, 125 mm); CrV 50BV30;
1/2" (12.7 mm): 16, 21 mm; CrV 50BV30;
1/2" (12.7 mm); (250 mm); CrV 50BV30;
1/2" (12.7 mm); (250 mm); 72T; CrV 6140;
1/2" (12.7 mm); (317 mm); CrV 50BV30

YATO	○	
YT-12671	1/2" (12.7 mm)	5

GB Tool set
D Sechskant-Steckschlüssel-Satz
PL Zestaw narzędziowy
RUS Набор инструмента

CZ Sada nástrčných kľúčů a ráčny
H Dugókulcs készlet racsnis hajtókarral
RO Rotrusa chei tubulare cu antrenor
F Coffret d'outillage

I Set di utensili
E Juego de herramientas
CN 套筒扳手组套

1/2"
12.5mm
CrV
50BV30
CrV
6140
72T
AS-DRIVE



18
PCS

1/2" (12.7 mm): 11, 13, 14, 15, 17, 19, 21, 22, 23, 24 mm (L=38 mm); 27, 30, 32 mm (L=42 mm); CrV 50BV30;
1/2" (12.7 mm); (127 mm); CrV 50BV30;
1/2" (12.7 mm): 16, 21 mm; CrV 50BV30;
1/2" (12.7 mm); (255 mm); 72T; CrV 6140;
1/2" (12.7 mm); (457 mm); CrV 50BV30



YATO	○	
YT-3870	1/2" (12.7 mm)	6



20
PCS

1/2" (12.7 mm): 10, 11, 12, 13, 14, 15, 16, 17, 18, 19, 22, 24 mm (L=38 mm); CrV 50BV30;
1/2" (12.7 mm): 13, 17, 19 mm (L=76 mm); CrV 50BV30;
1/2" (12.7 mm): (254 mm); CrV 50BV30;
3/8" (9.5 mm) (F) x 1/2" (12.7 mm) (M); CrV 50BV30;
1/2" (12.7 mm); CrV 50BV30;
1/2" (12.7 mm): 16 mm; CrV 50BV30;
1/2" (12.7 mm); (255 mm); 72T; CrV 6140



YATO	○	
YT-3869	1/2" (12.7 mm)	6

GB Tool set
D Sechskant-Steckschlüssel-Satz
PL Zestaw narzędziowy
RUS Набор инструмента





CZ Sada nástrčných klíčů a ráčny
H Dugókulcs készlet racsnis hajtókarral
RO Rotruşa chei tubulare cu antrenor
F Coffret d'outillage

I Set di utensili
E Juego de herramientas
CN 套筒扳手组套

1/2"
12.5mm
CrV
50BV30
CrV
6140
72T
AS-DRIVE





23
PCS

-  1/2" (12.7 mm): 10, 11, 12, 13, 14, 15, 16, 17, 18, 19, 20, 21, 22, 23, 24 mm (L=38 mm); 27, 30, 32 mm (L=42 mm); CrV 50BV30;
-  1/2" (12.7 mm): (127, 254 mm); CrV 50BV30;
-  1/2" (12.7 mm): CrV 50BV30;
-  1/2" (12.7 mm): (255 mm); CrV 50BV30;
-  1/2" (12.7 mm); (255 mm); 72T; CrV 6140







BMC & COLOR SLEEVE
M SIZE



YATO 		
YT-3873	1/2" (12.7 mm)	6





24
PCS

-  1/2" (12.7 mm): 10, 11, 12, 13, 14, 15, 16, 17, 18, 19, 20, 21, 22, 23, 24 mm (L=38 mm); 27, 30, 32 mm (L=42 mm); CrV 50BV30;
-  1/2" (12.7 mm): (127 mm); CrV 50BV30;
-  1/2" (12.7 mm): CrV 50BV30;
-  1/2" (12.7 mm): 16, 21 mm; CrV 50BV30;
-  1/2" (12.7 mm): (255 mm); CrV 50BV30;
-  1/2" (12.7 mm); (255 mm); 72T; CrV 6140





BMC & COLOR SLEEVE
M SIZE



YATO 		
YT-3872	1/2" (12.7 mm)	6





25
PCS

-  1/2" (12.7 mm): 8, 9, 10, 11, 12, 13, 14, 15, 16, 17, 18, 19, 20, 21, 22, 23, 24 mm (L=38 mm); 27, 30, 32 mm (L=42 mm); CrV 50BV30;
-  1/2" (12.7 mm): (127, 254 mm); CrV 50BV30;
-  3/8" (9.5 mm) (F) x 1/2" (12.7 mm) (M); CrV 50BV30;
-  1/2" (12.7 mm); CrV 50BV30;
-  1/2" (12.7 mm); (255 mm); 72T; CrV 6140





BMC & COLOR SLEEVE
M SIZE

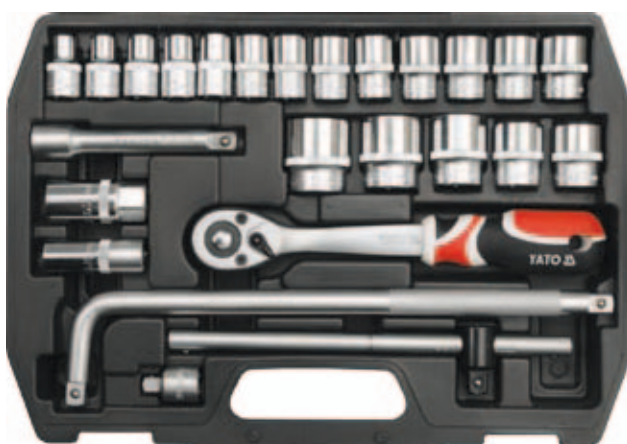

YATO 		
YT-3871	1/2" (12.7 mm)	6





25
PCS

-  1/2" (12.7 mm): 10, 11, 12, 13, 14, 15, 16, 17, 18, 19, 20, 21, 22, 23, 24 mm (L=38 mm); 27, 30, 32 mm (L=42 mm); CrV 50BV30;
-  1/2" (12.7 mm): (127 mm); CrV 50BV30;
-  1/2" (12.7 mm): (255 mm); CrV 50BV30;
-  1/2" (12.7 mm); (255 mm); 72T; CrV 6140;
-  1/2" (12.7 mm) (F) x 3/8" (9.5 mm) (M); CrV 50BV30

BMC & COLOR SLEEVE
L SIZE



YATO 		
YT-3874	1/2" (12.7 mm)	6

GB Tool set
D Sechskant-Steckschlüssel-Satz
PL Zestaw narzędziowy
RUS Набор инструмента

CZ Sada nástrčných klíčů a ráčny
H Dugókulcs készlet racsnis hajtókarral
RO Rotrusa chei tubulare cu antrenor
F Coffret d'outillage

I Set di utensili
E Juego de herramientas
CN 套筒扳手组套

BMC & COLOR SLEEVE
M SIZE



46 PCS	1/2" 12.5mm
METRIC & S.A.E.	CrV 50BV30
CrV 6140	72T
AS-DRIVE	

2



1/2" (12.7 mm): 8, 9, 10, 11, 12, 13, 14, 15, 16, 17, 18, 19, 20, 21, 22, 23, 24 mm (L=38 mm); 27, 30, 32 mm (L=42 mm); CrV 50BV30: 1/2" (12.7 mm): 10, 12, 13, 14, 15, 17, 19 mm (L=76 mm); CrV 50BV30: 1/2" (12.7 mm) x 3/8" (9.5 mm), 1/2" (12.7 mm) x 7/16" (11.1 mm), 1/2" (12.7 mm) x 1/2" (12.7 mm), 1/2" (12.7 mm) x 9/16" (14.3 mm), 1/2" (12.7 mm) x 5/8" (15.9 mm), 1/2" (12.7 mm) x 11/16" (17.5 mm), 1/2" (12.7 mm) x 3/4" (19.0 mm), 1/2" (12.7 mm) x 13/16" (20.6 mm), 1/2" (12.7 mm) x 7/8" (22.2 mm), 1/2" (12.7 mm) x 15/16" (23.8 mm), 1/2" (12.7 mm) x 1" (25.4 mm); CrV 50BV30: 1/2" (12.7 mm): (127, 254 mm); CrV 50BV30: 3/8" (9.5 mm) (F) x 1/2" (12.7 mm) (M); CrV 50BV30: 1/2" (12.7 mm): CrV 50BV30: 1/2" (12.7 mm): 16, 21 mm; CrV 50BV30: 1/2" (12.7 mm): (255 mm); 72T; CrV 6140: 1/2" (12.7 mm): (250 mm); CrV 50BV30

YATO	Ø	
YT-3877	1/2" (12.7 mm)	6

GB Tool set
D Sechskant-Steckschlüssel-Satz
PL Zestaw narzędziowy
RUS Набор инструмента

CZ Sada nástrčných klíčů a ráčny
H Dugókulcs készlet racsnis hajtókarral
RO Rotrusa chei tubulare cu antrenor
F Coffret d'outillage

I Set di utensili
E Juego de herramientas
CN 套筒扳手组套

BMC & COLOR SLEEVE
M SIZE



72 PCS	1/2" 12.5mm	1/4" 6.3mm
CrV 50BV30	CrV 6140	
72T	AS-DRIVE	



1/2" (12.7 mm): 10, 11, 12, 13, 14, 15, 16, 17, 18, 19, 20, 21, 22, 23, 24 mm (L=38 mm); 27 mm (L=42 mm), 1/4" (6.3 mm): 4, 5, 6, 7, 8, 9, 10, 11, 12, 13 mm (L=25 mm); CrV 50BV30: 1/2" (12.7 mm): (127, 254 mm), 1/4" (6.3 mm): (152.4 mm); CrV 50BV30: 3/8" (9.5 mm) (F) x 1/2" (12.7 mm) (M); CrV 50BV30: 1/2" (12.7 mm): CrV 50BV30: 1/2" (12.7 mm): 21 mm; CrV 50BV30: 1/2" (12.7 mm): (255 mm), 1/4" (6.3 mm): (155 mm); 72T; CrV 6140: 1/4" (6.3 mm): (150 mm); CrV 50BV30: 1/4" (6.3 mm) x 1/4" (6.3 mm); CrV 6140: 1/4" (6.3 mm): 4, 5, 5.5, 6, 7 mm (L=25 mm); CrV 6150: 1/4" (6.3 mm): PH0, PH1, PH2, PH3 (L=25 mm); CrV 6150: 1/4" (6.3 mm): PZ0, PZ1, PZ2, PZ3 (L=25 mm); CrV 6150: 1/4" (6.3 mm): T8, T9, T10, T15, T20, T25, T27, T30, T40 (L=25 mm); CrV 6150: 1/4" (6.3 mm): 3, 4, 5, 6, 7, 8 mm (L=25 mm); CrV 6150: 1/4" (6.3 mm): S0, S1, S2, S3 (L=25 mm); CrV 6150: 1.25, 1.5, 2.5, 3 mm; CrV 6150

YATO	Ø	Ø	
YT-38782	1/2" (12.7 mm)	1/4" (6.3 mm)	4

GB Tool set
D Sechskant-Steckschlüssel-Satz
PL Zestaw narzędziowy
RUS Набор инструмента

CZ Sada nástrčných klíčů a ráčny
H Dugókulcs készlet racsnis hajtókarral
RO Rotrusa chei tubulare cu antrenor
F Coffret d'outillage

I Set di utensili
E Juego de herramientas
CN 套筒扳手组套

1/2" 12.5mm	1/4" 6.3mm
CrV 50BV30	CrV 6140
S2	72T
AS-DRIVE	



BMC & COLOR SLEEVE
L SIZE



77
PCS

CrV
6150

1/2" (12.7 mm): 10, 11, 12, 13, 14, 15, 17, 19, 22, 24 mm (L=38 mm); 27, 30, 32 mm (L=42 mm), 1/4" (6.3 mm): 4, 5, 6, 7, 8, 9, 10, 11, 12 mm (L=25 mm); CrV 50BV30; 1/2" (12.7 mm): (127, 254 mm), 1/4" (6.3 mm): (76, 101.6 mm); CrV 50BV30; 1/2" (12.7 mm), 1/4" (6.3 mm); CrV 50BV30; 1/2" (12.7 mm): 16, 21 mm; CrV 50BV30; 1/2" (12.7 mm); (255 mm), 1/4" (6.3 mm): (155 mm); 72T; CrV 6140; 1/4" (6.3 mm) x 1/4" (6.3 mm); CrV 6140; 1/4" (6.3 mm) x 1/4" (6.3 mm) (L=25 mm); CrV 6140; 1/4" (6.3 mm): 3, 4, 5, 5, 7 mm (L=25 mm); AISI S2; 1/4" (6.3 mm): PH0, PH1, PH2, PH3 (L=25 mm); AISI S2; 1/4" (6.3 mm): PZ1, PZ2, PZ3 (L=25 mm); AISI S2; 1/4" (6.3 mm): T10, T15, T20, T25, T30 (L=25 mm); AISI S2; 1/4" (6.3 mm): 2, 3, 4, 5, 6 mm (L=25 mm); AISI S2; 7, 8, 9, 10, 11, 12, 13, 14, 15, 17, 19 mm; CrV; 8x9, 10x11, 12x13, 14x15 mm; CrV 6140; 1.5, 2, 2.5, 5, 6, 8, 10 mm; CrV 6150

YATO	Ø	Ø	☐
YT-3878	1/2" (12.7 mm)	1/4" (6.3 mm)	2



BMC & COLOR SLEEVE
XXXL SIZE



79
PCS

CrV
60

CrV
55

CrMo
SVC55

SK5

1/2" (12.7 mm): 10, 11, 12, 13, 14, 16, 17, 19, 22, 24, 26 mm (L=38 mm); 27, 30, 32 mm (L=42 mm), 1/4" (6.3 mm): 5, 6, 7, 8, 9, 10, 11, 12, 13 mm (L=25 mm); CrV 50BV30; 1/2" (12.7 mm): 10, 11, 12, 13, 14, 17, 19 mm (L=76 mm); CrV 50BV30; 1/2" (12.7 mm); (127 mm), 1/4" (6.3 mm): (50.8 mm); CrV 50BV30; 1/2" (12.7 mm); (255 mm), 1/4" (6.3 mm): (155 mm); 72T; CrV 6140; 1/2" (12.7 mm); (255 mm); 1/4" (6.3 mm): (155 mm); CrV 50BV30; 1/2" (12.7 mm); (420 mm); CrV 50BV30; 6, 7, 8, 9, 10, 11, 12, 13, 14, 16, 17, 19, 22, 24 mm; CrV; 2.0x40, 2.4x75 mm; S2; 3.0x75, 4.0x100, 6.5x150, 8.0x150 mm; SVC55; PH0x75 mm; S2; PH1x75, PH2x100 mm; SVC55; 180 mm; CrV 55; 160 mm; CrV 55; 160, 200 mm; CrV 55; 250 mm; CrV; 300 g; 300 mm; 180 mm; CrMo; 120 mm; CrV 60; SK5; 2.5, 3, 4, 5, 6, 8, 10 mm; CrV

YATO	Ø	Ø	☐
YT-3891	1/2" (12.7 mm)	1/4" (6.3 mm)	2

GB Tool set
 D Sechskant-Steckschlüssel-Satz
 PL Zestaw narzędziowy
 RUS Набор инструмента

CZ Sada nástrčných klíčů a ráčny
 H Dugókulcs készlet racsnis hajtókarral
 RO Rotrușă chei tubulare cu antrenor
 F Coffret d'outillage

I Set di utensili
 E Juego de herramientas
 CN 套筒扳手套

BMC & COLOR SLEEVE
 L SIZE

1/2"	1/4"
12.5mm	6.3mm
CrV 50BV30	CrV 6150
CrV 6140	S2
72T	AS-DRIVE



2



82
PCS

1/2" (12.7 mm): 14, 15, 16, 17, 18, 19, 20, 22, 24 mm (L=38 mm); 27, 30, 32 mm (L=42 mm), 1/4" (6.3 mm): 4, 4.5, 5, 5.5, 6, 7, 8, 9, 10, 11, 12, 13, 14 mm (L=25 mm); CrV 50BV30; 1/2" (12.7 mm): (127, 254 mm), 1/4" (6.3 mm): (50.8, 101.6 mm); CrV 50BV30; 3/8" (9.5 mm) (F) x 1/2" (12.7 mm) (M); CrV 50BV30; 1/4" (6.3 mm): (150 mm); CrV 6140; 1/2" (12.7 mm), 1/4" (6.3 mm); CrV 50BV30; 1/2" (12.7 mm): 16, 21 mm; CrV 50BV30; 1/4" (6.3 mm): (152.4 mm); CrV 50BV30; 1/2" (12.7 mm): (255 mm), 1/4" (6.3 mm): (155 mm); 72T; CrV 6140; 1/4" (6.3 mm): (150 mm); CrV 50BV30; 1/2" (12.7 mm) x 5/16" (7.9 mm); CrV 6140; 1/4" (6.3 mm) x 1/4" (6.3 mm); CrV 6140; 5/16" (7.9 mm): 8, 10, 12 mm (L=30 mm); AISI S2; 5/16" (7.9 mm): PH3, PH4 (L=30 mm); AISI S2; 5/16" (7.9 mm): PZ3, PZ4 (L=30 mm); AISI S2; 5/16" (7.9 mm): T40, T45, T50, T55 (L=30 mm); AISI S2; 5/16" (7.9 mm): 8, 10, 12, 14 mm (L=30 mm); AISI S2; 1/4" (6.3 mm): 4, 5, 5, 7 mm (L=37 mm); AISI S2 / CrV 6150; 1/4" (6.3 mm): PH1, PH2 (L=37 mm); AISI S2 / CrV 6150; 1/4" (6.3 mm): PZ1, PZ2 (L=37 mm); AISI S2 / CrV 6150; 1/4" (6.3 mm): T8, T10, T15, T20, T25, T30 (L=37 mm); AISI S2 / CrV 6150; 1/4" (6.3 mm): 3, 4, 5, 6 mm (L=37 mm); AISI S2 / CrV 6150; 8, 10, 11, 12, 13, 14, 17, 19, 22 mm; CrV

YATO	Ø	Ø	☐
YT-1269	1/2" (12.7 mm)	1/4" (6.3 mm)	4



94
PCS

1/2" (12.7 mm): 10, 11, 12, 13, 14, 15, 16, 17, 18, 19, 20, 21, 22, 23, 24 mm (L=38 mm); 27, 30, 32 mm (L=42 mm), 1/4" (6.3 mm): 4, 4.5, 5, 5.5, 6, 7, 8, 9, 10, 11, 12, 13, 14 mm (L=25 mm); CrV 50BV30; 1/2" (12.7 mm): 14, 15, 17, 19 mm (L=76 mm), 1/4" (6.3 mm): 6, 7, 8, 9, 10, 11, 12, 13 mm (L=50 mm); CrV 50BV30; 1/2" (12.7 mm): (127, 254 mm), 1/4" (6.3 mm): (50.8, 101.6 mm); CrV 50BV30; 3/8" (9.5 mm) (F) x 1/2" (12.7 mm) (M); CrV 50BV30; 1/4" (6.3 mm): (150 mm); CrV 6140; 1/2" (12.7 mm), 1/4" (6.3 mm); CrV 50BV30; 1/2" (12.7 mm): 16, 21 mm; CrV 50BV30; 1/4" (6.3 mm): (152.4 mm); CrV 50BV30; 1/2" (12.7 mm): (255 mm), 1/4" (6.3 mm): (155 mm); 72T; CrV 6140; 1/4" (6.3 mm): (150 mm); CrV 50BV30; 1/2" (12.7 mm) x 5/16" (7.9 mm); CrV 6140; 1/4" (6.3 mm) x 1/4" (6.3 mm) (L=25 mm); CrV 6140; 5/16" (7.9 mm): 8, 10, 12 mm (L=30 mm); AISI S2; 5/16" (7.9 mm): PH3, PH4 (L=30 mm); AISI S2; 5/16" (7.9 mm): PZ3, PZ4 (L=30 mm); AISI S2; 5/16" (7.9 mm): T40, T45, T50, T55 (L=30 mm); AISI S2; 1/4" (6.3 mm): 4, 5, 5, 7 mm (L=37 mm); AISI S2 / CrV 6150; 1/4" (6.3 mm): PH1, PH2 (L=37 mm); AISI S2 / CrV 6150; 1/4" (6.3 mm): PZ1, PZ2 (L=37 mm); AISI S2 / CrV 6150; 1/4" (6.3 mm): T8, T10, T15, T20, T25, T30 (L=37 mm); AISI S2 / CrV 6150; 1/4" (6.3 mm): 3, 4, 5, 6 mm (L=37 mm); AISI S2 / CrV 6150; 1.5, 2.0, 2.5 mm; CrV 6150

YATO	Ø	Ø	☐
YT-1268	1/2" (12.7 mm)	1/4" (6.3 mm)	4

GB Tool set
D Sechskant-Steckschlüssel-Satz
PL Zestaw narzędziowy
RUS Набор инструмента

CZ Sada nástrčných klíčů a ráčny
H Dugókulcs készlet racsnis hajtókarral
RO Rotrușa chei tubulare cu antrenor
F Coffret d'outillage

I Set di utensili
E Juego de herramientas
CN 套筒扳手组套

BMC & COLOR SLEEVE
L SIZE



1/2" 12.5mm	1/4" 6.3mm
CrV 50BV30	CrV 6150
CrV 6140	S2
72T	AS-DRIVE

2



94
PCS

12pt

1/2" (12.7 mm): 10, 11, 12, 13, 14, 15, 16, 17, 18, 19, 20, 21, 22, 23, 24 mm (L=38 mm); 27, 30, 32 mm (L=42 mm), 1/4" (6.3 mm): 4, 4.5, 5, 5.5, 6, 7, 8, 9, 10, 11, 12, 13, 14 mm (L=25 mm); CrV 50BV30: 1/2" (12.7 mm): 14, 15, 17, 19 mm (L=76 mm), 1/4" (6.3 mm): 6, 7, 8, 9, 10, 11, 12, 13 mm (L=50 mm); CrV 50BV30: 1/2" (12.7 mm): (127, 254 mm), 1/4" (6.3 mm): (50.8, 101.6 mm); CrV 50BV30: 3/8" (9.5 mm) (F) x 1/2" (12.7 mm) (M); CrV 50BV30: 1/4" (6.3 mm): (150 mm); CrV 6140: 1/2" (12.7 mm), 1/4" (6.3 mm); CrV 50BV30: 1/2" (12.7 mm): 16, 21 mm; CrV 50BV30: 1/4" (6.3 mm); (152.4 mm); CrV 50BV30: 1/2" (12.7 mm): (255 mm), 1/4" (6.3 mm): (155 mm); 72T; CrV 6140: 1/4" (6.3 mm): (150 mm); CrV 50BV30: 1/2" (12.7 mm) x 5/16" (7.9 mm); CrV 6140: 1/4" (6.3 mm) x 1/4" (6.3 mm) (L=25 mm); CrV 6140: 5/16" (7.9 mm): 8, 10, 12 mm (L=30 mm); AISI S2: 5/16" (7.9 mm): PH3, PH4 (L=30 mm); AISI S2: 5/16" (7.9 mm): PZ3, PZ4 (L=30 mm); AISI S2: 5/16" (7.9 mm): T40, T45, T50, T55 (L=30 mm); AISI S2: 5/16" (7.9 mm): 8, 10, 12, 14 mm (L=30 mm); AISI S2: 1/4" (6.3 mm): 4, 5.5, 7 mm (L=37 mm); AISI S2 / CrV 6150: 1/4" (6.3 mm): PH1, PH2 (L=37 mm); AISI S2 / CrV 6150: 1/4" (6.3 mm): PZ1, PZ2 (L=37 mm); AISI S2 / CrV 6150: 1/4" (6.3 mm): T8, T10, T15, T20, T25, T30 (L=37 mm); AISI S2 / CrV 6150: 1/4" (6.3 mm): 3, 4, 5, 6 mm (L=37 mm); AISI S2 / CrV 6150: 1.5, 2.0, 2.5 mm; CrV 6150

YATO	Ø	Ø	
YT-12682	1/2" (12.7 mm)	1/4" (6.3 mm)	4



108
PCS

1/2" (12.7 mm): 10, 11, 12, 13, 14, 15, 16, 17, 18, 19, 20, 21, 22, 24 mm (L=38 mm); 27, 30, 32 mm (L=42 mm), 1/4" (6.3 mm): 4, 4.5, 5, 5.5, 6, 7, 8, 9, 10, 11, 12, 13, 14 mm (L=25 mm); CrV 50BV30: 1/2" (12.7 mm): 14, 15, 17, 19, 22 mm (L=76 mm), 1/4" (6.3 mm): 6, 7, 8, 9, 10, 11, 12, 13 mm (L=50 mm); CrV 50BV30: 1/2" (12.7 mm): E10, E11, E12, E14, E16, E18, E20, E24, 1/4" (6.3 mm): E4, E5, E6, E7, E8; CrV 50BV30: 1/2" (12.7 mm): (127, 254 mm), 1/4" (6.3 mm): (50.8, 101.6 mm); CrV 50BV30: 3/8" (9.5 mm) (F) x 1/2" (12.7 mm) (M); CrV 50BV30: 1/2" (12.7 mm), 1/4" (6.3 mm); CrV 50BV30: 1/2" (12.7 mm): 16, 21 mm; CrV 50BV30: 1/4" (6.3 mm); (152.4 mm); CrV 50BV30: 1/2" (12.7 mm): (255 mm), 1/4" (6.3 mm): (155 mm); 72T; CrV 6140: 1/4" (6.3 mm): (150 mm); CrV 50BV30: 1/2" (12.7 mm) x 5/16" (7.9 mm); CrV 6140: 5/16" (7.9 mm): 8, 10, 12 mm (L=30 mm); AISI S2: 5/16" (7.9 mm): PH3, PH4 (L=30 mm); AISI S2: 5/16" (7.9 mm): PZ3, PZ4 (L=30 mm); AISI S2: 5/16" (7.9 mm): T40, T45, T50, T55, T60 (L=30 mm); AISI S2: 1/4" (6.3 mm): 4, 5.5, 6.5 mm (L=37 mm); AISI S2 / CrV 6150: 1/4" (6.3 mm): PH1, PH2 (L=37 mm); AISI S2 / CrV 6150: 1/4" (6.3 mm): PZ1, PZ2 (L=37 mm); AISI S2 / CrV 6150: 1/4" (6.3 mm): T8, T10, T15, T20, T25, T27, T30 (L=37 mm); AISI S2 / CrV 6150: 1/4" (6.3 mm): 3, 4, 5, 6 mm (L=37 mm); AISI S2 / CrV 6150: 1.5, 2.0, 2.5 mm; CrV 6150

YATO	Ø	Ø	
YT-3879	1/2" (12.7 mm)	1/4" (6.3 mm)	2

GB Tool set
D Sechskant-Steckschlüssel-Satz
PL Zestaw narzędziowy
RUS Набор инструмента

CZ Sada nástrčných klíčů a ráčny
H Dugókulcs készlet racsnis hajtókarral
RO Rotrușă chei tubulare cu antrenor
F Coffret d'outillage

I Set di utensili
E Juego de herramientas
CN 套筒扳手手套

BMC & COLOR SLEEVE
XXL SIZE



1/2" 12.5mm	1/4" 6.3mm
CrV 50BV30	CrV 6150
CrV 6140	CrV 55
SVCM 55	S2
72T	AS-DRIVE

2



122
PCS

1/2" (12.7 mm): 12, 13, 14, 15, 16, 17, 18, 19, 20, 21, 22, 24 mm (L=38 mm); 27, 30, 32 mm (L=42 mm), 1/4" (6.3 mm): 4, 4.5, 5, 5.5, 6, 7, 8, 9, 10, 11, 12, 13, 14 mm (L=25 mm); CrV 50BV30: 1/2" (12.7 mm): 10, 12, 13, 14, 17, 19 mm (L=76 mm), 1/4" (6.3 mm): 4, 5, 6, 7, 8, 9 mm (L=50 mm); CrV 50BV30: 1/2" (12.7 mm): E10, E12, E14, E16, E18, E20, E22, E24; CrV 50BV30: 1/2" (12.7 mm): (254 mm), 1/4" (6.3 mm): (152.4 mm); CrV 50BV30: 3/8" (9.5 mm) (F) x 1/2" (12.7 mm) (M), 3/8" (9.5 mm) (F) x 1/4" (6.3 mm) (M); CrV 50BV30: 1/2" (12.7 mm), 1/4" (6.3 mm); CrV 50BV30: 1/2" (12.7 mm): 16, 21 mm; CrV 50BV30: 1/2" (12.7 mm): (255 mm), 1/4" (6.3 mm): (155 mm); 72T; CrV 6140: 1/4" (6.3 mm): (150 mm); CrV 50BV30: 1/4" (6.3 mm) x 1/4" (6.3 mm); CrV 6140: 1/4" (6.3 mm): 3, 4, 5, 6 mm (L=25 mm); AISI S2: 1/4" (6.3 mm): PH0, PH1, PH2 (L=25 mm); AISI S2: 1/4" (6.3 mm): PZ0, PZ1, PZ2 (L=25 mm); AISI S2: 1/4" (6.3 mm): 4.0, 5.5, 6.5 mm (L=37 mm); AISI S2 / CrV 6150: 1/4" (6.3 mm): PH1, PH2, PH3 (L=37 mm); AISI S2 / CrV 6150: 1/4" (6.3 mm): PH0, PH1, PH2 (L=25 mm); AISI S2 / CrV 6150: 1/4" (6.3 mm): T8, T10, T15, T20, T25 (L=37 mm); AISI S2 / CrV 6150: 1/4" (6.3 mm): T10, T15, T20, T25, T40 (L=37 mm); AISI S2 / CrV 6150: 1/4" (6.3 mm): 3, 4, 5, 6 mm (L=37 mm); AISI S2 / CrV 6150: 8, 9, 10, 11, 12, 13, 14, 15, 16, 17, 18, 19 mm; CrV: 4x100, 6.5x150, PH2x100, PH3x150 mm; SVCM55: 180 mm; CrV 55: 160 mm; CrV 55: 160 mm; CrV 55: 250 mm; CrV: 2, 2.5, 3, 4, 5, 6, 7, 8, 10 mm; CrV 6150

YATO	1/2" (12.7 mm)	1/4" (6.3 mm)	2
YT-3890			

GB Tool set
D Sechskant-Steckschlüssel-Satz
PL Zestaw narzędziowy
RUS Набор инструмента

CZ Sada nástrčných klíčů a ráčny
H Dugókulcs készlet racsnis hajtókarral
RO Rotrușă chei tubulare cu antrenor
F Coffret d'outillage

I Set di utensili
E Juego de herramientas
CN 套筒扳手手套

BMC & COLOR SLEEVE
XL SIZE



1/2" 12.5mm	3/8" 10mm	1/4" 6.3mm
CrV 50BV30	CrV 6150	CrV 6140
S2	72T	AS-DRIVE



111
PCS

1/2" (12.7 mm): 14, 15, 16, 17, 18, 19, 20, 21, 22, 23, 24 mm (L=38 mm); 27, 30, 32 mm (L=42 mm), 3/8" (9.5 mm): 9, 10, 11, 12, 13, 14, 15, 16 mm (L=28 mm); 17, 18, 19 mm (L=30 mm), 1/4" (6.3 mm): 3.5, 4, 4.5, 5, 5.5, 6, 7, 8, 9, 10, 11, 12, 13 mm (L=25 mm); CrV 50BV30: 1/2" (12.7 mm): (127, 254 mm), 3/8" (9.5 mm): (76, 152.4 mm), 1/4" (6.3 mm): (50.8, 152.4 mm); CrV 50BV30: 3/8" (9.5 mm) (F) x 1/2" (12.7 mm) (M), 1/2" (12.7 mm) (F) x 3/8" (9.5 mm) (M), 3/8" (9.5 mm) (F) x 1/4" (6.3 mm) (M); CrV 50BV30: 1/2" (12.7 mm), 3/8" (9.5 mm), 1/4" (6.3 mm); CrV 50BV30: 1/2" (12.7 mm): 16, 21 mm, 3/8" (9.5 mm); 16, 21 mm; CrV 50BV30: 1/2" (12.7 mm): (255 mm), 3/8" (9.5 mm): (200 mm), 1/4" (6.3 mm): (155 mm); 72T; CrV 6140: 1/4" (6.3 mm): (150 mm); CrV 50BV30: 1/2" (12.7 mm) x 5/16" (7.9 mm), 3/8" (9.5 mm) x 5/16" (7.9 mm); CrV 6140: 5/16" (7.9 mm): 6, 6.5, 8 mm (L=30 mm); AISI S2: 5/16" (7.9 mm): PH2, PH3 (L=30 mm); AISI S2: 5/16" (7.9 mm): PZ2, PZ3 (L=30 mm); AISI S2: 5/16" (7.9 mm): T27, T30, T35, T40, T45 (L=30 mm); AISI S2: 5/16" (7.9 mm): 5.5, 6, 6.5 mm (L=30 mm); AISI S2: 1/4" (6.3 mm): 4, 5.5, 6.5 mm (L=37 mm); AISI S2 / CrV 6150: 1/4" (6.3 mm): PH1, PH2 (L=37 mm); AISI S2 / CrV 6150: 1/4" (6.3 mm): PZ1, PZ2 (L=37 mm); AISI S2 / CrV 6150: 1/4" (6.3 mm): T8, T10, T15, T20, T25 (L=37 mm); AISI S2 / CrV 6150: 1/4" (6.3 mm): T10, T15, T20, T25, T40 (L=37 mm); AISI S2 / CrV 6150: 1/4" (6.3 mm): 3, 4, 5, 6 mm (L=37 mm); AISI S2 / CrV 6150: 8, 9, 10, 11, 12, 13, 14, 15, 16, 17, 18, 19 mm; CrV: 1.5, 2, 2.5 mm; CrV 6150

YATO	1/2" (12.7 mm)	3/8" (9.5 mm)	1/4" (6.3 mm)	2
YT-3883				

GB Tool set
D Sechskant-Steckschlüssel-Satz
PL Zestaw narzędziowy
RUS Набор инструмента

CZ Sada nástrčných klíčů a ráčny
H Dugókulcs készlet racsnis hajtókarral
RO Rotrusa chei tubulare cu antrenor
F Coffret d'outillage

I Set di utensili
E Juego de herramientas
CN 套筒扳手组套

BMC & COLOR SLEEVE
XL SIZE





1/2" 12.5mm	3/8" 10mm	1/4" 6.3mm
CrV 50BV30	CrV 6150	CrV 6140
S2	72T	AS-DRIVE





2



120
PCS

















METRIC
& S.A.E.



1/2" (12.7 mm): 20, 21, 22, 24 mm (L=38 mm); 27, 30, 32 mm (L=42 mm); 3/8" (9.5 mm): 9, 10, 11, 12, 13, 14, 15, 16 mm (L=28 mm); 17, 18, 19 mm (L=30 mm); 1/4" (6.3 mm): 4, 5, 6, 7, 8, 9, 10, 11, 12, 13 mm (L=25 mm); CrV 50BV30:  3/8" (9.5 mm): 13, 14, 15, 17 mm (L=63 mm); 1/4" (6.3 mm): 8, 9, 10, 12 mm (L=50 mm); CrV 50BV30:  1/2" (12.7 mm) x 15/16" (23.8 mm); 1/2" (12.7 mm) x 1" (25.4 mm); 1/2" (12.7 mm) x 1-1/16" (27.0 mm); 1/2" (12.7 mm) x 1-1/4" (31.8 mm); 3/8" (9.5 mm) x 3/8" (9.5 mm); 3/8" (9.5 mm) x 7/16" (11.1 mm); 3/8" (9.5 mm) x 1/2" (12.7 mm); 3/8" (9.5 mm) x 9/16" (14.3 mm); 3/8" (9.5 mm) x 5/8" (15.9 mm); 3/8" (9.5 mm) x 11/16" (17.5 mm); 3/8" (9.5 mm) x 3/4" (19.0 mm); 3/8" (9.5 mm) x 13/16" (20.6 mm); 3/8" (9.5 mm) x 7/8" (22.2 mm); 1/4" (6.3 mm) x 5/32" (4.0 mm); 1/4" (6.3 mm) x 3/16" (4.8 mm); 1/4" (6.3 mm) x 7/32" (5.6 mm); 1/4" (6.3 mm) x 1/4" (6.3 mm); 1/4" (6.3 mm) x 9/32" (7.1 mm); 1/4" (6.3 mm) x 5/16" (7.9 mm); 1/4" (6.3 mm) x 11/32" (8.7 mm); 1/4" (6.3 mm) x 3/8" (9.5 mm); 1/4" (6.3 mm) x 7/16" (11.1 mm); 1/4" (6.3 mm) x 1/2" (12.7 mm); CrV 50BV30:  1/2" (12.7 mm): 17, 19, 21, 23 mm; CrV 50BV30:  3/8" (9.5 mm): E8, E10, E11, E12, E14, E16, E18, E20; CrV 50BV30:  1/2" (12.7 mm): (127, 254 mm); 3/8" (9.5 mm): (76, 152.4 mm); 1/4" (6.3 mm): (50.8 mm); CrV 50BV30:  1/2" (12.7 mm); 3/8" (9.5 mm); 1/4" (6.3 mm); CrV 50BV30:  3/8" (9.5 mm): 16, 21 mm; CrV 50BV30:  1/2" (12.7 mm); (255 mm); 3/8" (9.5 mm); (200 mm); 1/4" (6.3 mm); (155 mm); 72T: CrV 6140:  1/4" (6.3 mm); (150 mm); CrV 50BV30:  1/4" (6.3 mm) x 1/4" (6.3 mm); CrV 6140:  1/4" (6.3 mm): T10, T15, T20, T25, T27, T30, T40 (L=25 mm); AISI S2:  3/8" (9.5 mm): 5.5, 6.5 mm (L=50 mm); AISI S2 / CrV 6150:  3/8" (9.5 mm): PH1, PH2 (L=50 mm); AISI S2 / CrV 6150:  3/8" (9.5 mm): PZ1, PZ2 (L=50 mm); AISI S2 / CrV 6150:  3/8" (9.5 mm): T20, T30, T40, T45, T50, T55, T60 (L=50 mm); AISI S2 / CrV 6150:  3/8" (9.5 mm): 3, 4, 5, 6 mm (L=50 mm); AISI S2 / CrV 6150:  8, 9, 10, 11, 12, 13, 14, 17, 18, 19 mm; CrV

YATO 				
YT-3880	1/2" (12.7 mm)	3/8" (9.5 mm)	1/4" (6.3 mm)	2



128
PCS

1/2" (12.7 mm): 14, 15, 16, 17, 18, 19, 20, 21, 22, 24 mm (L=38 mm); 27, 30, 32 mm (L=42 mm); 3/8" (9.5 mm): 10, 11, 12, 13, 14, 15, 16 mm (L=28 mm); 17, 18 mm (L=30 mm); 1/4" (6.3 mm): 6, 7, 8, 9, 10, 11, 12, 13 mm (L=25 mm); CrV 50BV30:  1/2" (12.7 mm): 17, 18, 19, 22 mm (L=76 mm); 3/8" (9.5 mm): 8, 10, 12, 13, 14, 15 mm (L=63 mm); 1/4" (6.3 mm): 6, 7, 8, 10, 12, 13 mm (L=50 mm); CrV 50BV30:  1/2" (12.7 mm): 17, 19, 21, 22 mm; CrV 50BV30:  3/8" (9.5 mm): E8, E10, E11, E12, E14, E16; CrV 50BV30:  1/2" (12.7 mm): (127, 254 mm); 3/8" (9.5 mm): (152.4, 254 mm); 1/4" (6.3 mm): (50.8, 101.6 mm); CrV 50BV30:  3/8" (9.5 mm) (F) x 1/2" (12.7 mm) (M); CrV 50BV30:  1/2" (12.7 mm); 3/8" (9.5 mm); 1/4" (6.3 mm); CrV 50BV30:  1/2" (12.7 mm): 16, 21 mm; CrV 50BV30:  3/8" (9.5 mm): (198 mm); 1/4" (6.3 mm): (152.4 mm); CrV 50BV30:  1/2" (12.7 mm): (255 mm); 3/8" (9.5 mm); (200 mm); 1/4" (6.3 mm); (155 mm); 72T: CrV 6140:  1/4" (6.3 mm); (150 mm); CrV 50BV30:  1/2" (12.7 mm); (250 mm); CrV 50BV30:  3/8" (9.5 mm) x 5/16" (7.9 mm); CrV 6140:  1/2" (12.7 mm) x 3/8" (9.5 mm); 3/8" (9.5 mm) x 1/4" (6.3 mm); CrV 50BV30:  1/4" (6.3 mm) x 1/4" (6.3 mm); CrV 6140:  3/8" (9.5 mm): 5.5, 6.5 mm (L=70 mm); AISI S2:  3/8" (9.5 mm): PH1, PH2, PH3 (L=70 mm); AISI S2:  3/8" (9.5 mm): T20, T30, T40, T45, T50, T55 (L=70 mm); AISI S2: 3/8" (9.5 mm): 6, 7, 8, 10, 12 mm (L=70 mm); AISI S2: 1/4" (6.3 mm): PZ1, PZ2 (L=25 mm); AISI S2: 1/4" (6.3 mm): T8, T10 (L=25 mm); AISI S2: 1/4" (6.3 mm): 4.0, 5.5, 6.5 mm (L=37 mm); AISI S2 / CrV 6150: 1/4" (6.3 mm): PH1, PH2 (L=37 mm); AISI S2 / CrV 6150: 1/4" (6.3 mm): T8, T10, T15, T20, T25, T30, T40 (L=37 mm); AISI S2 / CrV 6150: 1/4" (6.3 mm): 3, 4, 5, 6 mm (L=37 mm); AISI S2 / CrV 6150: 8, 10, 12, 13, 14, 15, 16, 17, 18, 19 mm; CrV; 1.5, 2, 2.5 mm; CrV 6150

YATO 				
YT-3887	1/2" (12.7 mm)	3/8" (9.5 mm)	1/4" (6.3 mm)	2

GB Tool set
 D Sechskant-Steckschlüssel-Satz
 PL Zestaw narzędziowy
 RUS Набор инструмента

CZ Sada nástrčných klíčů a ráčny
 H Dugókulcs készlet racsnis hajtókarral
 RO Rotruşa chei tubulare cu antrenor
 F Coffret d'outillage

I Set di utensili
 E Juego de herramientas
 CN 套筒扳手套装

1/2" 12.5mm	3/8" 10mm	1/4" 6.3mm
CrV 50BV30	CrV 6150	CrV 6140
S2	72T	AS-DRIVE

2



150
PCS

METRIC & S.A.E.

BMC
& COLOR
SLEEVE
XXL SIZE



1/2" (12.7 mm): 20, 21, 22, 24 mm (L=38 mm); 27, 30, 32 mm (L=42 mm), 3/8" (9.5 mm): 9, 10, 11, 12, 13, 14, 15, 16 mm (L=28 mm); 17, 18, 19 mm (L=30 mm), 1/4" (6.3 mm): 4, 5, 6, 7, 8, 9, 10, 11, 12, 13 mm (L=25 mm); CrV 50BV30: 1/2" (12.7 mm): 10, 12, 13, 14, 17, 19 mm (L=76 mm), 3/8" (9.5 mm): 10, 11, 12, 13, 14, 15 mm (L=63 mm), 1/4" (6.3 mm): 4, 5, 6, 7, 8, 9 mm (L=50 mm); CrV 50BV30: 1/2" (12.7 mm) x 15/16" (23.8 mm), 1/2" (12.7 mm) x 1" (25.4 mm), 1/2" (12.7 mm) x 1-1/16" (27.0 mm), 1/2" (12.7 mm) x 1-1/4" (31.8 mm), 3/8" (9.5 mm) x 3/8" (9.5 mm), 3/8" (9.5 mm) x 7/16" (11.1 mm), 3/8" (9.5 mm) x 1/2" (12.7 mm), 3/8" (9.5 mm) x 9/16" (14.3 mm), 3/8" (9.5 mm) x 5/8" (15.9 mm), 3/8" (9.5 mm) x 11/16" (17.5 mm), 3/8" (9.5 mm) x 3/4" (19.0 mm), 3/8" (9.5 mm) x 13/16" (20.6 mm), 3/8" (9.5 mm) x 7/8" (22.2 mm), 1/4" (6.3 mm) x 5/32" (4.0 mm), 1/4" (6.3 mm) x 3/16" (4.8 mm), 1/4" (6.3 mm) x 7/32" (5.6 mm), 1/4" (6.3 mm) x 1/4" (6.3 mm), 1/4" (6.3 mm) x 9/32" (7.1 mm), 1/4" (6.3 mm) x 5/16" (7.9 mm), 1/4" (6.3 mm) x 11/32" (8.7 mm), 1/4" (6.3 mm) x 3/8" (9.5 mm), 1/4" (6.3 mm) x 7/16" (11.1 mm), 1/4" (6.3 mm) x 1/2" (12.7 mm); CrV 50BV30: 1/2" (12.7 mm): 17, 19, 21, 23 mm; CrV 50BV30: 3/8" (9.5 mm): E8, E10, E11, E12, E14, E16, E18, E20; CrV 50BV30: 1/2" (12.7 mm): (127, 254 mm), 3/8" (9.5 mm): (76, 152, 4 mm), 1/4" (6.3 mm): (50.8 mm); CrV 50BV30: 1/2" (12.7 mm), 3/8" (9.5 mm), 1/4" (6.3 mm); CrV 50BV30: 3/8" (9.5 mm): 16, 21 mm; CrV 50BV30: 1/2" (12.7 mm): (255 mm), 3/8" (9.5 mm): (200 mm), 1/4" (6.3 mm): (155 mm); 72T; CrV 6140: 1/4" (6.3 mm): (150 mm); CrV 50BV30: 1/4" (6.3 mm) x 1/4" (6.3 mm); CrV 6140: 1/4" (6.3 mm): T10, T15, T20, T25, T27, T30, T40 (L=25 mm); AISI S2: 1/4" (6.3 mm): 4, 5, 5.5, 6.5 mm (L=50 mm); AISI S2 / CrV 6150: 3/8" (9.5 mm): PH1, PH2, PH3 (L=50 mm); AISI S2 / CrV 6150: 3/8" (9.5 mm): PZ1, PZ2, PZ3 (L=50 mm); AISI S2 / CrV 6150: 3/8" (9.5 mm): T20, T30, T40, T45, T50, T55, T60 (L=50 mm); AISI S2 / CrV 6150: 3/8" (9.5 mm): 3, 4, 5, 6, 8, 10 mm (L=50 mm); AISI S2 / CrV 6150: 8, 9, 10, 11, 12, 13, 14, 15, 16, 17, 18, 19 mm; CrV: 8x10, 12x13, 17x19 mm; 1.5, 2, 2.5, 3, 4, 5, 6, 7, 8, 10 mm; CrV 6150

YATO	1/2" (12.7 mm)	3/8" (9.5 mm)	1/4" (6.3 mm)	2
YT-3881	1/2" (12.7 mm)	3/8" (9.5 mm)	1/4" (6.3 mm)	2



173
PCS

BMC
& COLOR
SLEEVE
XL SIZE



1/2" (12.7 mm): 10, 11, 12, 13, 14, 15, 16, 17, 18, 19, 20, 21, 22, 23, 24 mm (L=38 mm); 27, 30, 32 mm (L=42 mm), 3/8" (9.5 mm): 10, 11, 12, 13, 14, 15, 16 mm (L=28 mm); 17, 18, 19 mm (L=30 mm), 1/4" (6.3 mm): 4, 4.5, 5, 5.5, 6, 7, 8, 9, 10, 11, 12, 13, 14 mm (L=25 mm); CrV 50BV30: 1/2" (12.7 mm): 16, 17, 18, 19, 22 mm (L=76 mm), 3/8" (9.5 mm): 10, 11, 12, 13, 14, 15 mm (L=63 mm), 1/4" (6.3 mm): 4, 5, 6, 7, 8, 9, 10 mm (L=50 mm); CrV 50BV30: 1/2" (12.7 mm): E18, E20, E24, 3/8" (9.5 mm): E10, E11, E12, E14, E16, 1/4" (6.3 mm): E4, E5, E6, E7, E8; CrV 50BV30: 1/2" (12.7 mm): (127, 254 mm), 3/8" (9.5 mm): (152, 4 mm), 1/4" (6.3 mm): (50.8, 101.6 mm); CrV 50BV30: 3/8" (9.5 mm) (F) x 1/2" (12.7 mm) (M); CrV 50BV30: 1/2" (12.7 mm), 3/8" (9.5 mm), 1/4" (6.3 mm); CrV 50BV30: 1/2" (12.7 mm): 16, 21 mm, 3/8" (9.5 mm): 18 mm; CrV 50BV30: 1/4" (6.3 mm): (152, 4 mm); CrV 50BV30: 1/2" (12.7 mm): (255 mm), 3/8" (9.5 mm): (200 mm), 1/4" (6.3 mm): (155 mm); 72T; CrV 6140: 1/4" (6.3 mm): (150 mm); CrV 50BV30: 1/4" (6.3 mm) x 1/4" (6.3 mm); CrV 6140: 1/4" (6.3 mm): 5/16" (7.9 mm); 3/8" (9.5 mm) x 5/16" (7.9 mm); 3/8" (9.5 mm) x 1/4" (6.3 mm); CrV 6140: 3/8" (9.5 mm) x 5/16" (7.9 mm); 8, 10, 12 mm (L=30 mm); AISI S2: 5/16" (7.9 mm): PH3, PH4 (L=30 mm); AISI S2: 5/16" (7.9 mm): PZ3, PZ4 (L=30 mm); AISI S2: 5/16" (7.9 mm): T40, T45, T50, T55, T60, T70 (L=30 mm); AISI S2: 5/16" (7.9 mm): T40, T45, T50, T55, T60, T70 (L=30 mm); AISI S2: 5/16" (7.9 mm): 7, 8, 10, 12, 14 mm (L=30 mm); AISI S2: 1/4" (6.3 mm): T5, T6, T7 (L=25 mm); AISI S2: 1/4" (6.3 mm): T7, T10, T15, T20, T25, T27, T30, T40, T45 (L=25 mm); AISI S2: 1/4" (6.3 mm): M5, M6, M8 (L=25 mm); AISI S2: 1/4" (6.3 mm): RM5, RM6, RM7, RM8, RM9 (L=25 mm); AISI S2: 1/4" (6.3 mm): 4, 5.5, 6.5, 7 mm (L=37 mm); AISI S2 / CrV 6150: 1/4" (6.3 mm): PH0, PH1, PH2 (L=37 mm); AISI S2 / CrV 6150: 1/4" (6.3 mm): PZ0, PZ1, PZ2 (L=37 mm); AISI S2 / CrV 6150: 1/4" (6.3 mm): T8, T9, T10, T15, T20, T25, T27, T30 (L=37 mm); AISI S2 / CrV 6150: 1/4" (6.3 mm): T8, T9, T10, T15, T20, T25, T27, T30 (L=37 mm); AISI S2 / CrV 6150: 1/4" (6.3 mm): 3, 4, 5, 6 mm (L=37 mm); AISI S2 / CrV 6150: 1.25, 1.5, 2, 2.5, 3, 4, 5 mm; CrV 6150

YATO	1/2" (12.7 mm)	3/8" (9.5 mm)	1/4" (6.3 mm)	2
YT-3893	1/2" (12.7 mm)	3/8" (9.5 mm)	1/4" (6.3 mm)	2

GB Tool set
D Sechskant-Steckschlüssel-Satz
PL Zestaw narzędziowy
RUS Набор инструмента

CZ Sada nástrčných klíčů a ráčny
H Dugókulcs készlet racsni hajtókarral
RO Roturasa chei tubulare cu antrenor
F Coffret d'outillage

I Set di utensili
E Juego de herramientas
CN 套筒扳手套装

1/2" 12.5mm	3/8" 10mm	1/4" 6.3mm	CrV 50BV30	CrV 6150
CrV 6140	S2	72T	AS-DRIVE	MAGNETIC

2

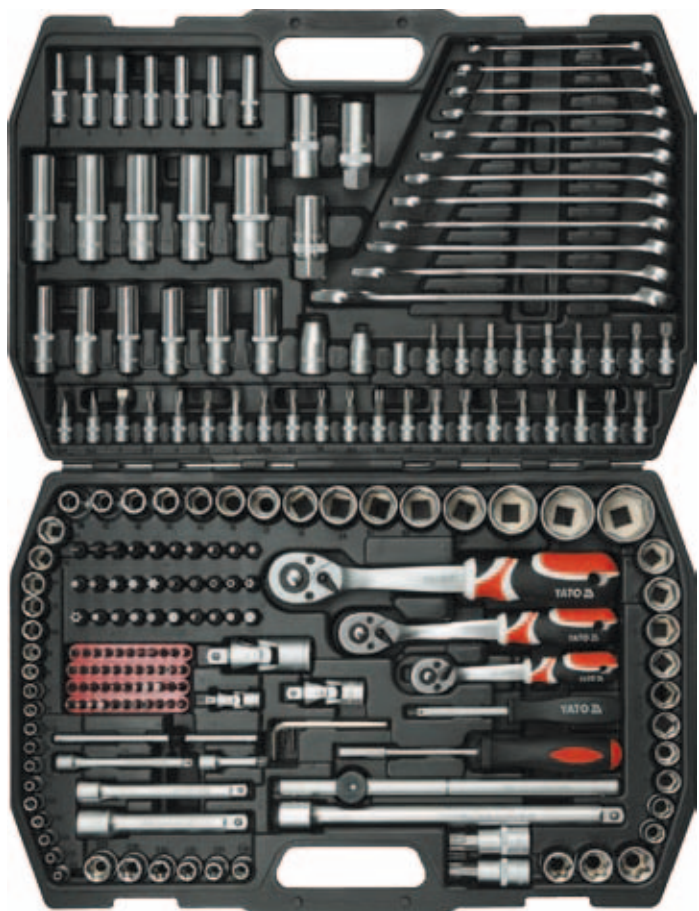

216
PCS

BMC & COLOR
SLEEVE
XXL SIZE



1/2" (12.7 mm): 10, 11, 12, 13, 14, 15, 17, 19, 20, 21, 22, 24 mm (L=38 mm); 27, 30, 32 mm (L=42 mm); 3/8" (9.5 mm): 10, 11, 12, 13, 14, 15, 16 mm (L=28 mm); 17, 18, 19 mm (L=30 mm); 1/4" (6.3 mm): 4, 4.5, 5, 5.5, 6, 7, 8, 9, 10, 11, 12, 13, 14 mm (L=25 mm); CrV 50BV30: 1/2" (12.7 mm): 16, 17, 18, 19, 22 mm (L=76 mm); 3/8" (9.5 mm): 10, 11, 12, 13, 14, 15 mm (L=63 mm); 1/4" (6.3 mm): 4, 5, 6, 7, 8, 9, 10 mm (L=50 mm); CrV 50BV30: 1/2" (12.7 mm): E20, E22, E24, 3/8" (9.5 mm): E10, E11, E12, E14, E16, E18, 1/4" (6.3 mm): E4, E5, E6, E7; E8; CrV 50BV30: 1/2" (12.7 mm): (127, 254 mm); 3/8" (9.5 mm): (125 mm); 1/4" (6.3 mm): (50.8, 101.6 mm); CrV 50BV30: 1/2" (12.7 mm); 3/8" (9.5 mm); 1/4" (6.3 mm); CrV 50BV30: 1/2" (12.7 mm): 16, 21 mm; 3/8" (9.5 mm): 18 mm; CrV 50BV30: 1/2" (12.7 mm): (255 mm); 1/4" (6.3 mm): (152.4 mm); CrV 50BV30: 1/2" (12.7 mm): (255 mm); 3/8" (9.5 mm): (200 mm); 1/4" (6.3 mm): (155 mm); 72T: CrV 6140: 1/4" (6.3 mm): (150 mm); CrV 50BV30: 1/4" (6.3 mm): (200 mm); CrV 6140: 1/2" (12.7 mm) x 5/16" (7.9 mm); 3/8" (9.5 mm) x 5/16" (7.9 mm); CrV 6140: 1/4" (6.3 mm) x 1/4" (6.3 mm); CrV 6140: 5/16" (7.9 mm); 6, 6.5, 8 mm (L=30 mm); AISI S2: 5/16" (7.9 mm): PH3, PH4 (L=30 mm); AISI S2: 5/16" (7.9 mm): PZ3, PZ4 (L=30 mm); AISI S2: 5/16" (7.9 mm): T25, T27, T30, T35, 2xT40, T45, T50 (L=30 mm); AISI S2: 5/16" (7.9 mm): T27, T30, T35, T40, T45, T50 (L=30 mm); AISI S2: 5/16" (7.9 mm): 5.5, 6, 6.5, 7, 8 mm (L=30 mm); AISI S2: 5/16" (7.9 mm): M5, M6, M8, M10 (L=30 mm); AISI S2: 1/4" (6.3 mm): 4, 5.5, 6.5 mm (L=25 mm); AISI S2: 1/4" (6.3 mm): PH1, PH2 (L=25 mm); AISI S2: 1/4" (6.3 mm): PZ1, PZ2 (L=25 mm); AISI S2: 1/4" (6.3 mm): T8, T10, T15, T20, T25 (L=25 mm); AISI S2: 1/4" (6.3 mm): T8, 2xT10, 2xT15, 2xT20, 2xT25, T40 (L=25 mm); AISI S2: 1/4" (6.3 mm): 3, 4, 5, 6 mm (L=25 mm); AISI S2: 1/4" (6.3 mm): M5, M6, M8 (L=25 mm); AISI S2: 1/4" (6.3 mm): S1, S2 (L=25 mm); AISI S2: 1/4" (6.3 mm): 1, 2, 3 mm (L=25 mm); AISI S2: 1/4" (6.3 mm): 6, 8, 10 mm (L=25 mm); AISI S2: 1/2" (12.7 mm): 1/4" (6.3 mm): 4, 6, 8 mm (L=25 mm); AISI S2: 1/2" (12.7 mm): T55, T60 (L=50 mm); AISI S2 / CrV 6150: 1/4" (6.3 mm): 6, 6.5, 8 mm (L=37 mm); AISI S2 / CrV 6150: 1/4" (6.3 mm): PH3, PH4 (L=37 mm); AISI S2 / CrV 6150: 1/4" (6.3 mm): PZ3, PZ4 (L=37 mm); AISI S2 / CrV 6150: 1/4" (6.3 mm): T25, T27, T30, T35, 2xT40, T45, T50 (L=37 mm); AISI S2 / CrV 6150: 1/4" (6.3 mm): T27, T30, T35, T40, T45, T50 (L=37 mm); AISI S2 / CrV 6150: 1/4" (6.3 mm): 5.5, 6, 6.5, 7, 8 mm (L=37 mm); AISI S2 / CrV 6150: 1/4" (6.3 mm): M5, M6, M8, M10 (L=37 mm); AISI S2 / CrV 6150: 8, 10, 11, 12, 13, 14, 15, 16, 17, 18, 19, 22 mm; CrV: 1.27, 1.5, 2, 2.5, 3, 4, 5 mm; CrV 6150

YATO	○	○	○	📦
YT-3884	1/2" (12.7 mm)	3/8" (9.5 mm)	1/4" (6.3 mm)	2



224
PCS

CrV
55

METRIC
& S.A.E.

BMC & COLOR
SLEEVE
XXXL SIZE



1/2" (12.7 mm): 10, 13, 15, 16, 17, 18, 19, 20, 21, 22, 23, 24 mm (L=38 mm); 27, 30, 32 mm (L=42 mm); 3/8" (9.5 mm): 10, 11, 12, 13, 14, 15, 16 mm (L=28 mm); 17, 18, 19 mm (L=30 mm); 1/4" (6.3 mm): 3.5, 4, 4.5, 5, 5.5, 6, 7, 8, 9, 10, 11, 12, 13, 14 mm (L=25 mm); CrV 50BV30: 1/2" (12.7 mm): 10, 11, 12, 13, 14, 15, 17, 19, 21 mm (L=76 mm); 3/8" (9.5 mm): 6, 7, 8, 9, 10 mm (L=63 mm); CrV 50BV30: 1/2" (12.7 mm) x 7/16" (11.1 mm); 1/2" (12.7 mm) x 1/2" (12.7 mm); 1/2" (12.7 mm) x 9/16" (14.3 mm); 1/2" (12.7 mm) x 5/8" (15.9 mm); 1/2" (12.7 mm) x 11/16" (17.5 mm); 1/2" (12.7 mm) x 3/4" (19.0 mm); 1/2" (12.7 mm) x 13/16" (20.6 mm); 1/2" (12.7 mm) x 7/8" (22.2 mm); 1/4" (6.3 mm) x 1/4" (6.3 mm); 1/4" (6.3 mm) x 9/32" (7.1 mm); 1/4" (6.3 mm) x 5/16" (7.9 mm); 1/4" (6.3 mm) x 11/32" (8.7 mm); 1/4" (6.3 mm) x 3/8" (9.5 mm); CrV 50BV30: 1/2" (12.7 mm): 17, 19, 21 mm; CrV 50BV30: 1/2" (12.7 mm): E16, E18, E20, E22, E24, 3/8" (9.5 mm): E10, E11, E12, E14, 1/4" (6.3 mm): E4, E5, E6, E7; E8; CrV 50BV30: 1/2" (12.7 mm): (127, 254 mm); 3/8" (9.5 mm): (76, 254 mm); 1/4" (6.3 mm): (50.8, 101.6 mm); CrV 50BV30: 3/8" (9.5 mm) (F) x 1/2" (12.7 mm) (M); 1/2" (12.7 mm) (F) x 3/8" (9.5 mm) (M); CrV 50BV30: 1/2" (12.7 mm); 3/8" (9.5 mm); 1/4" (6.3 mm); CrV 50BV30: 1/2" (12.7 mm): 16, 21 mm; 3/8" (9.5 mm); 18 mm; CrV 50BV30: 1/4" (6.3 mm): (152.4 mm); CrV 50BV30: 1/2" (12.7 mm): (255 mm); 3/8" (9.5 mm): (200 mm); 1/4" (6.3 mm): (155 mm); 72T: CrV 6140: 1/4" (6.3 mm): (150 mm); CrV 50BV30: 1/4" (6.3 mm): (200 mm); CrV 6140: 1/2" (12.7 mm) x 5/16" (7.9 mm); 3/8" (9.5 mm) x 5/16" (7.9 mm); 3/8" (9.5 mm) x 1/4" (6.3 mm); CrV 6140: 1/4" (6.3 mm) x 1/4" (6.3 mm); CrV 6140: 5/16" (7.9 mm); 6, 6.5, 7, 8, 9 mm (L=25 mm); AISI S2: 5/16" (7.9 mm): 8, 10 mm (L=30 mm); AISI S2: 5/16" (7.9 mm): PH3, PH4 (L=30 mm); AISI S2: 5/16" (7.9 mm): PZ3, PZ4 (L=30 mm); AISI S2: 5/16" (7.9 mm): T40, T45, T50, T55, T60, T70 (L=30 mm); AISI S2: 5/16" (7.9 mm): T40, T45, T50, T55, T60, T70 (L=30 mm); AISI S2: 5/16" (7.9 mm): 10, 12, 14 mm (L=30 mm); AISI S2: 1/4" (6.3 mm): 3, 4, 5.5, 6.5, 7, 8, 9 mm (L=25 mm); AISI S2: 1/4" (6.3 mm): PH0, PH1, PH2, PH3 (L=25 mm); AISI S2: 1/4" (6.3 mm): PZ0, PZ1, PZ2, PZ3 (L=25 mm); AISI S2: 1/4" (6.3 mm): T8, T9, T10, T15, T20, T25, T27, T30 (L=25 mm); AISI S2: 1/4" (6.3 mm): T8, T9, T10, T15, T20, T25, T27, T30 (L=25 mm); AISI S2: 1/4" (6.3 mm): 3, 4, 5, 6, 7, 8 mm (L=25 mm); AISI S2: 1/4" (6.3 mm): 3, 4, 5, 6, 7, 8 mm (L=25 mm); AISI S2: 1/4" (6.3 mm): 4, 5, 6, 7, 8 mm (L=25 mm); AISI S2: 1/4" (6.3 mm): 1, 2, 3, 4 mm (L=25 mm); AISI S2: 1/4" (6.3 mm): 6, 8, 10 mm (L=25 mm); AISI S2: 1/4" (6.3 mm): 4, 6, 8, 10 mm (L=25 mm); AISI S2: 1/4" (6.3 mm): 8, 9, 10, 11, 12, 13, 14, 15, 17, 19, 22 mm; CrV: 6.5x38 mm, PH2x38 mm; SVC/M55: 180 mm; CrV 55: 250 mm; CrV: 2, 2.5, 3, 4, 5, 6, 7, 8, 10, 12 mm; CrV 6150

YATO	○	○	○	📦
YT-3894	1/2" (12.7 mm)	3/8" (9.5 mm)	1/4" (6.3 mm)	2

- GB Tool set
- D Sechskant-Steckschlüssel-Satz
- PL Zestaw narzędziowy
- RUS Набор инструментов
- CZ Sada nástrčných klíčů a ráčny
- H Dugókulcs készlet racsnis hajtókkal
- RO Rotrusa chei tubulare cu antrenor
- F Coffret d'outillage
- I Set di utensili
- E Juego de herramientas
- CN 套筒扳手组套



44 PCS	1/4" 6.3mm	⊖	⊕	⊗	⊙	⊚
		CrV		S2	SK2	



- ⌀6x7, 8x9, 10x11, 12x13, 14x15 mm;
- 1/4" (6.3 mm): 3, 4, 5, 5.5, 6 mm (L=25 mm); AISI S2;
- ⊕ 1/4" (6.3 mm): PH1, PH2, PH3 (L=25 mm); AISI S2;
- ⊗ 1/4" (6.3 mm): T8, T10, T15, T20, T25, T27 (L=25 mm); AISI S2;
- 1/4" (6.3 mm): 2, 2.5, 3, 4, 5, 6 mm (L=25 mm); AISI S2;
- ⌀160 mm; ⌀160 mm; ⌀200 mm; 300 g (L=300 mm);
- 3 m x 16 mm; 18 mm; SK2; 1/4" (6.3 mm); CrV;
- 5x75, 6x100, PH2x100 mm; S2; 1.5, 2, 2.5, 3, 4, 5, 6, 8, 10 mm; CrV 6150



NYLON BAG & COLOR BOX

YATO	○	
YT-39280	1/4" (6.3 mm)	4

- GB Tool set for electricians
- D Werkzeug-Set für Elektriker
- PL Zestaw narzędziowy dla elektryków
- RUS Набор инструментов для электриков
- CZ Sada nářadí pro elektrikáře
- H Szerszámkészlet villanyszerelők
- RO Set de instrumente pt. electricieni
- F Un ensemble d'outils pour les electriciens
- I Set per l'elettricista
- E Um conjunto de ferramentas para electricistas
- CN 件电子绝缘工具组套

BMC & COLOR SLEEVE



68 PCS	1/4" 6.3mm	CrV 50BV30	CrV 6150
		S2	1000 V
		DYE	



- 1/4" (6.3 mm): 4, 4.5, 5, 5.5, 6, 7, 8, 9, 10, 11, 12, 13 mm (L=25 mm); CrV 50BV30;
- ⌀140 mm; ⌀190 mm; 3CRB; ⌀150 mm;
- ⌀160 mm; 1000 V; CrV; ⌀160 mm; 1000 V; CrV;
- 3 m x 16 mm; 175 mm; 19.5 x 190 mm;
- 1.5 V; 9 LED; 9 mm; 19 mm x 20 m;
- 1/4" (6.3 mm); (150 mm); CrV 50BV30;
- 1/4" (6.3 mm) x 1/4" (6.3 mm); CrV 6140; □MM 10 g;
- 1.4, 2, 2.4 mm; PH00, PH0, PH1; S2;
- 4x75, 5.5x125, PH1x80, PH2x100 mm; 1000V; S2;
- 1/4" (6.3 mm): 3, 4, 5, 5.5, 6 mm (L=25 mm); AISI S2;
- ⊕ 1/4" (6.3 mm): PH1, PH2, PH3 (L=25 mm); AISI S2;
- ⊗ 1/4" (6.3 mm): T8, T10, T15, T20, T25, T27 (L=25 mm); AISI S2;
- 1/4" (6.3 mm): 2, 2.5, 3, 4, 5, 6 (L=25 mm); AISI S2;
- 1.5, 2, 2.5, 3, 4, 5, 6, 7, 8, 10 mm; CrV 6150



U 0-500 ~V	U 0-500 ~V	I 0-5 ~A	R 0-2 MΩ	⚡
		h _{FE} PNP NPN	5V _{P-P}	📶



12-250 V	50-500 Hz	LCD DISPLAY	NO BATTERY NEEDED NEPOTRZEBUJE BATERII
-------------	--------------	----------------	---



30W	230V~ 50Hz	400°C	TIP ⌀3.8x70 mm
-----	---------------	-------	-------------------

YATO	○	
YT-39009	1/4" (6.3 mm)	2

- GB Torx socket
- D Torx-Steckschlüssel
- PL Nasadka Torx
- RUS Головка
- CZ Nástavec Torx
- H Hatszögű rátét Torx
- RO Cheie tubulară Torx
- F Douille Torx
- I Bullone Torx
- E Boquilla Torx
- CN 星型套筒

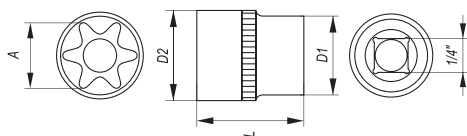

COLOR BOX



1/4"
6.3mm

TORX

CrV
50BV30

YATO	A (mm)	D1 (mm)	D2 (mm)	L (mm)	PCS packing	
YT-05211	E4	11.9	6.7	25	24	240/480
YT-05212	E5	11.9	7.2	25	24	240/480
YT-05213	E6	11.9	8.3	25	24	240/480
YT-05214	E7	11.9	9.4	25	24	240/480
YT-05215	E8	11.9	10.0	25	24	240/480

- GB Torx socket set
- D Torx-Steckschlüsselsatz
- PL Klucze nasadowe Torx
- RUS Набор роловок
- CZ Nástrčné klíče
- H Dugókulcs
- RO Trusa tubulară
- F Clés à tube
- I Chiavi a bussola bulloni Torx
- E Llaves de vaso
- CN 星型套筒组套



9
PCS

TORX

CrV
50BV30



- 1/4" (6.3 mm): E5, E6, E7, E8, 3/8" (9.5 mm): E10, E12, E14, E16;
- 1/4" (6.3 mm) (M) x 3/8" (9.5 mm) (F)

YATO		
YT-0520	1/4" (6.3 mm)	10/40

- GB Torx socket
- D Torx-Steckschlüssel
- PL Nasadka Torx
- RUS Головка
- CZ Nástavec Torx
- H Hatszögű rátét Torx
- RO Cheie tubulară Torx
- F Douille Torx
- I Bullone Torx
- E Boquilla Torx
- CN 星型套筒

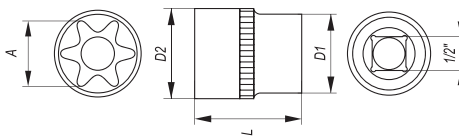

1/2"
12.5mm

TORX

CrV
50BV30

COLOR BOX



YATO	A (mm)	D1 (mm)	D2 (mm)	L (mm)	PCS packing	
YT-05220	E10	21.8	13.1	38	12	120/240
YT-05221	E11	21.8	13.9	38	12	120/240
YT-05222	E12	21.8	14.9	38	12	120/240
YT-05223	E14	21.8	16.3	38	12	120/240
YT-05224	E16	21.8	18.2	38	12	120/240

YATO	A (mm)	D1 (mm)	D2 (mm)	L (mm)	PCS packing	
YT-05225	E18	23.8	19.4	38	12	120/240
YT-05226	E20	21.8	23.9	38	12	120/240
YT-05227	E22	23.2	25.7	38	12	120/240
YT-05228	E24	23.8	27.8	38	12	60/120

- GB Torx socket set
- D Torx-Steckschlüsselsatz
- PL Klucze nasadowe Torx
- RUS Набор роловок
- CZ Nástrčné klíče
- H Dugókulcs
- RO Trusa tubulară
- F Clés à tube
- I Chiavi a bussola bulloni Torx
- E Llaves de vaso
- CN 星型套筒组套



9
PCS

TORX

CrV
50BV30

METAL CASE & COLOR SLEEVE



YATO		
YT-0521	1/2" (12.7 mm)	20

- GB Go-through socket set
- D Durchgangs-Knarrenkasten
- PL Zestaw nasadek przelotowych z grzechotką
- RUS Набор торцевых головок сквозных с трещоткой
- CZ Sada průchodných nástrčných klíčů

- H Dugókulcs készlet, csavarszár átengedős
- RO Set chei tubulară cu crichetă
- F Set de douilles à cliquet
- I Set chiavi a bussola con cricchetto

- E Juego de boquillas con orificio pasante, con carraca
- CN 套筒扳手组套

21
PCS

1/2"
12.5mm

1/4"
6.3mm

CrV
50BV30

CrV
6140

QUICK RELEASE SZYBKO-ZŁĄCZCE

METRIC METRYCZNE

IMPERIAL



- 10, 11, 12, 13, 14, 15, 16, 17, 18, 19 mm (L=32 mm);
- 3/8" (9.5 mm), 7/16" (11.1 mm), 1/2" (12.7 mm), 9/16" (14.3 mm),
- 5/8" (15.9 mm), 11/16" (17.5 mm), 3/4" (19.0 mm) (L=32 mm); CrV 50BV30;
- 1/2" (12.7 mm), 1/4" (6.3 mm); CrV 6140;
- 17 mm (L=75 mm); CrV 50BV30

YATO		
YT-3865	1/2" (12.7 mm)	1/4" (6.3 mm) 3/12

BMC & COLOR SLEEVE



- GB Hexagonal socket
- D Sechskantenschlüssel
- PL Nasadka sześciokątna
- RUS Головка шестигранная
- CZ Šestihranný nástavec
- H Hatszögű rátét
- RO Cheie tubulară hexagonală
- F Douille 6 pans
- I Chiave a bussola esagonale
- E Boquilla hexagonal
- CN 六角套筒

- application: industry, car service stations and workshops
- for high loads
- drive locks
- surface finish: chromed, satin
- przeznaczenie: przemysł, serwisy i warsztaty
- do największych obciążeń
- zamki blokujące
- wykończenie powierzchni: chromowana, satynowa

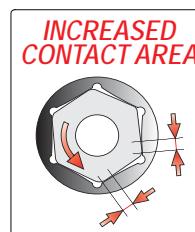
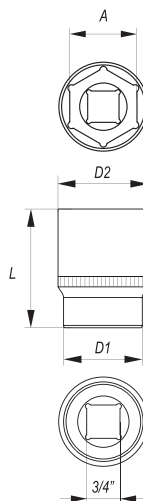

3/4"
19mm

DIN
3121

CrV
50BV30

AS-DRIVE

COLOR BOX



YATO	∅ A (mm)	D1 (mm)	D2 (mm)	L (mm)	PCS packing	
YT-1301	19	30	36	50	12	96
YT-1302	21	32	36	50	12	96
YT-1303	22	32	36	50	12	96
YT-1304	23	34	36	50	12	96
YT-1305	24	34	36	50	12	96
YT-1306	25	36	36	50	12	96
YT-1307	26	37	34	50	12	96
YT-1308	27	38	34	50	12	96
YT-1309	28	40	34	50	12	96
YT-1310	29	40	35	50	12	96
YT-1311	30	42	36	55	8	48
YT-1312	32	44	37	55	8	48
YT-1313	33	46	38	55	8	48

YATO	∅ A (mm)	D1 (mm)	D2 (mm)	L (mm)	PCS packing	
YT-1314	34	47	38	55	8	48
YT-1315	35	48	42	60	6	36
YT-1316	36	50	42	60	6	36
YT-1317	38	52	45	60	6	36
YT-1318	41	56	45	65	4	32
YT-1319	42	57	45	65	4	32
YT-1320	43	58	45	65	4	32
YT-1322	46	62	48	70	4	32
YT-1323	48	64	48	70	4	24
YT-1324	50	68	48	70	4	24
YT-1326	52	70	48	70	4	20
YT-1328	55	73	48	75	4	20
YT-1330	60	80	48	80	4	20

- GB Extension bar
- D Verlängerung
- PL Przedłużka
- RUS Удлинитель для воротка
- CZ Prodlužovací přípravek
- H Toldalék
- RO Prelungitor
- F Rallonge
- I Prolunga
- E Tubo de prolongación
- CN 接杆

3/4"
19mm

DIN
3121

CrV
50BV30

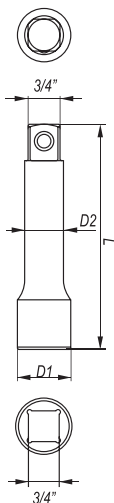

COLOR BOX

YATO	∅	D1 (mm)	D2 (mm)	L (mm)	PCS packing	
YT-1340	3/4" (19.0 mm)	36	22	100	6	36
YT-1341	3/4" (19.0 mm)	36	22	200	5	20
YT-1342	3/4" (19.0 mm)	36	22	400	5	10

- GB Sliding T-bar
- D Handgriff mit Gleitstück
- PL Pokrętko typu „T”
- RUS Вороток Т-образный
- CZ Otočná račká typ „T”
- H „T” alakú hajtókar
- RO Mâner clupă tipul „T”
- E Mango tipo „T”
- F Barre type „T”
- I Manopola „T” scorrevole
- CN 滑杆

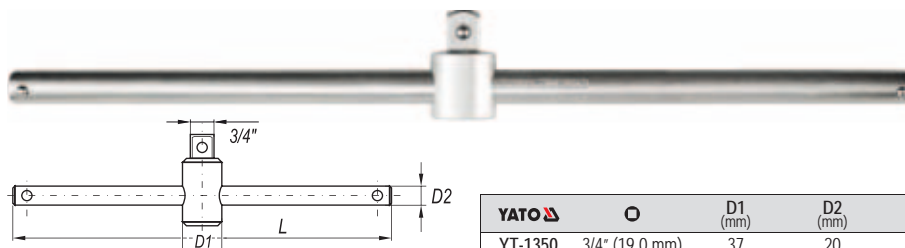

3/4"
19mm

DIN
3121

CrV
50BV30

COLOR BOX



YATO	∅	D1 (mm)	D2 (mm)	L (mm)	PCS packing	
YT-1350	3/4" (19.0 mm)	37	20	500	5	10

- GB Adapter
- D Reduktion
- PL Redukcja
- RUS Переходник
- CZ Redukce
- H Redució
- RO Reducție
- F Réduction
- I Riduttore
- E Reducción
- CN 转换头

3/4"
19mm

DIN
3121

CrV
50BV30

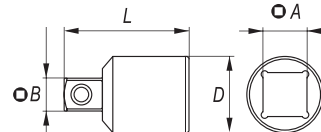

COLOR BOX



YATO	∅ A	∅ B	D (mm)	L (mm)	PCS packing	
YT-1355	3/4" (19.0 mm)	(F) 1/2" (12.7 mm)	(M) 36	53	12	48

- GB Universal joint
- D Kardangelen
- PL Przegub Cardana
- RUS Карданный шарнир
- CZ Kardanový kloub
- H Kárdán csukló
- RO Articulație Cardanică
- F Cardan
- I Snodo cardanico
- E Articulación Cardan
- CN 万向接头

3/4"
19mm

DIN
3121

CrV
50BV30

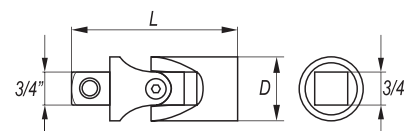

COLOR BOX



YATO	∅	D (mm)	L (mm)	PCS packing	
YT-1352	3/4" (19.0 mm)	40	106	12	36

- GB Flexible handle
- D Gelenkgriff
- PL Pokrętko łamane
- RUS Вороток шарнирный
- CZ Otočná lomená rączka
- H Hajlított hajtókar
- RO Prelungitor cu prindere flexibilă
- F Barre pivotante
- I Manopola a snodo
- E Mango articulado
- CN 转向手柄

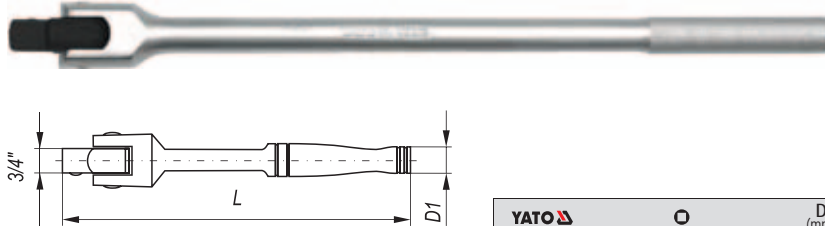

3/4"
19mm

DIN
3121

CrV
50BV30

COLOR BOX



YATO 	Ø	D (mm)	L (mm)	PCS packing	
YT-1345	3/4" (19.0 mm)	25	507	5	10

- GB L-type handle
- D Admutterenschlüssel
- PL Pokrętko typu „L”
- RUS Вороток 1/2" тип „L”
- CZ Páka zahnutá
- H „L” alakú hajtókar
- RO Măner clupă tipul „L”
- F Barre type „L”
- I Leva tipo „L”
- E Mango tipo „L”
- CN L型套筒扳手





3/4"
19mm

DIN
3121

CrV
50BV30

COLOR BOX



YATO 	Ø	D (mm)	L (mm)	PCS packing	
YT-1347	3/4" (19.0 mm)	25	385	5	10
YT-1348	3/4" (19.0 mm)	25	440	5	10

- GB Quick release ratchet handle
- D Hebelumschaltknarre
- PL Grzechotka
- RUS Трещотка
- CZ Řehtačka
- H Racsnis hajtókar
- RO Dispozitiv de prindere cu clichet
- F Clé à cliquet
- I Cricchetto bussola
- E Carraca
- CN 快速脱落棘轮扳手



3/4"
19mm

DIN
3122

24T

CrV
6140

QUICK RELEASE
SZYBKO-ZŁĄCZCE

COLOR BOX



YATO 	Ø	T	L (mm)	
YT-1360	3/4" (19.0 mm)	24	625	10

- GB Socket set
- D Sechskant-Steckschlüssel-Satz
- PL Komplet nasadek z akcesoriami
- RUS Набор насадок
- CZ Sada nástrčných kličů a ráčny
- H Dugókulcs készlet racsnis hajtókarral

- RO Rotrușă de tubulare cu antrenor
- F Clé à cliquet
- I Cricchetto bussola
- E Juego de boquillas con accesorios
- CN 套筒扳手机组套



3/4"
19mm





CrV
50BV30

CrV
6140

QUICK RELEASE
SZYBKO-ZŁĄCZCE



24T



3/4" (19.0 mm): 30, 32, 34 (L=55 mm); 36, 38 (L=60 mm); 41 (L=65 mm); 46, 50 (L=70 mm); 55 (L=75 mm); 60 mm (L=80 mm); CrV 50BV30;  3/4" (19.0 mm); (L=500 mm); 24T; CrV 6140;  3/4" (19.0 mm); (L=500 mm); CrV 50BV30;  3/4" (19.0 mm); (L=100, 200 mm); CrV 50BV30;  3/4" (19.0 mm); (L=106 mm); CrV 50BV30

15
PCS

YATO 	Ø	
YT-1334	3/4" (19.0 mm)	1

3/4" (19.0 mm): 19, 21, 22, 24 mm (L=50 mm); 26, 27, 28 mm (L=52 mm); 30, 32 mm (L=53 mm); 33, 34 mm (L=56 mm); 36 mm (L=58 mm); 38 mm (L=60 mm); 41 mm (L=64 mm); 46 mm (L=68 mm); 50 mm (L=72 mm); CrV 50BV30;  3/4" (19.0 mm) x 620 mm; CrV 6140;  3/4" (19.0 mm); (L=500 mm); CrV 50BV30;  3/4" (19.0 mm) x 100 mm; 3/4" (19.0 mm) x 200 mm; CrV 50BV30

20
PCS

YATO 	Ø	
YT-1335	3/4" (19.0 mm)	1

- GB Star bit sockets
 D Aufsteckschlüssel
 PL Klucze trzpieniowe
 RUS Набор головок-вставок
 CZ Šerové klíče
 H Csapkulcs
- RO Chei cu cozi
 F Douille tournevis
 I Chiavi a bussola
 E Llaves de mandril
 CN 星型旋具套筒



PLASTIC HANGER



1/4"
6.3mm
AISI S2
CrV 6150
HRC 58-62
DIN 3120

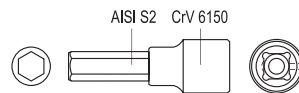
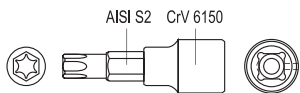

YATO	Ø	☆	L (mm)	torque / moment obrotowy max. (Nm)	📦
YT-04301	1/4" (6.3 mm)	T8	37	2.6	150/600
YT-04302	1/4" (6.3 mm)	T10	37	4.6	150/600
YT-04303	1/4" (6.3 mm)	T15	37	7.7	150/600
YT-04304	1/4" (6.3 mm)	T20	37	12.7	150/600
YT-04305	1/4" (6.3 mm)	T25	37	19.0	150/600
YT-04306	1/4" (6.3 mm)	T30	37	37.4	150/600
YT-04307	1/4" (6.3 mm)	T40	37	65.0	150/600

YATO	Ø	☆	L (mm)	torque / moment obrotowy max. (Nm)	📦
YT-04370	1/4" (6.3 mm)	3	37	6.6	150/600
YT-04371	1/4" (6.3 mm)	4	37	16.0	150/600
YT-04372	1/4" (6.3 mm)	5	37	30.0	150/600
YT-04373	1/4" (6.3 mm)	6	37	52.2	150/600
YT-04374	1/4" (6.3 mm)	7	37	78.0	150/600
YT-04375	1/4" (6.3 mm)	8	37	120.0	150/600

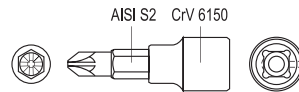
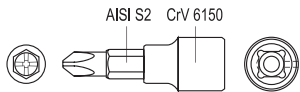

YATO	Ø	⊕	L (mm)	torque / moment obrotowy max. (Nm)	📦
YT-04411	1/4" (6.3 mm)	PH1	37	3.5	150/600
YT-04412	1/4" (6.3 mm)	PH2	37	8.2	150/600
YT-04413	1/4" (6.3 mm)	PH3	37	19.5	150/600

YATO	Ø	⊕	L (mm)	torque / moment obrotowy max. (Nm)	📦
YT-04417	1/4" (6.3 mm)	PZ1	37	3.5	150/600
YT-04418	1/4" (6.3 mm)	PZ2	37	8.2	150/600

- GB Insulated star bit socket
 D Aufsteckschlüssel vollisoliert
 PL Klucze trzpieniowe izolowane
 RUS Головка торцевая с вставкой hex изолированная
 CZ Šerové klíče izolované
 H Csapkulcs
 RO Chei cu cozi izolat
 F Douille tournevis isolée
 I Chiave esagonale isolato
 E Llaves de mandril aislante
 CN 绝缘套筒批

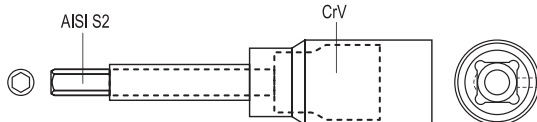

3/8"
10mm
CrV
1000 V
D+E

1000V
VDE CERTIFICATE
EN 60900:2012

YATO	Ø	☆	L (mm)	torque / moment obrotowy max. (Nm)	📦
YT-21080	3/8" (9.5 mm)	4	75	16.0	12/144
YT-21081	3/8" (9.5 mm)	5	75	30.0	12/144
YT-21082	3/8" (9.5 mm)	6	75	52.0	12/144
YT-21083	3/8" (9.5 mm)	8	75	120.0	12/144

- GB Star bit sockets
 D Aufsteckschlüssel
 PL Klucze trzpieniowe
 RUS Набор головок-вставок
 CZ Šerové klíče
 H Csapkulcs
- RO Chei cu cozi
 F Douille tournevis
 I Chiavi a bussola
 E Llaves de mandril
 CN 星型旋具套筒



PLASTIC HANGER



1/2"
12.5mm
AISI S2
CrV 6150
HRC 58-62
DIN 3120

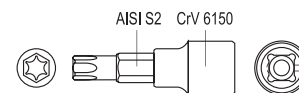
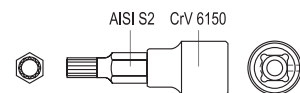
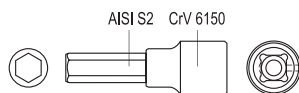

YATO	Ø	☆	L (mm)	torque / moment obrotowy max. (Nm)	📦
YT-04381	1/2" (12.7 mm)	5	55	30.0	40/240
YT-04382	1/2" (12.7 mm)	6	55	52.0	40/240
YT-04383	1/2" (12.7 mm)	7	55	78.0	40/240
YT-04384	1/2" (12.7 mm)	8	55	120.0	40/240
YT-04385	1/2" (12.7 mm)	10	55	220.0	40/160
YT-04386	1/2" (12.7 mm)	12	55	370.0	40/160
YT-04387	1/2" (12.7 mm)	14	55	590.0	40/160
YT-04388	1/2" (12.7 mm)	17	55	1000.0	40/160

YATO	Ø	☆	L (mm)	torque / moment obrotowy max. (Nm)	📦
YT-04341	1/2" (12.7 mm)	M6	55	30.0	40/240
YT-04342	1/2" (12.7 mm)	M8	55	52.0	40/240
YT-04343	1/2" (12.7 mm)	M10	55	120.0	40/160
YT-04344	1/2" (12.7 mm)	M12	55	220.0	40/160
YT-04345	1/2" (12.7 mm)	M14	55	370.0	40/160
YT-04346	1/2" (12.7 mm)	M16	55	590.0	40/160

YATO	Ø	☆	L (mm)	torque / moment obrotowy max. (Nm)	📦
YT-04310	1/2" (12.7 mm)	T20	55	12.7	40/240
YT-04311	1/2" (12.7 mm)	T25	55	19.0	40/240
YT-04312	1/2" (12.7 mm)	T27	55	27.0	40/240
YT-04313	1/2" (12.7 mm)	T30	55	37.4	40/240
YT-04314	1/2" (12.7 mm)	T40	55	65.0	40/240
YT-04315	1/2" (12.7 mm)	T45	55	103.5	40/240
YT-04316	1/2" (12.7 mm)	T50	55	159.0	40/240
YT-04317	1/2" (12.7 mm)	T55	55	257.0	40/240
YT-04318	1/2" (12.7 mm)	T60	55	445.0	40/240
YT-04319	1/2" (12.7 mm)	T70	55	700.0	40/160

- GB Star bit sockets
D Aufsteckschlüssel
PL Klucze trzpieniowe
RUS Набор головок-вставок
CZ Čepové klíče
H Csapkulcs
- RO Chei cu cozi
F Douille tournevis
I Chiavi a bussola
E Llaves de mandril
CN 星型旋具套筒



PLASTIC HANGER



1/2"	AISI S2
12.5mm	
CrV 6150	HRC 58-62
	DIN 3120

2

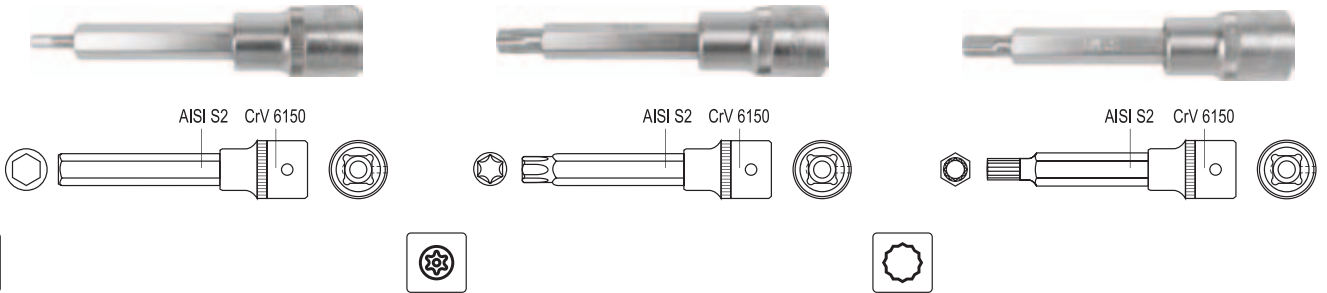

YATO	Ø	⊘ L (mm)	torque / moment obrotowy max. (Nm)	⊠
YT-04390	1/2" (12.7 mm)	4	100	16.0 20/120
YT-04391	1/2" (12.7 mm)	5	100	30.0 20/120
YT-04392	1/2" (12.7 mm)	6	100	52.0 20/120
YT-04393	1/2" (12.7 mm)	7	100	78.0 20/120
YT-04394	1/2" (12.7 mm)	8	100	120.0 20/120
YT-04395	1/2" (12.7 mm)	10	100	220.0 20/120
YT-04396	1/2" (12.7 mm)	12	100	370.0 20/120
YT-04397	1/2" (12.7 mm)	14	100	590.0 20/120
YT-04398	1/2" (12.7 mm)	17	100	1000.0 20/120

YATO	Ø	⊘ L (mm)	torque / moment obrotowy max. (Nm)	⊠
YT-04320	1/2" (12.7 mm)	T20	100	12.7 20/120
YT-04321	1/2" (12.7 mm)	T25	100	19.0 20/120
YT-04322	1/2" (12.7 mm)	T27	100	27.0 20/120
YT-04323	1/2" (12.7 mm)	T30	100	37.4 20/120
YT-04324	1/2" (12.7 mm)	T40	100	65.0 20/120
YT-04325	1/2" (12.7 mm)	T45	100	103.5 20/120
YT-04326	1/2" (12.7 mm)	T50	100	159.0 20/120
YT-04327	1/2" (12.7 mm)	T55	100	257.0 20/120
YT-04328	1/2" (12.7 mm)	T60	100	445.0 20/120
YT-04329	1/2" (12.7 mm)	T70	100	700.0 20/120

YATO	Ø	⊘ L (mm)	torque / moment obrotowy max. (Nm)	⊠
YT-04350	1/2" (12.7 mm)	M5	100	16.0 20/120
YT-04351	1/2" (12.7 mm)	M6	100	30.0 20/120
YT-04352	1/2" (12.7 mm)	M8	100	52.0 20/120
YT-04353	1/2" (12.7 mm)	M10	100	120.0 20/120
YT-04354	1/2" (12.7 mm)	M12	100	220.0 20/120
YT-04355	1/2" (12.7 mm)	M14	100	370.0 20/120
YT-04356	1/2" (12.7 mm)	M16	100	590.0 20/120
YT-04357	1/2" (12.7 mm)	M17	100	590.0 20/120

- GB Insulated star bit socket
D Aufsteckschlüssel vollisoliert
PL Klucze trzpieniowe izolowane
RUS Головка торцевая с вставкой hex изолированная
CZ Čepové klíče izolované
H Csapkulcs
RO Chei cu cozi izolat
F Douille tournevis isolée
I Chiave esagonale isolato
E Llaves de mandril aislante
CN 绝缘套筒批

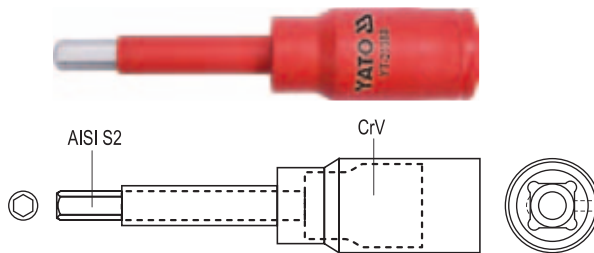

1/2"	⊠	CrV	1000 V	D'E
12.5mm				

1000V
VDE CERTIFICATE
EN 60900:2012

YATO	Ø	⊘ L (mm)	torque / moment obrotowy max. (Nm)	⊠
YT-21085	1/2" (12.7 mm)	4	120	16.0 18/144
YT-21086	1/2" (12.7 mm)	5	120	30.0 18/144
YT-21087	1/2" (12.7 mm)	6	120	52.0 18/144
YT-21088	1/2" (12.7 mm)	8	120	120.0 18/144
YT-21089	1/2" (12.7 mm)	10	120	220.0 18/144

- GB Star bit sockets
D Aufsteckschlüssel
PL Klucze trzpieniowe
RUS Набор головок-вставок
CZ Čepové klíče
H Csapkulcs
- RO Chei cu cozi
F Douille tournevis
I Chiavi a bussola
E Llaves de mandril
CN 星型旋具套筒



SLIDING CARD



1/4"	3/8"	AISI S2	CrV 6150
6.3mm	10mm		
		HRC 58-62	DIN 3120



12 PCS TORX

1/4" (6.3 mm): L=37 mm: T8, T10, T15, T20, T25, T27, T30
3/8" (9.5 mm): L=48 mm: T40, T45, T47, T50, T55

12 PCS TORX TAMPERPROOF

1/4" (6.3 mm): L=37 mm: T8, T10, T15, T20, T25, T27, T30
3/8" (9.5 mm): L=48 mm: T40, T45, T47, T50, T55

YATO	⊠	YT-04331	10/40
------	---	----------	-------

YATO	⊠	YT-04332	10/40
------	---	----------	-------



9 PCS HEX

1/4" (6.3 mm): L=37 mm: H2, H3, H4, H5, H6
3/8" (9.5 mm): L=48 mm: H7, H8, H10, H12

5 PCS SPLINE

1/4" (6.3 mm): L=37 mm: M5, M6
3/8" (9.5 mm): L=48 mm: M8, M10, M12

YATO	⊠	YT-04401	6/36
------	---	----------	------

YATO	⊠	YT-04360	12/48
------	---	----------	-------

- GB Star bit sockets
- D Aufsteckschlüssel
- PL Klucze trzpieniowe
- RUS Набор головок-вставок
- CZ Čepové klíče
- H Csapkulcs
- RO Chei cu cozi
- F Douille tournevis
- I Chiavi a bussola
- E Llaves de mandril
- CN 星型旋具套筒



AISI S2
CrV 6150



7 PCS	1/4" 6.3mm	DIN 3120	TORX SPECIAL TAMPERPROOF
21.8 Nm max.	AISI S2	HRC 58-62	TOYOTA VW

1/4" (6.3 mm): L=35 mm; TS10, TS15, TS20, TS25, TS27, TS30, TS40

YATO		
YT-0461		12/48

- GB Bit socket set
- CZ Čepové klíče
- I Chiavi a bussola a vite
- D Aufsteckschlüssel-Satz
- H Csapkulcs
- E Juego de llaves de mandril
- PL Zestaw kluczy trzpieniowych
- RO Chei cu cozi
- CN 套筒批头组套
- RUS Набор головок-вставок
- F Set de douilles tournevis



18 PCS	1/2" 12.5mm	1/4" 6.3mm
CrV 6150	HRC 58-62	
AISI S2	DIN 3120	



1/2" (12.7 mm): T30, T40, T45, T50, T55, T60 (L=50 mm);
T30, T40, T45, T50, T55, T60 (L=100 mm); AISI S2 / CrV 6150;
1/4" (6.3 mm): T10, T15, T20, T25, T30, T40 (L=37 mm); AISI S2 / CrV 6150

YATO			
YT-7751	1/2" (12.7 mm)	1/4" (6.3 mm)	10



1/2" (12.7 mm): 5, 6, 7, 8, 10, 12 mm (L=50 mm);
5, 6, 7, 8, 10, 12 mm (L=100 mm); AISI S2 / CrV 6150;
1/4" (6.3 mm): 3, 4, 5, 6, 7, 8 mm (L=37 mm); AISI S2 / CrV 6150

YATO			
YT-7752	1/2" (12.7 mm)	1/4" (6.3 mm)	10

- GB Bit socket set
- CZ Čepové klíče
- I Chiavi a bussola a vite
- D Aufsteckschlüssel-Satz
- H Csapkulcs
- E Juego de llaves de mandril
- PL Zestaw kluczy trzpieniowych
- RO Chei cu cozi
- CN 套筒批头组套
- RUS Набор головок-вставок
- F Set de douilles tournevis



12 PCS	1/2" 12.5mm	CrV 6150
HRC 58-62	AISI S2	
	DIN 3120	



1/2" (12.7 mm): M12, M17 (L=50 mm); M6 (L=70 mm); M7, M8 (L=100 mm);
M8, M10 (L=120 mm); M6, M10, M12 (L=140 mm); M5 (L=180 mm);
M6 (L=250 mm); AISI S2 / CrV 6150

YATO			
YT-7753	1/2" (12.7 mm)		10

Memo

3

**Impact sockets,
accessories & sets**

**Udarowe klucze nasadowe,
akcesoria i zestawy**



Impact sockets 3/8"
Klucze nasadowe udarowe 3/8"

80



Impact sockets 1"
Udarowe klucze nasadowe 1"

85



Impact sockets sets

Zestawy kluczy nasadowych udarowych krótkich..... 80

Impact sockets

Klucze nasadowe udarowe, krótkie..... 85

Deep impact sockets

Klucze nasadowe udarowe, długie..... 85

Impact sockets 1/2"

Klucze nasadowe udarowe 1/2"

80-81



Impact accessories 1"

Akcesoria udarowe 1"

85



Impact sockets & sets

Klucze nasadowe udarowe i zestawy, krótkie..... 80

Deep impact sockets & sets

Klucze nasadowe udarowe i zestawy, długie..... 81

Impact extension bars with adapter

Przedłużki udarowe z redukcją..... 85

Impact accessories 1/2"

Akcesoria udarowe 1/2"

82



Impact sockets for front hub nuts

Nasadki udarowe do piast

86



Impact extension bars

Przedłużki udarowe..... 82

Impact adapters

Redukcje udarowe..... 82

Impact universal joints

Przeguby kuliste udarowe..... 82

Impact bit socket sets 1/2"

Zestawy udarowych kluczy trzpieniowych 1/2"

86



Impact sockets 3/4"

Udarowe klucze nasadowe 3/4"

83-84



Spline impact bit sets 3/4"

Zestawy bitów udarowych „Spline” 3/4"

86



Impact sockets & sets

Klucze nasadowe udarowe i zestawy, krótkie..... 83

Deep impact sockets & sets

Klucze nasadowe udarowe i zestawy, długie..... 83

Impact accessories 3/4"

Akcesoria udarowe 3/4"

84



Impact extension bars

Przedłużki udarowe..... 84

Impact adapters

Redukcje udarowe..... 84

Impact universal joints

Przeguby kuliste udarowe..... 84

GB Impact socket set
D Kraftschrauber-Einsätze
PL Zestaw nasadek udarowych
RUS Набор торцевых ударных головок

CZ Sada nástrčných klíčů pro úderové utahováky
H Dugófej készlet ütvebehajtóhoz
RO Set chei tubulare pt. impact
F Douille profonde à choc

I Chiave a bussola esagonale per percussione
E Juego de boquillas de percusión cortas
CN 风动套筒组套

METAL CASE & COLOR BOX



10 PCS 3/8" 10mm CrMo SCM-440



3/8" (9.5 mm): 10, 12, 13, 14, 15, 16, 17, 18, 19, 22 mm (L=39 mm)

YATO	○	
YT-37690	3/8" (9.5 mm)	20

GB Hexagonal impact socket
D Kraftschrauber-Einsatz
PL Nasadka udarowa sześciokątna
RUS Головка ударная 6-гранная
CZ Šestihranný nástavec
H Hatszögű rátét
RO Cheie tubulară hexagonală de impact
F Douille à choc
I Chiave a bussola esagonale per percussione
E Boquilla de percusión
CN 六角风动套筒

COLOR BOX



1/2" 12.5mm CrMo SCM-440

AS-DRIVE

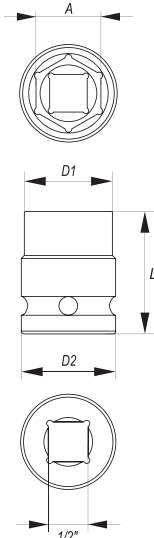

YATO	○ A (mm)	D1 (mm)	D2 (mm)	L (mm)	PCS packing:	
YT-1000	10	17.5	25.0	39	60	240
YT-1001	11	18.5	25.0	39	60	240
YT-1002	12	20.0	25.0	39	60	240
YT-1003	13	21.0	25.0	39	60	240
YT-1004	14	22.5	25.0	39	60	240
YT-1005	15	23.5	30.0	39	40	160
YT-1006	16	24.0	30.0	39	40	160
YT-1007	17	26.0	30.0	39	40	160
YT-1008	18	27.5	30.0	39	40	160
YT-1009	19	28.0	30.0	39	40	160
YT-1010	20	30.0	30.0	39	40	160
YT-1011	21	30.0	30.0	39	40	160
YT-1012	22	32.0	30.0	39	30	120
YT-1013	23	32.0	30.0	39	30	120
YT-1014	24	34.0	30.0	43	30	120
YT-1015	25	35.0	30.0	43	30	120
YT-1016	26	38.0	30.0	43	24	96
YT-1017	27	38.0	30.0	43	24	96
YT-1018	28	40.0	30.0	48	24	96
YT-1019	29	41.0	30.0	48	22	88
YT-1020	30	42.0	30.0	48	24	96
YT-1022	32	44.0	30.0	48	20	80

GB Impact socket set
D Kraftschrauber-Einsätze
PL Zestaw nasadek udarowych
RUS Набор торцевых ударных головок

CZ Sada nástrčných klíčů pro úderové utahováky
H Dugófej készlet ütvebehajtóhoz
RO Set chei tubulare pt. impact
F Set de douilles à choc

I Chiave a bussola esagonale per percussione
E Juego de boquillas de percusión cortas
CN 风动套筒组套

METAL CASE & COLOR BOX



10 PCS 1/2" 12.5mm CrMo SCM-440

AS-DRIVE



1/2" (12.7 mm): 10, 12, 13, 14, 15, 16, 17, 18, 19, 22 mm (L=39 mm)

YATO	○	
YT-1025	1/2" (12.7 mm)	20

- GB Hexagonal deep impact socket
D Kraftschrauber-Einsatz, lang
PL Nasadka udarowa sześciokątna długa
RUS Головка ударная 6-гранная глубокая
CZ Šestihranný hluboký nástavec
H Hatszögű rátét mély
RO Cheie tubulară hexagonală de impact adâncă
F Douille profonde à choc
I Chiave a bussola esagonale per percussione
E Boquilla de percusión profunda
CN 六角风动长套筒

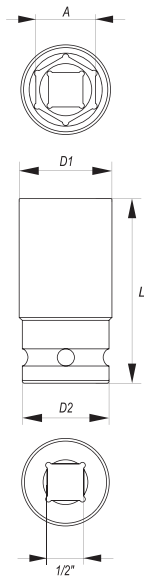



COLOR BOX



1/2"
12.5mm

CrMo
SCM-440

AS-DRIVE

YATO 	∅ A (mm)	D1 (mm)	D2 (mm)	L (mm)	PCS packing:	
YT-1030	10	17.5	24.0	78	30	120
YT-1031	11	18.5	24.0	78	30	120
YT-1032	12	20.0	24.0	78	30	120
YT-1033	13	21.0	24.0	78	30	120
YT-1034	14	22.0	24.0	78	30	120
YT-1035	15	23.7	24.0	78	30	120
YT-1036	16	24.0	24.0	78	30	120
YT-1037	17	26.0	26.0	78	25	100
YT-1038	18	28.0	28.0	78	24	96
YT-1039	19	28.0	28.0	78	24	96
YT-1040	20	30.0	30.0	78	20	80
YT-1041	21	30.0	30.0	78	20	80
YT-1042	22	32.0	30.0	78	18	72
YT-1043	23	32.0	30.0	78	15	60
YT-1044	24	34.0	30.0	78	15	60
YT-1045	25	35.0	30.0	78	15	60
YT-1046	26	38.0	30.0	78	12	48
YT-1047	27	38.0	30.0	78	12	48
YT-1048	28	40.0	30.0	78	12	48
YT-1049	29	41.0	30.0	78	10	40
YT-1050	30	42.0	30.0	78	10	40
YT-1052	32	44.0	30.0	78	10	40

3

- GB Impact socket set
D Kraftschrauber-Einsätze
PL Zestaw nasadek udarowych
RUS Набор торцевых ударных головок
CZ Sada nástrčných klíčů pro úderové utahováky
H Dugófej készlet ütvebehajtóhoz
- RO Set chei tubulare pt. impact
F Set de douilles à choc
I Chiave a bussola esagonale per percussione
E Juego de boquillas de percusión cortas
CN 风动套筒组套

METAL CASE & COLOR BOX



1/2"
12.5mm



CrMo
SCM-440

AS-DRIVE



11
PCS



1/2" (12.7 mm): 10, 12, 13, 14, 15, 16, 17, 18, 19, 22, 24 mm (L=39 mm)

YATO 	∅	
YT-1054	1/2" (12.7 mm)	10



15
PCS



1/2" (12.7 mm): 10, 12, 13, 14, 15, 16, 17, 18, 19, 21, 22, 24, 27, 30, 32 mm (L=39 mm)

YATO 	∅	
YT-1055	1/2" (12.7 mm)	4

- GB Impact extension bar
- D Verlängerung
- PL Przedłużka uderowa
- RUS Удлинитель ударный
- CZ Prodlužovací příravek
- H Toldalék
- RO Prelungitor
- F Rallonge
- I Prolunga per percussione
- E Tubo de prolongación
- CN 风动接杆

1/2"
12.5mm CrMo SCM-440



YATO 	Ø	D1 (mm)	D2 (mm)	L (mm)	PCS packing	
YT-1060	1/2" (12.7 mm)	17.5	25.0	75	40	160
YT-1061	1/2" (12.7 mm)	18.5	25.0	125	28	112
YT-1062	1/2" (12.7 mm)	20.0	25.0	250	30	60

- GB Impact adapter
- D Reduktion
- PL Redukcja uderowa
- RUS Переходник
- CZ Redukce
- H Redukció
- RO Reducție
- F Réduction
- I Prolunga per percussione
- E Reducción
- CN 风动转换头

1/2"
12.5mm CrMo SCM-440



YATO 	Ø	Ø	D (mm)	L (mm)	PCS packing	
YT-1067	1/2" (12.7 mm) (F)	3/4" (19.0 mm) (M)	30	48	40	160

- GB Impact universal joint
- D Gelenkstück
- PL Przegub kulisty uderowy
- RUS Кардан ударный
- CZ Kloub kulový
- H Univerzális csuklós csatlakozó
- RO Adaptor
- F Flector rond
- I Prolunga per percussione
- E Articulación redonda
- CN 风动万向接头

1/2"
12.5mm CrMo SCM-440



YATO 	Ø	D1 (mm)	D2 (mm)	L (mm)	PCS packing	
YT-1064	1/2" (12.7 mm)	31	17	63	25	100



- GB Hexagonal impact socket
D Kraftschrauber-Einsatz
PL Nasadka udarowa sześciokątna
RUS Головка ударная 6-гранная
CZ Šestihranný nástavec
H Hatszögű rátét
RO Cheie tubulară hexagonală de impact
F Douille à choc
I Chiave a bussola esagonale per percussione
E Boquilla de percusión
CN 六角风动套筒

COLOR BOX

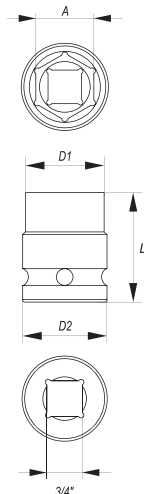

3/4"
19mm
CrMo
SCM-440
AS-DRIVE



YATO 	∅ A (mm)	D1 (mm)	D2 (mm)	L (mm)	PCS packing:	
YT-1070	19	32	40	50	16	64
YT-1071	21	35	40	50	16	64
YT-1072	22	38	40	50	16	64
YT-1073	23	38	40	50	16	64
YT-1074	24	40	40	50	16	64
YT-1075	25	40	40	50	16	64
YT-1076	26	40	40	50	16	64
YT-1077	27	42	42	53	16	64
YT-1078	28	44	44	53	16	64
YT-1079	29	46	44	53	12	48
YT-1080	30	46	44	53	12	48
YT-1082	32	48	44	56	12	48
YT-1083	33	48	44	56	8	32
YT-1084	34	50	44	56	8	32
YT-1085	35	50	44	56	6	24
YT-1086	36	52	44	56	6	24
YT-1088	38	56	44	57	6	24
YT-1091	41	60	44	57	5	20
YT-1092	42	61	44	57	4	16
YT-1093	43	63	44	57	4	16
YT-1096	46	66	44	62	3	12
YT-1100	50	71	54	72	3	12
YT-1102	52	74	54	72	2	8
YT-1105	55	78	54	74	2	8
YT-1110	60	84	54	74	2	8

- GB Impact socket set
D Kraftschrauber-Einsätze
PL Zestaw nasadek udarowych
RUS Набор торцевых ударных головок
CZ Sada nástrčných klíčů pro úderové utahováky
H Dugófej készlet ütvebehajtóhoz
- RO Set chei tubulare pt. impact
F Set de douilles à choc
I Chiave a bussola esagonale per percussione
E Juego de boquillas de percusión cortas
CN 风动套筒组套



8
PCS
3/4"
19mm
CrMo
SCM-440
AS-DRIVE

METAL CASE & COLOR BOX



3/4" (19.0 mm): 22, 24 mm (L=50 mm); 27, 30 mm (L=53 mm);
32, 36 mm (L=55 mm); 38, 41 mm (L=57 mm)

YATO 	∅	
YT-1115	3/4" (19.0 mm)	6



- GB Hexagonal deep impact socket
D Kraftschrauber-Einsatz, lang
PL Nasadka udarowa sześciokątna długa
RUS Головка ударная 6-гранная глубокая
CZ Šestihranný hluboký nástavec
H Hatszögű rátét mély
RO Cheie tubulară hexagonală de impact adâncă
- F Douille profonde à choc
I Chiave a bussola esagonale per percussione
E Boquilla de percusión profunda
CN 六角风动长套筒

COLOR BOX

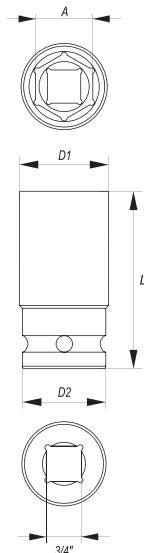

3/4"
19mm
CrMo
SCM-440
AS-DRIVE



YATO 	∅ A (mm)	D1 (mm)	D2 (mm)	L (mm)	PCS packing:	
YT-1119	19	32	44	90	9	36
YT-1121	21	35	44	90	9	36
YT-1122	22	38	44	90	9	36
YT-1123	23	38	44	90	9	36
YT-1124	24	40	44	90	9	36
YT-1127	27	42	44	90	9	36
YT-1128	28	44	44	90	8	32
YT-1129	29	44	44	90	8	32
YT-1130	30	46	44	90	7	28
YT-1132	32	48	44	90	7	28
YT-1133	33	50	44	90	6	24
YT-1134	34	51	44	90	6	24
YT-1135	35	52	44	90	6	24
YT-1136	36	54	44	90	6	24
YT-1138	38	56	44	90	6	24
YT-1141	41	60	44	90	5	20
YT-1142	42	61	44	90	4	16
YT-1143	43	63	44	90	3	12
YT-1146	46	66	44	90	3	12
YT-1148	48	68	44	90	2	8
YT-1150	50	71	54	90	2	8

GB Impact socket set
D Kraftschrauber-Einsätze
PL Zestaw nasadek udarowych
RUS Набор торцевых ударных головок

CZ Sada nástrčných klíčů pro úderové utahovky
H Dugófej készlet ütvebehajtóhoz
RO Set chei tubulare pt. impact
F Douille profonde à choc

I Chiave a bussola esagonale per percussione
E Juego de boquillas de percusión cortas
CN 风动长套筒组套



8 PCS
3/4" 19mm
CrMo SCM-440
AS-DRIVE



3/4" (19.0 mm): 22, 24, 27, 30, 32, 36, 38, 41 mm (L=90 mm)

YATO	○	
YT-1155	3/4" (19.0 mm)	4

GB Impact extension bar
D Verlängerung
PL Przedłużka udarowa
RUS Удлинитель ударный
CZ Prodlužovací přípravek
H Toldalék
RO Prelungitor
F Rallonge
I Prolunga per percussione
E Tubo de prolongación
CN 风动接杆

3/4" 19mm
CrMo SCM-440

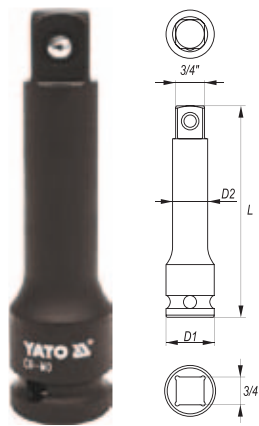

COLOR BOX



YATO	○	D1 (mm)	D2 (mm)	L (mm)	PCS packing:	
YT-1160	3/4" (19.0 mm)	44	24	100	8	32
YT-1161	3/4" (19.0 mm)	44	24	175	10	20
YT-1162	3/4" (19.0 mm)	44	24	250	8	16
YT-1163	3/4" (19.0 mm)	44	24	330	6	12

GB Impact adapter
D Reduktion
PL Redukcja udarowa
RUS Переходник
CZ Redukce
H Redukció
RO Reducție

F Réduction
I Prolunga per percussione
E Reducción
CN 风动转换头

3/4" 19mm
CrMo SCM-440

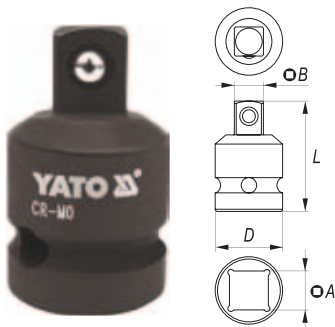

COLOR BOX



YATO	○	○	D (mm)	L (mm)	PCS packing:	
YT-1168	3/4" (19.0 mm) (F)	1" (25.4 mm) (M)	44	63	12	48

GB Impact adapter
D Reduktion
PL Redukcja udarowa
RUS Переходник
CZ Redukce
H Redukció
RO Reducție

F Réduction
I Prolunga per percussione
E Reducción
CN 风动转换头

3/4" 19mm
CrV 50BV30



COLOR BOX



YATO	○	○	D (mm)	L (mm)	PCS packing:	
YT-11671	3/4" (19.0 mm) (F)	1/2" (12.7 mm) (M)	44	55	12	48

GB Impact universal joint
D Gelenkstück
PL Przegub kulisty udarowy
RUS Кардан ударный
CZ Kloub kulový
H Univerzális csuklós csatlakozó
RO Adaptor
F Flector rond
I Prolunga per percussione
E Articulación redonda
CN 风动方向接头

3/4" 19mm
CrMo SCM-440



COLOR BOX



YATO	○	D1 (mm)	D2 (mm)	L (mm)	PCS packing:	
YT-1164	3/4" (19.0 mm)	31	44	102	8	32

- GB Hexagonal impact socket
D Kraftschrauber-Einsatz
PL Nasadka udarowa sześciokątna
RUS Головка ударная 6-гранная
CZ Šestihranný nástavec
H Hatszögű rátét
RO Cheie tubulară hexagonală de impact
F Douille à choc
I Chiave a bussola esagonale per percussione
E Boquilla de percusión
CN 六角风动套筒

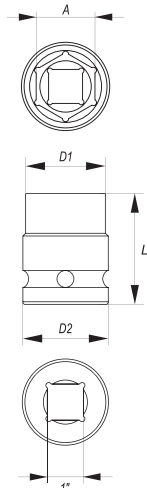

COLOR BOX



1"
25 mm

CrMo
SCM-440

AS-DRIVE

YATO	∅ A (mm)	D1 (mm)	D2 (mm)	L (mm)	PCS packing	
YT-1180	24	42	54	59	6	24
YT-1183	27	46	54	59	6	24
YT-1184	28	47	54	59	6	24
YT-1185	29	48	54	60	6	24
YT-1186	30	49	54	60	6	24
YT-1187	32	52	54	61	6	24
YT-1188	33	53	54	61	6	24
YT-1189	34	54	54	61	6	24
YT-1191	36	57	54	65	6	24
YT-1193	38	60	54	65	5	20
YT-1194	41	63	54	65	4	16
YT-1196	46	69	54	73	3	12
YT-1197	48	72	54	73	2	8
YT-1198	50	75	54	73	2	8

- GB Hexagonal deep impact socket
D Kraftschrauber-Einsatz, lang
PL Nasadka udarowa sześciokątna długa
RUS Головка ударная 6-гранная глубокая
CZ Šestihranný hluboký nástavec
H Hatszögű rátét mély
RO Cheie tubulară hexagonală de impact adâncă
F Douille profonde à choc
I Chiave a bussola esagonale per percussione
E Boquilla de percusión profunda
CN 六角风动长套筒

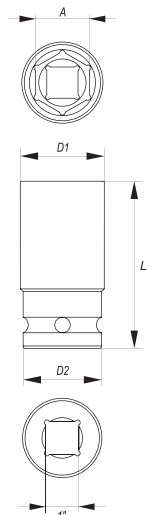

COLOR BOX



1"
25 mm

CrMo
SCM-440

AS-DRIVE

YATO	∅ A (mm)	D1 (mm)	D2 (mm)	L (mm)	PCS packing	
YT-1175	27	46	54	90	6	24
YT-1176	30	50	54	90	6	24
YT-1177	32	52	54	90	6	24
YT-1178	33	54	54	90	6	24
YT-1179	36	57	54	90	6	24

- GB Impact extension bar with adapter
D Verlängerung mit Adapter
PL Przedłużka udarowa z redukcją
RUS Удлинитель с редукцией
CZ Proloužení s redukcí
H Hosszabbító szár adapterrel
RO Bara extensie cu adaptor
F Rallonge avec reduction
I Prolunga per percussione con riduttore
E Tubo de prolongación con reductor
CN 风动转换接头

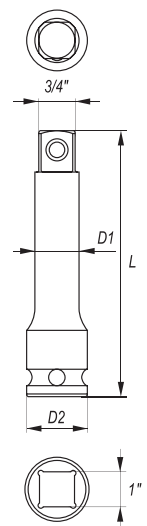

COLOR BOX



1"
25 mm

CrMo
SCM-440

YATO	∅ A	∅ B	D1 (mm)	D2 (mm)	L (mm)	PCS packing	
YT-1169	1" (25.4 mm) (F)	3/4" (19.0mm) (M)	53	33	250	6	12

GB Hexagonal impact socket
 D Kraftschrauber-Einsatz
 PL Nasadka uderowa sześciokątna
 RUS Головка ударная 6-гранная
 CZ Šestihřanný nástavec
 H Hatszögű rátét
 RO Cheie tubulară hexagonală de impact
 F Douille à choc
 I Chiave a bussola esagonale per percussione
 E Boquilla de percusión
 CN 六角风动套筒

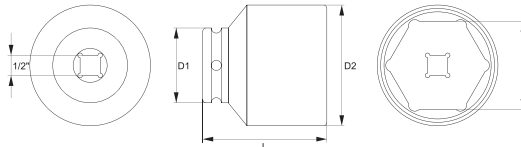

COLOR BOX



1/2"
12.5mm

FOR FRONT HUB NUTS DO PIAST

CrMo
SCM-440

AS-DRIVE

YATO	Ø A (mm)	D1 (mm)	D2 (mm)	L (mm)	PCS packing:	
YT-1029	52	44	71	72	3	12

GB Bi-hexagonal impact socket
 D Zwölfkant-Kraftschrauber-Einsatz
 PL Nasadka uderowa dwunastokątna
 RUS Головка ударная 12-гранная
 CZ Vanáctihřanný nástavec
 H Dugófej, 12 lapú
 RO Cheie tubulară bihexagonală de impact
 F Douille à choc
 I Chiave a bussola esagonale per percussione
 E Boquilla bihexagonal de percusión
 CN 风动套筒

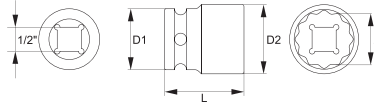

COLOR BOX



1/2"
12.5mm

FOR FRONT HUB NUTS DO PIAST

CrMo
SCM-440

AS-DRIVE

YATO	Ø A (mm)	D1 (mm)	D2 (mm)	L (mm)	PCS packing:	
YT-1027	24	30	34	39	10	120

GB Bi-hexagonal deep impact socket
 D Zwölfkant-Kraftschrauber-Einsatz, lang
 PL Nasadka uderowa dwunastokątna długa
 RUS Головка ударная 12-гранная глубокая
 CZ Vanáctihřanný hluboký nástavec
 H Dugófej, mély, 12 lapú
 RO Cheie tubulară bihexagonală de impact adâncă
 F Douille à choc
 I Chiave a bussola esagonale per percussione
 E Boquilla bihexagonal de percusión profunda
 CN 风动套筒

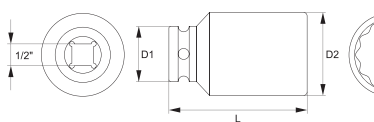

COLOR BOX



1/2"
12.5mm

FOR FRONT HUB NUTS DO PIAST

CrMo
SCM-440

AS-DRIVE

YATO	Ø A (mm)	D1 (mm)	D2 (mm)	L (mm)	PCS packing:	
YT-1028	33	30	45	75	8	32

GB Impact bit socket set
 D Schlagsteckschlüsselsatz
 PL Zestaw uderowych kluczy trzpieniowych
 RUS Набор ударных торцевых ключей
 CZ Souprava rázových zástrčných klíčů
 H Üthető dugókulcs bit - készlet
 RO Set chei de șoc cu bolt
 F Set de douilles à choc
 I Set di chiavi a bussola per percussione
 E Juego de llaves de mandril de impacto
 CN 风动套筒批头组套

BMC & COLOR SLEEVE



8
PCS

1/2"
12.5mm

CrMo

HRC
54



T30, T40, T45, T50, T55, T60, TORX T70, T80

6, 7, 8, 10, 12, 14, 17, 19 mm
HEX

YATO	Ø	
YT-1065	1/2" (12.7 mm)	15

YATO	Ø	
YT-1066	1/2" (12.7 mm)	15



RMS, RM6, RM7, RM8, RM10, RM11, RM12, RM13
RIBE

M5, M6, M8, M10, M12, M14, M16, M18
SPLINE

YATO	Ø	
YT-1068	1/2" (12.7 mm)	15

YATO	Ø	
YT-1069	1/2" (12.7 mm)	15

GB Spline impact bit set
 D Schlagwerkzeugsatz - Spline
 PL Zestaw bitów uderowych - Spline
 RUS Набор ударных битов - Spline
 CZ Souprava bitů pro rázové utahováky - Spline
 H Ütő bit készlet - Spline
 RO Set tubulare de impact
 F Set d'embouts à choc
 I Set di chiavi a bussola per percussione Spline
 E Juego de las piezas de percusión - Spline
 CN 风动花键批头组套

BMC & COLOR BOX



6
PCS

3/4"
19mm

SPLINE (XZN)

CrMo

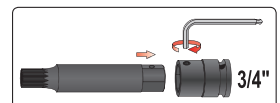

M12, M14, M16, M18 x 22 mm; (L=107 mm); CrMo;
 3/4" (19.0 mm) x 22 mm; CrMo;

YATO	Ø	
YT-1157	3/4" (19.0 mm)	8

Memo

4

Torque wrenches & torque multipliers Klucze dynamometryczne i wzmacniacze momentu



Torque wrenches

Klucze dynamometryczne

90



Torque angle gauges

Kątomierze do dokręcania śrub

91



Torque wrenches with metal handle

Klucze dynamometryczne z metalową rączką

90

Torque wrenches with plastic handle

Klucze dynamometryczne z plastikową rączką

90

Torque multipliers

Wzmacniacze momentu

91



GB Torque wrench
D Drehmomentschlüssel
PL Klucz dynamometryczny
RUS Ключ динамометрический

CZ Dynamometrický klíč
H Nyomatékkulcs
RO Cheie cu dinamometru
F Clé dynamométrique

I Chiave dinamometrica
E Llave dinamométrica
CN 传统型可调式扭力扳手

1/2"	3/8"	CrV 6140
12.5mm	10mm	



YATO	Ø	Nm	L (mm)	Box
YT-0750	3/8" (9.5 mm)	20-110	366	20
YT-0760	1/2" (12.7 mm)	42-210	470	12

GB Torque wrench
D Drehmomentschlüssel
PL Klucz dynamometryczny
RUS Ключ динамометрический

CZ Dynamometrický klíč
H Nyomatékkulcs
RO Cheie cu dinamometru
F Clé dynamométrique

I Chiave dinamometrica
E Llave dinamométrica
CN 传统型可调式扭力扳手

3/4"	1/2"	CrV 6140
19mm	12.5mm	



YT-0771

- application: automotive service stations, trucks
- wrench and extension pipe designed to tighten screws in double wheels
- measurement tolerance +/- 3%

YT-0771

- przeznaczenie: serwis, samochody ciężarowe
- łącznie z przedłużką dostosowany do dokręcania śrub w kołach bliźniaczych
- dokładność pomiarowa +/- 3%

YATO	Ø	Nm	L (mm)	Box
YT-0761	1/2" (12.7 mm)	40-210	535	10
YT-0770	3/4" (19.0 mm)	100-500	865	4
YT-0771	3/4" (19.0 mm)	140-980	1230	2

GB Torque wrench
D Drehmomentschlüssel
PL Klucz dynamometryczny
RUS Ключ динамометрический

CZ Dynamometrický klíč
H Nyomatékkulcs
RO Cheie cu dinamometru
F Clé dynamométrique

I Chiave dinamometrica
E Llave dinamométrica
CN 传统型可调式扭力扳手

1/4"	CrV 6140
6.3mm	



YATO	Ø	Nm	L (mm)	Box
YT-0751	1/4" (6.3 mm)	2-10	281	24

GB Torque wrench
D Drehmomentschlüssel
PL Klucz dynamometryczny
RUS Ключ динамометрический

CZ Dynamometrický klíč
H Nyomatékkulcs
RO Cheie cu dinamometru
F Clé dynamométrique

I Chiave dinamometrica
E Llave dinamométrica
CN 传统型可调式扭力扳手

3/4"	1/2"	CrV 6140
19mm	12.5mm	



YATO	Ø	Nm	L (mm)	Box
YT-0754	1/2" (12.7 mm)	60-340	613	10
YT-0755	3/4" (19.0 mm)	200-1000	1234	2

GB Torque wrench
D Drehmomentschlüssel
PL Klucz dynamometryczny
RUS Ключ динамометрический

CZ Dynamometrický klíč
H Nyomatékkulcs
RO Cheie cu dinamometru
F Clé dynamométrique

I Chiave dinamometrica
E Llave dinamométrica
CN 传统型可调式扭力扳手

3/4"	TOLERANCE TOLERANȚA CW ++3% CCW +-5%	HRC 48-52	CrV 6140
19mm			



BMC & COLOR SLEEVE

YATO	Ø	Nm	L (mm)	Box
YT-0771	3/4" (19.0 mm)	150-800	1170	2

- GB Torque angle gauge
D Winkelmesser zum Anziehen von Schrauben
PL Kałomierz do dokręcania śrub
RUS Угломер для подвёртывания болтов
CZ Úhlohměr k utahování šroubů
H Nyomaték szögmérő
RO Raportor pt. înşurubat şuruburi
F Rapporteur à serrer les vis
I Goniometro per il serraggio controllo
E Calibrador para apretar tornillos
CN 扭力角度规



1/2"
12.5mm 360° CrV

SLIDING CARD



YATO	
YT-0593	12/48

4

- GB Torque multiplier
D Drehmomentverstärker
PL Mechaniczny wzmacniacz momentu
RUS Мультипликатор крутящего момента
- CZ Mechanický posilovač momentu
H Nyomaték sokszorozó
RO Antrenor cu amplificator de forta
F Amplificateur de couple mécanique
- I Moltiplicatore di coppia
E Mecanismo de reforzar el momento
CN 3倍扭力倍增器

3/4" max. 900 Nm 1" max. 2700 Nm 3:1 CrMo 4140

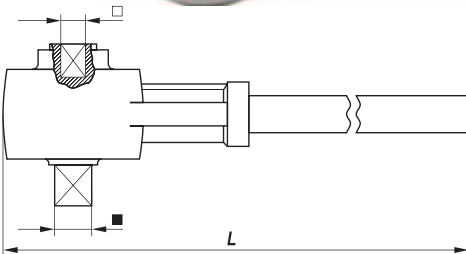

BMC & COLOR SLEEVE



YATO	F	Tmax. (Nm)	M	Tmax. (Nm)	L (mm)	
YT-0781	3/4" (19.0 mm)	900	1" (25.4 mm)	2700	500	2

- GB Labor save wrench
D Drehmomentverstärker
PL Mechaniczny wzmacniacz momentu
RUS Механический усилитель силы
CZ Mechanický posilovač momentu
H Nyomaték sokszorozó
RO Antrenor cu amplificator de forta
F Amplificateur de couple mécanique
I Moltiplicatore di coppia
E Mecanismo de reforzar el momento
CN 扭力倍增器

1" 25mm 32,33mm 4200 Nm (max) I-1:3.8 II-1:58 CrV

- GB Labor save wrench
D Drehmomentverstärker
PL Mechaniczny wzmacniacz momentu
RUS Механический усилитель силы
CZ Mechanický posilovač momentu
H Nyomaték sokszorozó
RO Antrenor cu amplificator de forta
F Amplificateur de couple mécanique
I Moltiplicatore di coppia
E Mecanismo de reforzar el momento
CN 扭力倍增器

1" 25mm 32,33mm 5800 Nm (max) 1:66 CrV



BMC & COLOR SLEEVE



YATO	Ø	Nm	L (mm)	
YT-0782	1" (25.4 mm)	4200	330	1



BMC & COLOR SLEEVE



YATO	Ø	Nm	L (mm)	
YT-07822	1" (25.4 mm)	5800	380	1

5

Screwdrivers & screwdriver bits Wkrętaki i końcówki wkrętakowe



Screwdrivers, 3 color handle
Wkrętaki, trójkolorowa rączka

94-97



Special screwdrivers & impact screwdrivers
Wkrętaki specjalne i udarowe

102-103



Slotted screwdrivers

Wkrętaki płaskie.....

94

Ratchet screwdriver sets

Wkrętaki z grzechotką.....

102

Phillips screwdrivers

Wkrętaki krzyżakowe.....

94

Impact screwdrivers

Wkrętaki udarowe.....

103

Pozidrive screwdrivers

Wkrętaki „Pozidrive”.....

94

Screwdriver bits

Końcówki wkrętakowe

103-107



Torx screwdrivers

Wkrętaki „Torx”.....

94

Torx Security screwdrivers

Wkrętaki „Torx Security”.....

94

Go-through screwdrivers

Wkrętaki do pobijania.....

95

Phillips screwdriver bits

Końcówki wkrętakowe krzyżakowe.....

103

Screwdriver sets

Komplety wkrętaków.....

95

Torx screwdriver bits

Końcówki wkrętakowe „Torx”.....

103

YATO NON-SLIP SYSTEM screwdriver bits

Końcówki wkrętakowe „YATO NON-SLIP SYSTEM”.....

103

Screwdriver bit sets

Zestawy końcówek wkrętakowych.....

103

Screwdrivers, 3 color handle
Wkrętaki, trójkolorowa rączka

98-99



Nut setters

Nasadki magnetyczne do wkrętarek

108



Slotted screwdrivers

Wkrętaki płaskie.....

98

Screwdriver bit holders

Uchwyty do końcówek wkrętakowych

108



Phillips screwdrivers

Wkrętaki krzyżakowe.....

98

Pozidrive screwdrivers

Wkrętaki „Pozidrive”.....

98

Torx screwdrivers

Wkrętaki „Torx”.....

98

Torx Security screwdrivers

Wkrętaki „Torx Security”.....

98

Screwdriver sets

Komplety wkrętaków.....

99

Hex & Torx keys & sets

Klucze imbusowe i zestawy

108-113



Precision screwdrivers, 3 color handle
Wkrętaki precyzyjne, trójkolorowa rączka

99



Insulated hex keys

Klucze imbusowe izolowane.....

108

Hex keys with handle

Klucze imbusowe z rękojeścią.....

109

T-handle keys & sets

Klucze imbusowe typu „T” i zestawy.....

109

Hex key sets

Zestawy kluczy imbusowych.....

111

Torx Tamperproof keys

Klucze imbusowe „Torx Tamperproof”.....

113

Plastic covered Hex keys

Klucze imbusowe powlekane.....

113

Precision slotted screwdrivers

Wkrętaki precyzyjne płaskie.....

99

Precision phillips screwdrivers

Wkrętaki precyzyjne krzyżakowe.....

99

Precision Torx screwdrivers

Wkrętaki precyzyjne „Torx”.....

99

Precision screwdriver sets

Zestawy wkrętaków precyzyjnych.....

99

Insulated screwdrivers

Wkrętaki izolowane

100-101



Insulated slotted screwdrivers

Wkrętaki izolowane płaskie.....

100

Insulated phillips screwdrivers

Wkrętaki izolowane krzyżakowe.....

100

Insulated Pozidrive screwdrivers

Wkrętaki izolowane „Pozidrive”.....

100

Insulated screwdriver sets

Komplety wkrętaków izolowanych.....

100

GB Screwdriver
 D Schraubendreher
 PL Wkrętarz
 RUS Отвёртка
 CZ Šroubovák
 H Csavarhúzó

RO Şurubelniţă
 F Tournevis
 I Cacciavite
 E Destornillador
 CN 螺丝刀

PLASTIC HANGER



COLOR BOX



PCS packing:



S2

HRC 58



YATO	⊖	L (mm)	PCS packing:	
YT-25900	2	75	12	96/384
YT-25901	3	75	12	96/384
YT-25902	3	100	12	96/384
YT-25903	3	150	12	60/240
YT-25904	4	100	12	96/384
YT-25905	4	150	12	96/384
YT-25906	4	200	12	96/384
YT-25907	5	75	12	60/240

YATO	⊖	L (mm)	PCS packing:	
YT-25908	5	100	12	60/240
YT-25909	5	150	12	60/240
YT-25910	6	38	12	60/240
YT-25911	6	100	12	36/144
YT-25912	6	150	12	36/144
YT-25913	6	200	12	36/144
YT-25914	8	150	6	24/96



YATO	⊕	L (mm)	PCS packing:	
YT-25920	PH0	75	12	96/384
YT-25921	PH0	100	12	96/384
YT-25922	PH1	38	12	60/240
YT-25923	PH1	75	12	60/240
YT-25924	PH1	100	12	60/240
YT-25925	PH1	150	12	60/240
YT-25926	PH1	200	12	36/144
YT-25927	PH1	300	6	24/96

YATO	⊕	L (mm)	PCS packing:	
YT-25928	PH2	38	12	60/240
YT-25929	PH2	100	12	36/144
YT-25930	PH2	150	12	36/144
YT-25931	PH2	200	12	36/144
YT-25932	PH2	300	6	24/96
YT-25933	PH3	150	6	24/96
YT-25934	PH3	200	6	24/96



YATO	⊕	L (mm)	PCS packing:	
YT-25940	PZ1	75	12	60/240
YT-25941	PZ1	100	12	60/240

YATO	⊕	L (mm)	PCS packing:	
YT-25942	PZ2	100	12	36/144
YT-25943	PZ2	150	12	36/144



YATO	⊗	L (mm)	PCS packing:	
YT-25950	T5	75	12	96/384

YATO	⊗	L (mm)	PCS packing:	
YT-25951	T6	75	12	96/384



YATO	⊗	L (mm)	PCS packing:	
YT-25952	T7	75	12	96/384
YT-25953	T8	75	12	96/384
YT-25954	T9	75	12	96/384
YT-25955	T10	100	12	60/240
YT-25956	T15	100	12	60/240

YATO	⊗	L (mm)	PCS packing:	
YT-25957	T20	100	12	60/240
YT-25958	T25	100	12	36/144
YT-25959	T27	100	12	36/144
YT-25960	T30	100	12	36/144
YT-25961	T40	100	6	24/96

GB Go-through screwdriver
D Schlagschrauber
PL Wkrętko do pobijania
RUS Отвёртка-било
CZ Šroubovák s úderným koncem
H Beütő csavarhúzó

RO Șurubelniță pt. fixare
F Tournevis à frapper
I Cacciaviti per viti con intaglio
E Destornillador para dar golpes
CN 敲击螺丝批

PLASTIC HANGER



6 PCS

COLOR BOX



CrV
6150

HRC
52



YATO	⊖	L (mm)	PCS packing	
YT-25985	6	100	6	24/96
YT-25986	6	150	6	24/96
YT-25987	6	200	6	24/96
YT-25988	6	250	6	24/96
YT-25989	8	150	6	24/72
YT-25990	8	200	6	24/72
YT-25991	8	250	6	24/72
YT-25992	8	300	6	24/72

YATO	⊕	L (mm)	PCS packing	
YT-25993	PH2	100	6	24/96
YT-25994	PH2	150	6	24/96
YT-25995	PH3	150	6	24/72
YT-25996	PH3	200	6	24/72
YT-25997	PH3	250	6	24/72

GB Screwdriver set
D Schraubendrehersatz
PL Komplet wkrętków
RUS Набор отвёрток
CZ Zámečnické šroubováky
H Lakatos csavarhózó
RO Șurubelnițe de lăcătușerie
F Set de tournevis
I Set cacciaviti
E Juego de destornilladores
CN 螺丝批组套

2
PCS



CrV
6150

HRC
52



DOUBLE BLISTER



YATO	⊖	⊕	L (mm)	
YT-25998	6		150	6/36
		PH2	150	

GB Screwdriver set
D Schraubendrehersatz
PL Komplet wkrętków
RUS Набор отвёрток
CZ Zámečnické šroubováky
H Lakatos csavarhózó

RO Șurubelnițe de lăcătușerie
F Set de tournevis
I Set cacciaviti
E Juego de destornilladores
CN 螺丝批组套

DOUBLE BLISTER



S2

HRC
58



6
PCS



YATO	⊖	⊕	L (mm)	
YT-25965	3.0		75	6/24
	5.0		100	
	6.0		100	
		PH0	75	
		PH1	100	
		PH2	100	



8
PCS



YATO	⊖	⊕	L (mm)	
YT-25980	2.0		50	6/24
	2.4		50	
	6.0		38	
	6.0		100	
		PH0	50	
		PH1	50	
		PH2	38	
		PH2	100	

GB Screwdriver set
 D Schraubendrehersatz
 PL Komplet wkrętek
 RUS Набор отвёрток
 CZ Zámečnické šroubováky
 H Lakatos csavarhózó

RO Şurubelnițe de lăcătușerie
 F Set de tournevis
 I Set cacciaviti
 E Juego de destornilladores
 CN 螺丝批组套

DOUBLE
BLISTER



8
PCS



YATO	⊖	⊕	L (mm)	
YT-25966	5.0		100	6/12
	6.0		100	
	8.0		150	
		PH0	75	
		PH1	100	
		PH2	38	
		PH2	100	
		PH3	150	



12
PCS



YATO	⊖	⊕	⊗	L (mm)	
YT-25967	3.0			75	6/12
	5.0			75	
	6.0			38	
	6.0			150	
	8.0			150	
		PH0		75	
		PH1		75	
		PH2		38	
		PH2		100	
		PH3		150	
			SQ1	100	
			SQ2	100	



15
PCS



YATO	⊖	⊕	⊗	L (mm)	
YT-25981	1.5			50	6/24
	2.0			50	
	5.0			75	
	6.0			38	
	6.0			100	
	6.0			125	
		PH00		50	
		PH0		50	
		PH1		75	
		PH2		38	
		PH2		100	
			T5	50	
			T6	50	
			T7	50	
			T8	50	

GB 6 in 1 interchangeable screwdriver set
 D Umsteckschraubendreher
 PL Wkrętek z końcówkami dwustronnymi
 RUS Отвёртка с двухсторонними насадками
 H Csavarhúzó kétvégű szárral
 RO Şurubelniță cu dublu capăt
 F Tournevis embouts réversibles
 I Cacciavite reversibile
 E Destornillador con punta de dos caras
 CN 6合1螺丝批组套



DOUBLE
BLISTER



YATO	
YT-25971	12/96

GB Mini pick & hook set
 D Mini hacken set
 PL Zestaw haczyków z rękojeścią
 RUS Набор ключков с рукоятками
 CZ Sada háčkových mini páčidel
 H Mini ár és kampó készlet

RO Mini-set pt. extras garnituri
 F Set de crochets
 I Set ganci con maniglia
 E Juego de palancas de hierro
 CN 迷你拉拔器组套

4
PCS



HRC
40



SLIDING
CARD



YATO	
YT-0843	12/72

GB Screwdriver set
D Schraubendrehersatz
PL Komplet wkrętaków
RUS Набор отвёрток

CZ Zámečnické šroubováky
H Lakatos csavarhózo
RO Şurubelnițe de lăcătușerie
F Set de tournevis

I Set cacciaviti
E Juego de destornilladores
CN 螺丝批组套



S2

HRC
58



9
PCS



PLASTIC
HANGER



YATO	⊖	⊕	L (mm)	
YT-25968	3.0		75	6/12
	5.0		75	
	6.0		100	
	6.0		150	
	8.0		150	
		PH0	75	
		PH1	75	
		PH2	100	
		PH2	150	



18
PCS



PLASTIC HANGER
& DOUBLE BLISTER



YATO	⊖	⊕	★	L (mm)	
YT-25982	2.4			50	6/12
	3.0			50	
	5.0			75	
	6.0			38	
	6.0			100	
	8.0			150	
		PH00		50	
		PH0		50	
		PH1		75	
		PH2		38	
		PH2		100	
		PH3		150	
			T5	50	
			T6	50	
			T7	50	
			T8	50	
			T9	50	
		T10	50		

GB Screwdriver CZ Šroubovák I Cacciavite
 D Schraubendreher H Csavarhúzó E Destornillador
 PL Wkrętarz RO Șurubelniță CN 螺丝刀
 RUS Отвёртка F Tournevis

COLOR BOX

SVC55





- application: industry
- can be used as go-through
- special highest quality alloy steel
- przeznaczenie: przemysł
- możliwość pobijania
- stal wysokostopowa



 **HRC 58-62**

 **HRC 55-59**

YATO	⊖	L (mm)	PCS packing	
YT-2601	3.0	75	12	240
YT-2606	4.0	100	12	240
YT-2608	5.5	100	12	240
YT-2609	5.5	150	12	240
YT-2610	5.5	200	12	240
YT-2612	6.5	38	12	240
YT-2613	6.5	100	12	240
YT-2614	6.5	150	12	240
YT-2615	6.5	200	12	240

YATO	⊖	L (mm)	PCS packing	
YT-2618	8.0	150	6	120
YT-2602	3.0	100	12	240
YT-2633	3.0	300	12	240
YT-2604	4.0	75	12	240
YT-2634	4.0	400	12	240
YT-2635	5.0	300	12	120
YT-2636	5.0	400	12	120

- application: industry
- can be used as go-through
- special highest quality alloy steel
- przeznaczenie: przemysł
- możliwość pobijania
- stal wysokostopowa



 **HRC 58-62**

 **HRC 55-59**

YATO	⊕	L (mm)	PCS packing	
YT-2640	PH0	75	12	240
YT-2642	PH1	75	12	240
YT-2643	PH1	100	12	240
YT-2644	PH1	150	12	240
YT-2645	PH1	200	12	240
YT-2647	PH2	38	12	240
YT-2648	PH2	100	12	240
YT-2649	PH2	150	12	240
YT-2650	PH2	200	12	240
YT-2653	PH3	150	6	120

YATO	⊕	L (mm)	PCS packing	
YT-2637	PH0	300	12	240
YT-2641	PH1	38	12	240
YT-2638	PH1	400	12	120
YT-2639	PH2	400	12	120

- application: industry
- can be used as go-through
- special highest quality alloy steel
- przeznaczenie: przemysł
- możliwość pobijania
- stal wysokostopowa



 **HRC 58-62**

 **HRC 55-59**

YATO	⊕	L (mm)	PCS packing	
YT-2661	PZ0	75	12	240
YT-2663	PZ1	100	12	240
YT-2665	PZ2	150	12	240
YT-2667	PZ3	150	6	240

YATO	⊕	L (mm)	PCS packing	
YT-2657	PZ1	400	12	120
YT-2655	PZ2	38	12	240
YT-2658	PZ2	400	12	120

- application: industry
- can be used as go-through
- special highest quality alloy steel
- przeznaczenie: przemysł
- możliwość pobijania
- stal wysokostopowa



 **HRC 58-62**

 **HRC 58-62**

YATO	⊗	L (mm)	PCS packing	
YT-2741	T5	75	12	240
YT-2742	T6	75	12	240

YATO	⊗	L (mm)	PCS packing	
YT-2743	T7	75	12	240
YT-2744	T8	75	12	240
YT-2745	T9	75	12	240
YT-2746	T10	100	12	240
YT-2748	T15	100	12	240
YT-2750	T20	100	12	240
YT-2752	T25	100	12	240
YT-2753	T27	100	12	240
YT-2754	T30	100	12	240
YT-2756	T40	100	12	240

GB Screwdriver set
D Schraubendrehersatz
PL Komplet wkrętaków
RUS Набор отвёрток
CZ Zámečnické šroubováky
H Lakatos csavarhúzó

RO Şurubelnițe de lăcătușerie
F Set de tournevis
I Set cacciaviti
E Juego de destornilladores
CN 螺丝批组套

DOUBLE
BLISTER



SVC55

HRC 58-62

6
PCS



8
PCS



YATO	⊖	⊕	L (mm)	
YT-2668	5.5		100	6/24
	6.5		100	
	8.0		150	
		PH1	100	
		PH2	100	
		PH3	150	

YATO	⊖	⊕	L (mm)	
YT-2670	4.0		100	4/16
	5.5		100	
	6.5		38	
	6.5		100	
		PH0	75	
		PH1	100	
		PH2	38	
		PH2	100	

GB Precision screwdriver
D Präzisions-Schraubendreher
PL Wkrętak precyzyjny
RUS Отвёртка для точных работ

CZ Šroubovák pro jemnou mechaniku
H Műszerész csavarhúzó
RO Şurubelniță mecanica fina
F Tournevis de précision

I Cacciavite di precisione
E Destornillador de precisión
CN 螺丝批

S2

HRC 57-61



YATO	⊖	L (mm)	
YT-25802	1.4	50	50/400
YT-25803	1.6	50	50/400
YT-25804	1.8	50	50/400
YT-25805	2.0	50	50/400
YT-25806	2.0	75	50/400
YT-25807	2.4	50	50/400
YT-25808	2.4	75	50/400
YT-25809	3.0	50	50/400
YT-25810	3.0	75	50/400
YT-25811	3.0	100	50/400

YATO	⊕	L (mm)	
YT-25831	PH000	50	50/400
YT-25832	PH000	75	50/400
YT-25833	PH000	50	50/400
YT-25834	PH000	75	50/400
YT-25835	PH0	50	50/400
YT-25836	PH0	75	50/400
YT-25837	PH0	100	50/400
YT-25838	PH1	50	50/400
YT-25839	PH1	100	50/400
YT-25840	PH1	150	50/400

YATO	⊗	L (mm)	
YT-25852	T5	50	50/400
YT-25853	T6	50	50/400
YT-25854	T7	50	50/400
YT-25855	T8	50	50/400
YT-25856	T9	50	50/400
YT-25857	T10	50	50/400

GB Precision screwdriver set
D Präzisions-Feinmechanikersatz
PL Zestaw wkrętaków precyzyjnych
RUS Набор прецизионных отвёрток

CZ Šroubováky sada pro jemnou mechaniku
H Órás csavarhúzó készlet
RO Set surubelnițe

F Set de tournevis de précision
I Set cacciavite di precisione
E Destornilladores precisos
CN 螺丝批组套

PLASTIC BOX & DOUBLE BLISTER



S2

HRC 57-61

6
PCS



6
PCS



7
PCS



YATO	⊖	⊕	L (mm)	
YT-25861	1.4		50	6/36
	2.0		50	
	2.4		50	
		PH00	50	
		PH0	50	
		PH1	50	

YATO	⊗	L (mm)	
YT-25862	T5	50	6/36
	T6	50	
	T7	50	
	T8	50	
	T9	50	
	T10	50	

YATO	⊖	⊕	⊗	L (mm)	
YT-25863	2.0			50	6/36
	3.0			50	
		PH00		50	
		PH0		50	
			T5	50	
			T6	50	
			T7	50	

GB Insulated screwdriver
D Isolierte Schraubendreher
PL Wkrętak izolowany
RUS Изолированная отвёртка

CZ Izolovaný šroubovák
H Szigetelt csavarhúzó
RO Şurubelniţă izolată
F Tournevis isolé

I Cacciavite isolato
E Destornillador aislado
CN 绝缘螺丝批

PLASTIC HANGER



1000 V

S2

HRC 56-60



⊖ • application: industry • przeznaczenie: przemysł
• VDE certificate • certyfikat VDE

YATO	⊖	L (mm)	
YT-2815	3.0	75	12/120
YT-2816	4.0	75	12/120
YT-2817	4.0	100	12/120

YATO	⊖	L (mm)	
YT-2818	5.5	125	12/120
YT-2819	6.5	150	12/120
YT-2820	8.0	175	12/120



⊕ • application: industry • przeznaczenie: przemysł
• VDE certificate • certyfikat VDE

YATO	⊕	L (mm)	
YT-2821	PH0	60	12/120
YT-2822	PH1	80	12/120

YATO	⊕	L (mm)	
YT-2823	PH2	100	12/120
YT-2824	PH3	150	12/120



⊕ • application: industry • przeznaczenie: przemysł
• VDE certificate • certyfikat VDE

YATO	⊕	L (mm)	
YT-2825	PZ1	80	12/120

YATO	⊕	L (mm)	
YT-2826	PZ2	100	12/120

GB Insulated screwdriver set
D Isolierte Schraubendrehersatz
PL Komplet wkrętaków izolowanych
RUS Изолированная отвёртка - набор

CZ Izolované šroubováky
H Szigetelt csavarhúzó
RO Şurubelniţă izolată
F Set de tournevis isolés

I Set di cacciavite isolato
E Juego de destornilladores aislado
CN 绝缘螺丝批组套

DOUBLE BLISTER



1000 V

S2

HRC 56-60



5 PCS ⊖ ⊕ • application: industry • przeznaczenie: przemysł
• VDE certificate • certyfikat VDE

YATO	⊖	⊕	L (mm)	
YT-2827	3.0		75	20/40
	4.0		100	
	5.5		125	
		PH1	80	
		PH2	100	

7 PCS ⊖ ⊕ ⊕ • application: industry • przeznaczenie: przemysł
• VDE certificate • certyfikat VDE

YATO	⊖	⊕	⊕	L (mm)	
YT-2828	3.0			75	20/40
	4.0			100	
	5.5			125	
		PH1		80	
		PH2		100	
			PZ1	80	
			PZ2	100	

Screwdrivers & screwdriver bits Wkrętaki i końcówki wkrętakowe



GB Insulated changeable screwdriver set
D Schraubendreher Satz isoliert
PL Zestaw wkrętak z wymiennymi końcówkami izolowanymi

RUS Набор изолированных отверток
CZ Sada izolovaného nářadí
H Csavarhúzó kétvégű szárral
RO Set surubelnita cu biti, izolate

F Jeu d'outils isolés
I Set di cacciavite isolato
E Juego de destornilladores aislado
CN 绝缘螺丝批组套

NYLON CASE



1000 V

HRC 54-61

S2



1000V
VDE CERTIFICATE
EN 60900:2012

12 PCS



4x190 mm; 250V

YATO		⊖	⊕	L (mm)	
YT-28290		2.0		100	4/48
		2.5		100	
		3.0		100	
		3.5		100	
		4.0		100	
		5.5		100	
		6.5		100	
			PH0	100	
			PH1	100	
			PH2	100	



1000V
VDE CERTIFICATE
EN 60900:2012

50 PCS



4x190 mm; 250V

YATO		⊖	⊕	⊕	⊗	⊙	⊙	⊙	⊙	⊙	L (mm)		
YT-28293		2.0									100	2/16	
		2.5									100		
		3.0									100		
		3.5									100		
		4.0									100		
		5.5									100		
		6.5									100		
			PH0										100
			PH1										100
			PH2										100
				PZ0									100
				PZ1									100
				PZ2									100
					T6								100
					T8								100
					T9								100
					T10								100
					T15								100
					T20								100
					T25								100
					T27								100
					T30								100
						2.0							100
						3.0							100
						4.0							100
						5.0							100
						6.0							100
							R1						100
							R2						100
								1.0					100
								2.0					100
								3.0					100
								4.0					100
								4.0			100		
								6.0			100		
								8.0			100		
								10.0			100		
									4.0		100		
									6.0		100		
									8.0		100		
									10.0		100		
										M4	100		
										M5	100		
										M6	100		

GB 22 in 1 interchangeable screwdriver set
D Umsteckschraubendreher
PL Wkrętarz z końcówkami dwustronnymi
RUS Отвёртка - двухсторонние насадки
CZ Šroubovák lancer z dvoustrannou koncovkou
H Csavarhúzó kétvégű szárral

RO Șurubelniță cu dublu capăt
F Tournevis + embouts 22 en 1
I Set cacciavite con punte reversibile
E Destornillador con punta dos caras
CN 22合一螺丝批组套

DOUBLE
BLISTER



12 PCS
22 in 1



- 4 mm x 5.5 mm (L=175/115 mm);
- 6.5 mm x PH3 (L=175/115 mm);
- PH1 x PH2 (L=175/115 mm);
- PZ1 x PZ2 (L=175/115 mm);
- 3 mm x 3 mm (L=175/115 mm);
- 4 mm x 4 mm (L=175/115 mm);
- 5 mm x 5 mm (L=175/115 mm);
- 6 mm x 6 mm (L=175/115 mm);
- T10 x T15 (L=175/115 mm);
- T20 x T25 (L=175/115 mm);
- T30 x T40 (L=175/115 mm)



YATO	
YT-2797	6/12

GB Ratchet screwdriver set
D Ratschenschraubendreher-set mit einsätzen
PL Wkrętarz z grzechotką, nasadkami i bitami
RUS Набор головок с трещеткой
CZ Ráčnový kloubový šroubovák s příslušenstvím
H Dugókulcs és bit készlet csukló
RO Set surubelnița
F Clé mixte à cliquet + embouts + douilles
I Set cacciavite a cricchetto con prese punta
E Juego con destornillador y carraca
CN 棘轮螺丝批组套



30 PCS	Icons: Torx, Phillips, Slotted, Hex
1/4" 6.3mm	Icons: Torx, Phillips, Slotted, Hex, CrV 6150
S2	

DOUBLE
BLISTER



- 1/4" (6.3 mm): 3.5, 4.0, 5.5, 6.5 mm (L=25 mm);
- 1/4" (6.3 mm): PH0, PH1, PH2, PH3 (L=25 mm);
- 1/4" (6.3 mm): PZ0, PZ1, PZ2, PZ3 (L=25 mm);
- 1/4" (6.3 mm): 4.0, 5.0, 6.0 mm (L=25 mm);
- 1/4" (6.3 mm): 5, 6(x2), 7(x2), 8, 9(x2), 10(x2), 11, 13 mm; CrV 6150;
- 1/4" (6.3 mm) x 1/4" (6.3 mm): (L=30 mm); 1/4" (6.3 mm): (L= 30 mm)

YATO	
YT-2798	6/36

GB Precision screwdriver with bits
D Schraubendreher und bit-satz
PL Wkrętarz elastyczny z wymiennymi bitami
RUS Отвёртка с прецизионными битами
CZ Šroubovák ráčnový se sadou bitů
H Órás csavarhúzó-bit készlet
RO Surubelnița + set biti
F Tournevis élastique
I Cacciavite flessibile con punte intercambiabili
E Juego de pizas terminales para destornillador + mango
CN 可弯曲批头组套

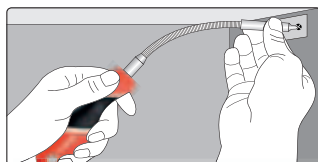

31 PCS	1/4" 6.3mm	Icons: Torx, Phillips, Slotted, Hex
S2		Icons: Torx, Phillips, Slotted, Hex, CrV 6150

DOUBLE
BLISTER



- 215 mm;
- 1/4" (6.3 mm): 3.0, 3.5, 4.0, 5.5, 6.5 mm (L=25 mm);
- 1/4" (6.3 mm): PH0, PH1, PH2, PH3 (L=25 mm);
- 1/4" (6.3 mm): PZ0, PZ1, PZ2, PZ3 (L=25 mm);
- 1/4" (6.3 mm): T10, T15 (L=25 mm);
- 1/4" (6.3 mm): 2.0, 3.0, 4.0, 5.0, 6.0 mm (L=25 mm);
- 1/4" (6.3 mm): 5.0, 6.0, 7.0, 8.0(x2), 9.0, 10.0, 11.0, 12.0, 13.0 mm

YATO	
YT-25972	6/24

GB Ratchet screwdriver set
D Ratschenschraubendreher-Satz mit einsätzen
PL Wkrętarz z grzechotką, przegubem i bitami
RUS Набор головок с трещеткой
CZ Ráčnový kloubový šroubovák s příslušenstvím
H Dugókulcs és bit készlet csukló

RO Set surubelnița
F Clé mixte à cliquet + embouts
I Set do chiavi a cricchetto e inserti
E Juego con destornillador y carraca
CN 棘轮螺丝批组套

- 1/4" (6.3 mm): 5, 6, 7, 8, 9, 10, 11, 12, 13 mm;
- 1/4" (6.3 mm) x 100 mm;
- 1/4" (6.3 mm): CrV 50BV30; H2, H2.5, H3, H4, H5, H6;
- T10, T15, T20, T25, T27, T30, T40; PH1, PH1, PH2, PH2, PH3, PH3;
- 3, 4, 5, 6, 7 mm; PZ1, PZ1, PZ2, PZ2, PZ3, PZ3



42 PCS	1/4" 6.3mm	Icons: Torx, Phillips, Slotted, Hex
BITS x30 AISI S2		Icons: Torx, Phillips, Slotted, Hex, CrV 50BV30

PLASTIC BOX
& COLOR BOX



YATO	
YT-2806	12

GB Impact screwdriver
D Schlagschrauber
PL Wkrętak udarowy
RUS Отвёртка ударная

CZ Narazový šroubovák kovový
H Csavarbehajtó, ütő üzemmóddal
RO Şurubelniţă metalică cu percutor
F Tournevis à choc

I Cacciavite percussione
E Destornillador de percusión
CN 冲击螺丝批组套

BITS x6
CrV 6150



1/2"

12.5mm

5/16"

8.0mm



8
PCS

5/16" (7.9 mm) □ □ □ 1/2" (12.7 mm);
⊕ PH2, PH3 (L=35 mm); PH2 (L=80 mm);
□ □ □ 8, 10 mm (L=35 mm); 8 mm (L=80 mm)



7
PCS

5/16" (7.9 mm) □ □ □ 1/2" (12.7 mm);
⊕ PH2, PH3 (L=35 mm); PH2 (L=80 mm);
□ □ □ 8, 10 mm (L=35 mm); 8 mm (L=80 mm)

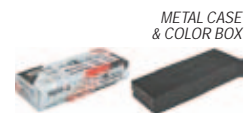

YATO
YT-2800

20

YATO
YT-2801

5/20



7
PCS

5/16" (7.9 mm) □ □ □ 1/2" (12.7 mm);
⊕ PH3 (L=35 mm); PH1, PH2, PH3 (L=75 mm);
□ □ □ 8 mm (L=35 mm); 8 mm (L=75 mm)



YATO
YT-2802

20

GB Screwdriver bit set
D Schraubendreherbitsatz
PL Zestaw bitów do wkrętek udarowych
RUS Набор бит крестовых
CZ Sada bitů

H Bitkészlet
RO Truse bit
F Embouts à choc
I Set punte cacciavite
E Puntas de destornilladora
CN 冲击批头组套

CrV
6150



SLIDING
CARD



for / dla: YT-2800, YT-2801

YATO	⊕	⊖	L (mm)	□ (mm)	PCS packing	📦
YT-2810	PH2		36	5/16" (7.9 mm)	5	10/100
YT-2811	PH3		36	5/16" (7.9 mm)	5	10/100
YT-2812	PH2	8	36	5/16" (7.9 mm)	4	10/100
	PH3	10				

GB Screwdriver bit
D Schraubendreherbit
PL Końcówka śrubokrętowa
RUS Бит крестовая
CZ Šroubováková koncovka
H Csavarhúzóvég

RO Capăt pt. şurubelniţă
F Douille tournevis
I Punta del cacciavite
E Punta de destornilladora
CN 旋具头



SLIDING
CARD



GOLD FORGED KUTE NA ZIMNO

21.8_{max.}

AISI S2

HRC 58-62

GB Screwdriver bit
D Schraubendreherbit
PL Końcówka śrubokrętowa
RUS Бит крестовая
CZ Šroubováková koncovka
H Csavarhúzóvég

RO Capăt pt. şurubelniţă
F Douille tournevis
I Punta del cacciavite
E Punta de destornilladora
CN 旋具头

BLISTER
CARD



AISI S2

YATO	⊕	L (mm)	□ (mm)	📦
YT-0404	T25	30	10	10/100
YT-0405	T25	75	10	10/100
YT-04051	T30	30	10	10/100
YT-04052	T30	75	10	10/100
YT-0406	T40	30	10	10/100
YT-0407	T40	75	10	10/100
YT-0408	T45	30	10	10/100
YT-0409	T45	75	10	10/100

SLIDING
CARD



YATO	⊕	L (mm)	□ (mm)	📦
YT-0485	PH2	100	1/4" (6.3 mm)	25/100
YT-0486	PH2	150	1/4" (6.3 mm)	25/100
YT-0487	PH2	200	1/4" (6.3 mm)	25/100



GB Screwdriver bit
D Schraubendreherbit
PL Końcówka śrubokrętowa
RUS Бит крестовая

CZ Šroubováková koncovka
H Csavarhűzővég
RO Capăt pt. șurubelniță
F Douille tournevis

I Punta del cacciavite
E Punta de destornilladora
CN 旋具头

PLASTIC BOX

AISI S2

HRC 58-61

COLD FORGED KUTE NA ZIMNO



YATO	⊕	L (mm)	⊕	torque / moment obrotowy max. (Nm)	PCS packing	📦
YT-04702	PZ1	25	1/4" (6.3 mm)	6.4	10	25/200
YT-04712	PZ2	25	1/4" (6.3 mm)	19.6	10	25/200
YT-04722	PZ3	25	1/4" (6.3 mm)	45.1	10	25/200

YATO	⊕	L (mm)	⊕	torque / moment obrotowy max. (Nm)	PCS packing	📦
YT-04742	PH1	25	1/4" (6.3 mm)	6.4	10	25/200
YT-04752	PH2	25	1/4" (6.3 mm)	19.6	10	25/200
YT-04762	PH3	25	1/4" (6.3 mm)	45.1	10	25/200



YATO	⊕	L (mm)	⊕	torque / moment obrotowy max. (Nm)	PCS packing	📦
YT-04772	PH1	50	1/4" (6.3 mm)	6.4	10	25/100
YT-04782	PH2	50	1/4" (6.3 mm)	19.6	10	25/100
YT-04792	PH3	50	1/4" (6.3 mm)	45.1	10	25/100

YATO	⊕	⊕	L (mm)	⊕	torque / moment obrotowy max. (Nm)	PCS packing	📦
YT-04812	PH2	PH2	65	1/4" (6.3 mm)	19.6 / 19.6	10	25/100

GB Screwdriver bit set
D Schraubendreherbitsatz
PL Zestaw końcówek śrubokrętowych
RUS Набор битов
CZ Sada bitů

H Bitkészlet
RO Truse bit
F Embouts de vissage șrubokrętowych
I Set punte cacciavite

PLASTIC BOX



10 PCS

AISI S2

HRC 58-61

COLD FORGED KUTE NA ZIMNO

⊕ 5, 6 mm; ⊕ PH1, PH1, PH2, PH2;
⊕ PZ1, PZ1, PZ2, PZ2



⊕ 5, 6 mm; ⊕ PH1, PH1, PH2, PH2;
⊕ PZ1, PZ1, PZ2, PZ2



YATO	L (mm)	⊕	📦
YT-04822	25	1/4" (6.3 mm)	25/200

YATO	L (mm)	⊕	📦
YT-04832	50	1/4" (6.3 mm)	25/100

GB Screwdriver bit
D Schraubendreherbit
PL Końcówka śrubokrętowa
RUS Бит крестовая

CZ Šroubováková koncovka
H Csavarhűzővég
RO Capăt pt. șurubelniță
F Douille tournevis

I Punta del cacciavite
E Punta de destornilladora
CN 旋具头

PLASTIC BOX



AISI S2

HRC 58-61



YATO	⊕	L (mm)	⊕	torque / moment obrotowy max. (Nm)	PCS packing	📦
YT-78130	PH0	25	1/4" (6.3 mm)	2.1	10	20/100
YT-78131	PH1	25	1/4" (6.3 mm)	7.8	10	20/100
YT-78132	PH2	25	1/4" (6.3 mm)	19.6	10	20/100
YT-78133	PH3	25	1/4" (6.3 mm)	45.6	10	20/100

YATO	⊕	L (mm)	⊕	torque / moment obrotowy max. (Nm)	PCS packing	📦
YT-78134	PZ1	25	1/4" (6.3 mm)	6.4	10	20/100
YT-78135	PZ2	25	1/4" (6.3 mm)	19.6	10	20/100
YT-78136	PZ3	25	1/4" (6.3 mm)	45.1	10	20/100



YATO	⊕	L (mm)	⊕	torque / moment obrotowy max. (Nm)	PCS packing	📦
YT-78141	T10	25	1/4" (6.3 mm)	5.9	10	20/100
YT-78142	T15	25	1/4" (6.3 mm)	8.4	10	20/100
YT-78143	T20	25	1/4" (6.3 mm)	14.7	10	20/100
YT-78144	T25	25	1/4" (6.3 mm)	21.6	10	20/100
YT-78145	T27	25	1/4" (6.3 mm)	29.4	10	20/100
YT-78146	T30	25	1/4" (6.3 mm)	45.1	10	20/100
YT-78147	T40	25	1/4" (6.3 mm)	76.5	10	20/100

YATO	⊕	L (mm)	⊕	torque / moment obrotowy max. (Nm)	PCS packing	📦
YT-78150	PH0	50	1/4" (6.3 mm)	2.1	10	20/100
YT-78151	PH1	50	1/4" (6.3 mm)	6.4	10	20/100
YT-78152	PH2	50	1/4" (6.3 mm)	19.6	10	20/100
YT-78153	PH3	50	1/4" (6.3 mm)	45.1	10	20/100



YATO	⊕	L (mm)	⊕	torque / moment obrotowy max. (Nm)	PCS packing	📦
YT-78154	PZ1	50	1/4" (6.3 mm)	6.4	10	20/100
YT-78155	PZ2	50	1/4" (6.3 mm)	19.6	10	20/100
YT-78156	PZ3	50	1/4" (6.3 mm)	45.1	10	20/100

YATO	⊕	⊕	L (mm)	⊕	torque / moment obrotowy max. (Nm)	PCS packing	📦
YT-78160	PH1	PH1	65	1/4" (6.3 mm)	6.4 / 6.4	10	20/100
YT-78161	PH2	PH2	65	1/4" (6.3 mm)	19.6 / 19.6	10	20/100
YT-78162	PH3	PH3	65	1/4" (6.3 mm)	45.1 / 45.1	10	20/100
YT-78163	PH1	PH2	65	1/4" (6.3 mm)	6.4 / 19.6	10	20/100
YT-78164	PH2	PH3	65	1/4" (6.3 mm)	19.6 / 45.1	10	20/100



YATO	⊕	⊖	L (mm)	⊕	torque / moment obrotowy max. (Nm)	PCS packing	📦
YT-78165	PH1		4.5	65 1/4" (6.3 mm)	6.4 / 6.1	10	20/100
YT-78166	PH2		5.5	65 1/4" (6.3 mm)	19.6 / 8.8	10	20/100
YT-78167	PH3		6.5	65 1/4" (6.3 mm)	45.1 / 14.7	10	20/100

YATO	⊕	L (mm)	⊕ (mm)	torque / moment obrotowy max. (Nm)	PCS packing	📦
YT-78190	M5	30	8	20.6	10	20/100
YT-78191	M6	30	8	40.2	10	20/100
YT-78192	M8	30	8	60.8	10	20/100
YT-78193	M10	30	8	156.9	8	10/50
YT-78194	M12	30	8	176.5	6	10/50

GB Screwdriver bit set
D Schraubendreherbitsatz
PL Zestaw końcówek śrubokrętowych
RUS Набор битов
CZ Sada bitů
H Bitkészlet

RO Truse bit
F Embouts de vissage
I Set punte cacciavite
E Puntas de destornilladora
CN 旋具头组套



SLIDING CARD



COLD FORGED KUTE NA ZIMNO

218Nm max.

AISI S2

HRC 58-62



10 PCS



10 PCS



10 PCS



YATO	+	L (mm)	⊘	📦
YT-0470	PZ1	25	1/4" (6.3 mm)	25/200
YT-0471	PZ2	25	1/4" (6.3 mm)	25/200
YT-0472	PZ3	25	1/4" (6.3 mm)	25/200

YATO	+	L (mm)	⊘	📦
YT-0477	PH1	50	1/4" (6.3 mm)	25/100
YT-0478	PH2	50	1/4" (6.3 mm)	25/100
YT-0479	PH3	50	1/4" (6.3 mm)	25/100
YT-0480	PH2	75	1/4" (6.3 mm)	25/100

YATO	+	L (mm)	⊘	📦
YT-0473	PH0	25	1/4" (6.3 mm)	25/200
YT-0474	PH1	25	1/4" (6.3 mm)	25/200
YT-0475	PH2	25	1/4" (6.3 mm)	25/200
YT-0476	PH3	25	1/4" (6.3 mm)	25/200



10 PCS



10 PCS



10 PCS



⊘ 5, 6 mm; ⊕ PH1, PH1, PH2, PH2;
⊕ PZ1, PZ1, PZ2, PZ2

⊘ 5, 6 mm; ⊕ PH1, PH1, PH2, PH2;
⊕ PZ1, PZ1, PZ2, PZ2

YATO	+	L (mm)	⊘	📦
YT-0481	PH2	65	1/4" (6.3 mm)	25/100

YATO	L (mm)	⊘	📦
YT-0482	25	1/4" (6.3 mm)	25/200

YATO	L (mm)	⊘	📦
YT-0483	50	1/4" (6.3 mm)	25/100

GB Screwdriver bit
D Schraubendreherbit
PL Końcówka śrubokrętowa

RUS Бит крестовая
CZ Šroubováková koncovka
H Csavarhúzóvég

RO Capăt pt. șurubelniță
F Douille tournevis
I Punta del cacciavite

E Punta de destornilladora
CN 旋具头

COLOR BOX



AISI S2

HRC 58-62

COLD FORGED KUTE NA ZIMNO



YATO	⊖	L (mm)	⊘	PCS packing	📦
YT-7803	5.5	25	1/4" (6.3 mm)	50	20/40
YT-7804	6.0	25	1/4" (6.3 mm)	50	20/40

YATO	+	L (mm)	⊘	PCS packing	📦
YT-7806	PH0	25	1/4" (6.3 mm)	50	20/40
YT-7807	PH1	25	1/4" (6.3 mm)	50	20/40
YT-7808	PH2	25	1/4" (6.3 mm)	50	20/40
YT-7809	PH3	25	1/4" (6.3 mm)	50	20/40



YATO	+	L (mm)	⊘	PCS packing	📦
YT-7810	PZ1	25	1/4" (6.3 mm)	50	20/40
YT-7811	PZ2	25	1/4" (6.3 mm)	50	20/40
YT-7812	PZ3	25	1/4" (6.3 mm)	50	20/40

YATO	⊕	L (mm)	⊘	PCS packing	📦
YT-7813	T8	25	1/4" (6.3 mm)	50	20/40
YT-7814	T10	25	1/4" (6.3 mm)	50	20/40
YT-7815	T15	25	1/4" (6.3 mm)	50	20/40



YATO	+	L (mm)	⊘	PCS packing	📦
YT-7846	PH0	50	1/4" (6.3 mm)	50	10/20
YT-7847	PH1	50	1/4" (6.3 mm)	50	10/20
YT-7848	PH2	50	1/4" (6.3 mm)	50	10/20

YATO	+	+	L (mm)	⊘	PCS packing	📦
YT-7880	PH1	PH1	65	1/4" (6.3 mm)	50	10/20
YT-7881	PH2	PH2	65	1/4" (6.3 mm)	50	10/20
YT-7882	PH3	PH3	65	1/4" (6.3 mm)	50	10/20
YT-7883	PH1	PH2	65	1/4" (6.3 mm)	50	10/20
YT-7884	PH2	PH3	65	1/4" (6.3 mm)	50	10/20



YATO	+	⊖	L (mm)	⊘	PCS packing	📦
YT-7886	PH2	5.5	65	1/4" (6.3 mm)	50	10/20
YT-7887	PH3	6.5	65	1/4" (6.3 mm)	50	10/20

GB Screwdriver bit
D Schraubendreherbit
PL Końcówka śrubokrętowa
RUS Бит крестовая
CZ Šroubováková koncovka
H Csavarhúzóvég

RO Capăt pt. șurubelniță
F Douille tournevis
I Punta del cacciavite
E Punta de destornilladora
CN 旋具头



• with limiter
• z ogranicznikiem

COLOR BOX



YATO	L (mm)	⊘	PCS packing	📦
YT-7980	25	1/4" (6.3 mm)	20	20/40

GB Screwdriver bit
D Schraubendreherbit
PL Końcówka śrubokrętowa
RUS Бит крестовая

CZ Šroubováková koncovka
H Csavarhúzóvég
RO Capăt pt. șurubelniță
F Douille tournevis

I Punta del cacciavite
E Punta de destornilladora
CN 旋具头

SLIDING
CARD



2 PCS
1/4" (6.3mm)
S2

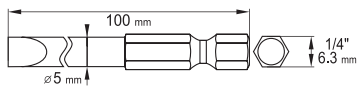

YATO	⊖	L (mm)	⊘	⊠
YT-0484	4.0	100	1/4" (6.3 mm)	25/100
	5.0	100		

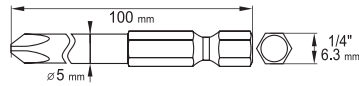

YATO	⊕	L (mm)	⊘	⊠
YT-0459	PH00	100	1/4" (6.3 mm)	25/100
	PH0	100		

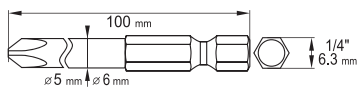

YATO	⊕	L (mm)	⊘	⊠
YT-0488	PH1	100	1/4" (6.3 mm)	25/100
	PH2	100		

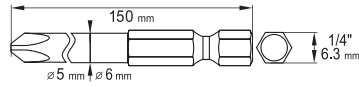

YATO	⊕	L (mm)	⊘	⊠
YT-0489	PH1	150	1/4" (6.3 mm)	25/100
	PH2	150		

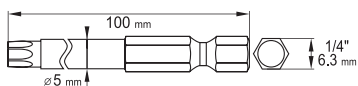

YATO	⊗	L (mm)	⊘	⊠
YT-0490	T10	100	1/4" (6.3 mm)	25/100
	T25	100		

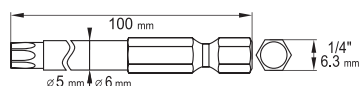

YATO	⊗	L (mm)	⊘	⊠
YT-0491	T15	100	1/4" (6.3 mm)	25/100
	T27	100		
YT-0492	T20	100	1/4" (6.3 mm)	25/100
	T30	100		

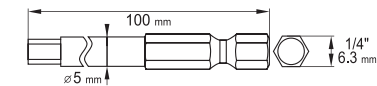

YATO	⊙	L (mm)	⊘	⊠
YT-0494	3.0	100	1/4" (6.3 mm)	25/100
	5.0	100		

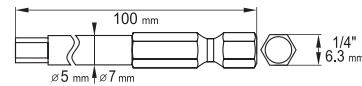
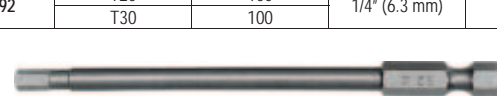

YATO	⊙	L (mm)	⊘	⊠
YT-0495	4.0	100	1/4" (6.3 mm)	25/100
	6.0	100		

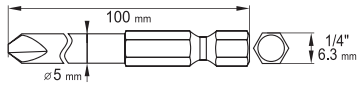

YATO	⊚	L (mm)	⊘	⊠
YT-0493	#0	100	1/4" (6.3 mm)	25/100
	#1	100		
YT-0496	#1	100	1/4" (6.3 mm)	25/100
	#3	100		

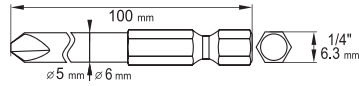
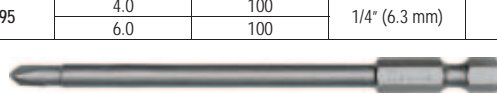

YATO	⊚	L (mm)	⊘	⊠
YT-0497	#2	100	1/4" (6.3 mm)	25/100
	#4	100		

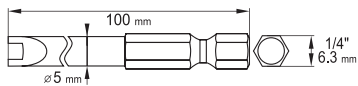

YATO	⊚	L (mm)	⊘	⊠
YT-0498	#4	100	1/4" (6.3 mm)	25/100
	#8	100		

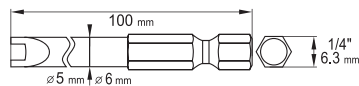

YATO	⊚	L (mm)	⊘	⊠
YT-0499	#6	100	1/4" (6.3 mm)	25/100
	#10	100		

GB Screwdriver bit set
D Schraubendreherbitsatz
PL Zestaw końcówek śrubokrętowych
RUS Набор битов
CZ Sada bitů
H Bitkészlet
RO Truse bit
F Embouts de vissage
I Set punte cacciavite
E Puntas de destornilladora
CN 旋具头组套



○ x14: L=30 mm: H4, H5, H6, H7, H8, H10, H12;
L=75 mm: H4, H5, H6, H7, H8, H10, H12; AISI S2;
○ x10: L=30 mm: M5, M6, M8, M10, M12;
L=75 mm: M5, M6, M8, M10, M12; AISI S2;
⊗ x14: L=30 mm: T20, T25, T30, T40, T45, T50, T55;
L=75 mm: T20, T25, T30, T40, T45, T50, T55; AISI S2;
⊗ x2: 1/2" (12.7 mm): 10 mm, 3/8" (9.5 mm): 10 mm; CrV 6150

21.8 Nm max. AISI S2 HRC 58-62

40 PCS HEX SPLINE TORX

METAL CASE & COLOR BOX



YATO
YT-0400 10



⊗ x6: L=30 mm: T25, T30, T40, T45, T50, T55; AISI S2;
⊗ 1/2" (12.7 mm): 10 mm; CrV 6150

7 PCS TORX

HANGING COLOR BOX

YATO
YT-0410 24/72



⊗ x14: L=30 mm: T20, T25, T30, T40, T45, T50, T55; L=75 mm: T20, T25, T30, T40, T45, T50, T55; AISI S2;
⊗ 1/2" (12.7 mm): 10 mm; CrV 6150

15 PCS TORX

METAL CASE & COLOR BOX



YATO
YT-0411 20



○ x6: L=30 mm: H4, H5, H6, H8, H10, H12 mm; AISI S2;
⊗ 1/2" (12.7 mm): 10 mm; CrV 6150

7 PCS HEX

HANGING COLOR BOX

YATO
YT-0412 24/72



○ x14: L=30 mm: H4, H5, H6, H7, H8, H10, H12 mm; L=75 mm: H4, H5, H6, H7, H8, H10, H12 mm; AISI S2;
⊗ 1/2" (12.7 mm): 10 mm; CrV 6150

15 PCS HEX

METAL CASE & COLOR BOX



YATO
YT-0413 20



○ x5: L=30 mm: M5, M6, M8, M10, M12; AISI S2;
⊗ 1/2" (12.7 mm): 10 mm; CrV 6150

6 PCS SPLINE

HANGING COLOR BOX

YATO
YT-0414 24/72



○ x10: L=30 mm: M5, M6, M8, M10, M12; L=75 mm: M5, M6, M8, M10, M12; AISI S2;
⊗ 1/2" (12.7 mm): 10 mm; CrV 6150

11 PCS SPLINE

METAL CASE & COLOR BOX



YATO
YT-0415 20



⊗ x6: L=30 mm: T25, T30, T40, T45, T50, T55; AISI S2;
⊗ 1/2" (12.7 mm): 10 mm; CrV 6150

7 PCS TORX TAMPERPROOF

HANGING COLOR BOX

YATO
YT-0416 24/72



⊗ x14: L=30 mm: T20, T25, T30, T40, T45, T50, T55; L=75 mm: T20, T25, T30, T40, T45, T50, T55; AISI S2;
⊗ 1/2" (12.7 mm): 10 mm; CrV 6150

15 PCS TORX TAMPERPROOF

METAL CASE & COLOR BOX



YATO
YT-0417 20



⊗ x7: L=30 mm: M5, M6, M7, M8, M10, M12, M14; AISI S2;
⊗ 1/2" (12.7 mm): 10 mm; CrV 6150

8 PCS RIBE

HANGING COLOR BOX

YATO
YT-0418 24/72



⊗ x14: L=30 mm: M6, M7, M8, M9, M10, M12, M14; L=75 mm: M6, M7, M8, M9, M10, M12, M14; AISI S2;
⊗ 1/2" (12.7 mm): 10 mm; CrV 6150

15 PCS RIBE

METAL CASE & COLOR BOX



YATO
YT-0419 20



⊗ x18: L=30 mm: T20, T25, T30, T40, T45, T50, T55, T60, T70; AISI S2; L=75 mm: T20, T25, T30, T40, T45, T50, T55, T60, T70; AISI S2;
⊗ x22: L=30 mm: M4, M5, M6, M7, M8, M9, M10, M11, M12, M13, M14; AISI S2; L=75 mm: M4, M5, M6, M7, M8, M9, M10, M11, M12, M13, M14; AISI S2;
⊗ x2: 1/2" (12.7 mm): 10 mm, 3/8" (9.5 mm): 10 mm; CrV 6150

42 PCS RIBE TORX TAMPERPROOF

METAL CASE & COLOR BOX



YATO
YT-0420 10

- GB Nut setter
- D Magnet-Steckschlüssel mit Adapter
- PL Nasadka magnetyczna do wkrętarki
- RUS Магнитная головка для винтовёрта
- CZ Nástrčný kľúč magnetický do vrtačky
- H Csavarbehajtó
- RO Cheie tubulara cu prindere tip mandrina
- F Douille tournevis magnétique
- I Cappuccio magnetico la vite
- E Boquilla magnética de destornilladora
- CN 磁性套筒



L(mm) **48** **CrV 6150**



YATO	Hex	PCS packing	Box
YT-1501	6	20	200/600
YT-1502	7	20	200/600
YT-1503	8	20	200/600
YT-1505	10	20	200/600
YT-1507	12	20	200/600
YT-1508	13	20	200/600

YATO	Hex	Box
YT-1511	6	100/200
YT-1512	7	100/200
YT-1513	8	100/200
YT-1515	10	100/200
YT-1517	12	100/200
YT-1518	13	100/200

- GB Screwdriver bit holder
- CZ Držák na šroubovákovekoncovky
- I Mandrino portapunta
- D Bithalter
- H Szár a csavarhúzóvégekhez
- E Mandril para puntas
- PL Uchwyt do końcówek śrubokrętowych
- RO Capete șurubelniță
- CN 旋具磁性接杆
- RUS Магнитный держатель
- F Mandrin magnétique



1/4"
6.3mm

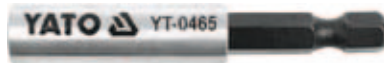

STAINLESS STEEL STAL NERZYZENNA

MAGNETIC

YATO	Hex	L (mm)	Box
YT-0465	1/4" (6.3 mm)	60	20/200

YATO	Hex	L (mm)	Box
YT-0466	1/4" (6.3 mm)	60	20/200

MAGNETIC

ELASTIC COVER

QUICK CONNECT SZYBKO-ZŁĄCZE

STAINLESS STEEL STAL NERZYZENNA



YATO	Hex	L (mm)	Box
YT-0467	1/4" (6.3 mm)	80	20/200

YATO	Hex	L (mm)	Box
YT-0468	1/4" (6.3 mm)	60	20/200

- GB Insulated hex key
- D Steckschlüssel
- PL Klucz sześciokątny izolowany
- RUS Накидной гаечный ключ угловой
- CZ Imbusové kľúče izolované
- H Imbisz kulcs
- RO Imbusuri hexagonale izolate
- F Clés allen isolée
- I Chiave esagonale isolato
- E Punta vaso aislante
- CN 绝缘内六角扳手



CrV **1000 V**

1000V VDE CERTIFICATE EN 60900:2012

YATO	Hex (mm)	a (mm)	b (mm)	Box
YT-21120	3.0	25	130	12/144
YT-21121	4.0	40	140	12/144
YT-21122	5.0	45	160	12/144
YT-21123	6.0	47	180	10/120
YT-21125	8.0	50	200	10/120
YT-21126	10.0	52	235	6/48
YT-21127	12.0	60	260	6/48

- GB Hex with ball with handle
- D Aufsteckschlüssel
- PL Klucz trzpieniowy z rączką
- RUS Ключ торцевой
- CZ Čepový klíč
- H Csapkulcs
- RO Chei cu cozi
- F Tournevis 6 pans à boule
- I Sacciavite a brugola con testina a sfera
- E Llave de mandril
- CN 球头内六角螺丝批



SVCMM
55



HRC
55-59

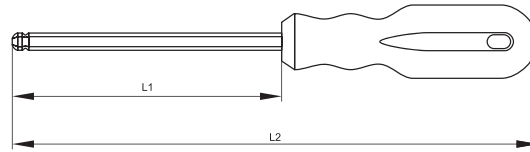

COLOR BOX



YATO	Ø (mm)	L1 (mm)	L2 (mm)	PCS packing:	Box
YT-1530	2.0	75	175	12	240
YT-1531	2.5	75	175	12	240
YT-1532	3.0	100	200	12	240
YT-1533	4.0	100	205	12	240

YATO	Ø (mm)	L1 (mm)	L2 (mm)	PCS packing:	Box
YT-1534	5.0	100	205	12	240
YT-1535	6.0	125	242	12	240
YT-1537	8.0	150	278	6	120
YT-1539	10.0	150	278	6	120

- GB T-handle key
- D T-Griff Stiftschlüssel
- PL Klucz typu „T”
- RUS Ключ Т-образный с рукояткой

- CZ Imbusový klíč s T-rukojetí
- H Imbuszkulcs T-markolattal
- RO Cheie tip „T”
- F Clé allen avec en „T”

- I Chiave a „T” per viti con impronta
- E Llave allen con mango en „T”
- CN T型内六角扳手

TIED ON CARD



S2

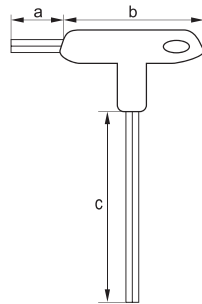

YATO	Ø (mm)	a (mm)	b (mm)	c (mm)	Box
YT-05571	2.5	13	76	100	12/240
YT-05572	3.0	13	76	100	12/240
YT-05574	4.0	13	76	140	12/240
YT-05576	5.0	17	92	140	12/144
YT-05577	6.0	17	92	170	12/144
YT-05578	7.0	17	92	170	12/144
YT-05579	8.0	22	102	200	12/96
YT-05581	10.0	22	102	200	12/96

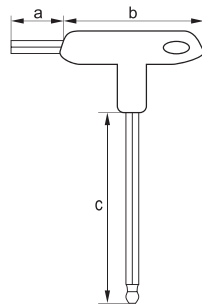

YATO	Ø (mm)	a (mm)	b (mm)	c (mm)	Box
YT-05585	2.5	13	76	100	12/240
YT-05586	3.0	13	76	100	12/240
YT-05588	4.0	13	76	140	12/240
YT-05590	5.0	17	92	140	12/144
YT-05591	6.0	17	92	170	12/144
YT-05592	7.0	17	92	170	12/144
YT-05593	8.0	22	102	200	12/96
YT-05594	10.0	22	102	200	12/96

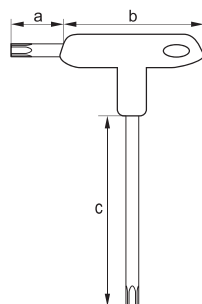

YATO	Ø (mm)	a (mm)	b (mm)	c (mm)	Box
YT-05601	T8	13	76	100	12/240
YT-05602	T9	13	76	100	12/240
YT-05603	T10	13	76	100	12/240
YT-05604	T15	13	76	100	12/240
YT-05605	T20	13	76	130	12/240
YT-05606	T25	13	76	130	12/240
YT-05607	T27	17	92	140	12/144
YT-05608	T30	17	92	170	12/144
YT-05609	T40	17	92	170	12/144
YT-05610	T45	22	102	200	12/96
YT-05611	T50	22	102	200	12/96

GB T-handle key
 D T-Griff Stiftschlüssel
 PL Klucz typu „T”
 RUS Ключ Т-образный с рукояткой

CZ Imbusový klíč s T-rukojetí
 H Imbuszkulcs T-markolattal
 RO Cheie tip „T”
 F Clé allen avec en „T”

I Chiave a „T” per viti con impronta
 E Llave allen con mango en „T”
 CN T型内六角扳手

DOUBLE
 BLISTER



S2

5

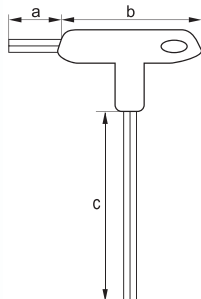

8
 PCS
 HEX

YATO	Ø (mm)	a (mm)	b (mm)	c (mm)	
YT-05583	2.5	13	76	100	12/24
	3.0	13	76	100	
	4.0	13	76	140	
	5.0	17	92	140	
	6.0	17	92	170	
	7.0	17	92	170	
	8.0	22	102	200	
10.0	22	102	200		

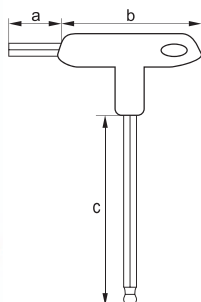

8
 PCS
 HEX
 25°

YATO	Ø (mm)	a (mm)	b (mm)	c (mm)	
YT-05597	2.5	13	76	100	12/24
	3.0	13	76	100	
	4.0	13	76	140	
	5.0	17	92	140	
	6.0	17	92	170	
	7.0	17	92	170	
	8.0	22	102	200	
10.0	22	102	200		

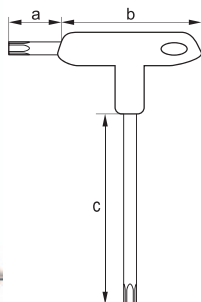

9
 PCS
 TORX
 TAMPERPROOF

YATO	Ø (mm)	a (mm)	b (mm)	c (mm)	
YT-05615	T10	13	76	100	12/24
	T15	13	76	100	
	T20	13	76	100	
	T25	13	76	140	
	T27	17	92	140	
	T30	17	92	170	
	T40	17	92	170	
	T45	22	102	200	
T50	22	102	200		

GB Hex key set
D Sechskant-Stiftschlüsselsatz
PL Zestaw kluczy imbusowych
RUS Набор шестигранников

CZ Imbusové klíče
H Imbisz kulcs
RO Chei imbus
F Set de clés Allen

I Set di chiavi a brugola
E Juego de llaves hex
CN 内六角扳手组套

PLASTIC HANGER
& SLIDING CARD



12
PCS

CrV
6150

S.A.E.

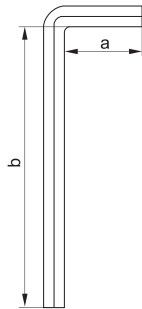

YATO	⊙	a (mm)	b (mm)	
YT-5835	1/16" (1.6 mm)	14	74	6/36
	5/64" (2.0 mm)	16	79	
	3/32" (2.4 mm)	17	83	
	7/64" (2.8 mm)	18	88	
	1/8" (3.2 mm)	19	93	
	9/64" (3.6 mm)	20	99	
	5/32" (4.0 mm)	21	105	
	3/16" (4.8 mm)	24	113	
	7/32" (5.6 mm)	25	122	
	1/4" (6.3 mm)	28	132	
	5/16" (7.9 mm)	32	150	
	3/8" (9.5 mm)	35	170	



YATO	⊙	a (mm)	b (mm)	
YT-5837	1/16" (1.6 mm)	14	74	6/36
	5/64" (2.0 mm)	16	79	
	3/32" (2.4 mm)	17	83	
	7/64" (2.8 mm)	18	88	
	1/8" (3.2 mm)	19	93	
	9/64" (3.6 mm)	20	99	
	5/32" (4.0 mm)	21	105	
	3/16" (4.8 mm)	24	113	
	7/32" (5.6 mm)	25	122	
	1/4" (6.3 mm)	28	132	
	5/16" (7.9 mm)	32	150	
	3/8" (9.5 mm)	35	170	

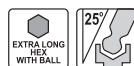
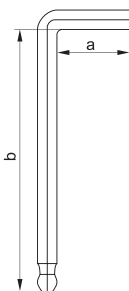

YATO	⊙	a (mm)	b (mm)	
YT-5838	1/16" (1.6 mm)	14	91	6/36
	5/64" (2.0 mm)	16	100	
	3/32" (2.4 mm)	17	110	
	7/64" (2.8 mm)	18	116	
	1/8" (3.2 mm)	19	123	
	9/64" (3.6 mm)	20	130	
	5/32" (4.0 mm)	21	132	
	3/16" (4.8 mm)	24	150	
	7/32" (5.6 mm)	25	165	
	1/4" (6.3 mm)	28	185	
	5/16" (7.9 mm)	32	200	
	3/8" (9.5 mm)	35	233	

GB Hex key set
 D Sechskant-Stiftschlüsselsatz
 PL Zestaw kluczy imbusowych
 RUS Набор шестигранников

CZ Imbusové klíče
 H Imbysz kulcs
 RO Chei imbus
 F Set de clés Allen

I Set di chiavi a brugola
 E Juego de llaves hex
 CN 内六角扳手手套

PLASTIC HANGER
 & SLIDING CARD



HEX
 CrV
 6150
 HRC
 52-55

5

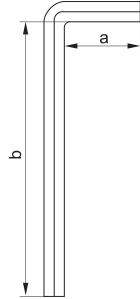

YATO	⌀ (mm)	a (mm)	b (mm)	⊠
YT-0500	1.5	15	74	6/36
	2.0	16	81	
	2.5	18	88	
	3.0	21	95	
	4.0	23	109	
	5.0	28	121	
	6.0	31	135	
	8.0	35	157	
	10.0	39	174	

9
PCS

YATO	⌀ (mm)	a (mm)	b (mm)	⊠
YT-0501	1.5	15	90	6/36
	2.0	16	96	
	2.5	18	112	
	3.0	21	125	
	4.0	23	142	
	5.0	28	157	
	6.0	31	180	
	8.0	35	201	
	10.0	39	225	

9
PCS

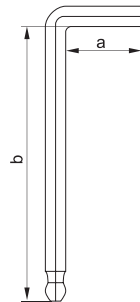

YATO	⌀ (mm)	a (mm)	b (mm)	⊠
YT-0502	2.0	16	81	6/36
	2.5	18	88	
	3.0	21	95	
	4.0	23	109	
	5.0	28	121	
	6.0	31	135	
	7.0	33	145	
	8.0	35	157	
	10.0	39	174	

9
PCS

YATO	⌀ (mm)	a (mm)	b (mm)	⊠
YT-0508	2.0	16	81	6/36
	2.5	18	88	
	3.0	21	95	
	4.0	23	109	
	5.0	28	121	
	6.0	31	135	
	7.0	33	145	
	8.0	35	157	
	10.0	39	174	
	12.0	42	180	

10
PCS



CZ Imbusové klíče
 H Imbysz kulcs
 RO Chei imbus
 F Set de clés Allen

I Set di chiavi a brugola
 E Juego de llaves hex
 CN 内六角扳手手套

GB Hex key set
 D Sechskant-Stiftschlüsselsatz
 PL Zestaw kluczy imbusowych
 RUS Набор шестигранников

POUCH



HEX
 CrV
 6150

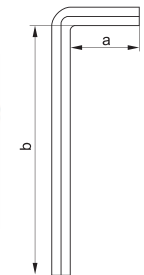
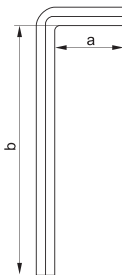

8
PCS

10
PCS

YATO	⌀ (mm)	a (mm)	b (mm)	⊠
YT-0503	2.0	14	50	12/72
	2.5	16	53	
	3.0	17	60	
	4.0	21	66	
	5.0	22	74	
	6.0	27	81	
	8.0	32	93	
	10.0	38	104	

YATO	⌀ (mm)	a (mm)	b (mm)	⊠
YT-0504	1.5	12	43	12/72
	2.0	14	50	
	2.5	16	53	
	3.0	17	60	
	4.0	21	66	
	5.0	22	74	
	6.0	27	81	
	7.0	31	86	
	8.0	32	93	
	10.0	38	104	

- GB Hex key set
D Sechskant-Stiftschlüsselsatz
PL Zestaw kluczy imbusowych
RUS Набор шестигранников
CZ Imbusové klíče
H Imbisz kulcs
RO Chei imbus
F Set de clés Allen
I Set di chiavi a brugola
E Juego de llaves hex
CN 内六角扳手组套



10
PCS



CrV
6150

HRC
52-55

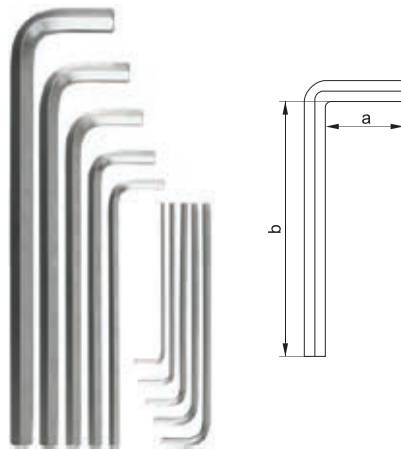

YATO	⌀ (mm)	a (mm)	b (mm)	
YT-0519	3.0	20	125	5
	4.0	25	140	
	5.0	28	160	
	5.5	30	170	
	6.0	32	180	
	8.0	35	200	
	10.0	42	220	
	12.0	49	250	
	14.0	57	285	
17.0	65	320		

- GB TORX key set
D TORX-Stiftschlüsselsatz
PL Zestaw kluczy TORX
RUS Набор ключей TORX
CZ Souprava klíčů TORX
H Kulcskészlet, TORX
RO Set de chei TORX
F Set de clés Allen
I Set di chiavi a brugola
E Juego de llaves TORX
CN 内六角扳手组套

PLASTIC
HANGER
& SLIDING
CARD

9
PCS



CrV
6150

HRC
52-55

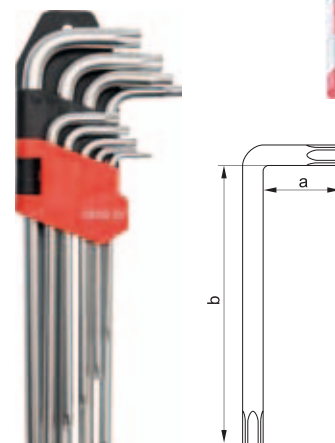

TORX TAMPERPROOF



YATO	⌀ (mm)	a (mm)	b (mm)	
YT-0511	T10	15	72	6/36
	T15	16	79	
	T20	17	86	
	T25	21	94	
	T27	24	107	
	T30	27	122	
	T40	32	133	
	T45	36	155	
	T50	38	174	

YATO	⌀ (mm)	a (mm)	b (mm)	
YT-0512	T10	15	78	6/36
	T15	16	95	
	T20	19	109	
	T25	23	124	
	T27	26	143	
	T30	27	153	
	T40	32	180	
	T45	36	200	
	T50	41	222	

- GB Hex key set
D Sechskant-Stiftschlüsselsatz
PL Zestaw kluczy imbusowych
RUS Набор шестигранников
CZ Imbusové klíče
H Imbisz kulcs
RO Chei imbus
F Set de clés Allen
I Set di chiavi a brugola
E Juego de llaves hex
CN 内六角扳手组套

PLASTIC
HANGER



S2

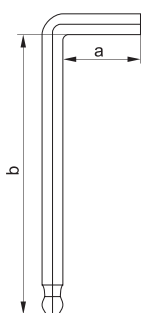

10
PCS

YATO	⌀ (mm)	a (mm)	b (mm)	
YT-0560	1.27	12	73	12/48
	1.5	14	76	
	2.0	16	82	
	2.5	18	89	
	3.0	18	99	
	4.0	21	104	
	5.0	27	115	
	6.0	32	138	
	8.0	35	161	
	10.0	38	179	

10
PCS

YATO	⌀ (mm)	a (mm)	b (mm)	
YT-0561	1.27	10	78	12/48
	1.5	12	89	
	2.0	15	98	
	2.5	17	110	
	3.0	19	124	
	4.0	23	140	
	5.0	28	159	
	6.0	32	179	
	8.0	36	198	
	10.0	50	232	

- GB TORX key set
D TORX-Stiftschlüsselsatz
PL Zestaw kluczy TORX
RUS Набор ключей TORX
CZ Souprava klíčů TORX
H Kulcskészlet, TORX
RO Set de chei TORX
F Set de clés Allen
I Set di chiavi a brugola
E Juego de llaves TORX
CN 内六角扳手组套

TORX TAMPERPROOF

PLASTIC
HANGER



S2

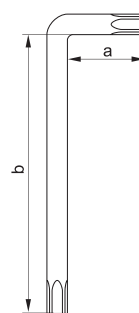

7
PCS

YATO	⌀ (mm)	a (mm)	b (mm)	
YT-0562	T9	18	78	12/48
	T10	19	85	
	T15	19	93	
	T20	19	103	
	T25	22	113	
	T27	24	123	
	T30	26	132	

9
PCS

YATO	⌀ (mm)	a (mm)	b (mm)	
YT-0563	T10	14	87	12/48
	T15	14	97	
	T20	16	108	
	T25	18	123	
	T27	23	137	
	T30	27	158	
	T40	30	177	
	T45	35	197	
	T50	41	216	

6

Pliers & pipe wrenches Szczypce i klucze do rur



Pliers, CrV Szczypce, CrV		117
--	---	-----

Combination pliers Szczypce uniwersalne.....	117
Side cutting pliers Szczypce tnące, boczne.....	117
Long nose pliers Szczypce wydłużone, proste.....	117
Bent nose pliers Szczypce wydłużone, wygięte.....	117

Pliers Szczypce		117-118
----------------------------------	---	---------

Combination pliers Szczypce uniwersalne.....	117
Side cutting pliers Szczypce tnące, boczne.....	117
Long nose pliers Szczypce wydłużone, proste.....	117
Bent nose pliers Szczypce wydłużone, wygięte.....	117
Flat nose pliers Szczypce płaskie.....	118
Round nose pliers Szczypce okrągłe.....	118
Wire stripping pliers Szczypce do ściągania izolacji.....	118
End cutting pliers Szczypce tnące, czołowe.....	118

Pliers, CrV Szczypce, CrV		118
--	---	-----

Combination pliers Szczypce uniwersalne.....	118
Side cutting pliers Szczypce tnące, boczne.....	118

Pliers Szczypce		118
----------------------------------	---	-----

Combination pliers Szczypce uniwersalne.....	118
Side cutting pliers Szczypce tnące, boczne.....	118

Mini pliers Szczypce „Mini”		119
--	---	-----

Combination pliers Szczypce uniwersalne.....	119
Side cutting pliers Szczypce tnące, boczne.....	119
Long nose pliers Szczypce wydłużone, proste.....	119
Bent nose pliers Szczypce wydłużone, wygięte.....	119
Flat nose pliers Szczypce płaskie.....	119
Round nose pliers Szczypce okrągłe.....	119
End cutting pliers Szczypce tnące, czołowe.....	119

Insulated pliers Szczypce izolowane		120
--	---	-----

Combination pliers Szczypce uniwersalne.....	120
Side cutting pliers Szczypce tnące, boczne.....	120
Long nose pliers Szczypce wydłużone, proste.....	120
Wire stripping pliers Szczypce do ściągania izolacji.....	120
Water pump pliers Szczypce nastawne.....	120
Insulated flat nose pliers Klucze płaskie izolowane.....	120

Plastics & cables cutting pliers Szczypce do cięcia plastiku i kabli		121
---	---	-----

Side cutting pliers Szczypce tnące, boczne.....	121
Long nose pliers Szczypce wydłużone, proste.....	121

Carpenter's pliers & tower pincers Obcęgi i szczypce		122
---	---	-----

Carpenter's pliers Obcęgi.....	122
Tower pincers Szczypce tynkarskie.....	122

Heavy duty side cutting pliers Szczypce tnące, boczne		122
--	---	-----

End cutting pliers Szczypce tnące czołowe		122
--	---	-----

Circlip pliers Szczypce Segera		123-124
---	---	---------

Lock grip pliers Szczypce zaciskowe		125-127
--	---	---------

Lock grip pliers Szczypce zaciskowe, uniwersalne.....	125
Welding locking pliers Szczypce zaciskowe, spawalnicze.....	126
Flat locking pliers Szczypce zaciskowe o szerokich szczękach.....	126
C-type welding locking pliers Szczypce zaciskowe, kłamrowe typu „C”.....	126
Chain locking pliers Szczypce zaciskowe z łańcuchem.....	126
Self-locking multi grip pliers Szczypce blacharskie.....	127



Profile connection & forming pliers
Szczypce do łączenia i kształtowania profili

127



Chain pipe wrenches
Klucze do rur łańcuchowe

128



Water pump pliers
Szczypce nastawne

128



Tweezers
Pęsety

129



Pipe wrenches
Klucze do rur

128



GB Combination pliers
D Kombinationszange
PL Szczypce uniwersalne
RUS Плоскогубцы универсальные
CZ Kleště kombinované
H Kombináltfogó

RO Patent universal
F Pince universelle
I Pinze universali
E Alicates universales
CN 钢丝钳

160 mm	180 mm	200 mm
HRC 44-50 BODY	HRC 58-62 CUTTER	CrV 55
DIN 5746		



HALF DOUBLE BLISTER

- application: industry
- induction hardening
- przeznaczenie: przemysł
- hartowane indukcyjnie

YATO	L (mm)	
YT-1940	160	6/60
YT-1941	180	6/60
YT-1942	200	6/36

GB Diagonal side cutting pliers
D Seitenschneider
PL Szczypce tnące boczne
RUS Бокорезы
CZ Řezací kleště boční
H Oldal csípőfogó

RO Olește tăietor
F Pince à coupe latérale
I Pinze taglianti laterali
E Alicates corte lateral
CN 斜嘴钳

160 mm	190 mm	HRC 44-50 BODY
HRC 58-62 CUTTER	CrV 55	DIN 5746



HALF DOUBLE BLISTER

- application: industry
- induction hardening
- przeznaczenie: przemysł
- hartowane indukcyjnie

YATO	L (mm)	
YT-1947	160	6/60
YT-1948	190	6/60

GB Long nose pliers
D Radiozange
PL Szczypce wydłużone proste
RUS Тонкогубцы прямые
CZ Prodloužené kleště rovné
H Rádiófogó, egyenes

RO Clește cu vârf ascuțit
F Pince prolongée
I Pinze lunghe diritte
E Alicates de punta
CN 尖嘴钳

160 mm	200 mm	HRC 44-50 BODY
HRC 58-62 CUTTER	CrV 55	DIN 5746



HALF DOUBLE BLISTER

- application: industry
- induction hardening
- przeznaczenie: przemysł
- hartowane indukcyjnie

YATO	L (mm)	
YT-1943	160	6/60
YT-1944	200	6/60

GB Bent nose pliers
D Telefonzange
PL Szczypce wydłużone wygięte
RUS Тонкогубцы изогнутые
CZ Prodloužené kleště ohnuté
H Rádió - és telefonfogó, hajlított

RO Clește cu vârf ascuțit indoit
F Pince prolongée cambrée
I Pinze a punta mezzo tonde
E Alicates de punta curvos
CN 弯嘴钳

160 mm	200 mm	HRC 44-50 BODY
HRC 58-62 CUTTER	CrV 55	DIN 5746



HALF DOUBLE BLISTER

- application: industry
- induction hardening
- przeznaczenie: przemysł
- hartowane indukcyjnie

YATO	L (mm)	
YT-1945	160	6/60
YT-1946	200	6/60

GB Combination pliers
D Kombinationszange
PL Szczypce uniwersalne
RUS Плоскогубцы универсальные
CZ Kleště kombinované
H Kombináltfogó

RO Patent universal
F Pince universelle
I Pinze universali
E Alicates universales
CN 钢丝钳

160 mm	180 mm	200 mm
DIN 5746		NICKEL IRON FINISH



HALF DOUBLE BLISTER

YATO	L (mm)	
YT-2006	160	6/60
YT-2007	180	6/60
YT-2008	200	6/36

GB Diagonal side cutting pliers
D Seitenschneider
PL Szczypce tnące boczne
RUS Бокорезы
CZ Řezací kleště boční
H Oldal csípőfogó

RO Olește tăietor
F Pince à coupe latérale
I Pinze taglianti laterali
E Alicates corte lateral
CN 斜嘴钳

160 mm	180 mm	
DIN 5746		NICKEL IRON FINISH



HALF DOUBLE BLISTER

YATO	L (mm)	
YT-2036	160	6/60
YT-2037	180	6/60

GB Long nose pliers
D Radiozange
PL Szczypce wydłużone proste
RUS Тонкогубцы прямые
CZ Prodloužené kleště rovné
H Rádiófogó, egyenes

RO Clește cu vârf ascuțit
F Pince prolongée
I Pinze lunghe diritte
E Alicates de punta
CN 尖嘴钳

160 mm	200 mm	
DIN 5746		NICKEL IRON FINISH



HALF DOUBLE BLISTER

YATO	L (mm)	
YT-2016	160	6/60
YT-2018	200	6/60

GB Bent nose pliers
D Telefonzange
PL Szczypce wydłużone wygięte
RUS Тонкогубцы изогнутые
CZ Prodloužené kleště ohnuté
H Rádió - és telefonfogó, hajlított

RO Clește cu vârf ascuțit indoit
F Pince prolongée cambrée
I Pinze a punta mezzo tonde
E Alicates de punta curvos
CN 弯嘴钳

160 mm	200 mm	
DIN 5746		NICKEL IRON FINISH



HALF DOUBLE BLISTER

YATO	L (mm)	
YT-2026	160	6/60
YT-2028	200	6/60

GB Flat nose pliers
D Elektrikerflachzange
PL Szczypce płaskie
RUS Утконосы
CZ Prodloužené kleště rovné
H Rádiófogó, egyenes

RO Clește cu vârf ascuțit
F Pince plate
I Pinze piatte
E Alicates de bocas planas
CN 平嘴钳

160 mm DIN 5745 NICKEL IRON FINISH



YATO	L (mm)	
YT-2029	160	6/60

GB Round nose pliers
D Rundzange
PL Szczypce okrągłe
RUS Круглогубцы
CZ Kleště kulaté
H Kerekcsőrű fogó

RO Patent rotund
F Pince ronde
I Pinze tonde
E Alicates de punta redonda
CN 圆嘴钳

160 mm DIN 5745 NICKEL IRON FINISH



YATO	L (mm)	
YT-2030	160	6/60

6

GB Wire stripping pliers
D Abisolierzange
PL Szczypce do ściągania izolacji
RUS Пасатижи для зачистки проводов
CZ Kleště odizolovací na drát
H Blankoló fogó
RO Decablator

F Pince à l'isolation
I Pinze spelafili
E Pinzas pelacables
CN 剥线钳

160 mm DIN 5745 NICKEL IRON FINISH



YATO	L (mm)	
YT-2031	160	6/60

GB End cutting pliers
D Vornschneider
PL Szczypce tnące czolowe
RUS Кусачки торцевые
CZ Kleště štipací čelní
H Homlokcsipő fogó
RO Clește retezat

F Coupe devant
I Pinza a taglio laterale
E Cortacables frontales
CN 顶切钳

160 mm 180 mm DIN 5748 NICKEL IRON FINISH

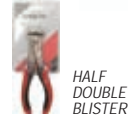

YATO	L (mm)	
YT-2066	160	6/60
YT-2067	180	6/60

GB Combination pliers
D Kombinationszange
PL Szczypce uniwersalne
RUS Плоскогубцы универсальные
CZ Kleště kombinované
H Kombináltfogó

RO Patent universal
F Pince universelle
I Pinze universali
E Alicates universales
CN 钢丝钳

160 mm 180 mm 200 mm CrV HRC 55-62



YATO	L (mm)	
YT-6600	160	6/60
YT-6601	180	6/60
YT-6602	200	6/36

GB Diagonal side cutting pliers
D Seitenschneider
PL Szczypce tnące boczne
RUS Бокорезы
CZ Řezací kleště boční
H Oldal csipőfogó

RO Olește tăietor
F Pince à coupe latérale
I Pinze taglianti laterali
E Alicates corte lateral
CN 斜嘴钳

160 mm 180 mm CrV HRC 55-62



YATO	L (mm)	
YT-6610	160	6/60
YT-6611	180	6/60

GB Diagonal side cutting pliers
D Seitenschneider
PL Szczypce tnące boczne
RUS Бокорезы
CZ Řezací kleště boční
H Oldal csipőfogó
RO Olește tăietor
F Pince à coupe latérale
I Pinze taglianti laterali
E Alicates corte lateral
CN 斜嘴钳



YATO	L (mm)	
YT-6612	180	6/60

GB Combination pliers
D Kombinationszange
PL Szczypce uniwersalne
RUS Плоскогубцы универсальные
CZ Kleště kombinované
H Kombináltfogó

RO Patent universal
F Pince universelle
I Pinze universali
E Alicates universales
CN 钢丝钳

160 mm 200 mm HIGH LEVERAGE ZWIERSZONA SIŁA NACISKU



YATO	L (mm)	
YT-6581	160	6/60
YT-6582	200	6/36

GB Diagonal side cutting pliers
D Seitenschneider
PL Szczypce tnące boczne
RUS Бокорезы
CZ Řezací kleště boční
H Oldal csipőfogó

RO Olește tăietor
F Pince à coupe latérale
I Pinze taglianti laterali
E Alicates corte lateral
CN 斜嘴钳

160 mm HIGH LEVERAGE ZWIERSZONA SIŁA NACISKU





YATO	L (mm)	
YT-6583	160	6/60

GB Combination pliers
D Kombinationszange
PL Szczypce uniwersalne
RUS Плоскогубцы универсальные
CZ Kleště kombinované
H Kombináltfogó
RO Patent universal
F Pince universelle
I Pinze universali
E Alicates universales
CN 钢丝钳

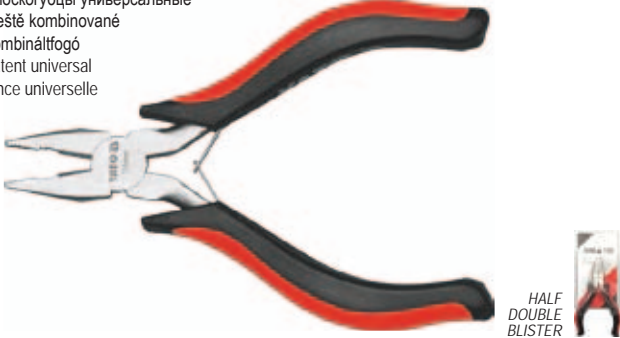
115 mm **NICKEL IRON FINISH**



HALF DOUBLE BLISTER



YATO 	L (mm)	
YT-2080	115	6/120

GB Diagonal side cutting pliers
D Seitenschneider
PL Szczypce tnące boczne
RUS Бокорезы
CZ Rezací kleště boční
H Oldal csípőfogó
RO Olește tăietor
F Pince à coupe latérale
I Pinze taglianti laterali
E Alicates corte lateral
CN 斜嘴钳

115 mm **NICKEL IRON FINISH**



HALF DOUBLE BLISTER

YATO 	L (mm)	
YT-2081	115	6/120

GB Long nose pliers
D Radiozange
PL Szczypce wydłużone proste
RUS Тонкогубцы прямые
CZ Prodloužené kleště rovné
H Rádiófogó, egyenes
RO Clește cu vârf ascuțit
F Pince prolongée
I Pinze lunghe diritte
E Alicates de punta
CN 尖嘴钳

115 mm **NICKEL IRON FINISH**



HALF DOUBLE BLISTER



YATO 	L (mm)	
YT-2083	115	6/120

GB Bent nose pliers
D Telefonzange
PL Szczypce wydłużone wygięte
RUS Тонкогубцы изогнутые
CZ Prodloužené kleště ohnuté
H Rádió - és telefonfogó, hajlított
RO Clește cu vârf ascuțit îndoit
F Pince prolongée cambrée
I Pinze a punta mezza tonde
E Alicates de punta curvos
CN 弯嘴钳

115 mm **NICKEL IRON FINISH**



HALF DOUBLE BLISTER

YATO 	L (mm)	
YT-2084	115	6/120

GB Flat nose pliers
D Elektrikerflachzange
PL Szczypce płaskie
RUS Утконосы
CZ Prodloužené kleště rovné
H Rádiófogó, egyenes
RO Clește cu vârf ascuțit
F Pince plate
I Pinze piatte
E Alicates de bocas planas
CN 平嘴钳

115 mm **NICKEL IRON FINISH**



HALF DOUBLE BLISTER



YATO 	L (mm)	
YT-2085	115	6/120

GB Round nose pliers
D Rundzange
PL Szczypce okrągłe
RUS Круглогубцы
CZ Kleště kulaté
H Kerekcsőrű fogó
RO Patent rotund
F Pince ronde
I Pinze tonde
E Alicates de punta redonda
CN 圆嘴钳

115 mm **NICKEL IRON FINISH**



HALF DOUBLE BLISTER

YATO 	L (mm)	
YT-2086	115	6/120

GB End cutting pliers
D Vornschnaider
PL Szczypce tnące czolowe
RUS Кусачки торцевые
CZ Kleště štípačí čelní
H Homlokcsípő fogó
RO Clește retezat
F Coupe devant
I Pinza a taglio laterale
E Cortacables frontales
CN 顶切钳

115 mm **NICKEL IRON FINISH**



HALF DOUBLE BLISTER

YATO 	L (mm)	
YT-2082	115	6/120

GB Combination pliers
 D Kombinationszange
 PL Szczypce uniwersalne
 RUS Плоскогубцы универсальные
 CZ Kleště kombinované
 H Kombináltfogó
 RO Patent universal
 F Pince universelle
 I Pinze universali
 E Alicates universales
 CN 钢丝钳

160 mm 180 mm 200 mm CrV 1000 V 



HALF DOUBLE BLISTER

YATO	L (mm)	
YT-21151	160	6/36
YT-21152	180	6/36
YT-21153	200	6/36

1000V
 VDE CERTIFICATE
 EN 60900:2012

GB Diagonal side cutting pliers
 D Seitenschneider
 PL Szczypce tnące boczne
 RUS Бокорезы
 CZ Řezací kleště boční
 H Oldal csípőfogó
 RO Olește tăietor
 F Pince à coupe latérale
 I Pinze taglianti laterali
 E Alicates corte lateral
 CN 斜嘴钳

160 mm 180 mm CrV 1000 V 



HALF DOUBLE BLISTER

YATO	L (mm)	
YT-21158	160	6/36
YT-21159	180	6/36

1000V
 VDE CERTIFICATE
 EN 60900:2012

GB Long nose pliers
 D Radiozange
 PL Szczypce wydłużone proste
 RUS Тонкогубцы прямые
 CZ Prodloužené kleště rovné
 H Rádiófogó, egyenes
 RO Clește cu vârf ascuțit
 F Pince prolongée
 I Pinze lunghe diritte
 E Alicates de punta
 CN 尖嘴钳

160 mm 200 mm CrV 1000 V 



HALF DOUBLE BLISTER

YATO	L (mm)	
YT-21154	160	6/36
YT-21155	200	6/36

1000V
 VDE CERTIFICATE
 EN 60900:2012

GB Wire stripping pliers
 D Abisolierzange
 PL Szczypce do ściągania izolacji
 RUS Пасатижи для зачистки проводов
 CZ Kleště odizolovací na drát
 H Blankoló fogó
 RO Decablator
 F Pince à l'isolation
 I Pinze spelafili
 E Pinzas pelacables
 CN 剥线钳

160 mm CrV 1000 V 



HALF DOUBLE BLISTER

YATO	L (mm)	
YT-21160	160	6/36

1000V
 VDE CERTIFICATE
 EN 60900:2012

GB Water pump pliers
 D Wasserpumpenzange
 PL Szczypce nastawne
 RUS Клещи переставные
 CZ Keleště siko
 H Vízpumpafogó
 RO Clește papagal

F Pince réglable
 I Pinze regolabili
 E Alicates de fontanero ajustables
 CN 水泵钳

250 mm CrV 1000 V 



HALF DOUBLE BLISTER

YATO	L (mm)	
YT-21161	250	6/24

1000V
 VDE CERTIFICATE
 EN 60900:2012

GB Insulated flat nose pliers
 D Sicherheitsklammer mit Haken
 PL Szczypce płaskie izolowane
 RUS Клещи для замены предохранителей
 CZ Izolované kleště s plochými čelistmi
 H Rugós szorító
 RO Patent izolat
 F Pince plate isolée
 I Pinze plate plastica isolati
 E Alicates punta plana aislantes
 CN 绝缘平嘴钳

200 mm CrV 1000 V 



YATO	L (mm)	
YT-21191	200	6/48

1000V
 VDE CERTIFICATE
 EN 60900:2012



GB Diagonal side cutting pliers
D Seitenschneider
PL Szczypce tnące boczne
RUS Бокорезы
CZ Řezací kleště boční
H Oldal csípőfogó

RO Olește tăietor
F Pince à coupe latérale
I Pinze taglianti laterali
E Alicates corte lateral
CN 斜嘴钳

125 mm CrV 60
HRC CUTTER 56-62 HRC BODY 43-48
FOR PLASTIC max. ∅ 3 mm



SLIDING CARD 

YATO 	L (mm)	
YT-1950	125	6/120



GB Diagonal side cutting pliers
D Seitenschneider
PL Szczypce tnące boczne
RUS Бокорезы
CZ Řezací kleště boční
H Oldal csípőfogó

RO Olește tăietor
F Pince à coupe latérale
I Pinze taglianti laterali
E Alicates corte lateral
CN 斜嘴钳

150 mm CrV 60
HRC CUTTER 56-62 HRC BODY 43-48
FOR PLASTIC max. ∅ 5 mm



SLIDING CARD 

YATO 	L (mm)	
YT-1951	150	6/120



GB Diagonal side cutting pliers
D Seitenschneider
PL Szczypce tnące boczne
RUS Бокорезы
CZ Řezací kleště boční
H Oldal csípőfogó

RO Olește tăietor
F Pince à coupe latérale
I Pinze taglianti laterali
E Alicates corte lateral
CN 斜嘴钳

180 mm CrV 60
HRC CUTTER 56-62 HRC BODY 43-48
FOR PLASTIC max. ∅ 6 mm



SLIDING CARD 

YATO 	L (mm)	
YT-1952	180	6/60



GB Diagonal side cutting pliers
D Seitenschneider
PL Szczypce tnące boczne
RUS Бокорезы
CZ Řezací kleště boční
H Oldal csípőfogó

RO Olește tăietor
F Pince à coupe latérale
I Pinze taglianti laterali
E Alicates corte lateral
CN 斜嘴钳

100 mm CrV 60
HRC CUTTER 56-62 HRC BODY 43-48
FOR CABLE CUTTING max. ∅ 1.0 mm
COPPER max. ∅ 1.8 mm



SLIDING CARD 

YATO 	L (mm)	
YT-1953	100	6/120



GB Diagonal side cutting pliers
D Seitenschneider
PL Szczypce tnące boczne
RUS Бокорезы
CZ Řezací kleště boční
H Oldal csípőfogó

RO Olește tăietor
F Pince à coupe latérale
I Pinze taglianti laterali
E Alicates corte lateral
CN 斜嘴钳

125 mm CrV 60
HRC CUTTER 56-62 HRC BODY 43-48
FOR CABLE CUTTING max. ∅ 1.2 mm
COPPER max. ∅ 2.0 mm



SLIDING CARD 

YATO 	L (mm)	
YT-1954	125	6/120



GB Long nose pliers
D Radiozange
PL Szczypce wydłużone proste
RUS Тонкогубцы прямые
CZ Prodloužené kleště rovné
H Rádiófogó, egyenes

RO Clește cu vârf ascuțit
F Pince prolongée
I Pinze lunghe diritte
E Alicates de punta
CN 尖嘴钳

150 mm CrV 60
HRC CUTTER 56-62 HRC BODY 43-48
STEEL max. ∅ 1.5 mm
COPPER max. ∅ 2.6 mm



SLIDING CARD 

YATO 	L (mm)	
YT-1956	150	6/120

GB Carpenter's pliers
D Kneifzange
PL Obcegi
RUS Клещи строительные

CZ Kleště
H Harapófógó
RO Cleste cuie
F Tenailles

I Tenaglie
E Tenazas
CN 胡桃钳

160 mm 180 mm 200 mm DIN 5748 NICKEL IRON FINISH



HALF DOUBLE BLISTER



YATO	L (mm)	
YT-2046	160	6/60
YT-2047	180	6/60
YT-2048	200	6/60

GB Tower pincers
D Beisszange
PL Obcegi tynkarskie
RUS Клещи штукатурные

CZ Kleště štípací čelní
H Rabitzfógó
RO Cleste pt. cuie
F Tenaille russe

I Tenaglie tronchesi
E Tenazas de enlucido
CN 扎线钳

200 mm 250 mm 275 mm DIN 5748 NICKEL IRON FINISH



HALF DOUBLE BLISTER



YATO	L (mm)	
YT-2058	200	6/60
YT-2060	250	6/36
YT-2061	275	6/36

GB Tower pincers
D Beisszange
PL Obcegi tynkarskie
RUS Клещи штукатурные

CZ Kleště štípací čelní
H Rabitzfógó
RO Cleste pt. cuie
F Tenaille russe

I Tenaglie tronchesi
E Tenazas de enlucido
CN 扎线钳

250 mm HRC 44-50 BODY HRC 58-62 CUTTER CrV 55 DIN 5746



HALF DOUBLE BLISTER



YATO	L (mm)	
YT-1949	250	6/36

GB Heavy duty side cutting pliers
D Seitenschneider, Schwer Typ
PL Szczypce tnące boczne
RUS Бокорезы усиленные
CZ Řezací kleště boční

H Oldal csípófógó
RO Olește tăietor
F Pince à coupe latérale
I Pinze taglianti laterali

E Alicates de corte lateral tipo pesado
CN 重型斜口钳

180 mm DIN 5749 NICKEL IRON FINISH



HALF DOUBLE BLISTER

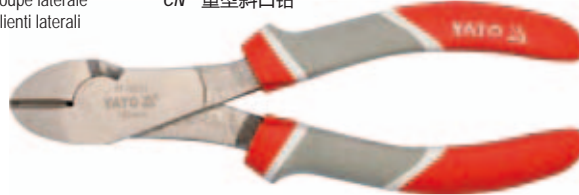

YATO	L (mm)	
YT-2039	180	6/60

GB Carpenter's pliers
D Kneifzange
PL Obcegi
RUS Клещи строительные

CZ Kleště
H Harapófógó
RO Cleste cuie
F Tenailles

I Tenaglie
E Tenazas
CN 胡桃钳

150 mm 175 mm 200 mm CrV 50 HRC 55-60 HEAD GLOWECA



SLIDING CARD



YATO	L (mm)	cold rolled steel (mm) stal walcowana na zimno (mm)	
YT-2050	150	1.5	6/60
YT-2051	175	1.8	6/60
YT-2052	200	2.0	6/48

GB Tower pincers
D Beisszange
PL Obcegi tynkarskie
RUS Клещи штукатурные

CZ Kleště štípací čelní
H Rabitzfógó
RO Cleste pt. cuie
F Tenaille russe

I Tenaglie tronchesi
E Tenazas de enlucido
CN 扎线钳

225 mm 250 mm 275 mm CrV 50 HRC 55-62 HEAD GLOWECA



SLIDING CARD



YATO	L (mm)	cold rolled steel (mm) stal walcowana na zimno (mm)	
YT-2055	225	1.8	6/60
YT-2056	250	2.0	6/48
YT-2057	275	2.2	6/24

GB End cutting pliers
D Vornschneider
PL Szczypce tnące czolowe

RUS Кусачки торцевые
CZ Kleště štípací čelní
H Homlokcsípó fogó

RO Cleste retezat
F Coupe devant
I Pinza a taglio laterale

E Cortacables frontales
CN 顶切钳

150 mm 175 mm 200 mm CrV 50 HRC 55-60 HEAD GLOWECA



SLIDING CARD











YATO	L (mm)	cold rolled steel (mm) stal walcowana na zimno (mm)	
YT-2063	175	1.5	6/48
YT-2064	200	1.8	6/48



- GB Circlip pliers
D Seegeringgzange
PL Szczypce Segera
RUS Съёмник стопорных колец
CZ Kleště Segera
H Segerfogó belső
RO Clește Seger
- F Pince pour anneau de retenue seeger
I Pinze Seger
E Alicates Seger
CN 5件套卡簧钳

5 PCS 160 mm \varnothing mm 10-50

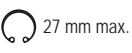

		23 mm max.		20 mm max.
		28 mm max.		23 mm max.
		30 mm max.		27 mm max.



YATO 	L (mm)	
YT-2130	160	20/60



- GB Circlip pliers
D Seegeringgzange
PL Szczypce Segera
RUS Съёмник стопорных колец
CZ Kleště Segera
H Segerfogó belső
- RO Clește Seger
F Pince pour anneau de retenue seeger
I Pinze Seger
E Alicates Seger
CN 直嘴轴用挡圈钳



SLIDING CARD





180 mm HRC 42-48 CrV 50



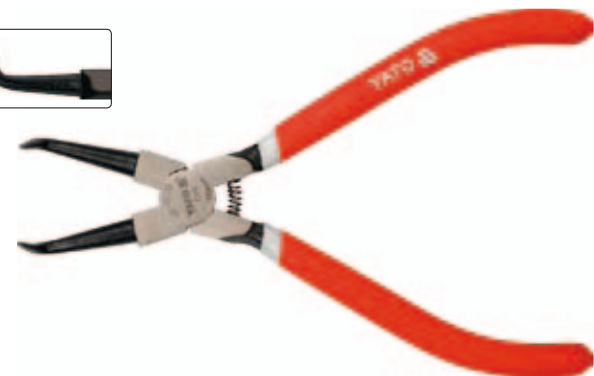

YATO 	L (mm)	
YT-2136	180	6/24

YATO 	L (mm)	
YT-2138	180	6/24



YATO 	L (mm)	
YT-2137	180	6/24

YATO 	L (mm)	
YT-2139	180	6/24

GB Circlip pliers
 D Seegeringgzange
 PL Szczypce Segera
 RUS Съёмник стопорных колец
 CZ Kleště Segera
 H Segerfogó béső
 RO Clește Seger
 F Pince pour anneau de retenue seeger
 I Pinze Seger
 E Alicates Seger
 CN 直嘴轴用挡圈钳

SLIDING CARD



150 mm
 200 mm
 CrV
 NICKEL IRON FINISH



YATO	L (mm)	
YT-2140	150	6/120
YT-2144	200	6/60



YATO	L (mm)	
YT-2141	150	6/120
YT-2145	200	6/60



YATO	L (mm)	
YT-2142	150	6/60
YT-2146	200	6/60



YATO	L (mm)	
YT-2143	150	6/120
YT-2147	200	6/60

GB Circlip pliers
 D Seegeringgzange
 PL Szczypce Segera
 RUS Съёмник стопорных колец
 CZ Kleště Segera
 H Segerfogó béső
 RO Clește Seger
 F Pince pour anneau de retenue seeger
 I Pinze Seger
 E Alicates Seger
 CN 直嘴轴用挡圈钳

SLIDING CARD



225 mm
 325 mm
 NICKEL FINISH
 CrV



YATO	L (mm)	
YT-1988	225	6/60
YT-1992	325	6/48

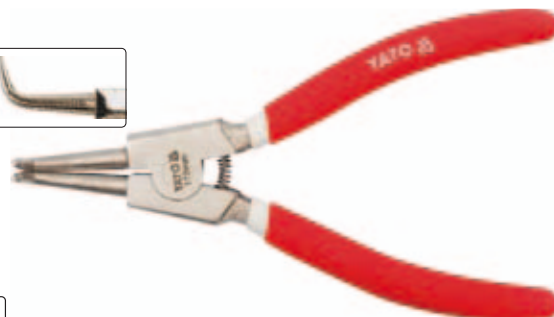

YATO	L (mm)	
YT-1989	225	6/60
YT-1993	325	6/48



YATO	L (mm)	
YT-1990	225	6/60
YT-1994	325	6/48



YATO	L (mm)	
YT-1991	225	6/60
YT-1995	325	6/48

GB Lock grip pliers
D Gripzange
PL Szczypce Morse'a
RUS Зажим ручной
CZ Kleště Morse'a
H Morse fogó

RO Clește Morse
F Pincés de serrage Morse
I Pinze Morse
E Alicates Morse
CN 圓口大力鉗

HALF
DOUBLE
BLISTER



CrV



140 mm
240 mm
180 mm
WR TYPE

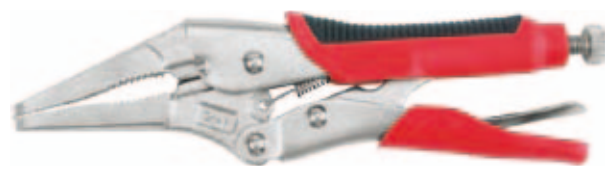

165 mm
220 mm
CD TYPE

YATO	L (mm)	
YT-2151	140	6/48
YT-2152	180	6/36
YT-2153	240	6/36

YATO	L (mm)	
YT-2155	165	6/48
YT-2156	220	6/36

GB Locking pliers
D Klemmzange
PL Szczypce zaciskowe
RUS Клещи давяльные

CZ Kleště samosvorné
H Patentfogó
RO Clește de strângere
F Pincés de serrage Morse

I Pinze Morse
E Pinzas de tornillo (de apriete)
CN 圓口大力鉗

HALF
DOUBLE
BLISTER



CrMo

6



125 mm



250 mm

YATO	L (mm)	
YT-2449	125	6/24

YATO	L (mm)	
YT-2453	250	6/24



180 mm



150 mm

YATO	L (mm)	
YT-2450	180	6/24

YATO	L (mm)	
YT-2459	150	6/24



250 mm



225 mm

YATO	L (mm)	
YT-2451	250	6/24

YATO	L (mm)	
YT-2460	225	6/24



180 mm



YATO	L (mm)	
YT-2452	180	6/24

GB Locking pliers
D Klemmzange
PL Szczypce zaciskowe
RUS Клещи давяльные
CZ Kleště samosvorné

H Patentfogó
RO Clește de strângere
F Pince de serrage courte avec blocage
I Pinze di bloccaggio

E Pinzas de tornillo (de apriete)
CN 大力鉗

HALF
DOUBLE
BLISTER



250 mm

0-42 mm

CrMo



YATO	L (mm)	
YT-2473	250	6/24

YATO	L (mm)	
YT-2476	250	6/24

- GB Sliding arm welding locking pliers
- D Parallel-gripzange
- PL Szybkonastawne szczypce spawalnicze
- RUS Образная струбцина с захватом
- CZ Paralelné samosvorné kleště
- H Szorítórúdas önzáró fogó
- RO Clește de mana cu prindere tip menghina
- F Pince-étai - serre-joint coulissant
- I Scorrevole pinze di bloccaggio di saldatura braccio
- E Pinzas de presión tipo sargento
- CN C型滑杆大力钳

260 mm 0-150 mm

QUICK-ADJUSTMENT SZYBKONASTAWNY



HALF DOUBLE BLISTER

YATO	L (mm)	
YT-21570	260	2/16

- GB C-type welding locking pliers
- D Klemm- und Klammerzange vom Typ „C“
- PL Szczypce zaciskowe klamrowe typu „C“
- RUS Клещи давяльные типа „С“
- CZ Kleště samosvorné upínací typu „C“
- H „C“ fogó

- RO Clește de strângere cu clemă tip „C“
- F Pince de serrage type „C“
- I Pinze di bloccaggio tipo „C“
- E Pinzas de tornillo (de apriete) de grapa tipo „C“
- CN C型大力钳



YATO	L (mm)	
YT-2466	280	6/24

- GB Welding locking pliers
- D Klemmzange zum Schweißen
- PL Szczypce zaciskowe spawalnicze
- RUS Клещи давяльные сварочные
- CZ Kleště samosvorné svářečské
- H Hegesztő fogó
- RO Clește de strângere pt. sudură
- F Pince de serrage pour soudeur
- I Pinze di bloccaggio per saldatura
- E Pinzas de tornillo (de apriete) para soldar
- CN 焊接用大力钳

HALF DOUBLE BLISTER

225 mm

TYPE U



YATO	L (mm)	
YT-2461	225	6/24

- GB Flat locking pliers
- D Klemmzange mit breiten Backen
- PL Szczypce zaciskowe o szerokich szczękach
- RUS Клещи давяльные с широкими губками
- CZ Kleště samosvorné se širokými čelistmi
- H Lapos fogó
- RO Clește de strângere plat / patent
- F Pince de serrage large
- I Pinze con ganasce piane e paletta
- E Pinzas de tornillo (de apriete) con mordazas anchas
- CN 铁皮大力钳

HALF DOUBLE BLISTER

200 mm

0-12.7 mm

78 mm



YATO	L (mm)	
YT-2463	200	6/24

HALF DOUBLE BLISTER

280 mm

0-100 mm

TYPE C



YATO	L (mm)	
YT-2468	280	6/24

- GB Chain locking pliers
- D Klemmzange mit Kette
- PL Szczypce zaciskowe z łańcuchem
- RUS Клещи давяльные с цепью
- CZ Kleště samosvorné s řetězem
- H Láncos csőfogó
- RO Clește de strângere cu lanț
- F Pince de serrage avec une chaîne
- I Pinze di bloccaggio con la catena
- E Pinzas de tornillo (de apriete) con cadena
- CN 链条大力钳

HALF DOUBLE BLISTER

500 mm

40 Mn



YATO		
YT-2469		6/24

- GB Self-locking multi grip pliers
D Grip-Festhaltezange
PL Szczypce blacharskie
RUS Зажим ручной сварочный для закрепления лент и профилей
CZ Kleště klempířské samodržící
H Őnzáró rögzítőfogó
RO Cleste autoblocant pt. tinichigerie
F Pince pour tôle
I Pinze per lamiera
E Pinzas de chapa
CN 多功能大力钳



SLIDING CARD



CrMo





200 mm 0-15 mm 70 mm TYPE W

YATO 	L (mm)	
YT-2160	200	12/24





230 mm 0-15 mm 45 mm TYPE JJ

YATO 	L (mm)	
YT-2161	230	12/24





215 mm 0-10 mm 45 mm TYPE LL

YATO 	L (mm)	
YT-2162	215	12/36



210 mm 0-15 mm 25 mm TYPE J

YATO 	L (mm)	
YT-2163	210	12/36

- GB Profile connection pliers
D Zange zum Verbinden der Profile
PL Szczypce do łączenia profili
RUS Щипцы для соединения профилей
CZ Kleště ke spojování profilů
H Profilgyesítő fogó
RO Cleste pt. îmbinarea profilelor
F Pince pour sertir les profiles
I Pinze per la unione profili
E Pinzas para conectar perfiles
CN 龙骨钳

SLIDING CARD





SECTION THICKNESS GRUBOSC PROFILU 0,5-0,8 mm

275 mm

A380 ALLOY (HEAD)

GR15 BEARING STEEL (PUNCH)





YATO 	L (mm)	
YT-5130	275	6/24

345 mm

65 Mn MATERIAL OF PUNCH PUNKTAK



YATO 	L (mm)	
YT-5131	345	6/24

- GB Profile forming pliers
D Zange zur Formgebung der Profile
PL Szczypce do kształtowania profili
RUS Щипцы для формировки профилей
CZ Kleště k tvarování profilů
H Profilformázó fogó
RO Cleste pt. modelarea profilelor
F Pince pour former les profiles
I Pinze per la formazione di profili
E Pinzas para formar perfiles
CN 龙骨钳



SLIDING CARD



210 mm



80x35 mm JAWS SZCZĘKI



YATO 	L (mm)	
YT-5140	210	2/12



80x35 mm JAWS SZCZĘKI



YATO 	L (mm)	
YT-5141	210	2/12

150x35 mm JAWS SZCZĘKI



YATO 	L (mm)	
YT-5142	210	2/12

GB Water pump pliers
 D Wasserpumpenzange
 PL Szczypce nastawne
 RUS Ключи переставные
 CZ Keleště siko
 H Vízpumpafagó

RO Cleste papagal
 F Pince réglable
 I Pinze regolabili
 E Alicates de fontanero ajustables
 CN 水泵钳

250 mm 300 mm CrV



YATO	L (mm)	
YT-2090	250	6/36
YT-2091	300	6/36

GB Water pump pliers
 D Wasserpumpenzange
 PL Szczypce nastawne
 RUS Ключи переставные
 CZ Keleště siko
 H Vízpumpafagó

RO Cleste papagal
 F Pince réglable
 I Pinze regolabili
 E Alicates de fontanero ajustables
 CN 水泵钳

250 mm CrV

JAW WIDTH SZEROKOSC SZCZEK 6 mm
 WORKING RANGE ADJUSTMENT REGULACJA ZAKRESU PRACY
 STRENGTHENED JAWS WZMOCNIONA KONSTRUKCJA



YATO	L (mm)	
YT-20911	250	10/50

GB Pipe wrench
 D Rohrschlüssel
 PL Klucz do rur
 RUS Ключ трубный

CZ Klíč součásti na trubky
 H Csőkulcs
 RO Cheie reglabila pt. tevi

F Clé aux tubes
 I Chiave per tubi
 E Llave para tubos
 CN 铝合金管钳

CrMo

HRC 55-60

Al HANDLE



YATO	size / rozmiar	max. pipe diameter / max. średnica rury	
YT-2482	14" (350 mm)	2" (50 mm)	6/12
YT-2483	18" (450 mm)	2.5" (63 mm)	2/10
YT-2484	24" (600 mm)	3" (75 mm)	2/6
YT-2485	36" (900 mm)	5" (125 mm)	3

GB Pipe wrench
 D Rohrschlüssel
 PL Klucz do rur

RUS Ключ трубный
 CZ Klíč součásti na trubky

H Csőkulcs
 RO Cheie reglabila pt. tevi
 F Clé aux tubes

I Chiave per tubi
 E Llave para tubos
 CN 铝合金管钳

HRC 55-60

Al HANDLE

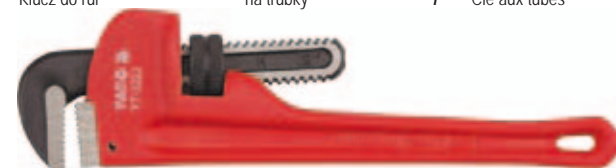

GB Water pump pliers
 D Wasserpumpenzange
 PL Szczypce nastawne
 RUS Ключи переставные
 CZ Keleště siko
 H Vízpumpafagó

RO Cleste papagal
 F Pince réglable
 I Pinze regolabili
 E Alicates de fontanero ajustables
 CN 水泵钳



250 mm

NICKEL IRON FINISH

YATO	L (mm)	
YT-2069	250	6/36



YATO	L (mm)	
YT-2070	250	6/24

GB Pipe wrench
 D Rohrschlüssel
 PL Klucz do rur
 RUS Ключ трубный

CZ Klíč součásti na trubky
 H Csőkulcs
 RO Cheie reglabila pt. tevi

F Clé aux tubes
 I Chiave per tubi
 E Llave para tubos
 CN 铝合金管钳

CrMo

HRC 55-60



YATO	size / rozmiar	max. pipe diameter / max. średnica rury	
YT-2488	10" (250 mm)	1" (25 mm)	6/18
YT-2489	12" (300 mm)	1.5" (38 mm)	6/12
YT-2490	14" (350 mm)	2" (50 mm)	2/10
YT-2491	18" (450 mm)	2.5" (63 mm)	3/6
YT-2492	24" (600 mm)	3" (75 mm)	2/4
YT-2493	36" (900 mm)	5" (125 mm)	1
YT-2494	48" (1200 mm)	6" (150 mm)	1

GB Pipe wrench
 D Rohrschlüssel
 PL Klucz do rur
 RUS Ключ трубный
 CZ Klíč součásti na trubky

H Csőkulcs
 RO Cheie reglabila pt. tevi
 F Clé serre-tube
 I Chiave per tubi

E Llave para tubos
 CN 铝合金管钳

HRC 55-60

OFFSET TYPE



YATO	size / rozmiar	max. pipe diameter / max. średnica rury	
YT-2201	10" (250 mm)	1" (25 mm)	6/36
YT-2203	14" (350 mm)	1.5" (38 mm)	4/16
YT-2204	18" (450 mm)	2" (50 mm)	3/12
YT-2205	24" (600 mm)	2.5" (63 mm)	3/6
YT-2206	36" (900 mm)	4" (100 mm)	2/4

GB Chain pipe wrench
 D Kettenrohrzange
 PL Klucz łańcuchowy do rur
 RUS Ключ цепной для труб
 CZ Klíč řetězový na trubky
 H Láncos csőfagó

RO Cheie reglabila pt. tevi cu lant
 F Clé à chaîne
 I Chiave a catena per tubi
 E Llave de cadena
 CN 链条管子钳

SLIDING CARD

4" 100 mm

300 mm

INDUCTION HARDENED TEETH ZEBY HARTYJANE INDUKCYJNE
 ADJUSTABLE WORKING RANGE REGULOVANY ZAKRES PRACY



YATO	L (mm)	max. pipe diameter / max. średnica rury	
YT-22260	300	4" (100 mm)	6/24

GB Tweezer CZ Pinzeta I Pinza
D Pinzette H Csipesz E Pinzas
PL Pęseta RO Pensetă CN 镊子
RUS Пинцет F Pince

SLIDING
CARD





302
STAINLESS
STEEL
STAL
NIEODŻEWNA

ANTI
MAGNETIC
ANTYMAG-
NETYCZNA

ANTIACID
KWASO-
ODPORNA





140
mm **HRC**
30

YATO 	L (mm)	
YT-6903	140	20/480





115
mm **HRC**
30

YATO 	L (mm)	
YT-6907	115	20/480



140
mm **HRC**
40





















YATO 	L (mm)	
YT-6916	140	20/480

Memo

7

Electrician tools Narzędzia dla elektryków



Insulated screwdrivers Wkrętaki izolowane		132-133	Insulated hex keys Klucze imbusowe izolowane		137
Insulated slotted screwdrivers Wkrętaki izolowane płaskie		132	Insulated clamps Ściski izolowane		138
Insulated phillips screwdrivers Wkrętaki izolowane krzyżakowe		132	Crimping pliers & sets Szcypce do zaciskania konektorów i zestawy		138-140
Insulated Pozidrive screwdrivers Wkrętaki izolowane „Pozidrive”		132	Hydraulic pliers Ręczne praski hydrauliczne		141
Insulated screwdriver sets Komplety wkrętek izolowanych		132	Wire strippers Ściągacze izolacji		141-143
Insulated pliers Szcypce izolowane		134	Electrical cutters Obcinaki elektryczne		143-144
Combination pliers Szcypce uniwersalne		134	Cable cutters Nożyce do kabli		144-145
Side cutting pliers Szcypce tnące, boczne		134	Electric meters & voltage testers Mierniki elektryczne i próbniki napięcia		146
Long nose pliers Szcypce wydłużone, proste		134	Multimeters Mierniki		147
Wire stripping pliers Szcypce do ściągania izolacji		134	Glue guns Pistolety do klejenia		147
Water pump pliers Szcypce nastawne		134	Soldering tools & accessories Lutownice i akcesoria		147-148
Insulated flat nose pliers Klucze płaskie izolowane		134	Tweezers Pęsety		148
Insulated ring & open end wrenches Klucze oczkowe i płaskie izolowane		135	Insulated hexagonal sockets 3/8” Klucze nasadowe sześciokątne izolowane, krótkie 3/8”		136
Insulated ring wrenches Klucze oczkowe izolowane		135	Insulated extension bars 3/8” Przedłużki izolowane 3/8”		136
Insulated open end wrenches Klucze płaskie izolowane		135	Insulated ratchet handles 3/8” Grzechotki izolowane 3/8”		136
Insulated T-handle wrenches Rękojeści typu „T” z zabierakiem izolowane		135	Insulated hexagonal sockets 1/2” Klucze nasadowe sześciokątne izolowane, krótkie 1/2”		136
Insulated adjustable wrenches Klucze nastawne izolowane		135	Insulated extension bars 1/2” Przedłużki izolowane 1/2”		137
Insulated sockets & accessories Klucze nasadowe izolowane i akcesoria		136-137	Insulated ratchet handles 1/2” Grzechotki izolowane 1/2”		137
Insulated bit sockets 3/8”, 1/2” Klucze trzpieniowe izolowane 3/8”, 1/2”		137	Tool sets Zestawy narzędziowe		150
			Workshop standardized parts Normalia motoryzacyjne		151

GB Insulated screwdriver
D Isolierte Schraubendreher
PL Wkrętak izolowany
RUS Изолированная отвёртка

CZ Izolovaný šroubovák
H Szigetelt csavarhúzó
RO Şurubelniţă izolată
F Tournevis isolé

I Cacciavite isolato
E Destornillador aislado
CN 绝缘螺丝批

PLASTIC HANGER



1000 V S2
HRC 56-60 DVE



⊖ • application: industry • przeznaczenie: przemysł
• VDE certificate • certyfikat VDE

YATO	⊖	L (mm)	
YT-2815	3.0	75	12/120
YT-2816	4.0	75	12/120
YT-2817	4.0	100	12/120

YATO	⊖	L (mm)	
YT-2818	5.5	125	12/120
YT-2819	6.5	150	12/120
YT-2820	8.0	175	12/120

7



⊕ • application: industry • przeznaczenie: przemysł
• VDE certificate • certyfikat VDE

YATO	⊕	L (mm)	
YT-2821	PH0	60	12/120
YT-2822	PH1	80	12/120

YATO	⊕	L (mm)	
YT-2823	PH2	100	12/120
YT-2824	PH3	150	12/120



⊕ • application: industry • przeznaczenie: przemysł
• VDE certificate • certyfikat VDE

YATO	⊕	L (mm)	
YT-2825	PZ1	80	12/120

YATO	⊕	L (mm)	
YT-2826	PZ2	100	12/120

GB Insulated screwdriver set
D Isolierte Schraubendrehersatz
PL Komplet wkrętaków izolowanych
RUS Изолированная отвёртка - набор

CZ Izolované šroubováky
H Szigetelt csavarhúzó
RO Şurubelniţă izolată
F Set de tournevis isolés

I Set di cacciavite isolato
E Juego de destornilladores aislado
CN 绝缘螺丝批组套

DOUBLE BLISTER



1000 V S2
HRC 56-60 DVE



5 PCS ⊖ ⊕ • application: industry • przeznaczenie: przemysł
• VDE certificate • certyfikat VDE

YATO	⊖	⊕	L (mm)	
YT-2827	3.0		75	20/40
	4.0		100	
	5.5		125	
		PH1	80	
		PH2	100	

7 PCS ⊖ ⊕ ⊕ • application: industry • przeznaczenie: przemysł
• VDE certificate • certyfikat VDE

YATO	⊖	⊕	⊕	L (mm)	
YT-2828	3.0			75	20/40
	4.0			100	
	5.5			125	
		PH1		80	
		PH2		100	
			PZ1	80	
			PZ2	100	

GB Insulated changeable screwdriver set
D Schraubendreher Satz isoliert
PL Zestaw wkrętek z wymiennymi końcówkami izolowanymi

RUS Набор изолированных отверток
CZ Sada izolovaného nářadí
H Csavarhúzó kétfélgű szárral
RO Set surubelnita cu biti, izolate

F Jeu d'outils isolés
I Set di cacciavite isolato
E Juego de destornilladores aislado
CN 绝缘螺丝批组套

NYLON CASE



1000 V
HRC 54-61
S2





1000V
VDE CERTIFICATE
EN 60900:2012

12
PCS



 4x190 mm; 250V

YATO 	⊖	⊕	L (mm)		
YT-28290	2.0		100	4/48	
	2.5		100		
	3.0		100		
	3.5		100		
	4.0		100		
	5.5		100		
	6.5		100		
			PH0		100
			PH1		100
			PH2		100





1000V
VDE CERTIFICATE
EN 60900:2012

50
PCS



 4x190 mm; 250V

YATO 	⊖	⊕	⊕	⊗	⊙	⊠	⊡	⊢	⊣	⊤	⊥	L (mm)	
YT-28293	2.0											100	2/16
	2.5											100	
	3.0											100	
	3.5											100	
	4.0											100	
	5.5											100	
	6.5											100	
			PH0									100	
			PH1									100	
			PH2									100	
				PZ0								100	
				PZ1								100	
				PZ2								100	
					T6							100	
					T8							100	
					T9							100	
					T10							100	
					T15							100	
					T20							100	
					T25							100	
					T27							100	
					T30							100	
						2.0						100	
						3.0						100	
						4.0						100	
						5.0						100	
						6.0						100	
							R1					100	
							R2					100	
								1.0				100	
								2.0				100	
								3.0				100	
								4.0				100	
								4.0			100		
								6.0			100		
								8.0			100		
								10.0			100		
									4.0		100		
									6.0		100		
									8.0		100		
									10.0		100		
										M4	100		
										M5	100		
										M6	100		

GB Combination pliers
 D Kombinationszange
 PL Szczypce uniwersalne
 RUS Плоскогубцы универсальные
 CZ Kleště kombinované
 H Kombináltfogó
 RO Patent universal
 F Pince universelle
 I Pinze universali
 E Alicates universales
 CN 钢丝钳

160 mm 180 mm 200 mm CrV 1000 V



HALF DOUBLE BLISTER

YATO	L (mm)	
YT-21151	160	6/36
YT-21152	180	6/36
YT-21153	200	6/36

1000V
 VDE CERTIFICATE
 EN 60900:2012

GB Diagonal side cutting pliers
 D Seitenschneider
 PL Szczypce tnące boczne
 RUS Бокорезы
 CZ Řezací kleště boční
 H Oldal csípőfogó
 RO Olește tăietor
 F Pince à coupe latérale
 I Pinze taglianti laterali
 E Alicates corte lateral
 CN 斜嘴钳

160 mm 180 mm CrV 1000 V



HALF DOUBLE BLISTER

YATO	L (mm)	
YT-21158	160	6/36
YT-21159	180	6/36

1000V
 VDE CERTIFICATE
 EN 60900:2012

GB Long nose pliers
 D Radiozange
 PL Szczypce wydłużone proste
 RUS Тонкогубцы прямые
 CZ Prodloužené kleště rovné
 H Rádiófogó, egyenes
 RO Clește cu vârf ascuțit
 F Pince prolongée
 I Pinze lunghe diritte
 E Alicates de punta
 CN 尖嘴钳

160 mm 200 mm CrV 1000 V



HALF DOUBLE BLISTER

YATO	L (mm)	
YT-21154	160	6/36
YT-21155	200	6/36

1000V
 VDE CERTIFICATE
 EN 60900:2012

GB Wire stripping pliers
 D Abisolierzange
 PL Szczypce do ściągania izolacji
 RUS Пасатижи для зачистки проводов
 CZ Kleště odizolovací na drát
 H Blankoló fogó
 RO Decablator
 F Pince à l'isolation
 I Pinze spelafili
 E Pinzas pelacables
 CN 剥线钳

160 mm CrV 1000 V



HALF DOUBLE BLISTER

YATO	L (mm)	
YT-21160	160	6/36

1000V
 VDE CERTIFICATE
 EN 60900:2012

GB Water pump pliers
 D Wasserpumpenzange
 PL Szczypce nastawne
 RUS Клещи переставные
 CZ Keleště siko
 H Vízpumpafogó
 RO Clește papagal

F Pince réglable
 I Pinze regolabili
 E Alicates de fontanero ajustables
 CN 水泵钳

250 mm CrV 1000 V



HALF DOUBLE BLISTER

YATO	L (mm)	
YT-21161	250	6/24

1000V
 VDE CERTIFICATE
 EN 60900:2012

GB Insulated flat nose pliers
 D Sicherheitsklammer mit Haken
 PL Szczypce płaskie izolowane
 RUS Клещи для замены предохранителей
 CZ Izolované kleště s plochými čelistmi
 H Rugós szorító
 RO Patent izolat
 F Pince plate isolée
 I Pinze plate plastica isolati
 E Alicates punta plana aislantes
 CN 绝缘平嘴钳

200 mm CrV 1000 V



YATO	L (mm)	
YT-21191	200	6/48

1000V
 VDE CERTIFICATE
 EN 60900:2012

GB Insulated ring wrench
D Einringschlüssel vollisoliert
PL Klucz oczkowy odgięty izolowany
RUS Ключ накидной односторонний изолированный

CZ Očkový klíč, izolovaný
H Hajlítotszárú csillagkulcs
RO Cheie inelară izolată
F Clé polygonale coudée isolée

I Chiave poligonale piegato isolato
E Llave de estrella acodada aislante
CN 绝缘梅花扳手



1000V
VDE CERTIFICATE
EN 60900:2012

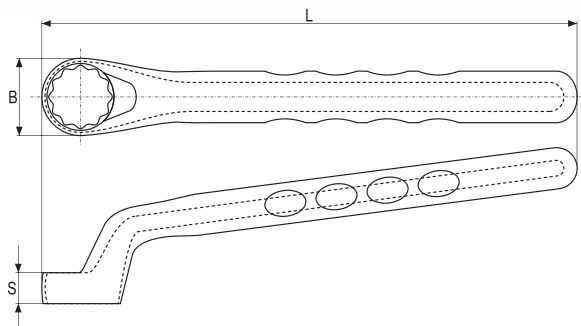
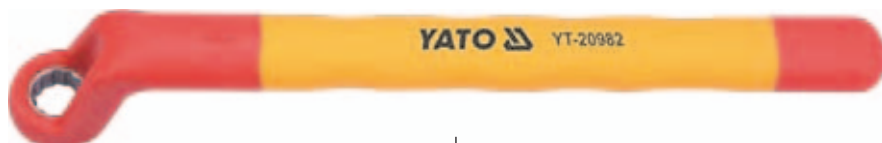

YATO	Ø (mm)	L (mm)	B (mm)	S (mm)	
YT-20980	6	150	16.0	5.5	6/126
YT-20981	7	150	18.0	5.7	6/126
YT-20982	8	155	19.0	6.1	6/126
YT-20983	9	155	20.0	7.2	6/126
YT-20984	10	170	21.0	7.3	6/90
YT-20985	11	170	22.5	7.7	6/90
YT-20986	12	190	22.5	8.5	6/90
YT-20987	13	190	26.5	9.0	6/90
YT-20988	14	205	28.0	9.5	6/90
YT-20989	15	205	29.0	9.5	6/90
YT-20990	16	215	31.0	10.2	6/90
YT-20991	17	215	32.0	10.7	6/90
YT-20992	18	230	35.0	11.5	6/90
YT-20993	19	230	36.0	12.0	6/90
YT-20994	21	245	39.0	13.0	6/48
YT-20995	22	245	41.0	12.2	6/48
YT-20996	24	265	44.0	13.0	6/48
YT-20997	27	290	48.0	14.5	4/40
YT-20998	30	310	52.0	15.2	4/40
YT-20999	32	310	55.0	16.5	4/40

GB Insulated open end wrench
D Doppelmautschlüssel isoliert
PL Klucz płaski izolowany
RUS Ключ рожковый односторонний изолированный

CZ Otevřený klíč, izolovaný
H Villáskulcs
RO Cheie fixă izolată
F Clé plate isolée

I Chiave piatta isolato
E Llave fija aislante
CN 绝缘开口扳手

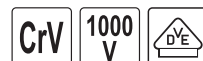

1000V
VDE CERTIFICATE
EN 60900:2012

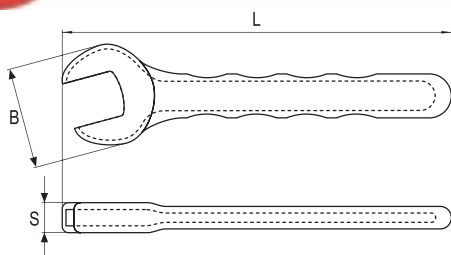

YATO	Ø (mm)	L (mm)	B (mm)	S (mm)	
YT-20950	6	90	23	7.0	6/108
YT-20951	7	90	25	7.0	6/108
YT-20952	8	100	27	7.5	6/108
YT-20953	9	100	29	7.5	6/108
YT-20954	10	110	31	8.0	6/108
YT-20955	11	110	34	8.5	6/108
YT-20956	12	130	36	8.5	6/108
YT-20957	13	135	39	10.5	6/108
YT-20958	14	145	40	10.5	6/72
YT-20959	15	150	42	11.5	6/72
YT-20960	16	160	43	11.5	6/72
YT-20961	17	160	47	12.5	6/72
YT-20962	18	175	50	13.0	6/72
YT-20963	19	175	53	14.0	6/72
YT-20964	21	195	55	14.0	6/66
YT-20965	22	195	58	14.0	6/66
YT-20966	24	225	62	16.5	6/66
YT-20967	27	250	69	18.0	4/60
YT-20968	30	290	75	19.0	4/48
YT-20969	32	310	79	20.0	4/48

GB Insulated T-handle wrench
D Steckschlüssel T-griff vollisoliert
PL Rękojeść typu „T” izolowana
RUS Ручка Т-образная изолированная
CZ Klíč nástrčný typ „T”, izolovaný

H „T” típusú dugókulcs
RO Manerit tip „T” izolat
F Clé à tube en „T” isolée
I Chiave a bussola tipo „T” isolati
E Llave tubular „T” aislante
CN 绝缘T型扳手

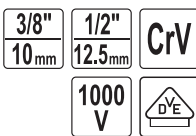

GB Insulated adjustable wrench
D Rollgabelschlüssel isoliert
PL Klucz nastawny izolowany
RUS Ключ разводной изолированный
CZ Izolovaný staviteľný klíč
H Allítható svédkulcs
RO Cheie reglabilă izolată
F Clé à molette isolée
I Isolati chiave regolabile
E Llave ajustable aislante
CN 绝缘活络扳手

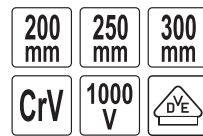

1000V
VDE CERTIFICATE
EN 60900:2012



YATO	L (mm)	
YT-20940	200	6/48
YT-20941	250	6/36
YT-20942	300	4/24

1000V
VDE CERTIFICATE
EN 60900:2012

YATO	Ø H	L1 (mm)	L2 (mm)	Ø (mm)	
YT-21095	3/8" (9.5 mm)	207	160	15.6	4/32
YT-21096	1/2" (12.7 mm)	207	160	19.3	4/32

- GB Insulated hexagonal socket
- D Sechskantenschlüssel vollisoliert
- PL Nasadka sześciokątna izolowana
- RUS Головка шестигранная короткая изолированная
- CZ Šestihranný nástavec, izolovaný
- H Hatszögű rátét
- RO Cheie tubulară hexagonală izolată
- F Douille courte isolée
- I Chiave a bussola esagonale isolato
- E Boquilla hexagonal corta aislante
- CN 绝缘六角套筒

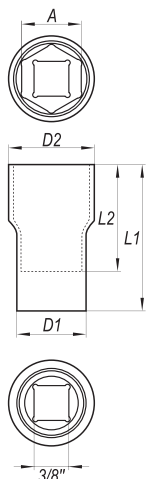

3/8" 10mm CrV 1000 V DYE

1000V VDE CERTIFICATE EN 60900:2012

YATO	∅ A (mm)	D1 (mm)	D2 (mm)	L1 (mm)	L2 (mm)	
YT-21008	8	18	15.1	45	28	7/126
YT-21010	10	18	18.7	45	28	7/126
YT-21011	11	18	20.0	45	28	7/126
YT-21012	12	18	21.2	45	28	7/126
YT-21013	13	18	22.5	45	28	7/126
YT-21014	14	18	23.7	45	28	7/126
YT-21016	16	18	26.2	45	28	7/126
YT-21017	17	18	27.5	45	28	7/126
YT-21018	18	18	28.7	45	30	5/90
YT-21019	19	18	30.0	47	30	5/90
YT-21021	21	18	32.6	47	30	5/90
YT-21022	22	18	33.7	47	30	5/90

7

- GB Insulated extension bar
- D Verlängerung vollisoliert
- PL Przedłużka izolowana
- RUS Удлинитель для воротка
- CZ Prodlužovací příravek, izolovaný
- H Toldalek
- RO Prelungitor izolat
- F Rallonge isolée
- I Prolunga isolato
- E Tubo de prolongación aislante
- CN 绝缘接杆

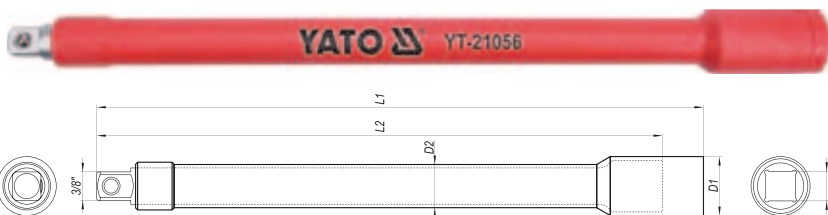

3/8" 10mm CrV 1000 V DYE

1000V VDE CERTIFICATE EN 60900:2012

YATO	∅	D1 (mm)	D2 (mm)	L1 (mm)	L2 (mm)	
YT-21055	3/8" (9.5 mm)	23	15.5	125	141	18/72
YT-21056	3/8" (9.5 mm)	23	15.5	250	266	12/48

- GB Insulated ratchet handle
- D Hebelumschaltknarre vollisoliert
- PL Grzechotka izolowana
- RUS Трещотка диэлектрическая
- CZ Rehtačka, izolovaná
- H Racsnis hajtókar
- RO Antrenor cu clichet izolat
- F Clé à cliquet isolée
- I Cricchetto bussola isolato
- E Carraca aislante
- CN 绝缘棘轮扳手



3/8" 10mm CrV 1000 V DYE

YATO	∅	T	L (mm)	
YT-21071	3/8" (9.5 mm)	36	200	6/48

- GB Insulated hexagonal socket
- D Sechskantenschlüssel vollisoliert
- PL Nasadka sześciokątna izolowana
- RUS Головка шестигранная короткая изолированная
- CZ Šestihranný nástavec, izolovaný
- H Hatszögű rátét
- RO Cheie tubulară hexagonală izolată
- F Douille courte isolée
- I Chiave a bussola esagonale isolato
- E Boquilla hexagonal corta aislante
- CN 绝缘六角套筒

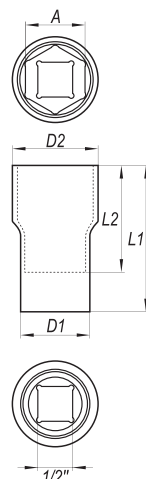

1/2" 12.5mm CrV 1000 V DYE

1000V VDE CERTIFICATE EN 60900:2012

YATO	∅ A (mm)	D1 (mm)	D2 (mm)	L1 (mm)	L2 (mm)	
YT-21030	10	27	19.5	55	38	12/144
YT-21031	11	27	20.7	55	38	12/144
YT-21032	12	27	22.0	55	38	12/144
YT-21033	13	27	23.2	55	38	12/144
YT-21034	14	27	24.5	55	38	12/144
YT-21036	16	27	27.0	55	38	12/144
YT-21037	17	27	28.5	55	38	12/144
YT-21038	18	27	29.5	55	38	12/144
YT-21039	19	27	30.7	55	38	12/144
YT-21041	21	27	33.2	55	38	10/110
YT-21042	22	27	34.5	55	38	10/110
YT-21044	24	27	37.0	60	38	10/110
YT-21047	27	27	38.8	60	38	6/66
YT-21050	30	27	42.8	60	38	6/66
YT-21052	32	27	44.8	60	38	6/66

- GB Insulated extension bar
D Verlängerung vollisoliert
PL Przedłużka izolowana
RUS Удлинитель для воротка
CZ Prodlužovací přípravek, izolovaný
H Toldalék
RO Prelungitor izolat
F Rallonge isolée
I Prolunga isolato
E Tubo de prolongación aislante
CN 绝缘接杆

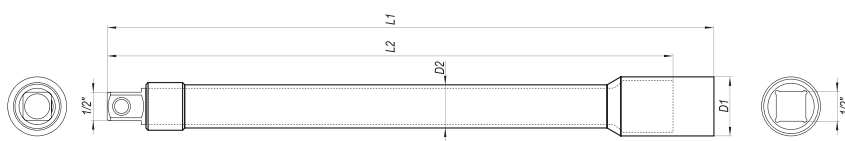
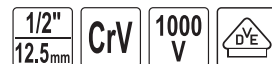

1000V VDE CERTIFICATE EN 60900:2012

YATO	Ø	D1 (mm)	D2 (mm)	L1 (mm)	L2 (mm)	
YT-21057	1/2" (12.7 mm)	27	19.1	125	141	6/72
YT-21058	1/2" (12.7 mm)	27	19.1	250	266	8/32

- GB Insulated ratchet handle
D Hebelumschaltknarre vollisoliert
PL Grzechotka izolowana
RUS Трещотка диэлектрическая
CZ Řehťačka, izolovaná
H Racsnis hajtókar
RO Antrenor cu clichet izolat
F Clé à cliquet isolée
I Cricchetto bussola isolato
E Carraca aislante
CN 绝缘棘轮扳手

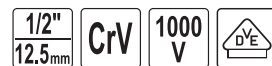

1000V VDE CERTIFICATE EN 60900:2012

YATO	Ø	T	L (mm)	
YT-21072	1/2" (12.7 mm)	36	250	6/36

- GB Insulated star bit socket
D Aufsteckschlüssel vollisoliert
PL Klucze trzpieniowe izolowane
RUS Головка торцевая с вставкой hex изолированная
CZ Čepové klíče izolované

- H Csapkulcs
RO Chei cu cozi izolat
F Douille tournevis isolée
I Chiave esagonale isolato
E Llaves de mandril aislante
CN 绝缘套筒批

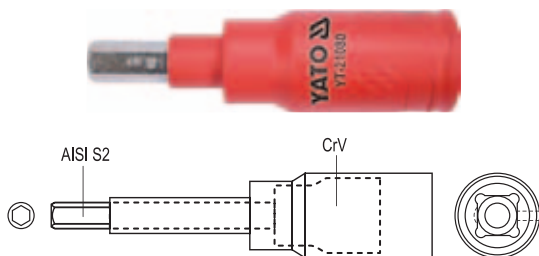

3/8"
10mm

1000V VDE CERTIFICATE EN 60900:2012

YATO	Ø	Hex	L (mm)	torque / moment obrotowy max. (Nm)	
YT-21080	3/8" (9.5 mm)	4	75	16.0	12/144
YT-21081	3/8" (9.5 mm)	5	75	30.0	12/144
YT-21082	3/8" (9.5 mm)	6	75	52.0	12/144
YT-21083	3/8" (9.5 mm)	8	75	120.0	12/144

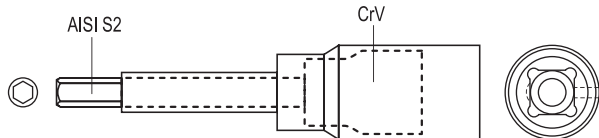

1/2"
12.5mm

1000V VDE CERTIFICATE EN 60900:2012

YATO	Ø	Hex	L (mm)	torque / moment obrotowy max. (Nm)	
YT-21085	1/2" (12.7 mm)	4	120	16.0	18/144
YT-21086	1/2" (12.7 mm)	5	120	30.0	18/144
YT-21087	1/2" (12.7 mm)	6	120	52.0	18/144
YT-21088	1/2" (12.7 mm)	8	120	120.0	18/144
YT-21089	1/2" (12.7 mm)	10	120	220.0	18/144

- GB Insulated hex key
D Steckschlüssel
PL Klucz sześciokątny izolowany
RUS Накладной гаечный ключ угловой
CZ Imbusové klíče izolované
H Imbisz kulcs

- RO Imbusuri hexagonale izolate
F Clés allen isolée
I Chiave esagonale isolato
E Punta vaso aislante
CN 绝缘内六角扳手

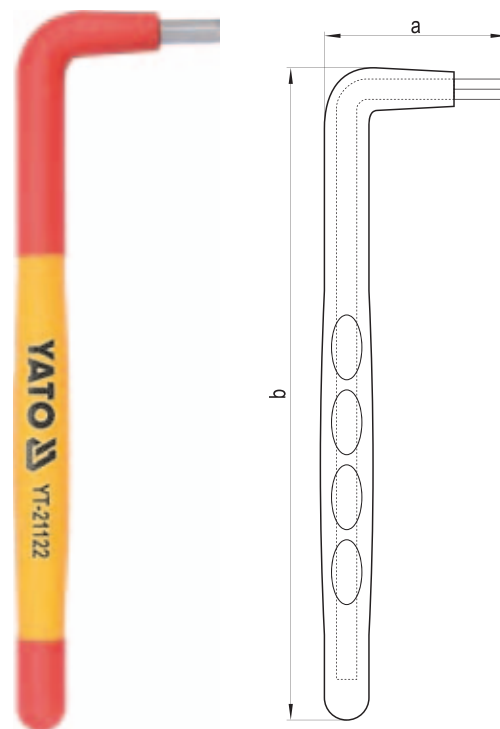

1000V VDE CERTIFICATE EN 60900:2012

YATO	Ø (mm)	a (mm)	b (mm)	
YT-21120	3.0	25	130	12/144
YT-21121	4.0	40	140	12/144
YT-21122	5.0	45	160	12/144
YT-21123	6.0	47	180	10/120
YT-21125	8.0	50	200	10/120
YT-21126	10.0	52	235	6/48
YT-21127	12.0	60	260	6/48

- GB Insulated spring clamp
- D Federklemme vollisoliert
- PL Ścisk sprężynowy izolowany
- RUS Струбцина изолированная
- CZ Pružinové upínadlo izolované
- H Rugós szorító
- RO Clește presa pt. lemn izolat
- F Pince de serrage isolée
- I Pinze di bloccaggio isolate
- E Pinza aislante
- CN 弹簧夹



150 mm CrV 1000 V DYE

YATO	working capacity / zakres pracy (mm)	L (mm)	
YT-21190	2-20	150	5/40

- GB Quick interchangeable ratchet crimper set
- D Kabelschuhzange
- PL Zestaw do zaciskania konektorów
- RUS Инструмент для обжима и зачистки проводов
- CZ Kleště pro svěrání zaciskania konektorů
- H Krimpelő fogó
- RO Clește sertizat conectori
- F Pince à sertir pour connecteurs
- I Set pinze i compare a connettori
- E Pinzas de apretar de conectores
- CN 棘轮压线钳组套



6 PCS

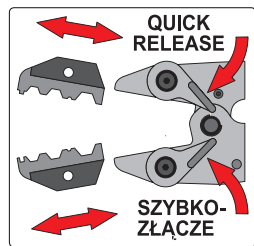

BMC & COLOR SLEEVE

YATO	[Icon]		[Icon]		[Icon]		[Icon]		[Icon]	[Icon]
	mm ²	AWG	mm ²	AWG	mm ²	AWG	mm ²	AWG		
YT-2245	0.5-6.0	20-10	0.5-6.0	22-10	1.5-10.0	20-8	0.5-4.0	22-12	RG6, RG58, RG59, RG62	10

- GB Ratchet crimping pliers
- D Kabelschuhzange
- PL Szczypce do zaciskania konektorów
- RUS Инструмент для обжима и зачистки проводов

- CZ Kleště pro svěrání zaciskania konektorů
- H Krimpelő fogó
- RO Clește sertizat conectori
- F Pince pour serrer les connecteurs

- I Pinze i compare a connettori
- E Pinzas de apretar de conectores
- CN 棘轮压线钳

SLIDING CARD



YATO	mm ²	AWG	
YT-2250	0.5-6.0	20-10	5/30

YATO	mm ²	AWG	
YT-2300	0.5-6.0	20-10	5/30

- GB Ratchet crimping pliers
- D Kabelschuhzange
- PL Szczypce do zaciskania konektorów
- RUS Инструмент для обжима и зачистки проводов

- CZ Kleště pro svěrání zaciskania konektorů
- H Krimpelő fogó
- RO Clește sertizat conectori
- F Pince pour serrer les connecteurs

- I Pinze i compare a connettori
- E Pinzas de apretar de conectores
- CN 棘轮压线钳

BLISTER CARD



YATO	[Icon]		[Icon]		[Icon]
	mm ²	AWG	mm ²	AWG	
YT-2255	0.08-2.0	28-14	0.12-0.3	26-22	10/60

YATO	[Icon]		[Icon]		[Icon]		[Icon]
	mm ²	AWG	mm ²	AWG	mm ²	AWG	
YT-2256	0.08-2.0	28-14	0.3-6.0	22-10	0.12-0.3	26-22	10/60

GB Ratchet crimping pliers
D Kabelschuhzange
PL Szczypce do zaciskania konektorów
RUS Инструмент для обжима
и зачистки проводов

CZ Kleště pro svěrání zaciskání konektorů
H Krimpelő fogó
RO Clește sertizat conectori
F Pince pour serrer les connecteurs

I Pinze i compare a connettori
E Pinzas de apretar de conectors
CN 棘轮压线钳

SLIDING
CARD



YATO	mm ²	AWG	
YT-2296	0.5-6.0	22-10	5/30



YATO	mm ²	AWG	
YT-2246	0.5-6.0	22-10	5/30



YATO	mm ²	AWG	
YT-2251	0.5-6.0	22-10	5/30



YATO	mm ²	AWG	
YT-2302	0.5-6.0	22-10	5/30



YATO	mm ²	AWG	
YT-2307	0.5-2.5	22-14	6/36



YATO			
YT-2298	RG6, RG58, RG59, RG62		5/30



YATO	mm ²	AWG	
YT-2247	1.5-10.0	20-8	5/30



YATO	mm ²	AWG	
YT-2297	1.5-10.0	20-8	5/30



YATO	mm ²	AWG	
YT-2299	0.5-4.0	22-12	5/30



YATO	mm ²	AWG	
YT-2249	0.5-4.0	22-12	5/30

GB Ratchet crimping pliers
 D Kabelschuhzange
 PL Szczypce do zaciskania konektorów
 RUS Инструмент для обжима
 и зачистки проводов

CZ Kleště pro svěráni zaciskania konektorů
 H Krimpelő fogó
 RO Clește sertizat conectori
 F Pince pour serrer les connecteurs

I Pinze i compare a connettori
 E Pinzas de apretar de conectores
 CN 棘轮压线钳

SLIDING
CARD

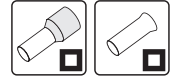

HRC
44-47



YATO 	 mm²	
YT-2240	0.2-6.0	6/36

YATO 	 mm²	
YT-2305	0.2-6.0	6/36

7

GB Crimping pliers
 D Kabelschuhzange
 PL Szczypce do zaciskania konektorów
 RUS Инструмент для обжима
 и зачистки проводов
 CZ Kleště pro svěráni zaciskania konektorů

H Krimpelő fogó
 RO Clește sertizat conectori
 F Pince pour serrer les connecteurs
 I Pinze i compare a connettori
 E Pinzas de apretar de conectores
 CN 棘轮压线钳

SLIDING
CARD



YATO 		
YT-2242	RJ45	10/60



SK5

YATO 		
YT-2243	RJ45, RJ11	8/48



SK5

YATO 		
YT-22422	RJ45, RJ11, RJ12	10/60



SK5



YATO 		
YT-2244	RJ45, RJ11, RJ12, RJ22	10/60

- GB Hydraulic pliers
- D Manuelle Hydraulikpresse
- PL Ręczna praska hydrauliczna
- RUS Ручной гидравлический обжимной инструмент
- CZ Ruční hydraulický lis
- H Kézi hidraulikus prés
- RO Presă hidraulică manuală
- F Pince à sertir
- I Pressa idraulica manuale
- E Prensa hidráulica manual
- CN 液压钳



BMC & COLOR SLEEVE







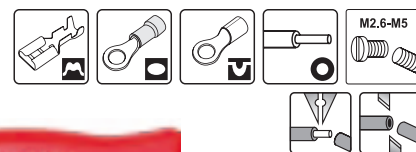

YATO 	crimping size range / zakres zaciskania (mm²)		L (mm)	pressure / nacisk (T)	crimping jaws size / rozmiar szczęk zaciskających (mm²)	
	aluminium	copper / miedź				
YT-22860	10-95	10-120	415	8	10; 16; 25; 35; 50; 70; 95; 120	4
YT-22861	16-185	16-240	470	12	16; 25; 35; 50; 70; 95; 120; 150; 185; 240	3
YT-22862	16-240	16-300	470	18-20	16; 25; 35; 50; 70; 95; 120; 150; 185; 240; 300	3

7

- GB Crimping pliers
- D Kabelschuhzange
- PL Szczypce do zaciskania konektorów
- RUS Инструмент для обжима и зачистки проводов
- CZ Kleště pro svěření zaciskania konektorů
- H Krimpelő fogó
- RO Clește sertizat conectori
- F Pince pour serrer les connecteurs
- I Pinze i compare a connettori
- E Pinzas de apretar de conectores
- CN 棘轮压线钳



SLIDING CARD

YATO 									
	mm²	AWG	mm²	AWG	mm²	AWG	mm²	AWG	
YT-2254	0.5-5.0	20-10	0.5-5.0	20-10	0.5-5.5	20-10	0.5-5.0	20-10	12/48

- GB Wire stripper
- D Abisolierzange
- PL Ściągacz izolacji
- RUS Съёмник изоляции
- CZ Odizolovací klejte
- H Blankolo fogo

- RO Decablator
- F Extracteur d'isolation
- I Pinze per scaricare isolamento



- E Extractor de aislado
- CN 万用剥线钳

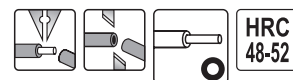

SLIDING CARD



HRC 48-52



YATO 			
	mm²	AWG	
YT-2266	0.25-1.3	30-16	10/60



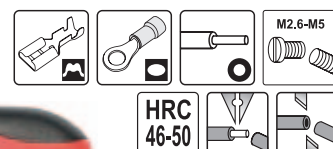

YATO 			
	mm²	AWG	
YT-2267	0.8-2.6	20-10	10/60

- GB Wire stripper
- D Abisolierzange
- PL Ściągacz izolacji
- RUS Съёмник изоляции
- CZ Odizolovací klejte
- H Blankolo fogo
- RO Decablator
- F Extracteur d'isolation
- I Pinze per scaricare isolamento
- E Extractor de aislado
- CN 万用剥线钳



HRC 46-50

SLIDING CARD

YATO 							
	mm²	AWG	mm²	AWG	mm²	AWG	
YT-22930	1.5-6.0	22-10	1.5-6.0	22-10	0.75-6.0	22-10	12/48

GB Wire stripper
 D Abisolierzange
 PL Ściągacz izolacji
 RUS Съёмник изоляции
 CZ Odizolovací klejte

H Blankolo fogo
 RO Decablator
 F Extracteur d'isolation

I Pinze per scaricare isolamento
 E Extractor de aislado
 CN 万用剥线钳



YATO	mm ²	AWG	mm ²	AWG	PCS packing	Box
YT-2293	1.25-2.5	8-12	1.0	8	12	72

7



YATO	mm ²	AWG	mm ²	AWG	Box
YT-2294	0.64-2.6	22-10			12/120

GB Universal wire stripper & ratchet crimping pliers
 D Multifunktion Abisolierzange & Kabelschuhklemmzange
 PL Uniwersalny ściągacz izolacji i szczypce do zaciskania konektorów

RUS Инструмент для снятия изоляции и зажима проводов
 CZ Univerzální odizolovací klejte & kleště pro svěření zaciskania konektorů
 H Blankolo fogo & krimpelő fogó
 RO Decablator universal & clește sertizat conectori

F Extracteur d'isolation multifonction
 I Pinze per scaricare isolamento
 E Extractor de aislado multifunción
 CN 万用剥线钳

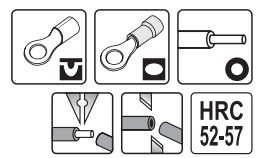

YATO	mm ²	AWG	mm ²	AWG	mm ²	AWG	Box
YT-2270	0.5-6.0	22-10	1.5-6.0	22-10	0.2-6.0	24-10	5/30

- GB Universal wire stripper & ratchet crimping pliers
D Multifunktion Abisolierzange & Kabelschuhklemmzange
PL Uniwersalny ściągacz izolacji i szczytce do zaciskania konektorów
RUS Инструмент для снятия изоляции и зажима проводов
CZ Univerzální odizolovací klejště & Kleště pro svěrání zaciskání konektorů
H Blankolo fogo & krimpelő fogó
RO Decablator universal & clește sertizat conectori
F Extracteur d'isolation multifonction
I Pinze per scaricare isolamento
E Extractor de aislado multifunción
CN 剥线钳



SLIDING CARD

YATO	□		○		📦
	mm ²	AWG	mm ²	AWG	
YT-2278	0.5-6.0	22-10	0.2-6.0	24-10	10/60

- GB Automatic wire stripper
D Automatische Abisolierzange
PL Automacyjny ściągacz izolacji
RUS Клещи для удаления изоляции
CZ Automatický stahovač izolace
H Automatikus szigeteléslehúzó
RO Clește automat pt. desizolat

- F Extracteur d'isolation automatique
I Pinze per scaricare isolamento
E Pelacables automatico
CN 万用剥线钳

SLIDING CARD

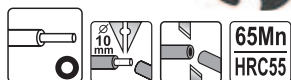

65Mn
HRC55

YATO	○		📦
YT-2268	mm ²	AWG	
YT-2268	0.5-6.0	20-10	10/60

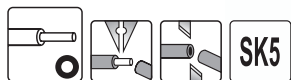

SK5

YATO	○		📦
YT-2275	mm ²	AWG	
YT-2275	0.5-6.0	20-10	10/60



SK5

YATO	○		📦
YT-2276	mm ²	AWG	
YT-2276	1.0-3.2	18-12	8/48



SK5

YATO	○		📦
YT-2316	mm ²	AWG	
YT-2316	1.0-3.2	18-12	8/48

- GB Wire stripper
D Abisolierzange
PL Ściągacz izolacji
RUS Съёмник изоляции
CZ Odizolovací klejště
H Blankolo fogo

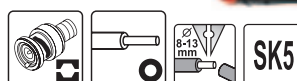

SK5

SLIDING CARD

YATO	○		📦
YT-2274	mm ²	AWG	
YT-2274	RG9, RG59	0.5-6.0	20-10

- GB Electrical cutter
D Seitenschneider
PL Obcinak elektryczny
RUS Инструмент для обрезки проводов
CZ Elektrické upichovky
H Kábelvágó
RO Clește tăietor - electrician
F Coupeur isolé

- I Pinza per elettronica
E Cortacables eléctricos
CN 电子斜嘴钳



125 mm

SLIDING CARD

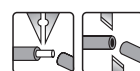

YATO	○		L (mm)	📦
YT-2260	mm ²	AWG		
YT-2260	0.5-1.5	20-18	125	15/150



YATO	○		L (mm)	📦
YT-2261	mm ²	AWG		
YT-2261	0.5-1.5	20-18	125	15/150

- GB Electrical cutter
D Seitenschneider
PL Obcinak elektryczny
RUS Инструмент для обрезки проводов
CZ Elektrické upichovky
H Kábelvágó
RO Clește tăietor - electrician
F Coupeur isolé

- I Pinza per elettronica
E Cortacables eléctricos
CN 电子斜嘴钳



125 mm



3.0 mm (max)
STAINLESS STEEL
NERDZEWA

SLIDING CARD



YATO	○		L (mm)	📦
YT-2262	mm ²	AWG		
YT-2262	0.5-1.5	20-18	125	20/120

GB Electrical cutter
D Seitenschneider
PL Obcinak elektryczny
RUS Инструмент для обрезки проводов
CZ Elektrické upichováký
H Kábelvágó
RO Clește tăietor - electrician

F Coupeur isolé
I Pinza per elettronica
E Cortacables eléctricos
CN 电子斜嘴钳

130 mm
HRC 55-57
65 Mn



SLIDING CARD

YATO	mm ²	AWG	L (mm)	
YT-2263	0.5-1.5	20-18	130	12/120

GB Cable cutter
D Kabelschere
PL Szczypce do cięcia przewodów
RUS Кабелерезы
CZ Elektrické upichováký
H Kábelvágó

RO Patent tăietor pt. electrice
F Pince pour câbles
I Cesoia per cavi elettrici
E Tijeras para cables
CN 电缆断线钳

170 mm
3.5 mm
10.5 (max)
SK5



SLIDING CARD

YATO	max. Ø (mm)	L (mm)	
YT-2279	10.5	170	10/60

GB Cable stripper
D Kabelmesser
PL Nożyk do kabli
RUS Нож кабельный
CZ Nůž na kabele
H Kábelkés

RO Cuțitaș pt. cabluri
F Couteau aux câbles
I Coltellino per cavi
E Cuchillo
CN 电缆剥线钳



SLIDING CARD

YATO Ø (mm)

YT-2280	8-28	10/100
---------	------	--------

GB Insulated electrician scissors
D Elektrische Schere
PL Nożycki dla elektryków izolowane
RUS Ножницы диэлектрические универсальные
CZ Elektrické nůžky
H Univerzális olló

RO Foarfece - electrician izolat
F Ciseaux pour electriciens
I Forbici per elettricisti
E Tijeras eléctricos
CN 绝缘电工剪

160 mm
CrV
1000 V





1000V VDE CERTIFICATE EN 60900:2012

YATO	L (mm)	
YT-21200	160	6/48

GB Electrician scissors
D Elektrische Schere
PL Nożycki dla elektryków
RUS Ножницы универсальные
CZ Elektrické nůžky
H Univerzális olló
RO Foarfece - electrician

F Ciseaux pour electriciens
I Forbici per elettricisti
E Tijeras eléctricos
CN 电工剪

140 mm
STAINLESS STEEL STAL NERDZEWA
HRC 52-56



SLIDING CARD

YATO	L (mm)	
YT-1974	140	12/120

GB Insulated cable knife
D Kabelmesser gerade
PL Nóż dla elektryków izolowany
RUS Нож кабельный изолированный
CZ Izolovaný nůž
H Szerelőkés

RO Cutit pt. cabluri izolat
F Couteau d'électricien
I Coltello per elettricisti isolato
E Cuchillo electricista aislante
CN 绝缘电工刀

180 mm
50 mm
65 Mn
1000 V



1000V VDE CERTIFICATE EN 60900:2012

YATO	L (mm)	
YT-21210	180	6/72

GB Insulated dismantling knife
D Abmantelungsmesser
PL Nóż demontażowy dla elektryków
RUS Нож кабельный изолированный
CZ Zahnutý nůž s vodítkem, izolovaný

H Szerelőkés
RO Cutit demontabil izolat
F Couteau d'électricien
I Coltello di smontaggio per elettricisti isolati
E Cuchillo de desmontaje aislante
CN 绝缘电工刀

155 mm
38 mm
65 Mn
1000 V



1000V VDE CERTIFICATE EN 60900:2012

YATO	L (mm)	
YT-21211	155	6/72

GB Electrician's knife
D Montagmesser
PL Nóż składany monterski
RUS Нож складной

CZ Montážní nůž
H Szerelőkés
RO Cuțit pt. decablant
F Couteau d'électricien

I Coltello
E Cuchillo de montaje
CN 电工刀

85 mm
200 mm



SLIDING CARD

YATO	L (mm)	
YT-7600	200	6/96

GB Electrician's knife
D Montagmesser
PL Nóż składany monterski
RUS Нож складной

CZ Montážní nůž
H Szerelőkés
RO Cuțit pt. decablant
F Couteau d'électricien

I Coltello
E Cuchillo de montaje
CN 电工刀

75 mm
190 mm



SLIDING CARD

YATO	L (mm)	
YT-7601	190	6/96

- GB Cable cutter
D Kabelschere
PL Szczypce do cięcia przewodów
RUS Кабелерезы
CZ Elektrické upichováky
H Kábelvágó
RO Patent tăietor pt. electrice
F Pince à couper les fils
I Pinze per tagliare i cavi
E Tijeras para cables
CN 电缆剪

SLIDING CARD



- application: for copper and aluminium electric cables
- przeznaczenie: do cięcia miedzianych i aluminiowych kabli

YATO	L (mm)	max. Ø (mm)	
YT-1966	160	6	6/60
YT-1967	210	7	6/60
YT-1968	240	8	6/48

- GB Heavy duty cable cutter
D Schwere Drahtschere
PL Wzmocnione nożyce do cięcia przewodów
RUS Кабелерезы
CZ Elektrické upichováky
H Kábelvágó
RO Patent tăietor pt. electrice
F Pince renforcée à couper les fils
I Pinze per tagliare i cavi
E Tijeras para cables
CN 电缆剪

SLIDING CARD



- application: for copper and aluminium electric cables
- przeznaczenie: do cięcia miedzianych i aluminiowych kabli

YATO	L (mm)	max. Ø (mm)	
YT-1969	240	9	6/48

- GB Heavy duty cable cutter
D Schwere Drahtschere
PL Wzmocnione nożyce do cięcia przewodów
RUS Кабелерезы
CZ Elektrické upichováky
H Kábelvágó
RO Patent tăietor pt. electrice
F Pince renforcée à couper les fils
I Pinze per tagliare i cavi
E Tijeras para cables
CN 电缆剪

SLIDING CARD

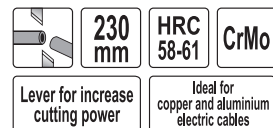

YATO	L (mm)	max. Ø (mm)	
YT-1933	230	9	6/36

- GB Cable cutter
D Kabelschere
PL Nożyce do kabli
RUS Кабелерезы
CZ Elektrické upichováky
H Kábelvágó
RO Patent tăietor pt. electrice
F Cisailles à câbles
I Cesoie per cavi
E Tijeras para cables
CN 电缆剪



COLOR BOX



STEEL
STAL

- GB Insulated cable cutter
D Kabelschere
PL Szczypce do cięcia przewodów izolowane
RUS Кабелерезы
CZ Elektrické upichováky, izolované
H Kábelvágó

- RO Cleste taiat cabluri izolat
F Pince renforcée isolée
I Pinze per tagliare i cavi isolati
E Tijeras para cables aislantes
CN 绝缘电缆剪

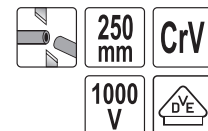

1000V VDE CERTIFICATE EN 60900:2012

YATO	L (mm)	max. Ø (mm)	
YT-21141	250	80	6/36

- GB Ratchet cable cutter
D Ratschenkabelschneider
PL Nożyce zapadkowe do kabli
RUS Кабелерез секторный
CZ Kleště na kabely, rohatka se západkou
H Racsnis kábelvágó
RO Cleste pt. taiat cablu cu clichet
F Cisailles à câbles
I Cricchetto taglia cavo
E Cortacables de carraca
CN 棘轮电缆剪

COLOR BOX



Cu/Al
CABLE
KABEL

60Si2Mn

HRC 50
CUTTING BLADE
OSTRZE THACE

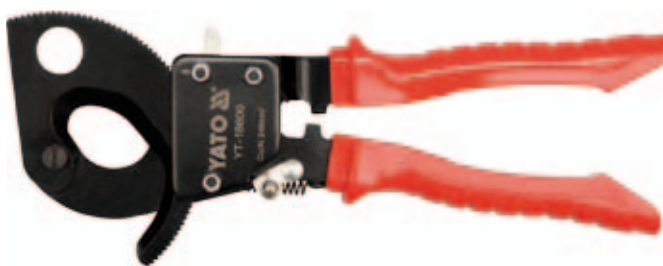

YATO	cutting range / max. przekrój cięcia (mm ²)	max. Ø (mm)	L (mm)	
YT-18600	240	17.5	300	10



YATO	cutting range / max. przekrój cięcia (mm ²)	max. Ø (mm)	L (mm)	
YT-18602	380	22	380	10

YATO	cutting range / max. przekrój cięcia (mm ²)	max. Ø (mm)	L (mm)	
YT-18610	125	12.5	370	20
YT-18611	250	18.0	580	10
YT-18612	500	25.0	770	5

GB Digital voltage tester
D Spannungsprüfer
PL Próbnik napięcia
RUS Отвёртка с передачей
CZ Zkoušeč napětí

H Fáziskereső
RO Creion de tensiune
F Testeur de tension type tournevis

I Cerca fase
E Comprobador de corriente
CN 多功能测电笔

PLASTIC HANGER



190 mm

125-250 V~



In accordance with polish standard PN-E 08509:1988
Zgodny z polską normą PN-E 08509:1988

YATO	⊖	L (mm)	
YT-28300	3.0	190	12/144

GB Digital voltage tester
D Spannungsprüfer
PL Próbnik napięcia
RUS Отвёртка с передачей
CZ Zkoušeč napětí

H Fáziskereső
RO Creion de tensiune
F Testeur de tension type tournevis

I Cerca fase
E Comprobador de corriente
CN 多功能测电笔

SLIDING CARD



1.5-9 V

50-500 Hz

CONTINUITY TEST TEST CIĄGŁOŚCI

70-250 V

70-600 V

POWER ZASILANE 2x1.5 V LR44 BATERIA* BATERIA* BATTERY NOT INCLUDED *BATERIA NIE DOŁĄCZONO

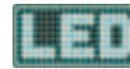

YATO			
YT-2864			6/120

7

GB Digital voltage tester
D Spannungsprüfer
PL Uniwersalny tester elektryczny
RUS Отвёртка с передачей

CZ Zkoušeč napětí
H Fáziskereső
RO Creion de tensiune
F Testeur de tension type tournevis

I Cerca fase digitale
E Comprobador de corriente
CN 测电笔

SLIDING CARD



1.5-9 V

50-500 Hz

70-250 V

70-1000 V

POWER ZASILANE 2x1.5 V LR44 BATERIA* BATERIA* BATTERY NOT INCLUDED *BATERIA NIE DOŁĄCZONO



YATO			
YT-28631			6/120

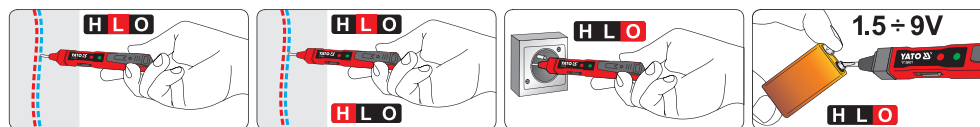

GB Digital voltage tester
D Digitaler-Spannungsprüfer
PL Wskaźnik elektryczny
RUS Тестер напряжения цифровой
CZ Zkoušečka napětí digitální
H Digitális voltmérő
RO Tester digital pt. tensiune electrica
F Testeur de tension type tournevis
I Cerca fase digitale
E Indicador eléctrico
CN 数显测电笔

SLIDING CARD



12-250 V

50-500 Hz

CONTINUITY TEST TEST CIĄGŁOŚCI

LCD DISPLAY

NO BATTERY NEEDED NEPOWOLNO BATERII



YATO			
YT-2861			20/500



YATO			
YT-2862			20/500



YATO			
YT-2863			6/120

GB Stud finder
D Entfernungsmesser
PL Wykrywacz profili i przewodów
RUS Цифровой детектор
CZ Digitální detektor
H Digitális kereső műszer
RO Detector digital
F Détecteur de métaux et de câbles électriques
I Detector digitale
E Escáner de pared
CN 墙体探测仪

HANGING COLOR BOX

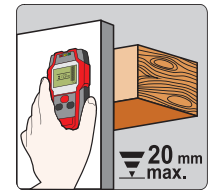
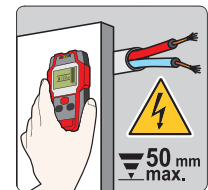
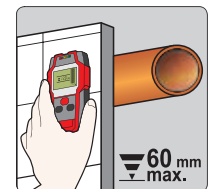
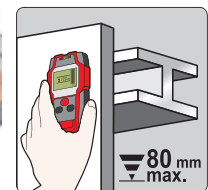

YATO			
YT-73131			40

GB Digital universal multimeter
D Universell digital Messgerät
PL Cyfrowy miernik uniwersalny
RUS Универсальный цифровой измеритель
CZ Digitální multimetr univerzální
H Digitális multiméter
RO Multimetru digital universal
F Multimètre numérique
I Universale tester digitale
E Manómetro digital universal
CN 数字万用表

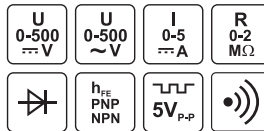

YATO
YT-73080 50

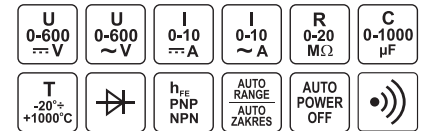

YATO
YT-73084 44

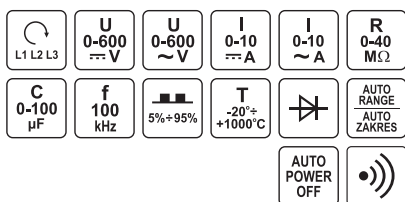

YATO
YT-73086 24

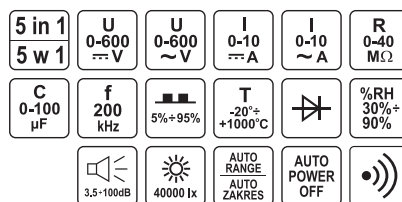

YATO
YT-73087 24

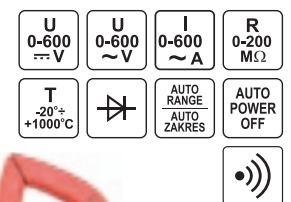

YATO
YT-73091 20

GB Electric glue gun
D Heißklebepistole
PL Pistolet do klejenia
RUS Пистолет для клея
CZ Pistole na lepení
H Ragasztópisztoly
RO Pistol pt. lipit
F Pistolet à colle
I Pistola colla
E Pistola de cola
CN 热胶枪

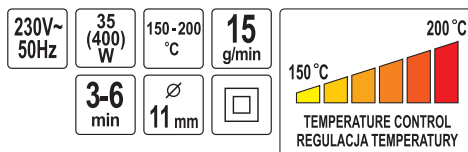

YATO
YT-82401 W 35 (400) diameter of glue stick średnica wkładu (mm) 11 capacity wydajność (g/min) 15 12/24

GB Soldering station
D Lötstation
PL Stacja lutownicza
RUS Паяльная станция
CZ Letovací stanice
H Forrasztópáka állomás
RO Stație de lipit
F Station de soudage
I Stazione digitale di saldatura
E Estación de soldadura
CN 数显焊台

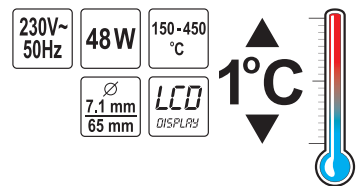

YATO
YT-82455 W 48 4

GB Soldering iron
D LötKolben
PL Lutownica orogowa
RUS Электропаяльник

CZ Pájka odporová
H Forrasztópáka
RO Ciocan de lipit
F Fer à souder

I Saldatore a stagno
E Soldador de resistencia
CN 电烙铁

230V~50Hz 400-520 °C 2-3 min



HANGING DISPLAY COLOR BOX

YATO	W	max. temperature of soldering tip / max. temperatura grotu (°C)	dimensions of soldering tip / wymiary grotu (mm)	
YT-8271	30	400	ø3.8 x 70	16
YT-8272	60	500	ø6.0 x 78	16
YT-8273	80	520	ø6.8 x 64	16

GB Transformer soldering gun
D Lötpestole
PL Lutownica transformatorowa
RUS Паяльник электрический
CZ Transformátorová páječka
H Forrasztópáka
RO Aparat de lipid letcon cu transformator
F Fer à souder

I Saldatore istantaneo
E Soldador transformador
CN 电烙铁

230V~50Hz 180 W WORKING MODE TRYB PRACY S2 20% LED



WORK LIGHT OŚWIETLENIE PRACY

BMC & COLOR SLEEVE

YATO	W	
YT-8245	180	10

GB Desoldering pump
D Entlötsaugpumpe
PL Odsysacz do sunu
RUS Шприц для удаления припоя
CZ Odrpájecí sací pumpa
H Önszipantó

RO Pompa fludor
F Pompe à étain
I Pompa aspira stagno
E Bomba desoldadora
CN 全铝手动吸锡器

SLIDING CARD

PTFE TIP



YATO	
YT-82742	100/400



YATO	
YT-82743	100/200



YATO	
YT-82744	50/100

GB Tweezer
D Pinzette
PL Pęseta
RUS Пинцет

CZ Pinzeta
H Csipesz
RO Pensetă
F Pince

I Pinza
E Pinzas
CN 镊子

SLIDING CARD

302 STAINLESS STEEL STAL NIERDZEWNA ANTI MAGNETIC ANTYMAGNETYCZNA ANTIACID KWASO-ODPORNA



140 mm HRC 30

YATO	L (mm)	
YT-6903	140	20/480



115 mm HRC 30

YATO	L (mm)	
YT-6907	115	20/480



140 mm HRC 40

YATO	L (mm)	
YT-6916	140	20/480



GB Insulation tape
D Isolierband
PL Taśma elektroizolacyjna
RUS Изолента

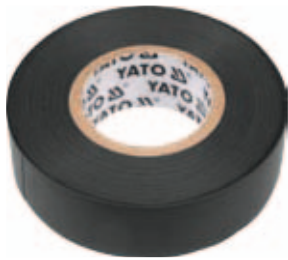

CZ Izolační páska
H Szigetelőszalag
RO Banda izolatoare
F Ruban électrique

I Nastro isolante
E Cinta aislante
CN 绝缘胶带



EN60454-3-1-1/F-PVC/60/R-Tp
DIELECTRIC STRENGTH / WYTRZYMAŁOŚĆ DIELEKTRYCZNA > 35 Kv / mm
ELONGATION / WYDLUŻENIE > 125%
FLAME TEST / TEST OGNIOWY < 1 s
STORE TEMPERATURE / TEMPERATURA SKŁADOWANIA +10°C ~ +40°C
USING TEMPERATURE / TEMPERATURA UŻYTKOWANIA +5°C ~ +50°C





YATO 	dimensions / wymiary	
YT-8152	12 mm x 10 m x 0.13 mm	96/384
YT-8159	15 mm x 20 m x 0.13 mm	72/288
YT-8165	19 mm x 20 m x 0.13 mm	72/288
YT-8174	25 mm x 20 m x 0.19 mm	48/192
YT-8177	50 mm x 33 m x 0.19 mm	48



YATO 	dimensions / wymiary	
YT-81592	15 mm x 20 m x 0.13 mm	72/288
YT-8166	19 mm x 20 m x 0.13 mm	72/288





YATO 	dimensions / wymiary	
YT-81591	15 mm x 20 m x 0.13 mm	72/288
YT-81651	19 mm x 20 m x 0.13 mm	72/288

YATO 	dimensions / wymiary	
YT-81594	15 mm x 20 m x 0.13 mm	72/288
YT-81654	19 mm x 20 m x 0.13 mm	72/288





YATO 	dimensions / wymiary	
YT-81593	15 mm x 20 m x 0.13 mm	72/288
YT-81655	19 mm x 20 m x 0.13 mm	72/288



YATO 	dimensions / wymiary	
YT-81595	15 mm x 20 m x 0.13 mm	72/288
YT-81652	19 mm x 20 m x 0.13 mm	72/288



10
PCS

10
PCS

YATO 	dimensions / wymiary	
YT-8156	12 mm x 10 m x 0.13 mm	10/40

YATO 	dimensions / wymiary	
YT-8173	19 mm x 20 m x 0.13 mm	6/24

GB Tool set for electricians
 D Werkzeug-Set für Elektriker
 PL Zestaw narzędziowy dla elektryków
 RUS Набор инструментов для электриков
 CZ Sada nářadí pro elektrikáře

H Szerszámkészlet villanyszerelők
 RO Set de instrumente pt. electricieni
 PL Un ensemble d'outils pour les électriciens

I Set per l'elettricista
 E Um conjunto de ferramentas para electricistas
 CN 件电子绝缘工具组套

BMC & COLOR SLEEVE



68 PCS	1/4" 6.3mm
CrV 50BV30	CrV 6150
S2	1000 V
D'E	



- 1/4" (6.3 mm): 4, 4.5, 5, 5.5, 6, 7, 8, 9, 10, 11, 12, 13 mm (L=25 mm); CrV 50BV30;
- 140 mm; 190 mm; 3CRB; 150 mm;
- 160 mm; 1000 V; CrV; 160 mm; 1000 V; CrV;
- 3 m x 16 mm; 175 mm; 19.5 x 190 mm;
- 1.5 V; 9 LED; 9 mm; 19 mm x 20 mm;
- 1/4" (6.3 mm): (150 mm); CrV 50BV30;
- 1/4" (6.3 mm) x 1/4" (6.3 mm); CrV 6140; 10 g;
- 1.4, 2, 2.4 mm; PH00, PH0, PH1; S2;
- 4x75, 5.5x125, PH1x80, PH2x100 mm; 1000V; S2;
- 1/4" (6.3 mm): 3, 4, 5, 5.5, 6 mm (L=25 mm); AISI S2;
- 1/4" (6.3 mm): PH1, PH2, PH3 (L=25 mm); AISI S2;
- 1/4" (6.3 mm): T8, T10, T15, T20, T25, T27 (L=25 mm); AISI S2;
- 1/4" (6.3 mm): 2, 2.5, 3, 4, 5, 6 (L=25 mm); AISI S2;
- 1.5, 2, 2.5, 3, 4, 5, 6, 7, 8, 10 mm; CrV 6150



U 0-500 V	U 0-500 V	I 0-5 A	R 0-2 MΩ	+
h _{FE} PNP NPN		5V _{P-P}	Ⓜ	



12-250 V	50-500 Hz	LCD DISPLAY	NO BATTERY NEEDED NE POTRZEBUJE BATERII
-------------	--------------	----------------	--



30W	230V~ 50Hz	400°C	TIP Ø3.8x70 mm
-----	---------------	-------	-------------------

YATO	1/4" (6.3 mm)	2
YT-39009		

GB Electrical clip assortment
D Krokodil-Klemmen-Kortiment
PL Zestaw złączy elektrycznych - krokodylki
RUS Набор разъемов - крокодил

CZ Terminal alligator krokodil příchyték
H Krokodil csipesz keszlet
RO Sortiment cleme crocodil
F Assortiment pinces crocodile

I Set di perni per misure e prove
E Crocodile clip
CN 件套夹头组套

PLASTIC
HANGING BOX



28
PCS

MIX
SIZE
ROZMIARÓW



10 pcs / sztuk - Alligator - clip without insulation / Krokodylki niezolowane
6 pcs / sztuk - Alligator - clip insulation / Krokodylki izolowane
4 pcs / sztuk - Big charging clip insulation / Zaciski duże izolowane
6 pcs / sztuk - Mini alligator - clip / Krokodylki male izolowane
2 pcs / sztuk - Small charging clip insulation / Zaciski male izolowane

YATO	dimensions / wymiary (mm)	
YT-06870	50; 55; 60; 65; 70; 80	5/20

7

GB Terminal connectors
D Kabelschuhe schnellkupplung
kabelklemme
PL Zestaw szybkozłączy elektrycznych

RUS Набор экспресс-клемм
CZ Kabelova rychlospojka
H Gyors csatlakozó auto
RO Conector rapid pt. auto

F Connecteur rapide
I Connettori terminali
E Conector rapido electrico
CN 件套连接片组套

PLASTIC
HANGING BOX



50
PCS

MIX
SIZE
ROZMIARÓW

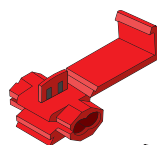

0.5 - 1.5 mm²

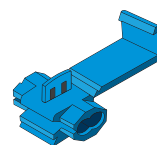
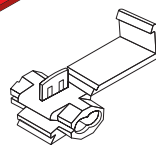

1.5 - 2.5 mm²

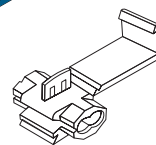

YATO	dimensions / wymiary (mm ²)	
YT-06868	0.5 - 1.5; 1.5 - 2.5	5/20

GB Heat-shrink tubing set
D Schrumpfschlauch - Sortiment
PL Zestaw koszulek termokurczliwych
RUS Набор термоусадочных трубок

CZ Smřšťovací bužirka tepelně
H Hőre zsugorodó cső szettek
RO Set tuburi termocontractabile
F Gaine thermoretractable coffret

I Tubo termoretraibile per isolare
E Surtido tubo de conexión
eléctrica cable manga
CN 件套热收缩管

PLASTIC
HANGING BOX



127
PCS

MIX
SIZE
ROZMIARÓW

125°C
max.

600 V
max.



Ø 2.0 x 40, 2.5 x 40, 3.5 x 40, 5.0 x 40, 7.0 x 80, 10.0 x 80, 13.0 x 85 mm

YATO		
YT-06866		5/20

8

**Hammers, chisels,
punches & axes**
**Młotki, dłuta,
przecinaki i siekiery**



Machinist hammers Młotki ślusarskie	
154	

Ball pein hammers & sets Młotki blacharskie i zestawy	
157	

Stoning hammers Młotki kamieniarskie	
154	

Chisels, cold chisels & punches Dłuta, przecinaki i przebijaki	
158-160	

Hammers with tubular steel handle Młotki z trzonkiem rurowym	
155	

Wood chisels & sets Dłuta stolarskie i zestawy.....	158
Cold chisels Przecinaki.....	158
Punches Przebijaki.....	158
Pin punches Wybijaki.....	159
Punches Punktaki.....	159
Cold chisel & punch sets Zestawy przecinaków i punktaków.....	159

Claw hammers Młotki szewskie.....	155
Roofing hammers Młotki ciesielskie.....	155
Mason's hammers Młotki murarskie.....	155
Plasterer's hatchets Toporki tynkarskie.....	155

Wrecking bars Łomy	
161	

Fully drop forged hammers Młotki monolityczne kute	
155	

Axes Siekiery	
161	

Claw hammers Młotki szewskie.....	155
Roofing hammers Młotki ciesielskie.....	155
Mason's hammers Młotki murarskie.....	155

Adzes Ciosła	
161	

Rubber mallets Młotki gumowe	
156	

Dead blow hammers Młotki bezodrzutowe	
156	

GB Machinist hammer CZ Zámečnické kladívko I Martello da aggiustatore
 D Schlosserhammer H Vaskalapács E Martillo
 PL Młotek ślusarski RO Ciocan de lăcătușerie CN 钳工锤
 RUS Молоток слесарный F Marteau serrurier

DIN
1041



YATO	m (g)	L (mm)	A (mm)	H (mm)	
YT-4491	100	260	15	80	12/120
YT-4492	200	280	20	93	6/60
YT-4493	300	300	21	103	6/60
YT-4494	400	310	23	111	6/48
YT-4495	500	320	26	118	6/36

YATO	m (g)	L (mm)	A (mm)	H (mm)	
YT-4496	600	330	28	119	6/36
YT-4497	800	350	31	125	6/24
YT-4498	1000	360	35	132	6/24
YT-4499	1500	380	40	143	6/12
YT-4500	2000	400	45	153	6/12

8



YATO	m (g)	L (mm)	A (mm)	H (mm)	
YT-4501	100	260	15	82	12/120
YT-4502	200	280	19	95	6/60
YT-4503	300	300	23	105	6/60
YT-4504	400	310	25	112	6/48
YT-4505	500	320	27	118	6/36

YATO	m (g)	L (mm)	A (mm)	H (mm)	
YT-4506	600	330	29	122	6/36
YT-4507	800	350	33	135	6/24
YT-4508	1000	360	36	135	6/24
YT-4509	1500	380	42	145	6/12
YT-4510	2000	400	47	155	6/12

GB Safety stoning hammer H Kőtörő kalapács I Martello da aggiustatore
 D Faustel RO Ciocan pt. zidarie E Martillo
 PL Młotek kamieniarski F Marteau de tailleur de pierres CN 石工锤
 RUS Молоток каменщика
 CZ Palička kovová

DIN
6475



YATO	m (g)	L (mm)	A (mm)	H (mm)	
YT-4550	1000	260	40	95	6/24
YT-4551	1250	260	43	100	6/24

YATO	m (g)	L (mm)	A (mm)	H (mm)	
YT-4552	1500	280	45	110	6/12
YT-4553	2000	300	50	120	6/12

GB Claw hammer
D Schusterhammer
PL Młotek szewski
RUS Молоток гвоздодёр
CZ Sevcovské kladívko
H Cipész kalapács

RO Ciocan de cizmărie
F Marteau de cordonnier
I Martello calzolaio
E Martillo sacador
CN 羊角锤



- high quality steel handle
- forged carbon steel head hardened and tempered
- stalowy trzonek
- bijak ze stali węglowej, kuty, ulepszony cieplnie

YATO	m (g)	L (mm)	A (mm)	H (mm)	
YT-4560	450	318	30	130	6/24

GB Roofing hammer
D Latthammer Geschmiedet
PL Młotek ciesielski
RUS Молоток жестящика
CZ Tesařské kladívko

H Ácskalapács
RO Ciocan de dulgherie
F Marteau de charpentier

I Martello per carpentiere
E Martillo techumbre
CN 独角锤



- high quality steel handle
- forged carbon steel head hardened and tempered
- stalowy trzonek
- bijak ze stali węglowej, kuty, ulepszony cieplnie

YATO	m (g)	L (mm)	A (mm)	H (mm)	
YT-4561	600	318	25x25	165	6/24

GB Mason's hammer, type B
D Berliner Mauerhammer
PL Młotek murarski berliński
RUS Молоток каменщика широкий

F Marteau de maçon
I Martello muratore tipo Berlin
E Martillo de albañil de Berlin
CN B型泥工锤



- high quality steel handle
- forged carbon steel head hardened and tempered
- stalowy trzonek
- bijak ze stali węglowej, kuty, ulepszony cieplnie

YATO	m (g)	L (mm)	A (mm)	H (mm)	
YT-4562	600	315	24x23	200	6/24

GB Mason's hammer, type R
D Mauerhammer Rheinische Form
PL Młotek murarski reński
RUS Молоток каменщика узкий
CZ Zednické kladívko renské
H Kőműves kalapács, rajnai típus

RO Ciocan de zidărie (tip ren)
F Marteau de maçon
I Martello muratore tipo rin
E Martillo de albañil de Rin
CN R型泥工锤



- high quality steel handle
- forged carbon steel head hardened and tempered
- stalowy trzonek
- bijak ze stali węglowej, kuty, ulepszony cieplnie

YATO	m (g)	L (mm)	A (mm)	H (mm)	
YT-4563	600	315	23x23	170	6/24

GB Plasterer's hatchet
D Gipserbeil
PL Toporek tynkarski
RUS Топор штукатурный
CZ Omitáči sekyrka
H Kőműves szekerce
RO Toporaș de tencuit
F Hachette de plâtrier
I Martello con accetta
E Hacha enlucido
CN 多用斧



- high quality steel handle
- forged carbon steel head hardened and tempered
- stalowy trzonek
- bijak ze stali węglowej, kuty, ulepszony cieplnie

YATO	m (g)	L (mm)	A (mm)	H (mm)	
YT-4564	600	315	25x20	175	6/24

GB Claw hammer
D Schusterhammer
PL Młotek szewski
RUS Молоток гвоздодёр
CZ Sevcovské kladívko
H Cipész kalapács
RO Ciocan de cizmărie
F Marteau de cordonnier
I Martello calzolaio
E Martillo sacador
CN 连体羊角锤



- high quality steel handle
- forged carbon steel head hardened and tempered
- stalowy trzonek
- bijak ze stali węglowej, kuty, ulepszony cieplnie

YATO	m (g)	L (mm)	A (mm)	H (mm)	
YT-4570	450	315	30	130	6/24

GB Roofing hammer
D Latthammer Geschmiedet
PL Młotek ciesielski
RUS Молоток жестящика
CZ Tesařské kladívko
H Ácskalapács
RO Ciocan de dulgherie

F Marteau de charpentier
I Martello calzolaio
E Martillo techumbre
CN 连体独角锤



- high quality steel handle
- forged carbon steel head hardened and tempered
- stalowy trzonek
- bijak ze stali węglowej, kuty, ulepszony cieplnie

YATO	m (g)	L (mm)	A (mm)	H (mm)	
YT-4571	600	331	25x25	165	6/24

GB Mason's hammer, type R
D Mauerhammer Rheinische Form
PL Młotek murarski reński
RUS Молоток каменщика узкий
CZ Zednické kladívko renské
H Kőműves kalapács, rajnai típus

RO Ciocan de zidărie (tip ren)
F Marteau de maçon
I Martello muratore tipo rin
E Martillo de albañil de Rin
CN 连体R型泥工锤





- high quality steel handle
- forged carbon steel head hardened and tempered
- stalowy trzonek
- bijak ze stali węglowej, kuty, ulepszony cieplnie

YATO	m (g)	L (mm)	A (mm)	H (mm)	
YT-4573	600	382	25x24	158	6/24



- GB Rubber mallet with fibreglass, TPR handle
- D Gummihammer mit Fiberglasstiel
- PL Młotek gumowy z trzonkiem z włókna szklanego
- RUS Киянка резиновая со стеклопластиковой ручкой
- CZ Pryžové kladívko
- H Gumikalapács
- RO Ciocan de cauciuc
- F Maillet caoutchouc
- I Martello mazzuola in gomma
- E Mazo de goma
- CN 纤维柄橡胶锤



YATO 	m (g)	L (mm)	Ø (mm)	H (mm)	
YT-4594	440	340	50	87.5	6/36

- GB Rubber mallet with wooden handle
- D Gummihammer mit Holzstiel
- PL Młotek gumowy z drewnianym trzonkiem
- RUS Молоток резиновый
- CZ Pryžové kladívko
- H Gumikalapács
- RO Ciocan de cauciuc
- F Maillet caoutchouc
- I Martello mazzuola in gomma
- E Mazo de goma
- CN 木柄橡胶锤





YATO 	m (g)	L (mm)	Ø (mm)	H (mm)	
YT-4600	230	259	44	71.0	12/48
YT-4601	340	291	49	79.5	12/48
YT-4602	370	300	50	87.5	6/36
YT-4603	580	341	58	96.0	6/36
YT-4604	780	341	63	117.0	6/36
YT-4605	980	345	72	122.0	6/24

- GB Dead blow mallet
- D Rückschlagsfreier Schonhammer
- PL Młotek bezodrzutowy
- RUS Молоток безинерционный
- CZ Palička nárazová plněná celogumová
- H Visszarúgás mentes gumikalapács
- RO Ciocan cu absorbție
- F Maillet sans recul
- I Martello morto colpo
- E Martillo sin reacción
- CN 防震无回弹橡胶锤



PU





YATO 	m (g)	L (mm)	Ø (mm)	H (mm)	
YT-4620	740	300	44.5	100.0	4/24
YT-4622	900	336	53.5	100.0	4/24
YT-4623	1300	350	59.0	118.5	3/12

- GB Dead blow mallet
- D Rückschlagsfreier Schonhammer
- PL Młotek bezodrzutowy
- RUS Молоток безинерционный
- CZ Palička nárazová plněná celogumová
- H Visszarúgás mentes gumikalapács
- RO Ciocan cu absorbție
- F Maillet sans recul
- I Martello morto colpo
- E Martillo sin reacción
- CN 尼龙安装锤





PU

YATO 	m (g)	L (mm)	Ø (mm)	H (mm)	
YT-4624	265	318	30.0	94	10/40
YT-4625	430	350	40.0	100	6/36
YT-4626	490	348	45.0	110	6/36

- GB PU & nylon heads mallet
- D Schonhammer mit PU & Nylon-Schlagkopf
- PL Młotek blacharski
- RUS Молоток рихтовочный
- CZ Palička klempířská
- H Vaskalapács
- RO Ciocan tinichigerie cap PU / nylon
- F Marteau spécial en PU / nylon
- I Martello per lamiera
- E Martillo chapista
- CN 木柄安装锤



PU **NYLON**

YATO 	m (g)	L (mm)	Ø (mm)	H (mm)	
YT-4630	150	250	22	75	6/48
YT-4631	250	280	28	85	6/36
YT-4632	340	315	35	95	6/36
YT-4633	660	350	45	105	6/24
YT-4634	1340	380	60	132	4/16

- GB Auto body fender set
D Karosserie-Ausbeulsatz
PL Komplet młotków blacharskich
RUS Молотки рихтовочные
CZ Souprava klempířských kladívek
H Bádogos kalapács készlet
- RO Set de ciocane de tablă
F Set pour carrossier
I Martello per lamiera
E Juego de mazos de hojalatero
CN 钣金工具组套

7
PCS



DROP
FORGED
KUTE

GENUINE
HICKORY



BMC
& COLOR
SLEEVE





YATO 	m (g)	
YT-4590	4900	4

- GB Ball pein hammer
D Ausbeulhammer
PL Młotek blacharski
RUS Молоток рихтовочный
CZ Klempířské kladívko
H Bádogos kalapács
- RO Ciocan pt. tabla
F Marteau à panne ronde
I Martello per lamiera
E Martillo de hojalatero
CN 圆头锤

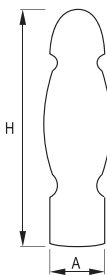

FIBREGLOSS
WŁÓKNO
SZKLANE

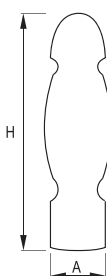

YATO 	m (g)	L (mm)	A (mm)	H (mm)	
YT-4515	225	280	26	80	6/36
YT-4516	450	315	34	100	6/24
YT-4518	900	380	40	125	6/12

- GB Ball pein hammer
D Ausbeulhammer
PL Młotek blacharski
RUS Молоток рихтовочный
CZ Klempířské kladívko
H Bádogos kalapács
- RO Ciocan pt. tabla
F Marteau à panne ronde
I Martello per lamiera
E Martillo de hojalatero
CN 圆头锤



YATO 	m (g)	L (mm)	A (mm)	H (mm)	
YT-4519	225	295	26	80	6/36
YT-4520	450	335	35	100	6/24
YT-4521	680	360	36	115	6/12
YT-4522	900	380	40	125	6/12

GB Wood chisel
 D Stechbeitel
 PL Dłuto stolarskie
 RUS Долото
 CZ Rezbáňské dláto
 H Asztalos véső

RO Daltă de tâmplărie
 F Ciseau
 I Scalpello
 per falegname
 E Cincel para madera
 CN 木工凿

DOUBLE BLISTER

CrV 60
 HRC 56-62



YATO	size / rozmiar (mm)	
YT-6241	8	10/60
YT-6242	10	10/60
YT-6243	12	10/60
YT-6244	14	10/60
YT-6245	15	10/60
YT-6246	16	10/60
YT-6247	18	10/60

YATO	size / rozmiar (mm)	
YT-6248	20	10/60
YT-6249	22	10/60
YT-6251	25	10/60
YT-6253	28	10/60
YT-6256	35	10/60
YT-6258	38	10/60

GB Chisel set
 D Meißelsatz
 PL Zestaw dłut
 RUS Набор зубил

CZ Sada dlát
 H Hidegvágó készlet
 RO Set de dălți
 F Set de ciseaux à bois

I Set scalpelli
 E Juego de cinceles
 CN 木工凿组套

4 PCS
 10 16 20 25 mm
 CrV 60
 HRC 58-60



YATO	
YT-6260	5/20

GB Chisel set
 D Meißelsatz
 PL Zestaw dłut
 RUS Набор зубил

CZ Sada dlát
 H Hidegvágó készlet
 RO Set de dălți
 F Set de ciseaux à bois

I Set scalpelli
 E Juego de cinceles
 CN 木工凿组套

3 PCS
 CrV
 16 25 32 mm



PLASTIC HANGER

YATO	
YT-6280	10/30



PLASTIC HANGER

YATO	
YT-6281	6/24

GB Cold chisel with protection
 D Schlitzmeißel mit Handschutz
 PL Przecinak z osłoną
 RUS Зубило с протектором
 CZ Plochý sekáč (z krytem)
 H Hidegvágó, lapos (védőfejjel)

RO Daltă - tăietor
 plată (cu apărătoare)
 F Burin
 I Scalpello con protezione
 E Cincel plano (con protector)
 CN 石工凿

25x300 mm
 CrV



PLASTIC HANGER

YATO	L (mm)	
YT-4700	300	4/24

GB Cold chisel with protection
 D Schlitzmeißel mit Handschutz
 PL Przecinak z osłoną
 RUS Зубило с протектором
 CZ Plochý sekáč (z krytem)
 H Hidegvágó, lapos (védőfejjel)
 RO Daltă - tăietor plată (cu apărătoare)

F Burin
 I Scalpello con protezione
 E Cincel plano (con protector)
 CN 石工凿

76x267 mm
 CrV



PLASTIC HANGER

YATO	L (mm)	
YT-4701	267	4/24

GB Punch with protection
 D Spitzmeißel mit Handschutz
 PL Przebijak z osłoną
 RUS Скарпель с пластмассовой ручкой
 CZ Zednický průbojník (z krytem)
 H Falvéső (védőfejjel)
 RO Dom (perforator) pt. perete (cu apărătoare)
 F Percoir
 I Scalpello a punta con protezione
 E Cincel de cerrajería con protector
 CN 水泥尖凿

300 mm
 CrV



PLASTIC HANGER

YATO	L (mm)	
YT-4705	300	4/24

GB Chisel and punch set
 D Trennmeißel- und Durchtreiber-Satz
 PL Zestaw przecinaków i punktaków
 RUS Зубила и пробойники с протектором
 CZ Sekáče a průbojníky
 H Véső és lyukasztó készlet

RO Set dalti de impact
 F Kit de burins et perçoirs
 I Scalpelli e bulino
 E Juego de cinceles de acero templado y punzones
 CN 冲凿组套

6 PCS
 CHISEL 12x180 mm 16x180 mm 19x180 mm
 PUNCH 3x180 mm 3x180 mm 4x180 mm
 CrV



PLASTIC HANGER



YATO	L (mm)	
YT-4710	180	10/20

- GB** Cold chisel
D Flachmeißel
PL Przecinak płaski
RUS Зубило плоское
CZ Sekáč plochý
H Laposvágó
RO Dalta lata
F Burin
I Scalpello a punta
E Tajadera en frío
CN 凿子



CrV
6150

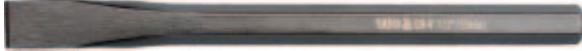

SLIDING
CARD

YATO	L (mm)	chisel width / szerokość dłuta (mm)	
YT-47147	142	10.0	20/120
YT-47148	152	12.5	20/120
YT-47149	172	16.0	20/120

- GB** Taper punch
D Durchtreiber
PL Wybijał równoległy
RUS Пробойник конусный
CZ Průbojník
H Lyukasztó
RO Dorn conic
F Percuteur
I Scalpello a punta
E Retacador de cono
CN 冲子

150
mm



CrV
6150



SLIDING
CARD

YATO	L (mm)	pin diameter / średnica grotu (mm)	
YT-47141	150	1.5	20/120
YT-47142	150	3.0	20/120
YT-47143	150	4.0	20/120
YT-47144	150	5.0	20/120
YT-47145	150	6.0	20/120
YT-47146	150	8.0	20/120

- GB** Taper punch
D Durchtreiber
PL Dobijak stożkowy
RUS Пробойник конусный
CZ Průbojník
H Lyukasztó
RO Dorn conic
F Matoir
I Scalpello a punta
E Retacador de cono
CN 冲子

SLIDING
CARD



140
mm



CrV
6150



YATO	L (mm)	center punch / średnica punktaka (mm)	
YT-47152	140	2.0	20/120

- GB** Center punch
D Körner
PL Punktak
RUS Пробойник - керн
CZ Důlčik
H Pontozó
RO Punctator
F Pointeau
I Punzoni
E Retacador - punzón centrador
CN 冲子

SLIDING
CARD



CrV
6150



YATO	L (mm)	taper point end / średnica stożka (mm)	
YT-47150	100	6.0	20/120
YT-47151	112	8.0	20/120

- GB** Pin punch set
D Splintentreiber Satz
PL Zestaw wybijaaków
RUS Пробойник булавочный- набор
CZ Sada vyrážečů
H Csapszegkiütő készlet
RO Set de dornuri
F Set de perceuteurs
I Set scalpelli
E Juego de punzones
CN 销式冲子组套

SLIDING
CARD



6
PCS

150
mm



PN DIAMETER
1.5, 3.0, 4.0,
5.0, 6.0,
8.0 mm

CrV
6150



YATO	L (mm)	
YT-47121	150	6/24

- GB** Chisel set
D Flachmeißelsatz
PL Zestaw przecinaków
RUS Зубила в наборе
CZ Sekáče
H Hidegvágó
RO Set dalti zidarie
F Set de burins
I Set scalpelli
E Cinceles
CN 冲凿组套

PLASTIC
HANGER



3
PCS

CHISEL
10x142 mm
12x152 mm
16x172 mm

CrV



- GB** Chisel and punch set
D Trennmeißel- und Durchtreiber-Satz
PL Zestaw przecinaków i punktaków
RUS Зубила, керны и пробойники в наборе
CZ Sekáče a průbojníky
H Véső és lyukasztó készlet
RO Set dalti de impact
F Set de burins et pointeaux
I Set scalpelli
E Juego de cinceles de acero templado y punzones
CN 冲凿组套

PLASTIC
HANGER



6
PCS

CHISEL
10x142
12x152
mm

PUNCH
2x140 mm
3x152 mm
8x152 mm
8x115 mm

CrV



YATO	
YT-4711	6/24

YATO	
YT-4712	6/24

GB Mini cold chisel and punch set
 D Trennmeissel- und Durchtreiber-Satz
 PL Zestaw wybijaków i przecinaków
 RUS Зубила и керны в наборе
 CZ Sekáče a průbojníky
 H Véső és lyukasztó készlet
 RO Set dalti de impact
 F Set de burins et perceuteurs mini
 I Set scalpelli e bulini
 E Juego de cinceles de acero templado y punzones
 CN 迷你冲凿组套

PLASTIC HANGER



3 PCS 125 mm
 CrV COLD CHISEL: 10 mm
 PIN PUNCH: 3 mm SOLID PUNCH: 3 mm



YATO YT-4713 10/60

GB Chisel and punch set
 D Trennmeissel- und Durchtreiber-Satz
 PL Zestaw przecinaków i punktaków
 RUS Зубила, керны и пробойники в наборе
 CZ Sekáče a průbojníky
 H Véső és lyukasztó készlet
 RO Set dalti de impact
 F Set de burins et pointeaux
 I Set scalpelli
 E Juego de cinceles de acero templado y punzones
 CN 冲凿组套

PLASTIC HANGER



12 PCS CrV SOLID PUNCH: 4 mm CENTER PUNCH: 90 DEGR. 6 mm 8 mm
 PIN PUNCH: 1.5 mm 3 mm 4 mm 5 mm 6 mm 8 mm
 COLD CHISEL: 10 mm 13 mm 16 mm



YATO YT-4714 10/20

GB Pin punch
 D Splintentreiber
 PL Wybijak
 RUS Пробойник булавочный
 CZ Vyrážec
 H Csapszegkiütő

RO Dorn cilindric
 F Percuteur
 I Punzoni
 E Punzón expulsador
 CN 销式冲子

SLIDING CARD



150 mm CrV 60 PIN DIAMETER: Ø 3.8 mm



YATO YT-4690 L (mm) 150 20/120

GB Taper punch
 D Durchtreiber
 PL Dobijak stożkowy
 RUS Пробойник конусный
 CZ Průbojník
 H Lyukasztó
 RO Dorn conic

F Matoir
 I Punzoni
 E Retacador de cono
 CN 冲孔器

SLIDING CARD



120 mm CrV 60 CENTER PUNCH: Ø 3.3 mm



YATO YT-4691 L (mm) 120 20/120

GB Center punch
 D Körner
 PL Punktak
 RUS Пробойник - керн
 CZ Důlčák
 H Pontozó

RO Puncator
 F Pointeau
 I Punzoni
 E Retacador
 CN - punzón centrador
 CN 冲子

SLIDING CARD



120 mm CrV 60 TAPER POINT END



YATO YT-4692 L (mm) 120 20/120

GB Cold chisel
 D Flach Meissel
 PL Przecinak płaski
 RUS Зубило плоское
 CZ Sekáč plochý
 H Laposvágó

RO Dalta lata
 F Burin plat
 I Scalpello piatto
 E Tajadera en frío
 CN 扁铲

SLIDING CARD



130 mm CrV 60 CHISEL WIDTH: 12 mm



YATO YT-4693 L (mm) 130 20/120

GB Cape chisel
 D Kreuzmeissel
 PL Przecinak krzyżowy
 RUS Зубило „лика”
 CZ Sekáč křížový
 H Keresztvágó
 RO Dalta ascuțita

F Burin
 I Scalpello rettangolare
 E Tajadera rectangular
 CN 钎头

SLIDING CARD



130 mm CrV 60 CHISEL WIDTH: 5.5 mm



YATO YT-4694 L (mm) 130 20/120

GB Chisel and punch set
 D Trennmeissel- und Durchtreiber-Satz
 PL Zestaw przecinaków i punktaków
 RUS Зубила и керны в наборе
 CZ Sekáče a průbojníky
 H Véső és lyukasztó készlet
 RO Set dalti de impact
 F Set de burins
 I Set scalpelli e bulino
 E Juego de cinceles de acero templado y punzones
 CN 样冲组套

SLIDING CARD



5 PCS CrV 60 PIN PUNCH: Ø 3.8 mm TAPER PUNCH: Ø 3.3 mm
 TAPER POINT END
 COLD CHISEL: 12 mm
 CAPE CHISEL: 5.5 mm



YATO YT-4695 6/24

GB Hexagonal wrecking bar
D Brechstange
PL Łom sześciokątny
RUS Лом-гвоздодёр шестигранный
CZ Šestiúhľé páčidlo
H Hatszögű feszítővas
RO Ranga pt. scos cuie
F Pied-de-biche manche hexagonal
I Mazza di ferro
E Palanqueta
CN 撬棒

DROP FORGED KUTE



YATO	size / rozmiar (mm)	
YT-46800	400x18	6/12
YT-46801	450x18	6/12
YT-46802	600x18	6/12
YT-46803	750x18	6/12
YT-46804	900x18	5/10

GB Profiled wrecking bar
D Nageleisen
PL Łom profilowany
RUS Лом-гвоздодёр
CZ Páčidlo
H Szögűhúzód
RO Ranga pt. scos cuie
F Pied-de-biche profilé
I Mazza di ferro
E Palanqueta
CN 撬棒

DROP FORGED KUTE



YATO	size / rozmiar (mm)	
YT-46810	350x22x13	6/12
YT-46811	450x30x17	6/12
YT-46812	600x30x17	4/8
YT-46813	750x30x17	4/8
YT-46814	900x30x17	3/6

GB Flat wrecking bar
D Nageleisen spitze
PL Łom płaski
RUS Лом плоский
CZ Páčidlo ploché
H Lapos feszítővas
RO Ranga plata
F Pied-de-biche plat
I Mazza di ferro
E Palanqueta
CN 撬棒

DROP FORGED KUTE

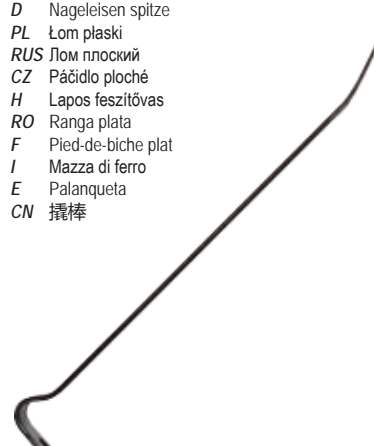

YATO	size / rozmiar (mm)	
YT-46820	300x35x6	10/30
YT-46821	380x35x6	10/20
YT-46822	450x35x6	10/20
YT-46823	600x35x6	10/20

GB Go-through pry bar set
D Nageleisensatz
PL Zestaw łomów
RUS Набор ломов
CZ Sada mini páčidel
H Szögűhúzód készlet
RO Set leviere
F Set de pieds-de-biche
I Set mazza di ferro
E Juego de palancas de hierro
CN 穿心撬棒组套

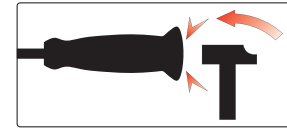

4 PCS

- 198x6x6 mm, 110 g
- 304x10x10 mm, 292 g
- 456x10x10 mm, 479 g
- 608x12x12 mm, 745 g

DOUBLE BLISTER

YATO		
YT-4730		3/6

GB Axe
D Beil
PL Siekiera
RUS Топор
CZ Sekerka
H Szekerce
RO Secure
F Hache
I Ascia
E Hacha
CN 把斧

GENUINE HICKORY



Timber wedge and steel ring
 Drewniany klin ze stalowym pierścieniem

Genuine hickory shaft
 Trzonek z hikory

Forged carbon steel head hardened and tempered
 Głowica z kutej stali węglowej, hartowana i utwardzona

DIN 5131 7294

YATO	m (g)	L (mm)	DIN	
YT-8001	600	360	5131	24
YT-8002	800	380	5131	20
YT-8003	1000	430	5131	12
YT-8004	1250	710	7294	12
YT-8005	1400	710	7294	12
YT-8006	1600	810	7294	12

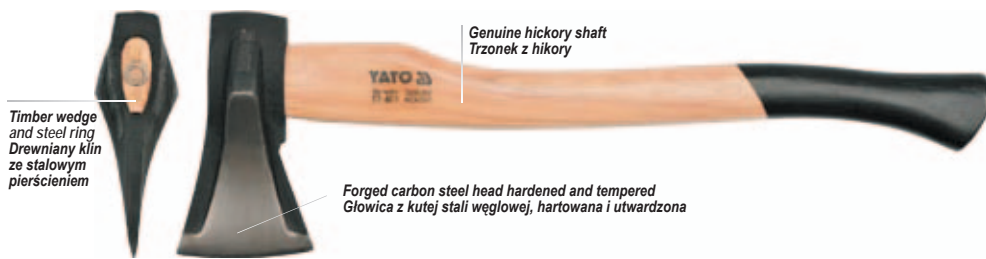

Timber wedge and steel ring
 Drewniany klin ze stalowym pierścieniem

Genuine hickory shaft
 Trzonek z hikory

Forged carbon steel head hardened and tempered
 Głowica z kutej stali węglowej, hartowana i utwardzona

YATO	m (g)	L (mm)	
YT-8011	1000	515	6
YT-8012	2000	820	6

GB Adze flat type
D Flachdaxel
PL Ciosło płaskie
RUS Тесло плоское
CZ Sekyrka
H Szekerce
RO Tesla
F Hache d'artisans
I Ascia tipo piatto
E Destral de artesanos
CN 扁斧



YATO		
YT-80130		4/24

9

Clamps, vices & holders Ściski, imadła i wsporniki



Clamps
Ściski

164-165



Magnetic holders
Wsporniki magnetyczne

167



Vices
Imadła

166



- GB F-clamp
- D Schraubzwinge
- PL Ścisk stolarski
- RUS Струбцина
- CZ Truhlářské upínadlo
- H Asztalos szorító
- RO Menghină pt. tâmplărie
- F Presse à serrage pour menuisier
- I Morsetto da falegname
- E Tornillo de apriete
- CN F夹钳

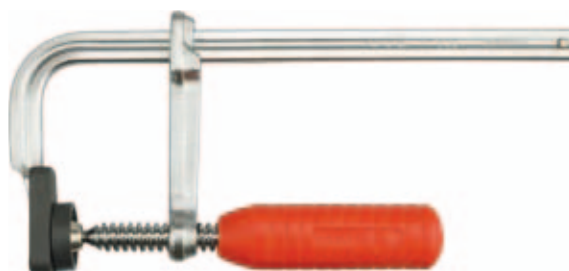

**QUICK
ADJUSTMENT
SZYBKĄ
REGULACJĄ**

YATO	L (mm)	
YT-6401	160x80	10/30
YT-6402	200x80	10/30
YT-6403	250x80	10/30
YT-6404	300x80	10/30
YT-6405	450x80	10/20
YT-6406	600x80	10/20
YT-6407	400x120	10
YT-6408	500x120	10
YT-6409	600x120	10
YT-6410	900x120	5



**QUICK
ADJUSTMENT
SZYBKĄ
REGULACJĄ**

YATO	L (mm)	
YT-6412	300x120	10
YT-6413	400x120	10
YT-6414	500x120	5
YT-6415	600x120	5
YT-6416	900x120	5
YT-6417	1050x120	5



YATO	L (mm)	
YT-6440	100x50	12/60
YT-6441	150x50	12/48
YT-6442	200x50	12/48
YT-6443	250x50	12/48
YT-6444	300x50	12/48
YT-6445	200x80	10/20
YT-6446	250x80	10/20
YT-6447	300x80	10/20
YT-6448	500x80	10/20
YT-6449	300x120	10
YT-6450	500x120	10
YT-6451	800x120	6
YT-6452	1000x120	6
YT-6453	1200x120	6
YT-6454	1500x120	6

- GB Bar clamp ratchet
- RUS Струбцина
- H Bár bilincs racsnis
- I Bar morsetto a cricchetto
- D Lenkerklemmung Ratsche
- RO Presă tip „F” cu clichet
- E Barra de mordaza de trinquette
- CN 棘轮F夹
- PL Ścisk stolarski zapadkowy
- CZ Svěrka s ráčnou
- F Bar pince a cliquet



YATO	L (mm)	
YT-63951	200x100	2/12
YT-63952	250x100	2/12
YT-63953	300x100	2/12
YT-63954	400x100	2/6
YT-63955	500x120	2/4
YT-63956	600x120	2/4
YT-63957	800x120	2/4
YT-63958	1000x120	2

- GB Spring clamp
- D Federklemme
- PL Ścisk sprężynowy
- RUS Струбцина
- CZ Pružinové upínadlo
- H Rugós szorító
- RO Cleste presa pt. lemn
- F Pince de serrage
- I Morsetto a molla
- E Pinza
- CN 弹簧夹





YATO	L (mm)	max. jaws range / max. zasięg szczęk (mm)	max. jaws depth / max. głębokość szczęk (mm)	
YT-64270	100	42	44	24/240
YT-64271	150	55	68	12/120
YT-64272	200	79	91	10/100

- GB Insulated spring clamp
D Federklemme vollisoliert
PL Ścisk sprężynowy izolowany
RUS Струбцина изолированная
CZ Pružinové upínadlo izolované
H Rugós szorító
RO Cleste presa pt. lemn izolat
F Pince de serrage isolée
I Pinza di bloccaggio isolate
E Pinza aislante
CN 弹簧夹



150 mm CrV 1000 V 



1000V
VDE CERTIFICATE
EN 60900:2012

YATO 	working capacity / zakres pracy (mm)	L (mm)	
YT-21190	2-20	150	5/40



- GB C-Clamp
D C-Schraubzwinde
PL Ścisk typu „C”
RUS Струбцина типа „С”
CZ Svěrka tvaru „C”
H Pillanatszorító
RO Menghina tip „C”
F Serre-joint
I Morsetto tipo „C”
E Tornillo tipo „C”
CN 深喉型C型夹



DROP FORGED KUTE

YATO 	size / rozmiar (mm)	force pressure / siła nacisku (kg)	
YT-6420	50	1500	6/30
YT-6421	75	1950	6/18
YT-6422	100	2980	6/12
YT-6423	150	3200	6/12
YT-6424	200	3600	6



YATO 	size / rozmiar (mm)	force pressure / siła nacisku (kg)	
YT-64250	25	120	100
YT-64251	50	200	50
YT-64252	75	280	30
YT-64253	100	350	30
YT-64254	125	390	18
YT-64255	150	450	12
YT-64256	200	500	10
YT-64257	250	540	5
YT-64258	300	600	5

- GB Swivel base bench vice
- D Drehbare Schraubstock
- PL Imadło ślusarskie obrotowe
- RUS Тиски слесарные поворотные
- CZ Zámečnický svěrák otáčivě
- H Satu, lakatos forgó
- RO Menghină rotativă
- F Étau rotatif de serrurier
- I Morsa a cerniera
- E Tornillo de apriete giratorio
- CN 台虎钳

COLOR BOX



- GB Swivel base bench vice
- D Drehbare Schraubstock
- PL Imadło ślusarskie obrotowe
- RUS Тиски слесарные поворотные
- CZ Zámečnický svěrák otáčivě
- H Satu, lakatos forgó
- RO Menghină rotativă
- F Étau rotatif de serrurier
- I Morsa a cerniera
- E Tornillo de apriete giratorio
- CN 台虎钳

COLOR BOX



- anvil and changeable jaws made of hardened steel
- kowadełko i wymienne szczęki z hartowanej stali

	7 kg	YATO YT-6501	weight (kg) waga (kg)	
			7	2
	10 kg	YATO YT-6502	weight (kg) waga (kg)	
			10	2
	15 kg	YATO YT-6503	weight (kg) waga (kg)	
			15	1
	19 kg	YATO YT-65048	weight (kg) waga (kg)	
			19	1
	21 kg	YATO YT-6504	weight (kg) waga (kg)	
			21	1
	29.5 kg	YATO YT-65049	weight (kg) waga (kg)	
			29.5	1

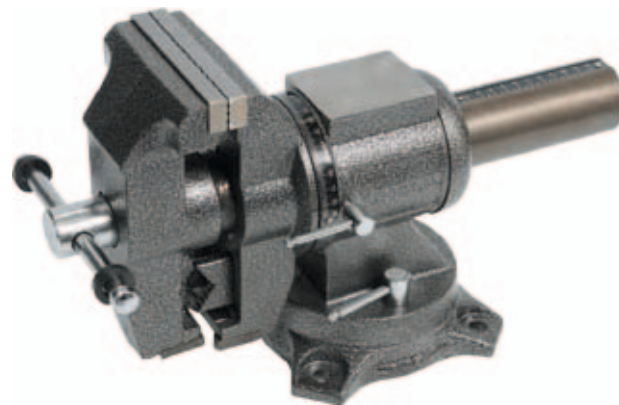

- anvil and changeable jaws made of hardened steel
- kowadełko i wymienne szczęki z hartowanej stali

				HRC 45-52 JAWS/SZCZĘKI	10 kg	YATO YT-6505	weight (kg) waga (kg)	
							10	1
				HRC 45-52 JAWS/SZCZĘKI	20 kg	YATO YT-6506	weight (kg) waga (kg)	
							20	1

- GB Hinged pipe vice
- D Rohrschraubstock
- PL Imadło zaciskowe do rur
- RUS Тиски для труб
- CZ Upinací svěrák na trubky
- H Satu, csőszorító
- RO Menghină pt. țevi
- F Étau de serrage à tuyaux
- I Morsa stringi tubo
- E Tornillo de apriete para tubos
- CN 管子台虎钳



S55C

COLOR BOX



YATO	Ø (mm)	
YT-6510	60	4
YT-6511	76	2
YT-6512	90	2
YT-6513	110	1

GB Adjustable angle welding magnet
D Verstellbarer Magnet-Werkstückhalter
PL Wspornik magnetyczny spawalniczy regulowany
RUS Регулируемый магнит заварки угла
CZ Polohovací magnetický držák ke svařování
H Állítható, mágneses, hegesztő támasz
RO Dispozitiv magnetic reglabil pt. sudura
F Support magnétique de soudure
I Supporto della saldatura magnetico
E Soporte magnético de soldadura, ajustable
CN 焊接磁铁



DOUBLE
BLISTER



YATO	(kg)	mm	
YT-0862	2x22.5	85x65x22	6

GB Magnetic welding holder
D Magnet-Werkstückhalter
PL Kątownik magnetyczny spawalniczy
RUS Магнитная струбцина заварки

CZ Magnetický uhelník ke svařování
H Mágneses, hegesztő szögvas
RO Dispozitiv magnetic fixare pt. sudura
F Support magnétique de soudure

I Angolo magnetico da saldatura
E Escuadra magnética de soldadura
CN 焊接磁铁

DOUBLE
BLISTER



YATO	(kg)	mm	
YT-0863	11.5	82x120x13	6/48

YATO	(kg)	Ø (mm)	mm	
YT-0864	22.5	18	102x155x17	6/30
YT-0865	34.0	46	122x190x25	6/18

GB Magnetic welding holder
D Magnet-Werkstückhalter
PL Kątownik magnetyczny spawalniczy z wyłącznikiem
RUS Магнитная струбцина заварки с выключателем

CZ Magnetický uhelník ke svařování s vypínačem
H Mágneses, hegesztő szögvas, kapcsolóval
RO Dispozitiv magnetic fixare pt. sudura cu intreruptor
F Support magnétique de soudure

I Triangolo magnetico da saldatura con interruttore
E Escuadra magnética de soldadura, con interruptor
CN 焊接磁铁

DOUBLE
BLISTER

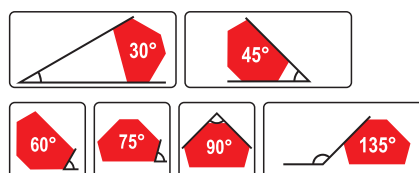

YATO	(kg)	mm	
YT-0866	11.5	64x95x14	6/24
YT-0867	34.0	111x136x24	6/18

GB Magnetic welding holder with switch
D Magnet-Werkstückhalter mit Schalter
PL Kątownik magnetyczny spawalniczy z wyłącznikiem
RUS Магнитный держатель заварки с выключателем

CZ Magnetický uhelník ke svařování s vypínačem
H Mágneses, hegesztő szögvas, kapcsolóval
RO Dispozitiv magnetic fixare pt. sudura cu intreruptor
F Support magnétique de soudure

I Triangolo magnetico da saldatura con interruttore
E Escuadra magnética de soldadura, con interruptor
CN 焊接磁铁















YATO	(kg)	mm	
YT-0870	13.5	107x160x26	6/24



10

Cutting tools Narzędzia tnące



Drills Wiertła		Thread repair sets & accessories Zestawy do naprawy gwintów i akcesoria.....	183
.....	171-178	Router bits Frezy do drewna	
Twist drill bits HSS & sets Wiertła do metalu HSS i zestawy.....	171	Diamond tools Narzędzia diamentowe	
Twist drill bits HSS-E Co & sets Wiertła do metalu HSS-E Co i zestawy.....	172	185-186
Twist drill bits HSS-TiN & sets Wiertła do metalu HSS-TiN i zestawy.....	173	Diamond blades for cutting construction materials Tarcze diamentowe do cięcia materiałów budowlanych.....	185
SDS masonry drill bits X-TIP Wiertła do betonu SDS, z grotem krzyżowym.....	174	Diamond blades for cutting concrete Tarcze diamentowe do cięcia betonu.....	185
SDS masonry drill bits Wiertła do betonu SDS.....	174	Diamond blades for cutting stone Tarcze diamentowe do cięcia kamienia.....	185
Masonry drill bits with cylindrical shank & sets Wiertła do betonu z uchwytem cylindrycznym i zestawy.....	175	Diamond blades for cutting ceramic tiles Tarcze diamentowe do cięcia płytek ceramicznych.....	186
Flat wood drill bits & sets Wiertła łopatkowe do drewna i zestawy.....	176	Diamond blades for cutting asphalt Tarcze diamentowe do cięcia asfaltu.....	186
Spur wood drill bits Wiertła do drewna spiralne.....	177	Diamond grinding cup wheels Diamentowe talerze szlifierskie do betonu i kamienia.....	186
Auger wood drill bits & sets Świdry do drewna i zestawy.....	177	Diamond core drill bits Diamentowe wiertła koronowe.....	186
Drills for ceramic tiles Wiertła do ceramiki i gresu.....	178	Tungsten carbide tipped tools Narzędzia z ostrzem z węgliku wolframu	
Adjustable hand reamers Rozwiertaki nastawne		187
.....	178	Tungsten carbide saws for wood Tarcze z węglikiem do drewna.....	187
Spot weld cutter sets Zestawy rozwiertaków do zgrzewów		Tungsten carbide saws for aluminium Tarcze z węglikiem do aluminium.....	187
.....	178	Cutting & grinding discs Tarcze do cięcia i szlifowania	
Combination edge setters & hole punch pliers Dziurkarko-felcarki		188-189
.....	178	Stainless steel cutting discs Tarcze do cięcia stali nierdzewnej.....	188
SDS Chisels Przecinaki i dłuta SDS		Metal cutting discs Tarcze do cięcia metalu.....	188
.....	179	Metal grinding discs Tarcze do szlifowania metalu.....	189
Hollow drill sets Wiertła koronowe do betonu		Stone cutting discs Tarcze do cięcia kamienia.....	189
.....	179	Stone grinding discs Tarcze do szlifowania kamienia.....	189
Bi-metal hole saws Otwornice bimetalowe		Shears Nożyce	
.....	180	190-194
Bi-metal hole saws Otwornice bimetalowe.....	180	Heavy duty cable cutters Nożyce do cięcia przewodów.....	190
Arbors for hole saws Uchwyty do otwornic bimetalowych.....	180	Tin snips Nożyce do blachy.....	190
Hole saw kits Zestawy otwornic bimetalowych.....	180	Steel strap cutters Nożyce do cięcia taśm stalowych.....	193
Taps & dies Narzędzia do gwintowania		Bolt cutters Nożyce do prętów.....	193
.....	181-183	Hydraulic cutters & accessories Nożyce z siłownikiem hydraulicznym i akcesoria.....	194
Hand taps & sets Gwintowniki i zestawy.....	181	Cable cutters Nożyce do kabli.....	194
Circular dies Narzynki.....	182	Multifunctional scissors Nożyce wielofunkcyjne.....	194
Tap wrenches & die holders Pokręta do gwintowników i narzynek.....	182		



Saws & blades			Profile gauges	
Piły i brzeszczoty			Wzorniki profili	210
.....		195-201	Punch sets	
Hand saws			Przebijaki do skóry	210
Piły do drewna		195	Cutters	
Bow saws			Obcinaki	211
Piły kabłąkowe		195	Window scrapers	
Blades			Skrobaki do szyb	213
Brzeszczoty		196	Scrapers	
Hacksaw frames			Cykliny metalowe	213
Piły do metalu		196	Steel files & sets	
Hacksaw frame blades			Pilniki do metalu i zestawy	214
Brzeszczoty do metalu		196	Needle file sets	
Jig saw blades			Zestawy pilników iglaków	215
Brzeszczoty do wyrzynarek		197	Diamond needle files & sets	
Accessories for multi-purpose oscillating tools			Pilniki iglaki diamentowe i zestawy	216
Akcesoria do wielofunkcyjnych narzędzi oscylacyjnych		199	Rasps & sets	
			Tarniki do drewna i zestawy	217
			Abrasive products	
Brushes, knives & files			Artykuły ścierne	
Szczotki, noże i pilniki			218-222
.....		202-217	Sand papers	
Wire brushes & sets			Papiery ścierne	218
Szczotki druciane i zestawy		202	Waterproof sand papers	
Cleaning pads for pipes			Papiery ścierne wodoodporne	219
Włókniny do czyszczenia rur		204	Abrasive clothes	
Cup brushes			Płótna ścierne	219
Szczotki tarczowe		205	No end abrasive bands	
Knives & blades			Taśmy ścierne bezkońcowe	220
Noże i ostrza		206	Flap discs	
Scissors			Ściernice listkowe	221
Nożyczki		209	Abrasive sheets and discs	
			Arkusze i krążki ścierne	222

GB Twist drill HSS
D Metallspiralbohrer HSS
PL Wiertło do metalu HSS

RUS Свёрло по металлу HSS
CZ Vrták na kov HSS
H Fúrószár fémhez HSS

RO Burghiu pt. metal HSS
F Foret métal HSS
I Punta per metallo HSS

E Broca para metal HSS
CN 轧制麻花钻



HSS
6542

DIN
338

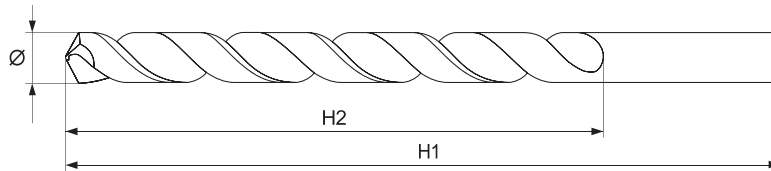

- application: industry
- for precise drilling in steels, cast steels, non-ferrous metals, plastics
- przeznaczenie: przemysł
- do precyzyjnych wierceń w stalach, żeliwach, metalach nieżelaznych, tworzywach sztucznych



YATO	Ø (mm)	H1 (mm)	H2 (mm)	R.P.M.max.	PCS packing:	
YT-4430	1.0	34	12	3800	10	80/320
YT-4431	1.5	43	20	3800	10	80/320
YT-4432	2.0	49	24	4000	10	80/320
YT-4433	2.5	57	30	3200	10	80/320
YT-4434	2.8	61	33	2800	10	80/320
YT-4435	3.0	61	33	2600	10	80/320
YT-4436	3.2	65	36	2500	10	80/320
YT-4437	3.5	70	39	2300	10	80/320
YT-4438	4.0	75	43	2000	10	80/320
YT-4439	4.2	75	43	1900	10	20/80
YT-4440	4.5	80	47	1800	10	20/80
YT-4441	4.8	86	52	1600	10	20/80
YT-4442	5.0	86	52	1600	10	20/80
YT-4443	5.2	86	52	1500	10	20/80
YT-4444	5.5	93	57	1500	10	20/80

YATO	Ø (mm)	H1 (mm)	H2 (mm)	R.P.M.max.	PCS packing:	
YT-4445	6.0	93	57	1300	10	20/80
YT-4446	6.5	101	63	1200	10	10/40
YT-4447	7.0	109	69	1100	10	10/40
YT-4448	7.5	109	69	1100	10	10/40
YT-4449	8.0	117	75	1000	10	10/40
YT-4450	8.5	117	75	900	5	10/40
YT-4451	9.0	125	81	900	5	10/40
YT-4452	9.5	125	81	800	5	10/40
YT-4453	10.0	133	87	800	5	10/40
YT-4454	10.5	133	87	800	3	10/40
YT-4455	11.0	142	94	700	3	10/40
YT-4456	12.0	151	101	700	3	10/40
YT-4457	12.5	151	101	600	3	10/40
YT-4458	13.0	151	101	600	3	10/40

GB Twist drill set

D Metallspiralbohrersatz

PL Komplet wiertel do metalu

RUS Набор сверл по металлу

CZ Souprava vrtáků na kov

H Fúrószárkészlet fémhez

RO Set de burghie pt. metal

F Set des forets métal HSS

I Set punte per metallo

E Broca para metal

CN 轧制麻花钻组套



HSS
6542

DIN
338

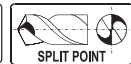

6
PCS

Ø mm
2-8



10
PCS

Ø mm
1-10



19
PCS

Ø mm
1-10



YATO	Ø (mm)	PCS
YT-4460	2; 3; 4; 5; 6; 8	15/60

YATO	Ø (mm)	PCS
YT-4461	1; 2; 3; 4; 5; 6; 7; 8; 9; 10	20/40

YATO	Ø (mm)	PCS
YT-4462	1.0; 1.5; 2.0; 2.5; 3.0; 3.5; 4.0; 4.5; 5.0; 5.5; 6.0; 6.5; 7.0; 7.5; 8.0; 8.5; 9.0; 9.5; 10.0	15/30

GB Twist drill HSS-COBALT
 D Metallspiralbohrer HSS-COBALT
 PL Wiertło do metalu HSS-COBALT
 RUS Сверло по металлу HSS-COBALT
 CZ Vrták na kov HSS-COBALT

H Fűrészár fémhez HSS-COBALT
 RO Burghiu pt. metal HSS-COBALT
 F Foret métal HSS-COBALT
 I Punte per metallo HSS-COBALT
 E Broca para metal HSS-COBALT
 CN 全磨制含钴麻花钻



DIN 338

HSS-E Co HS6-5-2-5 (PN-EN ISO 4957:2002(U))

Rm >900 N/mm²

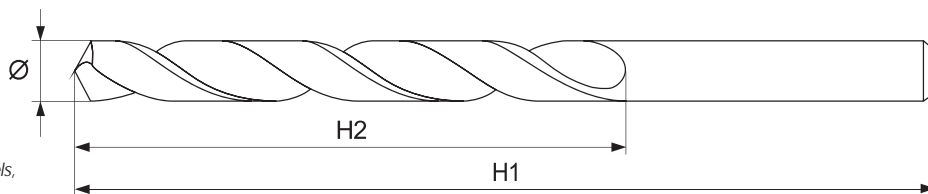

- application: industry
- for precise drilling in hard steels, non-ferrous metals, plastics, stainless steel and acid resistant steel
- resistant to high temperatures
- przeznaczenie: przemysł
- do precyzyjnych wierceń w trudnych materiałach, np. stalach szlachetnych, metalach kolorowych, tworzywach, stalach nierdzewnych i kwasoodpornych
- odporne na działanie wysokiej temperatury

BLISTER CARD



YATO	Ø (mm)	H1 (mm)	H2 (mm)	PCS packing
YT-4020	2.0	49	24	2 125/500
YT-4025	2.5	57	30	2 125/500
YT-4030	3.0	61	33	2 125/500
YT-4032	3.2	65	36	1 100/400
YT-4035	3.5	70	39	1 100/400
YT-4040	4.0	75	43	1 100/400
YT-4042	4.2	75	43	1 100/400
YT-4045	4.5	80	47	1 100/400

YATO	Ø (mm)	H1 (mm)	H2 (mm)	PCS packing
YT-4048	4.8	86	52	1 100/400
YT-4050	5.0	86	52	1 100/400
YT-4052	5.2	86	52	1 100/400
YT-4055	5.5	93	57	1 100/400
YT-4060	6.0	93	57	1 100/400
YT-4065	6.5	101	63	1 75/300
YT-4070	7.0	109	69	1 75/300
YT-4075	7.5	109	69	1 75/300

YATO	Ø (mm)	H1 (mm)	H2 (mm)	PCS packing
YT-4080	8.0	117	75	1 75/300
YT-4085	8.5	117	75	1 75/300
YT-4090	9.0	125	81	1 75/300
YT-4100	10.0	133	87	1 75/300
YT-4110	11.0	142	94	1 75/300
YT-4120	12.0	151	101	1 75/300
YT-4140	14.0	160	108	1 25/100
YT-4160	16.0	178	120	1 25/100

10

GB Twist drill set
 D Metallspiralbohrersatz
 PL Komplet wiertel do metalu
 RUS Набор сверл по металлу
 CZ Souprava vrtáků na kov
 H Fűrészárkészlet fémhez

RO Set de burghie pt. metal
 F Set des forets métal HSS
 I Set punte per metallo
 E Broca para metal
 CN 轧制麻花钻组套



DIN 338

HSS-E Co HS6-5-2-5 (PN-EN ISO 4957:2002(U))

Rm >900 N/mm²



6 PCS
 Ø mm 2-8
 PLASTIC HANGING BOX

10 PCS
 Ø mm 1-10
 PLASTIC HANGING BOX

19 PCS
 Ø mm 1-10
 PLASTIC HANGING BOX

25 PCS
 Ø mm 1-13
 PLASTIC HANGING BOX

YATO	Ø (mm)	PCS
YT-41602	2; 3; 4; 5; 6; 8	15/60

YATO	Ø (mm)	PCS
YT-41603	1; 2; 3; 4; 5; 6; 7; 8; 9; 10	20/40

YATO	Ø (mm)	PCS
YT-41604	1.0; 1.5; 2.0; 2.5; 3.0; 3.5; 4.0; 4.5; 5.0; 5.5; 6.0; 6.5; 7.0; 7.5; 8.0; 8.5; 9.0; 9.5; 10.0	15/30

YATO	Ø (mm)	PCS
YT-41605	1.0; 1.5; 2.0; 2.5; 3.0; 3.5; 4.0; 4.5; 5.0; 5.5; 6.0; 6.5; 7.0; 7.5; 8.0; 8.5; 9.0; 9.5; 10.0; 10.5; 11.0; 11.5; 12.0; 12.5; 13.0	10

GB Twist drill
D Metallspiralbohrer
PL Wiertło do metalu

RUS Сверло по металлу
CZ Vrták na kov
H Fúrószár fémhez

RO Burghiu pt. metal
F Foret métal
I Punte per metallo

E Broca para metal
CN 全磨制合钻麻花钻

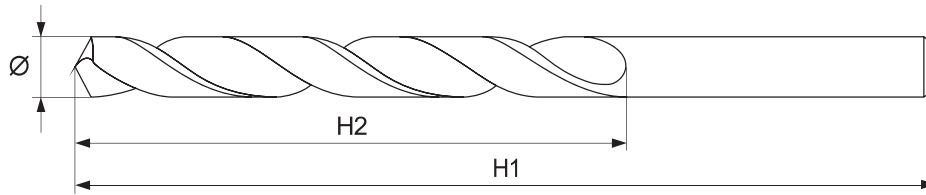

BLISTER CARD



YATO	Ø (mm)	H1 (mm)	H2 (mm)	PCS packing	
YT-44630	1.0	34	12	2	50/500
YT-44631	1.5	40	18	2	50/500
YT-44632	2.0	49	24	2	50/500
YT-44633	2.5	57	30	2	50/500
YT-44634	2.8	61	33	2	50/500
YT-44635	3.0	61	33	2	50/500
YT-44637	3.2	65	36	1	50/500
YT-44639	3.5	70	39	1	50/500
YT-44640	4.0	75	43	1	50/500
YT-44642	4.2	75	43	1	50/500

YATO	Ø (mm)	H1 (mm)	H2 (mm)	PCS packing	
YT-44643	4.5	80	47	1	50/500
YT-44645	4.8	86	52	1	50/500
YT-44650	5.0	86	52	1	50/500
YT-44652	5.2	86	52	1	50/500
YT-44653	5.5	93	57	1	50/500
YT-44654	6.0	93	57	1	50/500
YT-44655	6.5	101	63	1	50/250
YT-44656	7.0	109	69	1	50/250
YT-44657	7.5	109	69	1	50/250
YT-44658	8.0	117	75	1	50/250

YATO	Ø (mm)	H1 (mm)	H2 (mm)	PCS packing	
YT-44659	8.5	117	75	1	50/250
YT-44660	9.0	125	81	1	50/250
YT-44661	9.5	125	81	1	50/250
YT-44662	10.0	133	87	1	50/200
YT-44663	10.5	133	87	1	50/200
YT-44664	11.0	142	94	1	50/200
YT-44666	12.0	151	101	1	50/100
YT-44667	12.5	151	101	1	50/100
YT-44668	13.0	151	101	1	50/100

GB Twist drill set
D Metallspiralbohrersatz
PL Komplet wiertel do metalu

RUS Набор сверл по металлу
CZ Souprava vrtáků na kov
H Fúrószárkészlet fémhez

RO Set de burghie pt. metal
F Set des forets métal HSS
I Set punte per metallo

E Broca para metal
CN 轧制麻花钻组套

5
PCS



10



PLASTIC TUBE



YATO	Ø (mm)	
YT-44700	4; 5; 6; 8; 10	30/60

GB Twist drill set
D Metallspiralbohrersatz
PL Komplet wiertel do metalu
RUS Набор сверл по металлу

CZ Souprava vrtáků na kov
H Fúrószárkészlet fémhez
RO Set de burghie pt. metal
F Set des forets métal HSS

I Set punte per metallo
E Broca para metal
CN 轧制麻花钻组套



6
PCS

Ø mm
2-8

PLASTIC HANGING BOX

10
PCS

Ø mm
1-10

PLASTIC HANGING BOX

19
PCS

Ø mm
1-10

PLASTIC HANGING BOX

25
PCS

Ø mm
1-13

PLASTIC HANGING BOX

YATO	Ø (mm)	
YT-44673	2; 3; 4; 5; 6; 8	50/100

YATO	Ø (mm)	
YT-44674	1; 2; 3; 4; 5; 6; 7; 8; 9; 10	25/100

YATO	Ø (mm)	
YT-44675	1.0; 1.5; 2.0; 2.5; 3.0; 3.5; 4.0; 4.5; 5.0; 5.5; 6.0; 6.5; 7.0; 7.5; 8.0; 8.5; 9.0; 9.5; 10.0	6/30

YATO	Ø (mm)	
YT-44676	1.0; 1.5; 2.0; 2.5; 3.0; 3.5; 4.0; 4.5; 5.0; 5.5; 6.0; 6.5; 7.0; 7.5; 8.0; 8.5; 9.0; 9.5; 10.0; 10.5; 11.0; 11.5; 12.0; 12.5; 13.0	5/10

GB Masonry drill bit X-TIP
 D Betonspiralbohrer X-TIP
 PL Wiertło do betonu X-TIP
 RUS Сверло по бетону X-TIP
 CZ Vrták na beton X-TIP
 H Fűrészár betonhoz X-TIP

RO Burghiu pt. beton X-TIP
 F Foret béton à pointe en croix
 I Punta per cemento X-TIP
 E Broca para hormigón X-TIP
 CN 十字头电锤钻



SDS PLUS

X-TIP YG-11C

FOR REINFORCED CONCRETE DO BETONU ZERDZONEGO

DOUBLE SPIRAL PODWÓJNA SPIRALA

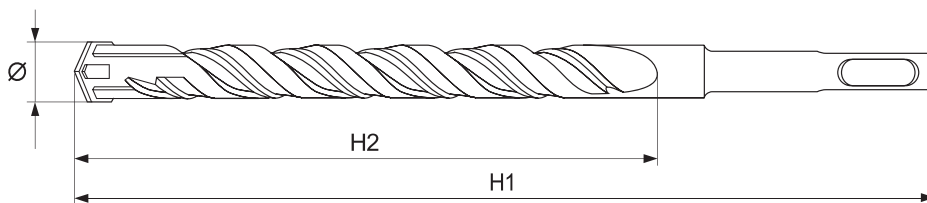

PLASTIC HANGER

YATO	Ø (mm)	H1 (mm)	H2 (mm)	PCS packing	
YT-4200	5	110	45	10	300
YT-4201	6	110	45	10	300
YT-4202	6	160	95	10	200
YT-4203	6	210	135	10	150
YT-4204	8	110	45	10	300
YT-4205	8	160	95	10	200
YT-4206	8	210	140	10	150
YT-4207	8	460	370	10	50
YT-4208	8	600	500	10	50
YT-4209	10	160	95	10	150
YT-4210	10	210	140	10	150

YATO	Ø (mm)	H1 (mm)	H2 (mm)	PCS packing	
YT-4211	10	300	220	10	100
YT-4212	10	460	370	10	50
YT-4213	10	600	500	10	50
YT-4214	12	160	95	10	150
YT-4215	12	260	185	10	100
YT-4216	12	460	360	10	50
YT-4217	12	600	490	10	40
YT-4218	14	260	180	10	80
YT-4219	14	460	360	10	40
YT-4220	16	200	125	10	60
YT-4221	16	460	360	10	20

YATO	Ø (mm)	H1 (mm)	H2 (mm)	PCS packing	
YT-4222	16	600	490	10	20
YT-4223	18	460	360	10	20
YT-4224	18	600	490	10	20
YT-4225	20	460	360	5	20
YT-4226	20	600	490	5	20
YT-4227	22	460	360	5	20
YT-4228	22	600	490	5	20
YT-4229	25	460	360	5	20
YT-4230	25	600	490	5	10

10

GB Masonry drill bit
 D Betonspiralbohrer
 PL Wiertło do betonu
 RUS Сверло по бетону

CZ Vrták na beton
 H Fűrészár betonhoz
 RO Burghiu pt. beton
 F Foret béton

I Punta per cemento
 E Broca para hormigón
 CN 建工钻



SDS PLUS

3 POINT TIP DK-30

DOUBLE SPIRAL PODWÓJNA SPIRALA

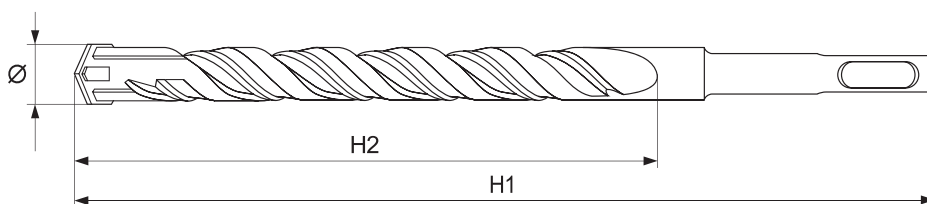

PLASTIC HANGER

YATO	Ø (mm)	H1 (mm)	H2 (mm)	PCS packing	
YT-4161	5	110	45	10	300
YT-4162	6	110	45	10	300
YT-4163	6	160	95	10	200
YT-4164	6	210	140	10	150
YT-4165	8	110	45	10	300
YT-4166	8	160	90	10	200
YT-4167	8	210	140	10	150
YT-4168	8	460	370	10	50
YT-4169	8	600	500	10	50
YT-4170	10	160	95	10	150
YT-4171	10	210	140	10	150

YATO	Ø (mm)	H1 (mm)	H2 (mm)	PCS packing	
YT-4172	10	300	220	10	100
YT-4173	10	460	370	10	50
YT-4174	10	600	500	10	50
YT-4175	12	160	85	10	150
YT-4176	12	260	180	10	100
YT-4177	12	460	360	10	50
YT-4178	12	600	490	10	40
YT-4179	14	260	180	10	80
YT-4180	14	460	360	10	40
YT-4181	16	200	125	10	60
YT-4182	16	300	220	10	50

YATO	Ø (mm)	H1 (mm)	H2 (mm)	PCS packing	
YT-4183	16	460	360	10	20
YT-4184	16	600	490	10	20
YT-4185	18	460	360	10	20
YT-4186	18	600	490	10	20
YT-4187	20	460	360	5	20
YT-4188	20	600	490	5	20
YT-4189	22	460	360	5	20
YT-4190	22	600	490	5	20
YT-4191	25	460	360	5	20
YT-4192	25	600	490	5	10

GB Masonry drill bit
D Betonspiralbohrer
PL Wiertło do betonu
RUS Сверло по бетону
CZ Vrták na beton
H Fúrészár betonhoz

RO Burghiu pt. beton
F Foret béton
I Punta per cemento
E Broca para hormigón
CN 建工钻

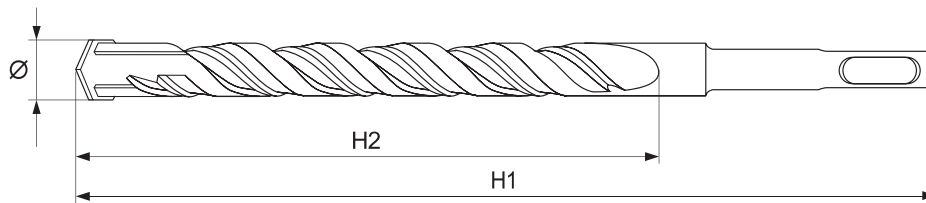

PLASTIC TUBE
& PLASTIC HANGER

- for windows assembly
- without necessity of using screw anchors
- do montażu okien
- bez użycia kołków rozporowych

YATO	Ø (mm)	H1 (mm)	H2 (mm)	PCS packing	
YT-41641	6.5	200	130	10	10/150
YT-41642	6.5	260	183	10	10/150

GB Masonry drill bit
D Betonspiralbohrer
PL Wiertło do betonu
RUS Сверло по бетону
CZ Vrták na beton
H Fúrészár betonhoz

RO Burghiu pt. beton
F Foret béton
I Punta per cemento
E Broca para hormigón
CN 建工钻

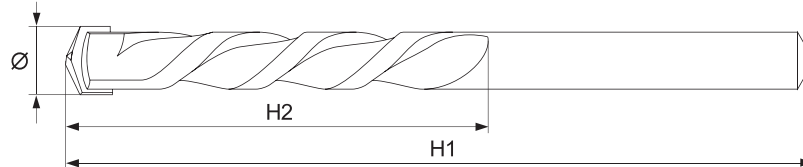
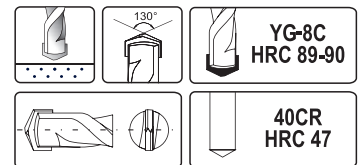

BLISTER
CARD

YATO	Ø (mm)	H1 (mm)	H2 (mm)	
YT-4361	4	70	35	100/400
YT-4362	5	90	50	100/400
YT-4363	6	100	60	100/400
YT-4364	6	150	100	100/400
YT-4367	7	100	60	75/300
YT-4369	8	120	80	75/300
YT-4370	8	200	140	50/150

YATO	Ø (mm)	H1 (mm)	H2 (mm)	
YT-4373	9	120	80	75/300
YT-4375	10	120	80	75/300
YT-4376	10	200	140	50/150
YT-4379	12	150	100	50/150
YT-4380	12	200	140	50/150
YT-4383	14	180	120	25/100
YT-4385	16	180	120	25/100

GB Masonry drill bit set
D Betonspiralbohrersatz
PL Komplet wiertel do betonu
RUS Сверла по бетону в наборе
CZ Souprava vrtáků do betonu
H Fúrészárkészlet betonhoz
RO Set de burghie pt. beton
F Set des forets béton
I Set punte per cemento
E Brocas para hormigón
CN 建工钻组套

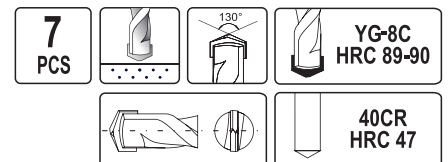

PLASTIC
HANGING BOX

YATO	Ø (mm)	
YT-4390	4; 5; 6; 8; 9; 10; 12	10/80

GB Flat wood drill bit
 D Schaufelbohrer
 PL Wiertło łopatkowe do drewna
 RUS Перовые сверло

CZ Plochý vrták
 H Homlokmarós fűrő
 RO Burghiu plate
 F Mèche à bois plate

I Punta per legno piatta
 E Broca de aletas
 CN 木工扁钻

DOUBLE BLISTER



1/4" (6.3mm)

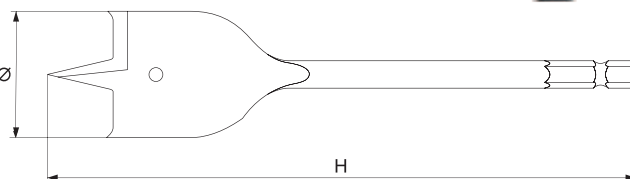

YATO	Ø (mm)	H (mm)	
YT-3236	6	152	50/400
YT-3237	8	152	50/400
YT-3238	10	152	50/300
YT-3239	12	152	50/300
YT-3240	13	152	50/300
YT-3241	14	152	50/300
YT-3242	16	152	50/300
YT-3243	18	152	50/300
YT-3244	20	152	50/300
YT-3245	22	152	50/300

YATO	Ø (mm)	H (mm)	
YT-3246	24	152	50/300
YT-3247	25	152	50/300
YT-3248	26	152	50/300
YT-3249	28	152	50/300
YT-3250	30	152	50/200
YT-3251	32	152	50/200
YT-3252	34	152	50/200
YT-3253	35	152	50/200
YT-3254	38	152	50/200
YT-3255	40	152	50/200

GB Extension for flat wood drill bits
 D Verlängerung für Schaufelbohrer
 PL Przedłużka do wiertel łopatkowych, bitów i wiertel

RUS Удлинитель для перовых сверл
 CZ Nástavec pro ploché vrtáky
 H Hosszabbító homlokmarós fáfűrőkhöz
 RO Prelungitor pt. burghie plate
 F Rallonge pour mèches à bois
 I Prolunga per punta fresatrice
 E Extensión para brocas de aletas
 CN 木工扁钻延长杆

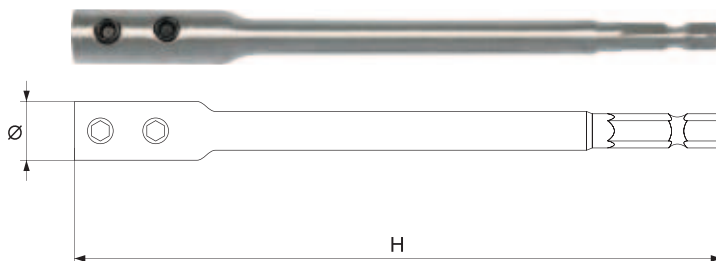

1/4" (6.3mm)

DOUBLE BLISTER

YATO	Ø (mm)	H (mm)	
YT-3256	12.2	150	60/120
YT-3257	13.5	300	30/60

GB Flat wood drill bit set
 D Schaufelbohrersatz
 PL Zestaw wiertel łopatkowych
 RUS Набор перовых сверл
 CZ Sada plochých vrtáků
 H Homlokmarós fáfűrő készlet

RO Set burghie plate
 F Set de mèche à bois
 I Set di punte per legno piatta
 E Juego de brocas de aletas
 CN 木工扁钻组套

6 PCS

1/4" (6.3mm)

GB Flat wood drill bit set
 D Schaufelbohrersatz
 PL Zestaw wiertel łopatkowych
 RUS Набор перовых сверл
 CZ Sada plochých vrtáků
 H Homlokmarós fáfűrő készlet

RO Set burghie plate
 F Set de mèche à bois
 I Set di punte per legno piatta
 E Juego de brocas de aletas
 CN 木工扁钻组套

8 PCS

1/4" (6.3mm)



POUCH

YATO	Ø (mm)	H (mm)	
YT-3258	10; 12; 16; 18; 20; 25	152	25/50



PLASTIC CASE & DOUBLE BLISTER

YATO	Ø (mm)	H (mm)	
YT-3259	12; 16; 18; 20; 22; 25; 28; 32	152	5/20

GB Spur wood drill bit
D Spiralbohrer für Holz
PL Wiertło do drewna spiralne

RUS Спиральное сверло по дереву
CZ Vrták do dřeva spirálový
H Csigafúró fához

RO Burghiu spirală pt. lemn
F Méches hélicoïdales à bois
I Punta per legno spirale

E Barrena para madera espiral
CN 木工钻

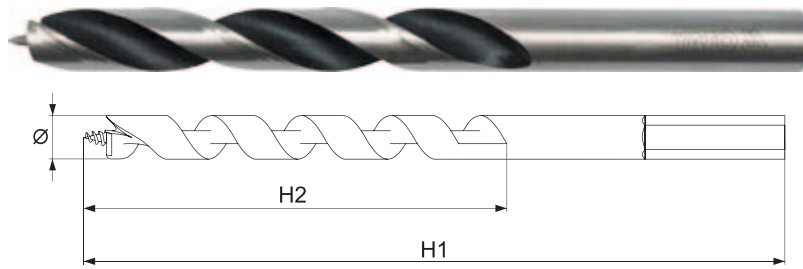

DOUBLE BLISTER

YATO	Ø (mm)	H1 (mm)	H2 (mm)	Box
YT-4350	3	60	35	30/300
YT-4351	4	75	44	30/300
YT-4352	5	85	52	30/300
YT-4353	6	90	57	30/300
YT-4354	7	100	67	30/300

YATO	Ø (mm)	H1 (mm)	H2 (mm)	Box
YT-4355	8	110	75	30/300
YT-4356	10	120	77	30/300
YT-4357	12	150	97	15/120
YT-4358	13	150	102	15/120
YT-4359	16	160	120	15/120

GB Auger wood drill bit
D Holzbohrer
PL Świder do drewna

RUS Бур по дереву
CZ Vrták do dřeva hadovitý
H Fafúró

RO Burghiu elicoidal pt. lemn
F Foret spirale à bois
I Punta a torciglione per legno

E Barrena para madera
CN 螺旋木工钻



13mm

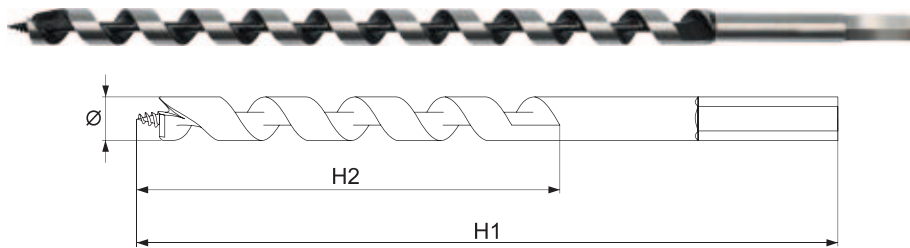

DOUBLE BLISTER

YATO	Ø (mm)	H1 (mm)	H2 (mm)	Box
YT-3261	6	191	121	60/360
YT-3262	8	191	121	70/280
YT-3263	8	400	310	60/120
YT-3264	10	191	121	50/200
YT-3265	10	400	310	50/100
YT-3266	12	191	121	50/150
YT-3267	12	400	310	20/60
YT-3268	13	191	121	50/100
YT-3269	13	400	310	20/60
YT-3270	14	191	121	50/100
YT-3271	14	400	310	20/60
YT-3272	16	191	121	50/100
YT-3273	16	400	310	20/40

YATO	Ø (mm)	H1 (mm)	H2 (mm)	Box
YT-3274	18	215	142	40/80
YT-3275	18	400	310	20/40
YT-3276	20	215	145	20/60
YT-3277	20	400	310	20/40
YT-3278	22	215	145	20/60
YT-3279	22	400	310	10/30
YT-3280	24	215	145	20/60
YT-3281	24	400	310	6/30
YT-3282	25	215	145	20/40
YT-3283	25	400	310	5/25
YT-3284	26	215	145	10/40
YT-3285	26	400	310	10/20
YT-3286	28	240	145	9/36

YATO	Ø (mm)	H1 (mm)	H2 (mm)	Box
YT-3287	28	400	310	5/20
YT-3288	30	240	170	10/30
YT-3289	30	400	310	5/10
YT-3290	32	240	170	5/25
YT-3291	32	400	310	5/15
YT-3292	35	240	170	5/20
YT-3293	35	400	310	5/10
YT-3294	36	240	170	10/20
YT-3295	36	400	310	5/10
YT-3296	38	240	170	5/15
YT-3297	40	240	170	5/15

GB Auger wood drill bit set
D Holzbohrersatz
PL Zestaw świderów do drewna
RUS Набор буров по дереву
CZ Sada hadovitých vrtáků do dřeva
H Fafúró készlet
RO Set de burghie elicoidale pt. lemn
F Set de forets spirales à bois
I Set di punte a torciglione
E Juego de barrenas para madera
CN 螺旋木工钻组套



WOOD CASE & COLOR BOX

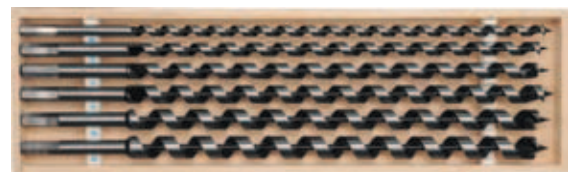

6 PCS	13mm	YATO	Ø (mm)	H (mm)	Box
		YT-3299	10; 12; 14; 16; 18; 20	460	8



6 PCS	13mm	YATO	Ø (mm)	H (mm)	Box
		YT-3298	10; 12; 14; 16; 18; 20	230	15

6 PCS	SDS PLUS	YATO	Ø (mm)	H (mm)	Box
		YT-3300	10; 12; 14; 16; 18; 20	200	20

GB Drill for ceramic tiles
 D Keramik und Fliesen Bohr
 PL Wiertło do ceramiki i gresu
 RUS Бурильные плитки и керамики
 CZ Vrtací tašek a keramických výrobků

H Fűrő cserép és kerámia
 RO Gresie de foraj si produse ceramice
 F Tuiles de forage et de la céramique

I Piastrelle e ceramiche trapano
 E Azulejos y cerámicas de perforación
 CN 玻璃钻

SLIDING CARD



YG6X
TUNGSTEN CARBIDE TP
OSTRZE Z WĘGLIKA
WOLFRAMU

HRA
90



YATO	Ø (mm)	
YT-3725	4	100/400
YT-3726	6	100/400

YATO	Ø (mm)	
YT-3727	8	100/400
YT-3728	10	50/200

GB Adjustable hand reamer
 D Verstellbare Reibahle
 PL Rozwiertak nastawny
 RUS Регулируемая развертка

CZ Nastavitelný výstružník
 H Állítható dörzsár
 RO Alezor reglabil
 F Alesoir à main réglable

I Alesatore regolabile
 E Escariador ajustable
 CN 可调式手用铰刀

PLASTIC TUBE



HSS
4241



YATO	working diameter / średnica robocza (mm)	L (mm)	arbor diameter / średnica trzpienia (mm)	
YT-28950	7.75-8.5	107	4.5	50/200
YT-28951	8.5-9.25	112	4.5	50/200
YT-28952	9.25-10	116	5.0	50/200
YT-28953	10-10.75	125	5.5	50/200
YT-28954	10.75-11.75	130	6.5	50/200
YT-28955	11.75-12.75	135	7.5	50/150
YT-28956	12.75-13.75	140	7.5	50/150
YT-28957	13.75-15.25	158	8.0	20/60
YT-28958	15.25-17	165	9.0	20/60

YATO	working diameter / średnica robocza (mm)	L (mm)	arbor diameter / średnica trzpienia (mm)	
YT-28959	17-19	175	10.0	20/60
YT-28960	19-21	180	11.5	20/60
YT-28961	21-23	193	13.5	20/60
YT-28962	23-26	210	15.4	4/20
YT-28963	26-29.5	245	17.0	4/20
YT-28964	29.5-33.5	270	19.0	4/12
YT-28965	33.5-38	310	21.0	2/10
YT-28966	38-44	345	24.0	2/10
YT-28967	44-54	400	30.0	5

GB Spot weld cutter & drill bit set
 D Schweißpunktbohrer Set Schweißpunktfräser
 PL Zestaw rozwiertaków do zgrzewów punktowych
 RUS Набор для высверливания точечной сварки
 CZ Sada na odvrtání bodových svárů
 H Hegesztőpont maró készlet

RO Set de freze pt. suduri in puncte
 F Jeu de fraises pour points de soudage
 I Set di alesatori per punti di saldatura
 E Juego de puntos de soldadura de la fresa
 CN 点焊刀

9
PCS

8mm

10mm

HSS

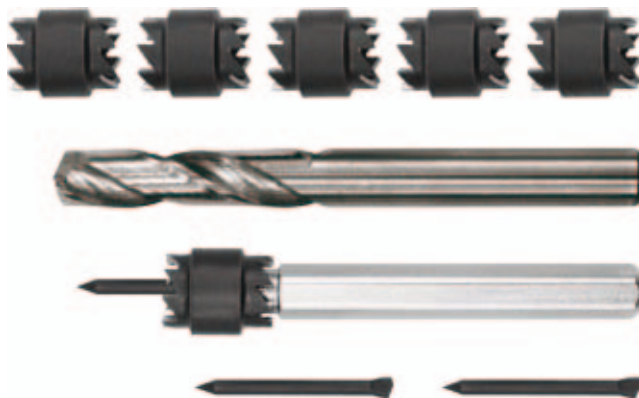

METAL BOX
& COLOR BOX



YATO	
YT-28920	10/60

GB Combination edge setter / hole punch pliers
 D Kombinierte Absetzzange Lochzange
 PL Dziurkarko-felcarka
 RUS Дырокол, кромкогиб
 CZ Falcovačka a děrovačka
 H Lyukasztó peremező fogó

RO Cleste pt. fasonat si gaurit tabla
 F Pince spéciale perforatrice carrosserie
 I Combinazione: bordo setter / pinza perforare
 E Solapadora y ponchadora manual
 CN 点焊刀

13 mm

5 mm

22 mm

20 mm



HANGING
COLOR BOX



YATO	
YT-21582	10



GB Point chisel SDS+ *RUS* Зубило SDS+ *RO* Punctator SDS+ *E* Cincel puntiagudo SDS+
D Spitzmeißel SDS+ *CZ* Sekáč špičák SDS+ *F* Perçoir SDS+ *CN* SDS尖齒
PL Przecinak SDS+ *H* Hegyes véső SDS+ *I* Scalpello SDS+

4x14
x250
mm **SDS PLUS** **CrV**



PLASTIC HANGER



YATO 	L (mm)	
YT-4720	250	6/48



GB Flat chisel SDS+ *RUS* Долото узкое SDS+ *RO* Punctator pt. adancit SDS+ *E* Cincel plano estrecho SDS+
D Flachmeißel SDS+ *CZ* Sekáč plochý SDS+ *F* Ciseau SDS+ *CN* SDS平齒
PL Dłuto wąskie SDS+ *H* Lapos véső SDS+ *I* Scalpello punto stretto SDS+

20x14
x250
mm **SDS PLUS** **CrV**



PLASTIC HANGER



YATO 	L (mm)	
YT-4721	250	6/48



GB Hollow chisel SDS+ *RUS* Бороздник SDS+ *RO* Punctator pt. adancit SDS+ *E* Cincel acanalado SDS+
D Nutenmeißel SDS+ *CZ* Sekáč drážkovací SDS+ *F* Burin à entailler SDS+ *CN* SDS空心齒
PL Bruzdownik SDS+ *H* Horonyvéső SDS+ *I* Calibro scalpello SDS+

22x18
x250
mm **SDS PLUS** **CrV**



PLASTIC HANGER



YATO 	L (mm)	
YT-4722	250	6/48



GB Flat chisel SDS+ *RUS* Долото плоское SDS+ *RO* Punctator tip dalta SDS+ *E* Cincel plano SDS+
D Spatmeißel SDS+ *CZ* Sekáč plochý SDS+ *F* Ciseau SDS+ *CN* SDS平齒
PL Dłuto płaskie SDS+ *H* Széles lapos véső SDS+ *I* Scalpello piatto SDS+

40x14
x250
mm **SDS PLUS** **CrV**



PLASTIC HANGER



YATO 	L (mm)	
YT-4723	250	6/48

GB Hollow drill set *CZ* Korunový vtrák na zeď *I* Punta a corona per calcestruzzo
D Bohrkrona *H* Koronafúró falhoz *E* Broca widia para muro
PL Wiertło koronowe do betonu *RO* Burghiu cu coroañă pt. beton *CN* 扩孔钻
RUS Сверла по бетону корончатые *F* Trépied à mur

COLOR BOX







 **TCT** **YG-11C** **Cr50**  **50mm** **M16**



HEX
12mm

SDS PLUS

YATO 	Ø (mm)	TCT	
YT-4400	65	6	24
YT-4401	80	8	20

YATO 	Ø (mm)	TCT	
YT-4402	65	6	24
YT-4403	80	8	20

- GB Bi-metal hole saw
 D Bimetall-Lochsäge
 PL Otwornica bimetalowa
 RUS Ножовка к отверстиям би-металлическая
 CZ Vrtací korunka bimetalová
 H Bi-metál koronafűrő
- RO Găurător bi-metalic
 F Scie-trépan bimétal
 I Foro sega utensile da taglio bi-metallo
 E Sierra de marquetería bi-metálica
 CN 双金属孔锯



- application: industry
- to drill holes in stainless steels, cast steels, aluminium, wood, plastics
- cutting depth: 40 mm
- przeznaczenie: przemysł
- do wycinania otworów w stalach nierdzewnych, żelazie, aluminium, drewnie, tworzywach sztucznych
- głębokość cięcia: 40 mm

YATO	Ø (mm)	thread / gwint	
YT-3303	19	1/2" (12.5 mm)	25/100
YT-3304	20	1/2" (12.5 mm)	25/100
YT-3306	22	1/2" (12.5 mm)	25/100
YT-3308	25	1/2" (12.5 mm)	25/100
YT-3311	29	1/2" (12.5 mm)	25/100
YT-3313	32	5/8" (16 mm)	25/100
YT-3315	35	5/8" (16 mm)	25/100
YT-3317	38	5/8" (16 mm)	25/100
YT-3318	40	5/8" (16 mm)	25/100
YT-3321	44	5/8" (16 mm)	25/100

YATO	Ø (mm)	thread / gwint	
YT-3322	46	5/8" (16 mm)	25/100
YT-3323	48	5/8" (16 mm)	25/100
YT-3324	51	5/8" (16 mm)	25/100
YT-3327	57	5/8" (16 mm)	25/50
YT-3329	60	5/8" (16 mm)	25/50
YT-3330	64	5/8" (16 mm)	25/50
YT-3332	67	5/8" (16 mm)	25/50
YT-3333	68	5/8" (16 mm)	25/50
YT-3334	70	5/8" (16 mm)	25/50
YT-3336	76	5/8" (16 mm)	25/50

YATO	Ø (mm)	thread / gwint	
YT-3338	83	5/8" (16 mm)	25/50
YT-3343	95	5/8" (16 mm)	25/50
YT-3345	102	5/8" (16 mm)	10/20
YT-3346	105	5/8" (16 mm)	10/20
YT-3349	114	5/8" (16 mm)	10/20
YT-3350	121	5/8" (16 mm)	10/20
YT-3351	127	5/8" (16 mm)	10/20
YT-3353	140	5/8" (16 mm)	10/20

- GB Arbor for hole saw
 D Haltering für Lochsägen
 PL Uchwyt do otwornic
 RUS Рукоятка к ножовке
 CZ Šroubový unášec pro vrtací korunky
- H Befogósár a koronafűrőhoz
 RO Dispozitiv de antrenare pt. găurător bi-metalic
 F Mandrin aux scies-trépan
- I Pergolato per sega
 E Mango para las sierras de marquetería
 CN 孔锯柄轴



YATO	SDS+ / HEX	
YT-3370	HEX 7/16" (11 mm)	25/100
YT-3373	SDS+	25/100



YATO	SDS+ / HEX	
YT-3371	HEX 7/16" (11 mm)	25/100



YATO	SDS+ / HEX	
YT-3372	HEX 7/16" (11 mm)	25/50
YT-3374	SDS+	25/50

- GB Pilot drill
 D Pilotbohrer
 PL Wiertło pilot
 RUS Сверло пилот
 CZ Středící vrták
 H Központfűrő
- RO Burghiu pilot
 F Foret - pilot
 I Punta pilota
 E Broca piloto
 CN 导向钻



YATO	Ø (mm)	H (mm)	
YT-3376	6.0	75	25/100

YATO	Ø (mm)	H (mm)	
YT-3377	6.0	100	25/100

- GB Electrician's hole saw kit
 D Lochsägensatz für Elektriker
 PL Zestaw otwornic dla elektryków
 RUS Набор ножовок к отверстиям для электриков
 CZ Sada vrtacích korunek pro elektrikáře
 H Koronafűrő készlet villanyszerelőknék
- RO Set de găuritori pt. electricieni
 F Set de scies trépan aux électriciens
 I Set universale a tazza fresa con strumenti
 E Juego de sierras de marquetería para electricistas
 CN 双金属开孔器组套



BMC & COLOR SLEEVE

YATO	Ø (mm)	
YT-3380	22; 29; 35; 44; 67; 73	10

- GB Combination hole saw kit
 D Universal-Lochsägensatz
 PL Uniwersalny zestaw otwornic
 RUS Универсальный набор ножовок к отверстиям
 CZ Univerzální sada vrtacích korunek
 H Univerzális koronafűrő készlet
- RO Set univesal de găuritori
 F Set de scies trépan universelles
 I Set universale a tazza fresa con strumenti
 E Juego universal de sierras de marquetería
 CN 双金属开孔器组套

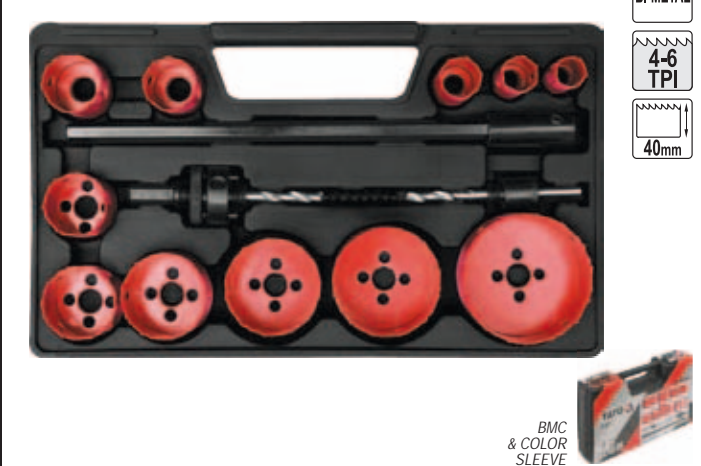

BMC & COLOR SLEEVE

YATO	Ø (mm)	
YT-3381	19; 22; 25; 32; 35; 38; 44; 51; 57; 64; 76	5

- GB Hand tap
D Handgewindebohrer
PL Gwintownik ręczny
RUS Ручной метчик
CZ Závětníky
H Menetfűró
- RO Tarozii
F Taraud à main
I Maschi filettatura a mano
E Machos de rosca
CN 三件套手用丝锥



SLIDING CARD



3
PCS

DIN
352

HSS
M2

3-STAGE
TAPPING
GWINTOWANIE
3-STOPNIOWE

METRIC
COARSE
GWINT METRYCZNY
GRUBOZWOJNY

YATO	size x pitch rozmiar x skok gwintu	thread length (mm) długość gwintu (mm)	L (mm)	shank diameter (mm) średnica trzonu (mm)	PCS packing:	weight (g) waga (g)	
YT-2930	M3x0.5	11	40	3.5	3	25	100/400
YT-2931	M4x0.7	13	45	4.5	3	35	50/200
YT-2932	M5x0.8	16	50	6.0	3	45	60/240
YT-2933	M6x1.0	19	50	6.0	3	45	60/240
YT-2934	M7x1.0	19	50	6.0	3	55	75/300
YT-2935	M8x1.25	22	56	6.0	3	60	50/200
YT-2937	M10x1.5	24	70	7.0	3	85	50/200

YATO	size x pitch rozmiar x skok gwintu	thread length (mm) długość gwintu (mm)	L (mm)	shank diameter (mm) średnica trzonu (mm)	PCS packing:	weight (g) waga (g)	
YT-2939	M12x1.75	29	75	9.0	3	125	50/200
YT-2940	M14x2.0	30	80	10.5	3	200	20/80
YT-2941	M16x2.0	32	80	11.0	3	235	20/80
YT-2942	M18x2.5	40	95	12.0	3	345	20/80
YT-2943	M20x2.5	40	95	14.0	3	445	10/40
YT-2926	M22x2.5	40	100	18.0	3	600	10/40
YT-2927	M24x3.0	50	110	18.0	3	700	15/30

- GB Machine tap
D Maschinengewindebohrer
PL Gwintownik maszynowy
RUS Машинный метчик
CZ Strojní závětník
H Gépi menetfűró
- RO Tarod de mașină
F Taraud machine
I Maschi filettatura
E Macho mecanico
CN 机用丝锥

DIN
371M

HSS
M2

1-STAGE
TAPPING
GWINTOWANIE
1-STOPNIOWE

METRIC
COARSE
GWINT METRYCZNY
GRUBOZWOJNY



SLIDING CARD



YATO	size x pitch rozmiar x skok gwintu	thread length (mm) długość gwintu (mm)	L (mm)	shank diameter (mm) średnica trzonu (mm)	weight (g) waga (g)	
YT-2950	M3x0.5	11	56	3.5	15	100/400
YT-2951	M4x0.7	13	63	4.5	20	100/400
YT-2952	M5x0.8	16	70	6.0	25	60/240
YT-2953	M6x1.0	19	80	6.0	30	50/200
YT-2954	M7x1.0	19	80	7.1	35	30/120
YT-2955	M8x1.25	22	90	8.0	45	50/200
YT-2956	M10x1.5	24	100	10.0	65	50/200

- GB Machine tap
D Maschinengewindebohrer
PL Gwintownik maszynowy
RUS Машинный метчик
CZ Strojní závětník
H Gépi menetfűró
- RO Tarod de mașină
F Taraud machine
I Maschi filettatura
E Macho mecanico
CN 机用丝锥

DIN
376

HSS
M2

1-STAGE
TAPPING
GWINTOWANIE
1-STOPNIOWE

METRIC
COARSE
GWINT METRYCZNY
GRUBOZWOJNY



SLIDING CARD



YATO	size x pitch rozmiar x skok gwintu	thread length (mm) długość gwintu (mm)	L (mm)	shank diameter (mm) średnica trzonu (mm)	weight (g) waga (g)	
YT-2944	M12x1.75	29	110	9.0	70	25/100
YT-2945	M14x2.0	30	110	11.0	110	25/100
YT-2946	M16x2.0	32	110	12.0	120	25/100
YT-2947	M18x2.5	34	125	14.0	200	25/100
YT-2948	M20x2.5	34	140	16.0	260	25/100
YT-2949	M22x2.5	34	140	18.0	340	20/80
YT-2957	M24x3.0	38	160	18.0	400	15/60
YT-2958	M27x3.0	38	160	20.0	500	15/60
YT-2959	M30x3.5	45	180	22.0	700	15/60

- GB Taps and dies set
D Gewindefschneidwerkzeug-Satz
PL Zestaw narzędzi i gwintowników
RUS Набор плашек и метчиков
CZ Souprava závětníků
a kruhových závitových čelistí
H Menetfűró és menetvágó készlet
RO Set de tarozii și filiere
F Set de filières et tarauds
I Set di filiera a maschi
E Juego de machos de rosca y cojinetes
CN 丝锥板牙组套

METAL CASE
& COLOR BOX



HSS



44
PCS

DIN223
DIN225
DIN338
DIN352
DIN1814



YATO	size / rozmiar	
YT-2978	M3; M4; M5; M6; M8; M10; M12	4



32
PCS

DIN223
DIN352

YATO	size / rozmiar	
YT-2975	M3; M4; M5; M6; M8; M10; M12	10



56
PCS

DIN223
DIN225
DIN352
DIN1814

YATO	size / rozmiar	
YT-2979	M3; M4; M5; M6; M8; M10; M12; M14; M16; M18; M20	2

- GB Taps set
- D Gewinbeschneidwerkzeug-Satz
- PL Zestaw gwintowników
- RUS Набор метчиков
- CZ Souprava závitníků
- H Menetfúró készlet
- RO Set de tarozi
- F Set de tarauds
- I Set di filettature
- E Juego de machos de roscar
- CN 丝锥组套



METAL CASE & COLOR BOX

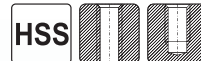

21 PCS

DIN 352

29 PCS

DIN338
DIN352
DIN1814



YATO	size / rozmiar	
YT-2976	M3; M4; M5; M6; M8; M10; M12	20

YATO	size / rozmiar	
YT-2977	M3; M4; M5; M6; M8; M10; M12	12

- GB Circular die
- D Schneideisen
- PL Narzynka
- RUS Плашка
- CZ Kruhová závitová čelist
- H Menetvágó
- RO Filieră
- F Filière
- I Filiere tonde
- E Cojinete de roscar
- CN 圆板牙



10

SLIDING CARD



YATO	size x pitch rozmiar x skok gwintu	outside diameter (mm) średnica zewnętrzna (mm)	thickness (mm) grubość (mm)	weight (g) waga (g)	
YT-2961	M4x0.7	20	5	20	125/500
YT-2962	M5x0.8	20	7	20	100/400
YT-2963	M6x1.0	20	7	20	100/400
YT-2964	M7x1.0	25	9	35	100/200
YT-2965	M8x1.25	25	9	35	100/400
YT-2967	M10x1.5	30	11	50	70/280
YT-2969	M12x1.75	38	14	90	60/240
YT-2970	M14x2.0	38	14	95	63/252

YATO	size x pitch rozmiar x skok gwintu	outside diameter (mm) średnica zewnętrzna (mm)	thickness (mm) grubość (mm)	weight (g) waga (g)	
YT-2971	M16x2.0	45	18	160	50/200
YT-2972	M18x2.5	45	18	160	50/200
YT-2973	M20x2.5	45	18	150	50/200
YT-2960	M22x2.5	55	22	300	20/80
YT-2966	M24x3.0	55	22	300	20/80
YT-2968	M27x3.0	65	25	400	15/60
YT-2974	M30x3.5	65	25	400	15/60

- GB T-handle tap wrench
- D Werkzeughalter für Gewinde
- PL Pokrętko typu „T” do gwintowników
- RUS Рукоятка типа „Т” к гаечному ключу
- CZ Vratidlo na závitníky typ „T”
- H Menetfúró befogó T-nyelű
- RO Port tarod cu maner
- F Porte-taraud type „T”
- I Chiave giramaschio tipo „T” per maschi
- E Llave giramachos „T”
- CN 丝锥铰手



SLIDING CARD

YATO	size / rozmiar	L (mm)	
YT-2986	M3-M8	70	20/80
YT-2987	M5-M10	80	20/80
YT-2988	M6-M12	90	20/80

- GB Ratchet tap wrench
- D Werkzeughalter
- PL Grzechołka do gwintownika
- RUS Трещетка для метчика
- CZ Řečtačka na závitník
- H Racsnis hajtószár menetfúróhoz
- RO Port tarod
- F Porte-taraud à cliquet
- I Chiave giramaschi a cricchetto
- E Carraca para macho de roscar
- CN 棘轮丝锥铰手



SLIDING CARD

YATO	size / rozmiar	L (mm)	
YT-2989	M3-M10	85	20/80
YT-2997	M3-M10	250	20/80
YT-2990	M5-M12	100	20/80
YT-2991	M5-M12	300	20/40

- GB Die handle
- D Schneideisenhalter
- PL Oprawa do narzynek
- RUS Плашкодержатель
- CZ Závitová objímka
- H Menetvágó tartó
- RO Portfilieră
- F Porte-filière
- I Porta filiere
- E Portacojinete
- CN 板牙铰手



SLIDING CARD



YATO	size / rozmiar	Ø (mm)	L (mm)	
YT-2980	M3-M4	20x5	200	25/100
YT-2981	M4.5-M6	20x7	200	25/100
YT-2982	M7-M9	25x9	224	25/100
YT-2983	M10-M11	30x11	280	25/50
YT-2984	M12-M14	38x14	315	15/30
YT-2985	M16-M20	45x18	450	10/20

- GB Tap wrench
- D Werkzeughalter für Gewinde
- PL Pokrętko do gwintowników
- RUS Вороток для метчиков
- CZ Ovládací kolečko na závitník
- H Hajtószár menetfúróhoz
- RO Cheie (mâner) pt. tarod
- F Porte-taraud
- I Manopola per il maschio
- E Llave giramachos
- CN 一型丝锥铰手



SLIDING CARD



YATO	size / rozmiar	L (mm)	
YT-2995	M1-M8	125	50/200
YT-2996	M3-M10	180	25/100
YT-2992	M3-M12	200	25/100
YT-2993	M4-M12	280	25/100
YT-2994	M5-M20	375	20/40

- GB Thread repair set
D Reparatursatz für Gewinde
PL Zestaw do naprawy gwintów
RUS Набор для ремонта резьбы
CZ Souprava na opravu závitů
H Menetjavító készlet
RO Set pt. reparare filete
- F Set d'helicoils
I Kit di riparazione per filettature
E Juego para reparar roscas
CN 螺纹修复组套





HSS
4341

STAINLESS
STEEL
STAL
NIEOŻEWNA

METAL BOX
& COLOR BOX





88
PCS

YATO 	size / rozmiar	
YT-1769	M6 x 1.0 x 10.8 mm	5/10
	M8 x 1.25 x 10.8 mm	
	M10 x 1.5 x 13.5 mm	



131
PCS

YATO 	size / rozmiar	
YT-1763	M5 x 0.8 x 6.7 mm	5/10
	M6 x 1.0 x 10.8 mm	
	M8 x 1.25 x 10.8 mm	
	M10 x 1.5 x 13.5 mm	
	M12 x 1.75 x 16.3 mm	



- GB Wire threads
D Spiraleinlagen für Gewindereparatur
PL Wkłady spiralne do naprawy gwintów
RUS Метчики и сверла для ремонта резьбы
CZ Spirálové vložky na opravu závitů
H Menetjavító betétek
RO Insertii spirală pt. reparare filete
F Helicoil
I Inserti a spirale per riparazione
E Elementos espirales para reparar roscas
CN 螺纹修复组套

for / dla: YT-1763, YT-1769

STAINLESS
STEEL
STAL
NIEOŻEWNA



POLYBAG
WITH
HEADER

YATO 	size / rozmiar	PCS packing	
YT-1764	M5 x 0.8 x 6.7 mm	20	50/250
YT-1765	M6 x 1.0 x 10.8 mm	20	50/250
YT-1766	M8 x 1.25 x 10.8 mm	20	50/200
YT-1767	M10 x 1.5 x 13.5 mm	15	25/100
YT-1768	M12 x 1.75 x 16.3 mm	10	25/100

- GB Router bit set
- D Oberfräsersatz
- PL Zestaw frezów do drewna
- RUS Набор фрез по дереву
- CZ Souprava frézů do dřeva
- H Medtjö frez kompletas
- RO Set de freze pt. lemn
- F Fraises pour le bois
- I Set di frese per legno
- E Juego de frezas para madera
- CN 木工铣刀组套









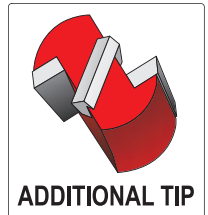















ALUMINIUM CASE & COLOR SLEEVE



 ±0.08 mm  YG6X  Ø8 mm



Router bit parameter												
Shank diameter [mm]	8	8	8	8	8	8	8	8	8	8	8	
Length [mm]	42.0	47.0	47.0	43.5	50.0	51.5	51.0	52.0	58.0	51.5	58.0	56.5
Router bit diameter [mm]	12.7	12.7	9.5	12.7	12.7	9.5	12.7	16.0	6.35	6.35	9.5	12.7
Cutting edge length [mm]	12.7	14.8	11.6	13.0	12.5	20.0	20.0	9.5	19.5	20.0	24.5	25.0
Curvature radius [mm]	-	-	-	-	-	4.75	6.35	-	-	-	-	-
Bearing diameter [mm]	-	-	-	-	-	-	-	12.7	-	-	-	-
Angle [°]	-	15	10	-	45	-	-	15	-	-	-	-















Router bit parameter												
Shank diameter [mm]	8	8	8	8	8	8	8	8	8	8	8	
Length [mm]	52.0	65.0	51.0	51.5	53.5	57.5	50.5	53.5	52.0	55.0	50.0	54.0
Router bit diameter [mm]	19.0	12.7	19.0	22.0	26.0	32.0	22.0	28.5	27.0	30.0	32.0	32.0
Cutting edge length [mm]	20.4	25.0	9.5	10.0	11.5	16.5	9.72	13.5	12.3	14.0	6.35	12.7
Curvature radius [mm]	-	-	3.2	4.76	6.35	9.5	6.35	9.5	4.0	-	-	-
Bearing diameter [mm]	-	12.7	-	12.7	12.7	12.7	9.5	9.5	9.5	12.7	12.7	12.7
Angle [°]	-	-	-	-	-	-	-	-	-	45	-	-















24 PCS

YATO 

YT-6801  10



Router bit parameter																		
Shank diameter [mm]	8	8	8	8	8	8	8	8	8	8	8	8	8	8	8			
Length [mm]	43.0	38.0	38.0	50.5	42.0	43.5	51.5	49.5	51.5	58.0	58.5	56.5	52.0	58.0	53.5	66.0	53.0	65.0
Router bit diameter [mm]	6.35	12.7	12.7	12.7	12.7	12.7	14.3	3.175	6.35	9.5	12.7	12.7	19.0	6.35	9.5	9.5	12.7	12.7
Cutting edge length [mm]	6.0	9.5	9.5	18.0	12.7	13.0	12.3	13.0	20.0	24.5	20.3	25.0	20.4	19.5	15.0	26.0	15.0	25.0
Curvature radius [mm]	3.175	6.35	-	6.35	-	-	-	-	-	-	-	-	-	-	-	-	-	-
Bearing diameter [mm]	-	-	-	-	-	-	-	-	-	-	-	-	-	-	9.5	9.5	12.7	12.7
Angle [°]	-	-	45	-	-	10	14	-	-	-	-	-	-	-	-	-	-	-

Router bit parameter																		
Shank diameter [mm]	8	8	8	8	8	8	8	8	8	8	8	8	8	8	8			
Length [mm]	65.5	55.0	51.0	55.0	50.0	52.5	54.0	55.5	60.0	60.0	56.0	60.0	52.5	58.0	53.5	57.5	61.0	-
Router bit diameter [mm]	19.0	30.0	26.0	32.0	32.0	32.0	32.0	32.0	32.0	38.0	32.0	38.0	26.0	38.0	26.0	32.0	38.0	-
Cutting edge length [mm]	26.0	14.0	9.7	13.3	6.35	8.0	9.5	15.0	18.5	20.0	16.0	19.0	12.5	17.8	11.5	16.5	20.8	-
Curvature radius [mm]	-	-	6.35	9.5	-	-	-	8.0	4.76	12.7	4.76	6.35	3.175	6.35	6.35	9.5	12.7	-
Bearing diameter [mm]	19.0	12.7	12.7	12.7	12.7	12.7	12.7	9.5	12.7	9.5	9.5	9.5	9.5	9.5	12.7	12.7	12.7	-
Angle [°]	-	45	-	-	-	-	-	-	-	-	-	-	-	-	-	-	-	-

35 PCS

YATO 

YT-6803  10

GB Diamond blade
D Diamant-Trennscheibe
PL Tarcza diamentowa
RUS Отрезной алмазный диск
CZ Diamantový kotouč
H Gyémántkorong

RO Disc cu diamant
F Disque diamant
I Disco diamantato
E Disco de diamante
CN 金刚石切片

DOUBLE
BLISTER

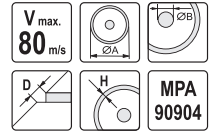

- application: concrete, brick, calcium-silicate brick, tile, masonry, stone
- przeznaczenie: beton utwardzony, cegła, cegła silikatowa, granit, mur, kamień

- application: ceramic, gres, glaze, glass, porcelain
- przeznaczenie: płytki ceramiczne, gres, glazura, płytki kamienne, szkło, porcelana

- application: concrete, reinforced concrete, brick, tile, masonry, stone, sandstone
- przeznaczenie: beton utwardzony, beton zbrojony, cegła, granit, mur, kamień, piaskowiec

YATO	∅A (mm)	∅B (mm)	R.P.M.max.	D (mm)	H (mm)	
YT-6002	115	22.2	12000	2.1	8.0	20/200
YT-6003	125	22.2	11000	2.2	8.0	20/160
YT-6004	180	22.2	8000	2.5	8.0	15/60
YT-6005	230	22.2	6500	2.7	8.0	10/40

YATO	∅A (mm)	∅B (mm)	R.P.M.max.	D (mm)	H (mm)	
YT-6012	115	22.2	12000	2.1	5.3	20/200
YT-6013	125	22.2	11000	2.2	5.3	20/160
YT-6014	180	22.2	8000	2.5	5.3	15/60
YT-6015	230	22.2	6500	2.7	5.3	10/40
YT-6016	180	25.4	8000	2.2	5.3	15/60
YT-6017	200	25.4	8000	2.2	5.3	10/40

YATO	∅A (mm)	∅B (mm)	R.P.M.max.	D (mm)	H (mm)	
YT-6022	115	22.2	12000	2.4	8.0	20/200
YT-6023	125	22.2	11000	2.6	8.0	20/160
YT-6024	180	22.2	8000	2.8	8.0	15/60
YT-6025	230	22.2	6500	3.1	8.0	10/40

GB Diamond blade
D Diamant-Trennscheibe
PL Tarcza diamentowa
RUS Отрезной алмазный диск
CZ Diamantový kotouč
H Gyémántkorong

RO Disc cu diamant
F Disque diamant
I Disco diamantato
E Disco de diamante
CN 金刚石切片



DOUBLE BLISTER



PAPER ENVELOPE



- application: concrete, reinforced concrete, clinker, brick, calcium-silicate brick
- przeznaczenie: beton utwardzony, beton zbrojony, klinkier, cegła, cegła silikatowa

- application: concrete, reinforced concrete, clinker, brick, calcium-silicate brick
- przeznaczenie: beton utwardzony, beton zbrojony, klinkier, cegła, cegła silikatowa

YATO	∅A (mm)	∅B (mm)	R.P.M.max.	D (mm)	H (mm)	
YT-5953	300	25.4	5100	3.0	10.0	10
YT-5954	350	25.4	4300	3.2	10.0	5
YT-5955	400	25.4	3800	3.6	10.0	5

YATO	∅A (mm)	∅B (mm)	R.P.M.max.	D (mm)	H (mm)	
YT-5956	450	25.4	3400	3.8	10.0	5



DOUBLE BLISTER



PAPER ENVELOPE



- application: natural stone, artificial stone, calcium-silicate brick
- przeznaczenie: kamień naturalny, kamień sztuczny, cegła silikatowa

- application: natural stone, artificial stone, calcium-silicate brick
- przeznaczenie: kamień naturalny, kamień sztuczny, cegła silikatowa

YATO	∅A (mm)	∅B (mm)	R.P.M.max.	D (mm)	H (mm)	
YT-5965	400	25.4	3800	3.6	10.0	5

YATO	∅A (mm)	∅B (mm)	R.P.M.max.	D (mm)	H (mm)	
YT-5966	450	25.4	3400	3.8	10.0	5

- GB Diamond blade
 - D Diamant-Trennscheibe
 - PL Tarcza diamentowa
 - RUS Отрезной алмазный диск
 - CZ Diamantový kotouč
 - H Gyémántkorong
 - RO Disc cu diamant
- F Disque diamant
 - I Disco diamantato
 - E Disco de diamante
 - CN 金刚石切片

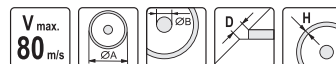

- application: ceramic tiles, thin natural stone tiles, glaze, glass, porcelain
- przeznaczenie: płytki ceramiczne, cienkie płytki z naturalnego kamienia, glazura, szkło, porcelana

DOUBLE BLISTER



DOUBLE BLISTER



- application: asphalt, checker brick, silicate, chamotte, fresh concrete materials, other ceramic building materials
- przeznaczenie: asfalt, cegła „kratówka”, silikaty, szamot, świeży beton, inne ściernalne materiały budowlane

YATO	ØA (mm)	ØB (mm)	R.P.M.max.	D (mm)	H (mm)	Box
YT-5973	250	25.4	6100	1.8	10.0	20
YT-5974	300	25.4	5100	2.1	10.0	10
YT-5975	350	25.4	4300	2.4	10.0	5

YATO	ØA (mm)	ØB (mm)	R.P.M.max.	D (mm)	H (mm)	Box
YT-5992	350	25.4	4300	3.2	10.0	5

10



- application: asphalt, checker brick, silicate, chamotte, fresh concrete materials, other ceramic building materials
- przeznaczenie: asfalt, cegła „kratówka”, silikaty, szamot, świeży beton, inne ściernalne materiały budowlane

PAPER ENVELOPE

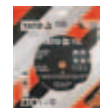

YATO	ØA (mm)	ØB (mm)	R.P.M.max.	D (mm)	H (mm)	Box
YT-5994	450	25.4	3400	3.6	10.0	5

- GB Diamond grinding cup wheel
- D Diamant Schleiftopf Schleifteller
- PL Tarcza szlifierska diamentowa
- RUS Алмазный диск шлифовальный
- CZ Diamantový brusný kotouč
- H Gyémánt csiszoló kúpos
- RO Disc cupa diamantat pt. slefuit
- F Disque diamant
- I Disco diamantato
- E Disco diamante de lijar
- CN 金刚石杯型磨轮

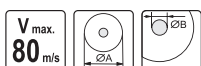

HANGING COLOR BOX



- application: concrete, clinkier, natural stone, screed
- przeznaczenie: beton utwardzony, klinkier, kamień naturalny, jastrych

YATO	ØA (mm)	ØB (mm)	R.P.M.max.	segment size (mm)	Box
YT-6030	125	22.2	12200	5.0x7.5	20
YT-6032	125	22.2	12200	4.5x20.0	20

- GB Diamond core bit drilling holes for sockets
- D Diamant-Bohrkrone
- PL Diamentowe wiertło koronowe
- RUS Алмазное сверло корончатое
- CZ Diamantový korunkový vrták
- H Gyémánt fúrókorona
- RO Carota diamantata pt. beton
- F Trépiéd à mur diamantées
- I Corona diamantata per calcestruzzo
- E Corona con broca diamante
- CN 金刚石薄壁钻



COLOR BOX



- application: concrete, calcium-silicate brick, porous ceramics
- przeznaczenie: beton utwardzony, cegła silikatowa, ceramika poryzowana

YATO	Ø (mm)	R.P.M.max.	segment size (mm)	Box
YT-6045	68	1030	3.5x10x24	24
YT-6046	82	850	3.5x10x24	20

- GB TCT circular saw blade for wood
D Kreissägeblatt HM-Bestückt
PL Piła tarczowa do drewna z węglikiem wolframu
RUS Диск пильный с карбидом вольфрама
CZ Kotoučová pila na dřevo z karbidem wolframu
H Wolframkarbidos körfűrész fához
RO Ferăstrău circular cu dinți din wolfram pt. lemn
F Lame de scie circulaire carburé
I Lama troncatrice taglio legno
E Disco de sierra con carbono de tungsteno
CN 木工锯片

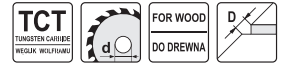

- application: for cutting wood and plastics
- przeznaczenie: do cięcia drewna, płyt drewnopochodnych, tworzyw sztucznych

DOUBLE BLISTER



YATO	Ø (mm)	d (mm)	R.P.M.max.	D (mm)	metal disc thickness / grubość tarczy (mm)	number of teeth / ilość zębów (T)	
YT-6050	130	16.0	10000	2.8	2.0	24	25/50
YT-6052	140	20.0	10000	2.8	2.0	16	25/50
YT-60522	140	20.0	11000	2.8	2.0	30	25/50
YT-6053	140	16.0	10000	2.8	2.0	30	25/50
YT-60532	150	20.0	10000	2.8	2.0	18	25/50
YT-60533	150	20.0	10000	2.8	2.0	30	25/50
YT-6055	160	20.0	9500	2.8	2.0	18	25/50
YT-6056	160	30.0	9500	2.8	2.0	24	25/50
YT-6057	160	30.0	9500	2.8	2.0	36	25/50
YT-6058	160	20.0	9500	2.8	2.0	48	25/50
YT-60582	170	16.0	9500	3.2	2.2	12	25/50
YT-60583	170	16.0	9500	3.2	2.2	40	25/50
YT-6060	184	30.0	9000	3.2	2.2	24	25/50
YT-6061	184	30.0	9000	3.2	2.2	40	25/50
YT-6062	184	30.0	9000	3.2	2.2	50	25/50
YT-6063	185	20.0	9000	2.4	1.4	18	25/50
YT-60632	190	16.0	8500	3.2	2.2	12	10/20
YT-60633	190	16.0	8500	3.2	2.2	40	10/20
YT-60634	190	20.0	7100	2.2	1.5	24	25/50
YT-60488	190	30.0	8500	3.2	2.2	20	10/20
YT-60489	190	30.0	8500	3.2	2.2	40	10/20

YATO	Ø (mm)	d (mm)	R.P.M.max.	D (mm)	metal disc thickness / grubość tarczy (mm)	number of teeth / ilość zębów (T)	
YT-6065	200	30.0	8000	3.2	2.2	24	10/20
YT-60652	210	30.0	8000	3.2	2.2	40	10/20
YT-6066	205	18.0	6000	3.2	2.0	24	10/20
YT-60665	210	30.0	7500	3.2	2.2	20	10/20
YT-6067	210	30.0	8000	3.2	2.2	40	10/20
YT-6068	210	30.0	8000	3.2	2.2	60	10/20
YT-60682	216	30.0	7500	3.2	2.2	48	10/20
YT-60668	235	25.5	5800	2.5	1.8	24	25
YT-6070	250	30.0	6000	3.2	2.2	24	10/20
YT-6071	250	30.0	6000	3.2	2.2	40	10/20
YT-6072	250	30.0	6000	3.2	2.2	60	10/20
YT-6075	300	30.0	6000	3.2	2.2	24	10
YT-6076	300	30.0	5000	3.2	2.2	40	10
YT-6077	300	30.0	5000	3.2	2.2	60	10
YT-6078	300	30.0	5000	3.2	2.2	96	10
YT-6080	350	30.0	4500	3.5	2.5	28	10
YT-6081	350	30.0	4500	3.5	2.5	40	10
YT-6082	350	30.0	4500	3.5	2.5	54	10
YT-6083	350	30.0	4500	3.5	2.5	84	10
YT-6085	400	30.0	4000	3.8	2.8	32	10
YT-6086	400	30.0	4000	3.8	2.8	60	10

- GB TCT circular saw blade for structural wood
D Kreissägeblatt HM-Bestückt von Holzkonstruktionen
PL Piła tarczowa z węglikiem wolframu do cięcia drewna konstrukcyjnego
RUS Диск пильный твердого сплава для резки строительной конструкционной древесины
CZ Kotoučová pila s karbidem wolframu k řezání konstrukčního dřeva
H Wolfram-karbid szegmens fűrészártsza szerkezeti fához
RO Ferăstrău circular cu dinți din wolfram pt. tăierea lemnului pt. construcții
F Lame de scie circulaire carbure pour construction bois
I Lama al tungsteno da legno
E Disco de sierra con carbono de tungsteno para corte de madera estructural
CN 木工圆锯片

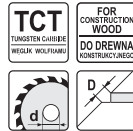

DOUBLE BLISTER



YATO	Ø (mm)	d (mm)	R.P.M.max.	D (mm)	metal disc thickness / grubość tarczy (mm)	number of teeth / ilość zębów (T)	
YT-60480	160	20	9500	2.2	1.5	24	25/50
YT-60482	180	20	9000	2.4	1.8	36	20/40
YT-60484	250	30	6000	2.4	1.8	48	10/20

- GB TCT circular saw blade for aluminium
D Hartmetallbestückt Kreissägeblatt für Aluminium
PL Piła tarczowa do aluminium z węglikiem wolframu
RUS Диск пильный по алюминию
CZ Kotoučová pila na hliník s karbidem wolframu
H Wolframkarbidos körfűrészlap, aluminiumhoz
RO Disc circular pt. aluminiu
F Lame de scie circulaire pour aluminium
I Lama troncatrice alluminio
E Disco de sierra con carbono
CN 锯片

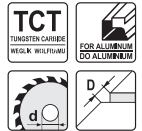

- application: for cutting aluminium profiles, laminates, plexi, corian and other plastics
- negative angle of teeth
- przeznaczenie: do cięcia profili aluminiowych, laminatów, plexi, korianu, tworzyw sztucznych
- negatywny kąt natarcia zębów

DOUBLE BLISTER



YATO	Ø (mm)	d (mm)	R.P.M.max.	D (mm)	metal disc thickness / grubość tarczy (mm)	number of teeth / ilość zębów (T)	
YT-60905	160	20	9500	2.2	1.5	52	25/50
YT-60907	180	20	9000	2.2	1.5	60	20/40
YT-6091	200	30	8000	3.0	2.2	60	10/20
YT-6093	210	30	8000	3.0	2.2	72	10/20
YT-6095	250	30	6000	3.0	2.2	100	10/20
YT-6097	300	30	5000	3.0	2.2	100	10
YT-6099	350	30	4500	3.2	2.5	100	10

- GB Metal cutting disc
- D Trennscheibe für Metall
- PL Tarcza do cięcia metalu
- RUS Диск отрезной по металлу
- CZ Kotouč pro řezání kovu
- H Vágókorong fémhez
- RO Disc debitat metale
- F Lame de scie pour métaux
- I Disco per taglio metallo
- E Disco cortador para metalo
- CN 锯片

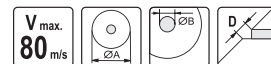

INOX

YATO	∅A (mm)	∅B (mm)	D (mm)	R.P.M.max.	PCS packing	
YT-6101	115	22	1.2	13200	5	25/200
YT-6102	115	22	2.5	13200	5	25/200
YT-6103	125	22	1.2	12200	5	25/200
YT-6104	125	22	2.5	12200	5	25/200
YT-6105	180	22	1.5	8600	5	25/50
YT-6106	180	22	2.5	8600	5	25/100
YT-6107	230	22	2.0	6500	5	25/50
YT-6108	230	22	3.2	6500	5	25/50

10



YATO	∅A (mm)	∅B (mm)	D (mm)	R.P.M.max.	PCS packing	
YT-5920	115	22	1.2	13200	5	25/200
YT-5921	115	22	2.5	13200	5	25/200
YT-5923	125	22	1.2	12200	5	25/200
YT-5924	125	22	2.5	12200	5	25/200
YT-6110	125	22	3.2	12200	5	25/200
YT-5925	180	22	1.5	8600	5	25/50
YT-5926	180	22	2.5	8600	5	25/50
YT-6111	180	22	3.2	8600	5	25/100
YT-5927	230	22	2.0	6500	5	25/50
YT-6112	230	22	3.2	6500	5	25/50
YT-6113	300	32	3.2	5100	5	25
YT-6136	350	32	3.5	4400	5	25
YT-6137	400	32	4.0	3800	5	25

- GB Metal cutting disc
- D Trennscheibe für Metall
- PL Tarcza do cięcia metalu
- RUS Диск отрезной по металлу
- CZ Kotouč pro řezání kovu
- H Vágókorong fémhez
- RO Disc debitat metale
- F Lame de scie pour métaux
- I Disco per taglio metallo
- E Disco cortador para metalo
- CN 锯片

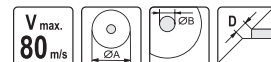

for / dla: YT-82180

YATO	∅A (mm)	∅B (mm)	D (mm)	R.P.M.max.	PCS
YT-61132	355	25.4	3.2	4400	25

- GB Metal cutting disc
- D Trennscheibe für Metall
- PL Tarcza do cięcia metalu
- RUS Диск отрезной по металлу
- CZ Kotouč pro řezání kovu
- H Vágókorong fémhez
- RO Disc debitat metale
- F Lame de scie pour métaux
- I Disco per taglio metallo
- E Disco cortador para metalo
- CN 锯片



• depressed center • wypukła

YATO	∅A (mm)	∅B (mm)	D (mm)	R.P.M.max.	PCS packing	
YT-6114	115	22	2.5	13200	5	25/200
YT-6116	125	22	2.5	12200	5	25/200
YT-6117	125	22	3.2	12200	5	25/200
YT-6120	230	22	3.2	6500	5	25/50

- GB Metal grinding disc
D Metall-Schleifscheibe
PL Tarcza do szlifowania metalu
RUS Круги для шлифования по металлу
CZ Kotouč pro broušení kovu
H Vágókorong fémhez
- RO Disc pt. șlefuit metal
F Disque de polissage pour métaux
I Disco per rettifica metallo
E Disco cortador para metalo
CN 锯片

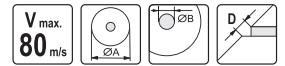

INOX

• depressed center • wypukła

• depressed center • wypukła

YATO	øA (mm)	øB (mm)	D (mm)	R.P.M.max.	PCS packing	
YT-6121	115	22	6.0	13200	5	25/100
YT-6123	115	22	8.0	13200	5	25/100
YT-6124	125	22	6.0	12200	5	30/120
YT-6126	125	22	8.0	12200	5	25/100
YT-6138	180	22	6.8	8600	5	15/30
YT-6125	230	22	6.0	6500	5	5/30

YATO	øA (mm)	øB (mm)	D (mm)	R.P.M.max.	PCS packing	
YT-5946	115	22	6.0	13200	5	25/100
YT-5947	125	22	6.8	12200	5	25/100

- GB Stone cutting disc
D Trenscheibe für Stein
PL Tarcza do cięcia kamienia
RUS Диск отрезной по камню
CZ Kotouč pro řezání kamene
H Vágókorong kőhöz
- RO Disc pt. tăiat piatră
F Disque de coupe pour granit
I Disco per taglio pietra
E Disco cortador de piedra
CN 石材锯片

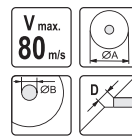

- GB Stone grinding disc
D Stein-schleifscheibe
PL Tarcza do szlifowania kamienia
RUS Диск для шлифования по камню
CZ Kotouč pro broušení kamene
H Csiszolókorong kőhöz
RO Disc pt. șlefuit piatră
F Disque de polissage pour granit
I Disco per rettifica pietra
E Disco cortador de piedra
CN 锯片



• depressed center • wypukła

• depressed center • wypukła

YATO	øA (mm)	øB (mm)	D (mm)	R.P.M.max.	PCS packing	
YT-5930	115	22	1.5	13200	5	25/200
YT-5932	125	22	1.5	12200	5	25/200
YT-5933	125	22	3.2	12200	5	25/200
YT-5935	230	22	3.2	6500	5	25/50

YATO	øA (mm)	øB (mm)	D (mm)	R.P.M.max.	PCS packing	
YT-6128	115	22	3.2	13200	5	25/200
YT-6129	125	22	3.2	12200	5	25/200
YT-6131	230	22	3.2	6500	5	25/50

YATO	øA (mm)	øB (mm)	D (mm)	R.P.M.max.	PCS packing	
YT-6132	115	22	6.0	13200	5	25/100
YT-6133	125	22	6.8	12200	5	25/100

- GB Cable cutter
- D Kabelschere
- PL Szczypce do cięcia przewodów
- RUS Кабелерезы
- CZ Elektrické upichováky
- H Kábelvágó
- RO Patent tăietor pt. electrice
- F Pince à couper les fils
- I Pinze per tagliare i cavi
- E Tijeras para cables
- CN 电缆剪



SLIDING CARD



	160 mm	210 mm
	240 mm	CrV 50 DROPP FORGED STEEL STAL KUTA NA ŽEMNO
		HRC 55-60

YATO	L (mm)	max. Ø (mm)	
YT-1966	160	6	6/60
YT-1967	210	7	6/60
YT-1968	240	8	6/48

- application: for copper and aluminium electric cables
- przeznaczenie: do cięcia miedzianych i aluminiowych kabli

- GB Insulated cable cutter
- D Kabelschere
- PL Szczypce do cięcia przewodów izolowane
- RUS Кабелерезы
- CZ Elektrické upichováky, izolované
- H Kábelvágó
- RO Cleste taiat cabluri izolat
- F Pince renforcée isolée
- I Pinze per tagliare i cavi isolati
- E Tijeras para cables aislantes
- CN 绝缘电缆剪



	250 mm	CrV	1000 V	
--	--------	-----	--------	--

1000V VDE CERTIFICATE EN 60900:2012

YATO	L (mm)	max. Ø (mm)	
YT-21141	250	80	6/36

- GB Heavy duty cable cutter
- D Schwere Drahtschere
- PL Wzmocnione nożyce do cięcia przewodów
- RUS Кабелерезы
- CZ Elektrické upichováky

- H Kábelvágó
- RO Patent tăietor pt. electrice
- F Pince renforcée à couper les fils

- I Pinze per tagliare i cavi
- E Tijeras para cables
- CN 电缆剪



SLIDING CARD



	240 mm	CrV 50 DROPP FORGED STEEL STAL KUTA NA ŽEMNO	HRC 55-60
--	--------	--	-----------

YATO	L (mm)	max. Ø (mm)	
YT-1969	240	9	6/48

- application: for copper and aluminium electric cables
- przeznaczenie: do cięcia miedzianych i aluminiowych kabli

- GB Heavy duty cable cutter
- D Schwere Drahtschere
- PL Wzmocnione nożyce do cięcia przewodów
- RUS Кабелерезы
- CZ Elektrické upichováky
- H Kábelvágó
- RO Patent tăietor pt. electrice
- F Pince renforcée à couper les fils
- I Pinze per tagliare i cavi
- E Tijeras para cables
- CN 电缆剪



SLIDING CARD



	230 mm	HRC 58-61	CrMo
Lever for increase cutting power		Ideal for copper and aluminium electric cables	

YATO	L (mm)	max. Ø (mm)	
YT-1933	230	9	6/36

- GB Tin snips
- D Blechscher
- PL Nożyce do cięcia blachy
- RUS Ножницы по металлу
- CZ Nůžky na plech
- H Lemezvágó olló
- RO Foarfece pt. tablă
- F Cisaille à tôle
- I Cesioie per lamiera
- E Tijeras para chapas
- CN 铁皮剪

SLIDING CARD



S55C DROPP FORGED STEEL STAL KUTA NA ŽEMNO	HRC 55-60	HIGH FREQUENCY HARDENING HARTOWANIE IMPULSOWE
--	-----------	--



- GB Tin snips
- D Blechscher
- PL Nożyce do cięcia blachy
- RUS Ножницы по металлу
- CZ Nůžky na plech
- H Lemezvágó olló
- RO Foarfece pt. tablă
- F Cisaille à tôle
- I Cesioie per lamiera
- E Tijeras para chapas
- CN 铁皮剪

SLIDING CARD



S55C DROPP FORGED STEEL STAL KUTA NA ŽEMNO	HRC 55-60	HIGH FREQUENCY HARDENING HARTOWANIE IMPULSOWE
--	-----------	--



YATO	L (mm)	cutting length (mm)	cutting capacities (mm)				
			copper	cold-rolled steel	hard steel HRC35	stainless steel 304	
YT-1963	200	40	1.5	1.0	0.6	0.6	6/36
YT-1964	250	60	1.8	1.2	0.8	0.8	6/24
YT-1965	300	75	2.0	1.4	0.8	0.8	6/12

YATO	L (mm)	cutting length (mm)	cutting capacities (mm)				
			copper	cold-rolled steel	hard steel HRC35	stainless steel 304	
YT-1970	260	42	2.0	1.4	1.0	1.0	6/36

GB Tin snips
D Blechscherer
PL Nożyce do cięcia blachy

RUS Ножницы по металлу
CZ Nůžky na plech
H Lemezvágó olló

RO Foarfece pt. tablă
F Cisaillie à tôle
I Cesioie per lamiere

E Tijeras para chapas
CN 铁皮剪

SLIDING CARD



LEFT CUT
CIECIE LEWE

CrMo

INCREASED CUTTING POWER
ZWIĘKSZONA SIŁA CIĘCIA

HRC 60-62

DIN 6438

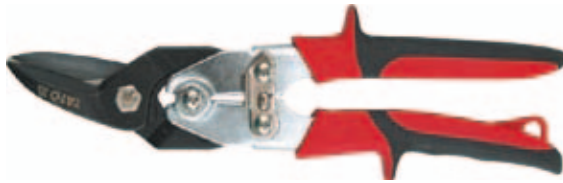

HRC 60-62

DIN 6438



YATO	L (mm)	cutting length (mm)	cutting capacities (mm)				6/36
			copper	cold-rolled steel	hard steel HRC35	stainless steel 304	
YT-1910	260	35	1.80	1.50	1.00	0.90	6/36

YATO	L (mm)	cutting length (mm)	cutting capacities (mm)				6/36
			copper	cold-rolled steel	hard steel HRC35	stainless steel 304	
YT-1915	235	30	1.50	1.20	1.00	0.70	6/36

HRC 60-62

DIN 6438

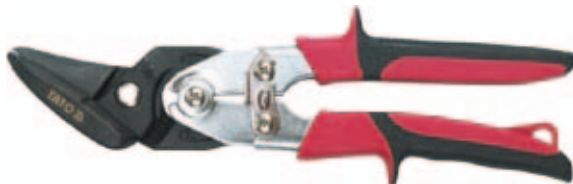

HRC 56-62

SERRATED EDGES
ZĄBKOWANA KRAWIEŻ OSTRZY

HIGH FREQUENCY HARDENING
HARTOWANIE IMPULSOWE



YATO	L (mm)	cutting length (mm)	cutting capacities (mm)				6/36
			copper	cold-rolled steel	hard steel HRC35	stainless steel 304	
YT-1918	260	32	1.80	1.50	1.00	0.90	6/36

YATO	L (mm)	cutting length (mm)	cutting capacities (mm)				6/36
			copper	cold-rolled steel	hard steel HRC35	stainless steel 304	
YT-1960	250	40	2.00	1.50	1.00	0.80	6/36

GB Tin snips
D Blechscherer
PL Nożyce do cięcia blachy
RUS Ножницы по металлу
CZ Nůžky na plech
H Lemezvágó olló
RO Foarfece pt. tablă
F Cisaillie à tôle
I Cesioie per lamiere
E Tijeras para chapas
CN 铁皮剪



LEFT CUT
CIECIE LEWE

HRC 60-62

CrMo

90°

SERRATED EDGES
ZĄBKOWANA KRAWIEŻ OSTRZY



SLIDING CARD



YATO	L (mm)	cutting length (mm)	cutting capacities (mm)				6/36
			copper	cold-rolled steel	hard steel HRC35	stainless steel 304	
YT-1913	225	30	0.78	0.53	0.46	0.36	6/36

GB Tin snips
D Blechscherer
PL Nożyce do cięcia blachy

RUS Ножницы по металлу
CZ Nůžky na plech
H Lemezvágó olló

RO Foarfece pt. tablă
F Cisaillie à tôle
I Cesioie per lamiere

E Tijeras para chapas
CN 铁皮剪

SLIDING CARD



STRAIGHT CUT
CIECIE PROSTE

CrMo

INCREASED CUTTING POWER
ZWIĘKSZONA SIŁA CIĘCIA

HRC 60-62

DIN 6438

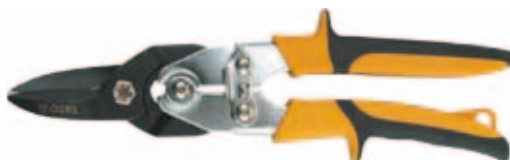

HRC 60-62

DIN 6438



YATO	L (mm)	cutting length (mm)	cutting capacities (mm)				6/36
			copper	cold-rolled steel	hard steel HRC35	stainless steel 304	
YT-1912	260	35	1.80	1.50	1.00	0.90	6/36

YATO	L (mm)	cutting length (mm)	cutting capacities (mm)				6/36
			copper	cold-rolled steel	hard steel HRC35	stainless steel 304	
YT-1922	290	75	1.10	0.94	0.70	0.53	6/36

HRC 60-62

DIN 6438



HRC 56-62

SERRATED EDGES
ZĄBKOWANA KRAWIEŻ OSTRZY

HIGH FREQUENCY HARDENING
HARTOWANIE IMPULSOWE



YATO	L (mm)	cutting length (mm)	cutting capacities (mm)				6/36
			copper	cold-rolled steel	hard steel HRC35	stainless steel 304	
YT-1923	230	25	2.00	1.60	1.20	1.20	6/36

YATO	L (mm)	cutting length (mm)	cutting capacities (mm)				6/36
			copper	cold-rolled steel	hard steel HRC35	stainless steel 304	
YT-1962	250	45	2.00	1.50	1.00	0.80	6/36

GB Tin snips
D Blechscherer
PL Nożyce do cięcia blachy

RUS Ножницы по металлу
CZ Nůžky na plech
H Lemezvágó olló

RO Foarfece pt. tablă
F Cisaille à tôle
I Cesioie per lamiere

E Tijeras para chapas
CN 铁皮剪

SLIDING CARD



RIGHT CUT
CIECIE PRAWO

CrMo

INCREASED CUTTING POWER
ZWIĘKSZONA SIŁA CIĘCIA

HRC 60-62

DIN 6438



YATO	L (mm)	cutting length (mm)	cutting capacities (mm)				6/36
			copper	cold-rolled steel	hard steel HRC35	stainless steel 304	
YT-1911	260	35	1.80	1.50	1.00	0.90	6/36

HRC 60-62

DIN 6438



YATO	L (mm)	cutting length (mm)	cutting capacities (mm)				6/36
			copper	cold-rolled steel	hard steel HRC35	stainless steel 304	
YT-1916	235	30	1.50	1.20	1.00	0.70	6/36

HRC 60-62

DIN 6438



YATO	L (mm)	cutting length (mm)	cutting capacities (mm)				6/36
			copper	cold-rolled steel	hard steel HRC35	stainless steel 304	
YT-1919	260	32	1.80	1.50	1.00	0.90	6/36

HRC 56-62

SERRATED EDGES
ZABKOWANA KRAWĘDZ OSTRZY

HIGH FREQUENCY HARDENING
HARTOWANIE IMPULSOWE



YATO	L (mm)	cutting length (mm)	cutting capacities (mm)				6/36
			copper	cold-rolled steel	hard steel HRC35	stainless steel 304	
YT-1961	250	40	2.00	1.50	1.00	0.80	6/36

GB Tin snips
D Blechscherer
PL Nożyce do cięcia blachy
RUS Ножницы по металлу
CZ Nůžky na plech
H Lemezvágó olló

RO Foarfece pt. tablă
F Cisaille à tôle
I Cesioie per lamiere
E Tijeras para chapas
CN 铁皮剪

RIGHT CUT
CIECIE PRAWO

HRC 60-62

CrMo

90°

SERRATED EDGES
ZABKOWANA KRAWĘDZ OSTRZY



SLIDING CARD



YATO	L (mm)	cutting length (mm)	cutting capacities (mm)				6/36
			copper	cold-rolled steel	hard steel HRC35	stainless steel 304	
YT-1914	225	30	0.78	0.53	0.46	0.36	6/36

GB Tin snips
D Blechscherer
PL Nożyce do cięcia blachy
RUS Ножницы по металлу
CZ Nůžky na plech
H Lemezvágó olló
RO Foarfece pt. tablă
F Cisaille à tôle
I Cesioie per lamiere
E Tijeras para chapas
CN 铁皮剪



SLIDING CARD



LEFT CUT
CIECIE LEWE

DROP FORGED
KUTE

HRC 58-61

YATO	L (mm)	cutting length (mm)	cutting capacities (mm)				6/24
			copper	cold-rolled steel	hard steel HRC35	stainless steel 304	
YT-1900	260	30	0.94	0.78	0.60	0.45	6/24

GB Tin snips
D Blechscherer
PL Nożyce do cięcia blachy
RUS Ножницы по металлу

CZ Nůžky na plech
H Lemezvágó olló
RO Foarfece pt. tablă
F Cisaille à tôle

I Cesioie per lamiere
E Tijeras para chapas
CN 铁皮剪

SLIDING CARD



RIGHT CUT
CIECIE PRAWO

DROP FORGED
KUTE

HRC 58-61



YATO	L (mm)	cutting length (mm)	cutting capacities (mm)				6/24
			copper	cold-rolled steel	hard steel HRC35	stainless steel 304	
YT-1901	260	30	0.94	0.78	0.60	0.45	6/24

YATO	L (mm)	cutting length (mm)	cutting capacities (mm)				6/24
			copper	cold-rolled steel	hard steel HRC35	stainless steel 304	
YT-1902	300	50	0.94	0.78	0.60	0.45	6/24

GB Tin snips
D Blechscherer
PL Nożyce do cięcia blachy
RUS Ножницы по металлу
CZ Nůžky na plech
H Lemezvágó olló
RO Foarfece pt. tablă
F Cisaille à tôle
I Cesioie per lamiere
E Tijeras para chapas
CN 铁皮剪



SLIDING CARD



For cutting straight and tight curves left or right

HRC 58-61

YATO	L (mm)	cutting length (mm)	cutting capacities (mm)				6/36
			copper	cold-rolled steel	hard steel HRC35	stainless steel 304	
YT-1924	254	52	0.94	0.78	0.60	0.45	6/36

GB Tin snips
D Blechscherer
PL Nożyce do cięcia blachy
RUS Ножницы по металлу

CZ Nůžky na plech
H Lemezvágó olló
RO Foarfece pt. tablă
F Cisaille à tôle

I Cesioie per lamiere
E Tijeras para chapas
CN 铁皮剪

SLIDING
CARD



For cutting
straight and
tight curves
left or right

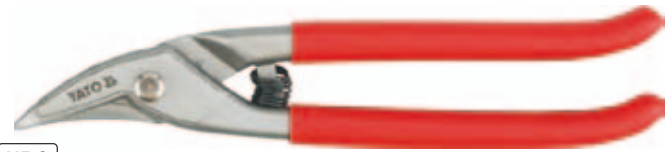

STRAIGHT
CUT
CIECIE
PROSTE

HRC
58-61

DROP
FORGED
KUTE

HRC
58-60

YATO	L (mm)	cutting length (mm)	cutting capacities (mm)				6/36
			copper	cold-rolled steel	hard steel HRC35	stainless steel 304	
YT-1925	225	52	0.94	0.78	0.60	0.45	6/36

YATO	L (mm)	cutting length (mm)	cutting capacities (mm)				6/36
			copper	cold-rolled steel	hard steel HRC35	stainless steel 304	
YT-1920	260	42	1.20	1.00	0.60	0.50	6/36

GB Portable notchers
D Schere zum Ausschneiden von Ecken
PL Nożyce do wycinania naroży
RUS Ножницы для наружных углов

CZ Nůžky na vystřihování rohů
H Sarokkivágó olló
RO Foarfece pt. taierea colturilor
F Ciseaux pour le coupage des coins

I Cesioie per taglio reggetta in angoli
E Tijeras para esquinas
CN 截角器

300
mm

90°

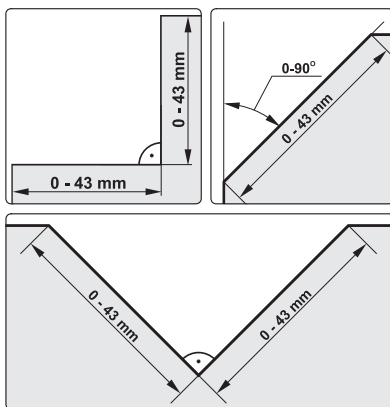

YATO	L (mm)	6/36
YT-1939	300	15

GB Steel strap cutter
D Stahlgurblechscherer
PL Nożyce do cięcia taśmy stalowej
RUS Ножницы для резки стальной ленты
CZ Nůžky na plech
H Lemezvágó olló

RO Foarfece pt. tablă
F Cisaille à bande acier
I Cesioia per taglio reggetta in acciaio
E Tijeras para bandejas de acero
CN 钢带剪

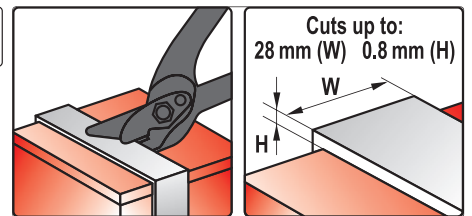

YATO	L (mm)	cutting length (mm)	cutting capacities (mm)				6/24
			copper	cold-rolled steel	hard steel HRC35	stainless steel 304	
YT-1930	305	28	-	1.00	0.80	0.60	6/24

GB Bolt cutter
D Drahtschere
PL Nożyce do prętów
RUS Болторез
CZ Nůžky na tyče

H Kábelvágó olló
RO Foarfece pt. bare
F Cisaille pour barres
I Cesioie taglia bulloni

E Cortavarillas
CN 断线钳

HRC
56-61

CrMo



YATO	size / rozmiar	max. Ø (mm)		6/24
		soft / miękki	medium / średnio twardy	
YT-1843	12" (300 mm)	5	4	20
YT-1844	14" (350 mm)	7	5	10
YT-1845	18" (450 mm)	8	6	10
YT-1846	24" (600 mm)	10	8	6
YT-1847	30" (750 mm)	13	10	4
YT-1848	36" (900 mm)	16	12	3

GB Bolt cutter
D Drahtschere
PL Nożyce do prętów

RUS Болторез
CZ Nůžky na tyče
H Kábelvágó olló

RO Foarfece pt. bare
F Cisaille pour barres
I Cesioie taglia bulloni

E Cortavarillas
CN 断线钳

CrMo



YATO	size / rozmiar	max. Ø (mm)	6/24
YT-1851	14" (350 mm)	6	6/24
YT-1852	18" (450 mm)	7	6/12
YT-1853	24" (600 mm)	10	2/12
YT-1854	30" (750 mm)	12	6
YT-1855	36" (900 mm)	14	4
YT-1856	42" (1050 mm)	16	2

- GB Hydraulic cutter
 D Manueller Hydraulikschneider
 PL Ręczny obcinak hydrauliczny
 RUS Ручной гидравлический резак
- CZ Rucni hydraulický odřezávac
 H Kézi hidraulikus betonacélvágó
 RO Cutit pt. retezat tevi
 F Coupe manuelle hydraulique
- I Cesoia idraulica manuale
 E Cortadora hidráulica manual
 CN 液压剪

BMC & COLOR SLEEVE



STEEL
STAL



YATO	cutting diameter / średnica cięcia (mm²)	L (mm)	pressure / nacisk (T)	
YT-22870	4-12	320	6	5

YATO	cutting diameter / średnica cięcia (mm²)	L (mm)	pressure / nacisk (T)	
YT-22871	4-16	430	8	5
YT-22872	4-20	515	13	3

- GB Heads for hydraulic cutter
 D Austauschmesser für Hydraulikschneider
 PL Noże wymienne do obcinaka hydraulicznego
 RUS Сменные ножи для гидравлического резака
- CZ Vyměnitelné nože do hydraulického odřezávac
 H Cserekés a hidraulikus betonacélvágóhoz
 RO Lame schimbabile pt. cutit pt. retezat tevi
 F Lame pour coupe manuelle hydraulique
- I Teste per coltelli idraulici
 E Cuchillas intercambiables para cortadora hidráulica
 CN 液压钳钳口配件

2
PCS



SLIDING
CARD

YATO	for / dla	size / rozmiar (mm)	
YT-22873	YT-22870	12	10/100
YT-22874	YT-22871	16	10/100
YT-22875	YT-22872	20	10/100

10

- GB Ratchet cable cutter
 D Ratschenkabelschneider
 PL Nożyce zapadkowe do kabli
 RUS Кабелерез секторный
- CZ Kleště na kabely, rohatka se západkou
 H Racsnis kábelvágó
 RO Cleste pt. taiat cablu cu clichet
- F Cisailles à câbles
 I Cricchetto taglia cavo
 E Cortacables de carraca
 CN 棘轮电缆剪

COLOR BOX



Cu/Al
CABLE
KABEL

60Si2Mn

HRC 50
CUTTING BLADE
OSTRZE TNACIE

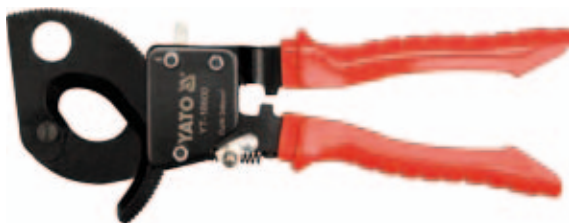

YATO	cutting range / max. przekrój cięcia (mm²)	max. Ø (mm)	L (mm)	
YT-18600	240	17.5	300	10

YATO	cutting range / max. przekrój cięcia (mm²)	max. Ø (mm)	L (mm)	
YT-18602	380	22	380	10

- GB Cable cutter
 D Kabelschere
 PL Nożyce do kabli
 RUS Кабелерезы
 CZ Elektrické upichováky
 H Kábelvágó
 RO Patent tăietor pt. electrice
 F Cisailles à câbles
 I Cesoie per cavi
 E Tijeras para cables
 CN 电缆剪



STEEL
STAL

COLOR BOX



YATO	cutting range / max. przekrój cięcia (mm²)	max. Ø (mm)	L (mm)	
YT-18610	125	12.5	370	20
YT-18611	250	18.0	580	10
YT-18612	500	25.0	770	5

- GB Multi function scissors
 D Multifunktionsmesser
 PL Nożyce wielofunkcyjne
 RUS Ножницы многофункциональные
 CZ Víceúčelové nůžky
 H Többfunkciós olló
 RO Foarfece multifuncțional
 F Cisailles universelle
 I Cesoie multifunzione
 E Tijeras multifuncionales
 CN 多用剪



65
mm

3Cr13
STAINLESS
STEEL
STAL
NIERÓŻEWA

HRC
50-54

SLIDING
CARD



YATO	L (mm)	
YT-1976	65	12/72

- GB Hand saw for wood
D Handsäge
PL Piła płatnica do drewna
RUS Пила по дереву
CZ Pila na dřevo platnice
H Fafűrész, egyenes
RO Ferăstrău pt. lemn
F Scie
I Seghetto per legno
E Serrucho para madera
CN 手板锯



COLOR SLEEVE

Mn 65	7T inch
1.6 mm 0.9 mm	HRC 50-54

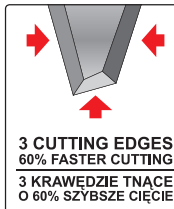

- GB Back saw
D Rucksäge
PL Piła grzbietnica
RUS Пила для стула
CZ Pila hřebenovka
H Kézfűrész
RO Ferăstrău coadă de vulpe
F Scie
I Segà con dorso
E Serrucho de costilla
CN 夹背锯

300 mm	Mn 65	12T inch
1.2 mm 0.8 mm	HRC 50-54	



COLOR SLEEVE



YATO	L (mm)	
YT-3130	300	12/60



YATO	L (mm)	
YT-3101	400	12/48
YT-3102	450	10/40
YT-3103	500	10/40



YATO	L (mm)	
YT-3106	400	12/48
YT-3107	450	10/40
YT-3108	500	10/40

PTFE
COATED

- GB Compass saw
D Stichsäge
PL Piła otwornica
RUS Выкружная пила
CZ Pila otwornice
H Lyukfűrész
RO Ferăstrău coadă de șoarece
F Scie étroite
I Segà a foretto
E Serrucho de punta
CN 鸡尾锯

300 mm	Mn 65	7T inch
1.6 mm 0.9 mm	HRC 50-54	



COLOR SLEEVE

YATO	L (mm)	
YT-3133	300	12/60

- GB Wallboard saw
D Gipsäge
PL Piła do gipsów
RUS Ножовка по гипсокартону
CZ Pila na sádrú
H Gipszfűrész
RO Ferăstrău pt. ghips
F Scie pour plaques de plâtre
I Segà per cartongesso
E Serrucho para cartón yeso
CN 墙板锯

150 mm	Mn 65	7T inch
2.0 mm 1.5 mm	HRC 50-54	



COLOR SLEEVE

YATO	L (mm)	
YT-3134	150	12/60

- GB Plastic mitre box with dovetail saw
D Kunststoffschneidladen mit Säge
PL Plastikowa skrzynka uciosowa z piłą
RUS Стуло пластмассовое с пилой
CZ Přípravek na řezání úhlú s pilkou
H Gërbevágó műanyagláda hód farkú fűrészszel
RO Pasuitor + cutie
F Boîte à onglets + scie
I Taglia cornici in plastica con segà
E Guía de ingletar y sierra
CN 燕尾锯



COLOR BOX

350 mm	Mn 65	12T inch
1.2 mm 0.8 mm	HRC 50-54	ABS

300x140 x70mm



YATO	L (mm)	
YT-3150	350	10

- GB Bow saw
D Bùgelsäge
PL Piła kabląkowa
RUS Лучковая пила
CZ Oblouková pila
H Keretes fűrész
RO Ferăstrău de curbură
F Scie à bûches
I Segà ad arco
E Sierra de arco
CN 两用弓锯

COLOR SLEEVE



HCS 65



2
FUNCTION
FOR WOOD
AND METAL
DO DREWNA
I METALU

YATO	L (mm)	
YT-3200	300	12/24

FOR WOOD
DO DREWNA

YATO	L (mm)	
YT-3201	450	12/24
YT-3202	530	
YT-3203	610	
YT-3204	760	

GB Blade for dry wood
 D Trockenholzsägeblatt für Handsäge
 PL Brzeczot do drewna suchego
 RUS Лезвие для работы по сухому дереву
 CZ Pilový list na suché dřevo

H Fűrészlap száraz fához
 RO Lama pt. lemn uscat
 F lame à bois sec
 I Lama per il legno secco
 E Hoja de sierra para madera seca
 CN 干木锯条

HCS
65

DRY
WOOD
DREWN
SUCHE



COLOR SLEEVE

YATO	L (mm)	
YT-3221	450	50/200
YT-3222	530	
YT-3223	610	
YT-3224	760	

GB Blade for wet wood
 D Nassholzsägeblatt für Handsäge
 PL Brzeczot do drewna mokrego
 RUS Лезвие для работы по влажному дереву
 CZ Pilový list na mokré dřevo

H Fűrészlap nedves fához
 RO Lama pt. lemn verde
 F lame à bois humide
 I Lama per il legno bagnato
 E Hoja de sierra para madera mojada
 CN 湿木锯条

HCS
65

WET
WOOD
DREWN
MOKRE



COLOR SLEEVE

YATO	L (mm)	
YT-3230	300	50/200
YT-3231	450	
YT-3232	530	
YT-3233	610	
YT-3234	760	

GB Hacksaw frame
 D Metallbogensäge
 PL Pila do metalu
 RUS Пила по металлу
 CZ Pílka na železo
 H Fémfűrész

RO Ferăstrău cu cadru metalic
 F Scie à métal
 I Seghetto per metallo
 E Sierra de metalo
 CN 锯架

COLOR
SLEEVE



BI-METAL

24
TPI

FOR
METAL
DO
METALU



YATO	L (mm)	
YT-3160	300	10



YATO	L (mm)	
YT-3161	300	6/36



YATO	L (mm)	
YT-3163	300	5/20

GB Hacksaw frame blade
 D Metallsägeblatt
 PL Brzeczot do metalu

RUS Полотна по металлу
 CZ Pilový list na kovy
 H Fémfűrész lap

RO Panza fierastrau pt. metal
 F lame à métal
 I Lama per metallo

E Hoja de sierra para metalo
 CN 锯条

300
mm

12
mm

24
TPI



PLASTIC
HANGER

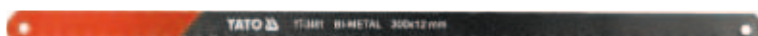

BI-METAL
M2+6150

BI-METAL
M2+Co8%

YATO	L (mm)	W (mm)	TPI	PCS packing:	
YT-3460	300	12	24	5	10/200

YATO	L (mm)	W (mm)	TPI	PCS packing:	
YT-3461	300	12	24	2	20/500

YATO	L (mm)	W (mm)	TPI	PCS packing:	
YT-3462	300	12	24	2	20/500

GB Jig saw blades
D Stichsägeblätter
PL Brzeszczyty do wyrzynarki
RUS Полотно для электр. станка

CZ Pilový list do přímočaré pily
H Dekopírlap
RO Lama fierastrau pendular
F Lames à scie sauteuse

I Scalpelli per il seghetto
E Recambio sierra de calar
CN 曲线锯条

BLISTER
CARD



5
PCS



YATO	L (mm)	working length / długość robocza (mm)	thickness / grubość (mm)	TPI	
YT-3400	100	75	1.27	6	50/250

YATO	L (mm)	working length / długość robocza (mm)	thickness / grubość (mm)	TPI	
YT-3401	100	75	1.3	10	50/250

YATO	L (mm)	working length / długość robocza (mm)	thickness / grubość (mm)	TPI	
YT-3402	100	75	1.2	8	50/250



YATO	L (mm)	working length / długość robocza (mm)	thickness / grubość (mm)	TPI	
YT-3403	100	75	1.3	6	50/250

YATO	L (mm)	working length / długość robocza (mm)	thickness / grubość (mm)	TPI	
YT-3404	100	75	1.3	10	50/250

YATO	L (mm)	working length / długość robocza (mm)	thickness / grubość (mm)	TPI	
YT-3405	100	75	1.3	6	50/250



YATO	L (mm)	working length / długość robocza (mm)	thickness / grubość (mm)	TPI	
YT-3407	75	50	1.0	13	50/250

YATO	L (mm)	working length / długość robocza (mm)	thickness / grubość (mm)	TPI	
YT-3408	115	90	1.3	13-8	50/250

YATO	L (mm)	working length / długość robocza (mm)	thickness / grubość (mm)	TPI	
YT-3409	115	90	1.3	8	50/250

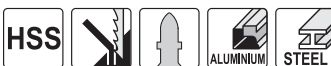

YATO	L (mm)	working length / długość robocza (mm)	thickness / grubość (mm)	TPI	
YT-3410	100	75	1.4	6	50/250

YATO	L (mm)	working length / długość robocza (mm)	thickness / grubość (mm)	TPI	
YT-3411	100	75	1.0	8	25/250

YATO	L (mm)	working length / długość robocza (mm)	thickness / grubość (mm)	TPI	
YT-3412	75	50	1.0	21	25/250

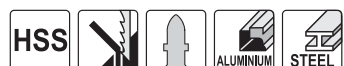

YATO	L (mm)	working length / długość robocza (mm)	thickness / grubość (mm)	TPI	
YT-3413	75	50	1.0	12	25/250

YATO	L (mm)	working length / długość robocza (mm)	thickness / grubość (mm)	TPI	
YT-3414	75	50	1.0	32	25/250

YATO	L (mm)	working length / długość robocza (mm)	thickness / grubość (mm)	TPI	
YT-3415	100	75	1.0	24-10	25/250

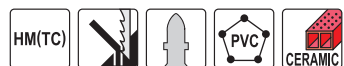
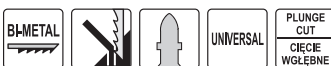
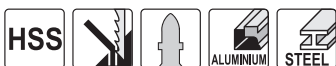

YATO	L (mm)	working length / długość robocza (mm)	thickness / grubość (mm)	TPI	
YT-3416	130	106	1.0	21	25/250

YATO	L (mm)	working length / długość robocza (mm)	thickness / grubość (mm)	TPI	
YT-3417	130	106	1.27	10-5	25/250

YATO	L (mm)	working length / długość robocza (mm)	thickness / grubość (mm)	TPI	
YT-3421	75	50	1.2	-	25/250

GB Jig saw blades
D Stichsägeblätter
PL Brzeszczyty do wyrzynarki
RUS Полотно для электр. станка

CZ Pilový list do přímočaré pily
H Dekopírlap
RO Lama fierastrau pendular
F Lames à scie sauteuse

I Scalpelli per il seghetto
E Recambio sierra de calar
CN 曲线锯条

BLISTER CARD



5 PCS

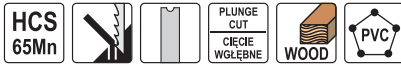

YATO	L (mm)	working length / długość robocza (mm)	thickness / grubość (mm)	TPI	
YT-3430	91.5	74.5	1.3	10	25/250

YATO	L (mm)	working length / długość robocza (mm)	thickness / grubość (mm)	TPI	
YT-3431	91.5	74.5	1.2	8	25/250

YATO	L (mm)	working length / długość robocza (mm)	thickness / grubość (mm)	TPI	
YT-3432	91.5	74.5	1.3	6	25/250



CLEAN CUT

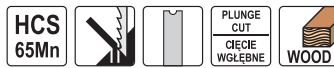

YATO	L (mm)	working length / długość robocza (mm)	thickness / grubość (mm)	TPI	
YT-3433	91.5	74.5	1.3	10	25/250

YATO	L (mm)	working length / długość robocza (mm)	thickness / grubość (mm)	TPI	
YT-3434	108	91	1.3	12-8	

YATO	L (mm)	working length / długość robocza (mm)	thickness / grubość (mm)	TPI	
YT-3435	100	83	1.27	6	25/250



YATO	L (mm)	working length / długość robocza (mm)	thickness / grubość (mm)	TPI	
YT-3440	70	53	1.0	21	25/250

YATO	L (mm)	working length / długość robocza (mm)	thickness / grubość (mm)	TPI	
YT-3441	70	53	1.0	12	25/250

YATO	L (mm)	working length / długość robocza (mm)	thickness / grubość (mm)	TPI	
YT-3442	70	53	1.0	36	25/250



YATO	L (mm)	working length / długość robocza (mm)	thickness / grubość (mm)	TPI	
YT-3443	91.5	74.5	1.0	21-16	25/250

YATO	L (mm)	working length / długość robocza (mm)	thickness / grubość (mm)	TPI	
YT-3444	127	110	1.2	10-5	25/250

GB Jig saw blades
D Stichsägeblätter
PL Brzeszczyty do wyrzynarki
RUS Полотно для электр. станка

CZ Pilový list do přímočaré pily
H Dekopírlap
RO Lama fierastrau pendular
F Lames à scie sauteuse

I Scalpelli per il seghetto
E Recambio sierra de calar
CN 曲线锯条

BLISTER CARD



5 PCS



YATO	L (mm)	working length / długość robocza (mm)	thickness / grubość (mm)	TPI	
YT-3445	100	75	1.3	10	25/250
	100	75	1.3	6	
	100	75	1.27	10	
	75	50	1.0	32	
	75	57	1.0	12	

- GB Half-moon saw blade for oscillating multitool HSS
 D Rundes Sägeblatt HSS für ein Multifunktionswerkzeug
 PL Brzeszczot okrągły HSS do narzędzia wielofunkcyjnego
 RUS Дисковое полотно HSS для многофункционального инструмента
 CZ Segmentový pilový list HSS pro multifunkční nářadí
 H HSS kör keresztmetszetű fűrészlap multifunkciós szerszámhoz
 RO Lamă rotundă HSS pt. unealta multifuncțională
 F lame segment HSS pour outil multifonction
 I Lama di sega circolare per lo strumento multi-funzione HSS
 E Hoja redonda HSS para herramienta multifuncional
 CN 高速钢半圆形锯片

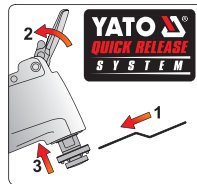

88 mm

HSS

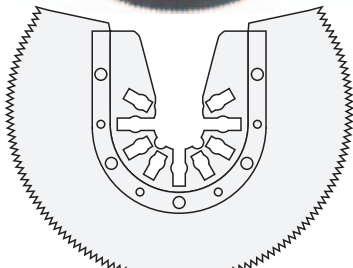

- application: wood, plastic, soft metal, plaster
- zastosowanie: drewno, plastik, miękki metal, gips

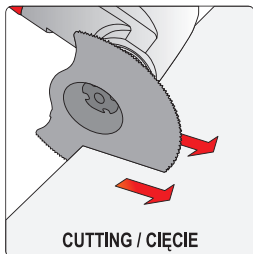

CUTTING / CIĘCIE

for / dla: YT-82220

DOUBLE BLISTER

YATO
YT-34680

5/100

- GB Half-moon saw blade for oscillating multitool HCS
 D Rundes Sägeblatt HCS für ein Multifunktionswerkzeug
 PL Brzeszczot okrągły HCS do narzędzia wielofunkcyjnego
 RUS Дисковое полотно HCS для многофункционального инструмента
 CZ Segmentový pilový list HCS pro multifunkční nářadí
 H HCS kör keresztmetszetű fűrészlap multifunkciós szerszámhoz
 RO Lamă rotundă HCS pt. unealta multifuncțională
 F lame segment HCS pour outil multifonction
 I Lama di sega circolare per lo strumento multi-funzione HCS
 E Hoja redonda HCS para herramienta multifuncional
 CN 高碳钢扇形锯片



88 mm

HCS

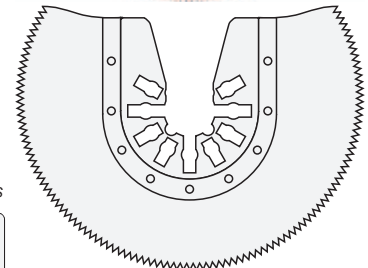

- application: wood, plastic, soft metal, plaster
- zastosowanie: drewno, plastik, miękki metal, gips

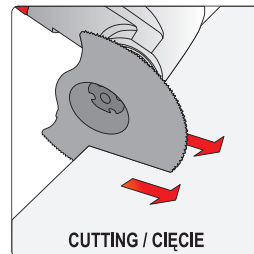

CUTTING / CIĘCIE

for / dla: YT-82220

DOUBLE BLISTER

YATO
YT-34681

5/100

- GB Brazed carbide d-shape blade for oscillating multitool HM
 D Rundes Sägeblatt HM für ein Multifunktionswerkzeug
 PL Brzeszczot okrągły HM do narzędzia wielofunkcyjnego
 RUS Дисковое полотно HM для многофункционального инструмента
 CZ Segmentový pilový list HM pro multifunkční nářadí
 H HM kör keresztmetszetű fűrészlap multifunkciós szerszámhoz
 RO Lamă rotundă HM pt. unealta multifuncțională
 F lame segment HM pour outil multifonction
 I Lama di sega circolare per lo strumento multi-funzione HM
 E Hoja redonda HM para herramienta multifuncional
 CN D形合金磨片

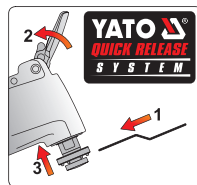

70 mm

HM

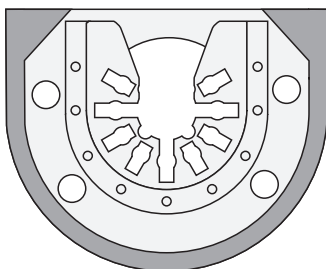

- application: concrete, ceramic materials, epoxy resin, fiberglass
- zastosowanie: beton, materiały ceramiczne, żywica epoksydowa, włókno szklane

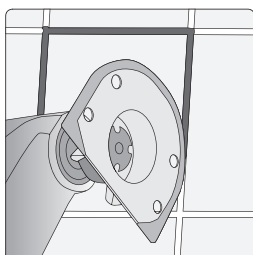

for / dla: YT-82220

DOUBLE BLISTER

YATO
YT-34682

5/100

- GB Plunge cutting saw blade for oscillating multitool BIM
 D Tiefenmesser BIM für ein Multifunktionswerkzeug
 PL Brzeszczot wglębny BIM do narzędzia wielofunkcyjnego
 RUS Сабельное полотно BIM для многофункционального инструмента
 CZ Pilový list BIM na ponorné řezy pro multifunkční nářadí
 H BIM merülő fűrészlap multifunkciós szerszámhoz
 RO Lamă de adâncime BIM pt. unealta multifuncțională
 F lame scie plongeante BIM pour outil multifonction
 I Lama per tagli dal pieno BIM
 E Hoja para cortes profundos BIM para herramienta multifuncional
 CN 双金属直锯片

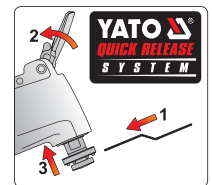

10 mm

BIM

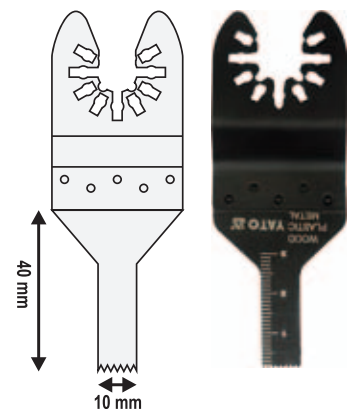

- application: wood, plastic, metal, plaster, epoxy resin
- zastosowanie: drewno, plastik, metal, gips, żywica epoksydowa

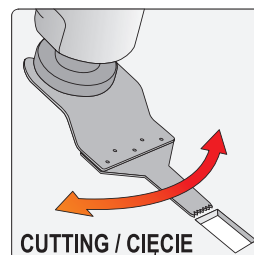

CUTTING / CIĘCIE

for / dla: YT-82220

DOUBLE BLISTER

YATO
YT-34683

5/100

GB Plunge cutting saw blade for oscillating multitool BIM
 D Tiefenmesser BIM für ein Multifunktionswerkzeug
 PL Brzeszczot węglenny BIM do narzędzia wielofunkcyjnego
 RUS Сабельное полотно BIM для многофункционального инструмента
 CZ Pilový list BIM na ponorné řezy pro multifunkční nářadí
 H BIM merülő fűrészlap multifunkciós szerszámhoz
 RO Lamă de adâncime BIM pt. unealta multifuncțională
 F Lame scie plongeante BIM pour outil multifonction
 I Lama per tagli dal pieno BIM
 E Hoja para cortes profundos BIM para herramienta multifuncional
 CN 双金属直锯片

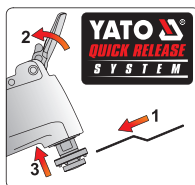

3
PCS

28.5
mm

BIM

- application: wood, plastic, metal, plaster, epoxy resin
- zastosowanie: drewno, plastik, metal, gips, żywica epoksydowa

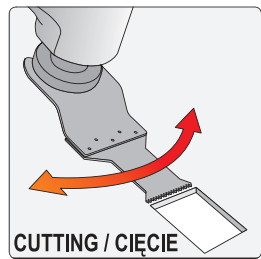
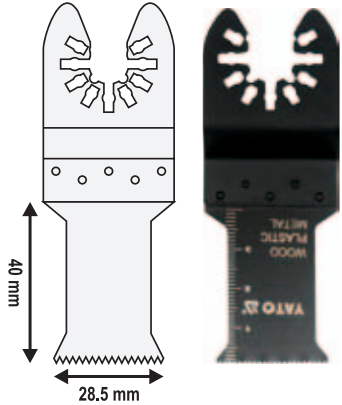

CUTTING / CIĘCIE

for / dla: YT-82220



YATO YT-34684 5/100

GB Plunge cutting saw blade for oscillating multitool HCS
 D Tiefenmesser HCS für ein Multifunktionswerkzeug
 PL Brzeszczot węglenny HCS do narzędzia wielofunkcyjnego
 RUS Сабельное полотно HCS для многофункционального инструмента
 CZ Pilový list HCS na ponorné řezy pro multifunkční nářadí
 H HCS merülő fűrészlap multifunkciós szerszámhoz
 RO Lamă de adâncime HCS pt. unealta multifuncțională
 F Lame scie plongeante HCS pour outil multifonction
 I Lama per tagli dal pieno HCS
 E Hoja para cortes profundos HCS para herramienta multifuncional
 CN 高碳钢直锯片

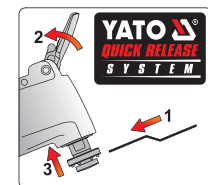

3
PCS

34
mm

HCS

- application: wood, plastic, plaster
- zastosowanie: drewno, plastik, gips

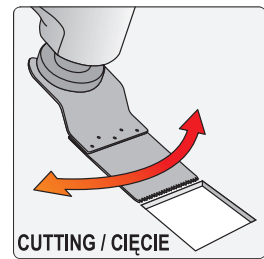
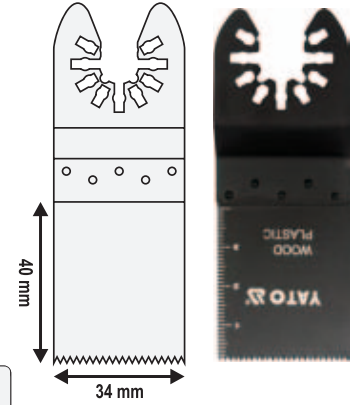

CUTTING / CIĘCIE

for / dla: YT-82220



YATO YT-34685 5/100

GB Plunge cutting saw blade for oscillating multitool BIM
 D Tiefenmesser BIM für ein Multifunktionswerkzeug
 PL Brzeszczot węglenny BIM do narzędzia wielofunkcyjnego
 RUS Сабельное полотно BIM для многофункционального инструмента
 CZ Pilový list BIM na ponorné řezy pro multifunkční nářadí
 H BIM merülő fűrészlap multifunkciós szerszámhoz
 RO Lamă de adâncime BIM pt. unealta multifuncțională
 F Lame scie plongeante BIM pour outil multifonction
 I Lama per tagli dal pieno BIM
 E Hoja para cortes profundos BIM para herramienta multifuncional
 CN 双金属直锯片

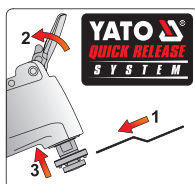

20
mm

BIM

- application: wood, plastic, metal, plaster, epoxy resin
- zastosowanie: drewno, plastik, metal, gips, żywica epoksydowa

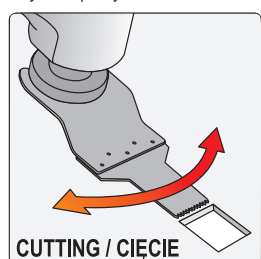
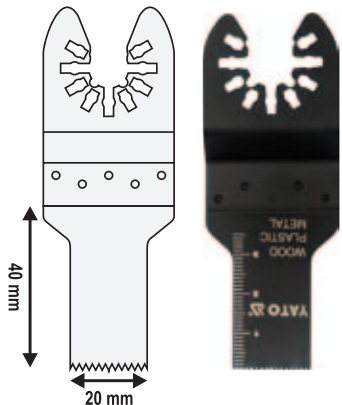

CUTTING / CIĘCIE

for / dla: YT-82220



YATO YT-34686 5/100

GB Brazed carbide triangular rasp for oscillating multitool
 D Dreieckige Raspel für ein Multifunktionswerkzeug
 PL Tamik trójkątny do narzędzia wielofunkcyjnego
 RUS Треугольный рашпиль для многофункционального инструмента
 CZ Trojúhelníková brusná deska pro multifunkční nářadí
 H Háromszög keresztmetszetű reszelő multifunkciós szerszámhoz
 RO Raspel triunghiular pt. unealta multifuncțională
 F Plateau de ponçage à concretion carbure pour outil multifonction
 I Raspa in metallo duro forma triangolare multi-funzione
 E Escofina triangular para herramienta multifuncional
 CN 三角形嵌合金磨片

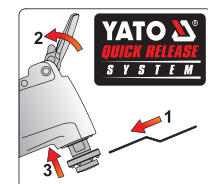

80
mm

HM

- application: concrete, ceramic materials
- zastosowanie: beton, materiały ceramiczne

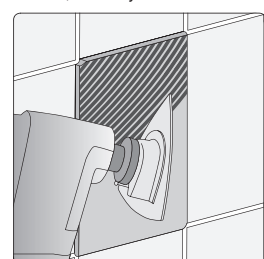
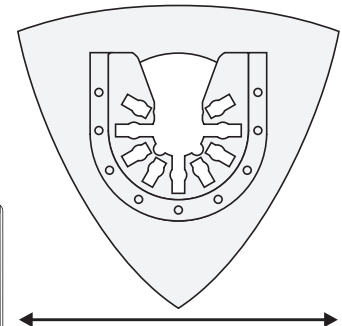

for / dla: YT-82220



YATO YT-34687 5/100

- GB Short scraper for oscillating multitool
D Schaber für ein Multifunktionswerkzeug
PL Skrobak do narzędzia wielofunkcyjnego
RUS Скребок для многофункционального инструмента
CZ Škrabka pro multifunkční nářadí
H Kaparó multifunkciós szerszámhoz
RO Răzuitor pt. unealta multifuncțională
F Spatule pour outil multifonction
I Raschietto oscillante multifunzione adatto
E Raspador para herramienta multifuncional
CN 弯刮刀

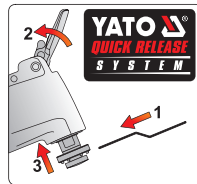

52 mm

HCS

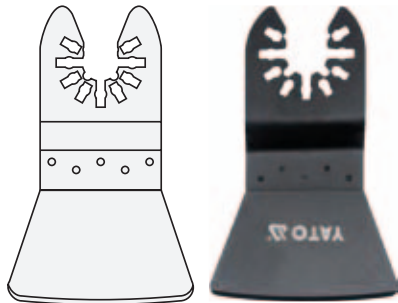

52 mm

for / dla: YT-82220

YATO
YT-34688

5/100

• application:
paint, adhesives,
sealing compounds

• zastosowanie:
farby, kleje, masy uszczelniające

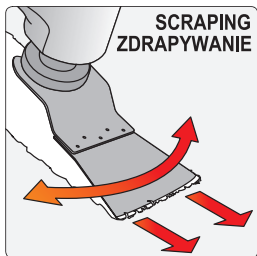

SCRAPING
ZDRAPYWANIE

DOUBLE
BLISTER

- GB Triangular eva sanding pad for oscillating multitool
D Schleiffuß für ein Multifunktionswerkzeug
PL Stopa szlifierska do narzędzia wielofunkcyjnego
RUS Шлифовальная насадка для многофункционального инструмента
CZ Brusný nástavec pro multifunkční nářadí
H Csiszoló talp multifunkciós szerszámhoz
RO Picior de sablare pt. unealta multifuncțională
F Plateau de ponçage pour outil multifonction
I Tasso di smerigliatrice multifunzionale
E Pie de rectificación para herramienta multifuncional
CN 三角砂盘

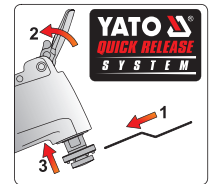

90 mm

EVA

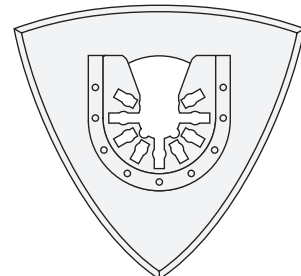

90 mm

for / dla: YT-82220

YATO
YT-34689

5/100

• application:
wood, metal, plaster

• zastosowanie:
drewno, metal, gips



SANDING / SZLIFOWANIE

DOUBLE
BLISTER

- GB Triangular sand paper for oscillating multitool
D Schleifpapier für ein Multifunktionswerkzeug
PL Papier ścienny do narzędzia wielofunkcyjnego
RUS Шлифовальная бумага для многофункционального инструмента
CZ Brusné plátno pro multifunkční nářadí
H Csiszolópapír multifunkciós szerszámhoz
RO Hârtie abrazivă pt. unealta multifuncțională
F Feuilles abrasives pour outil multifonction
I Carta abrasiva per utensile multifunzione
E Papel de lija para herramienta multifuncional
CN 三角砂纸

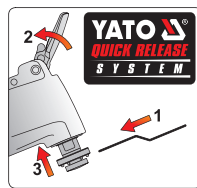

10 mm

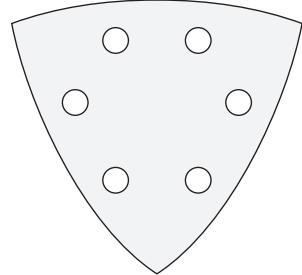

90 mm

for / dla: YT-82220

YATO
YT-34690

5/100

• application:
wood, metal, plaster

• zastosowanie:
drewno, metal, gips



SANDING / SZLIFOWANIE

DOUBLE
BLISTER

- GB Accessories set for oscillating multitool
D Zubehörsatz für ein Multifunktionswerkzeug
PL Zestaw akcesoriów do narzędzia wielofunkcyjnego
RUS Набор принадлежностей для многофункционального инструмента
CZ Souprava příslušenství pro multifunkční nářadí
H Tartozék szett multifunkciós szerszámhoz
RO Set de accesorii pt. unealta multifuncțională
F Set d'accessoires pour outil multifonction
I Set di accessori per utensile multifunzione
E Juego de accesorios para herramienta multifuncional
CN 三件套：双金属直锯片 + 高碳钢直锯片 + 高速钢半圆形锯片

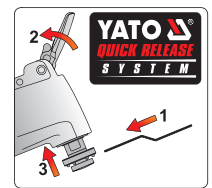

3 PCS
HSS

HCS
BIM

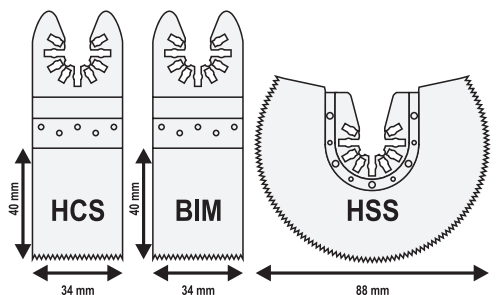

• application:
wood, plastic,
metal, plaster,
epoxy resin

• zastosowanie:
drewno, plastik,
metal, gips,
żywica epoksydowa

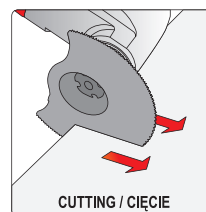

CUTTING / CIĘCIE

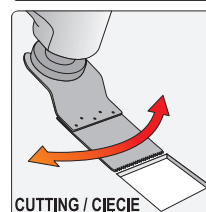

CUTTING / CIĘCIE



DOUBLE
BLISTER

for / dla: YT-82220

YATO
YT-34691

5/100

GB Steel wire brush
 D Stahldrahtbürste
 PL Szczotka druciana
 RUS Щетка стальная

CZ Drátěný kartáč
 H Drótkefe
 RO Perie de sârmă

F Brosse de fil en laiton
 I Spazzola metallica

E Cepillo de acero
 CN 钢丝刷

ZINC
PLATED
WIRES



YATO	rows / rzędy	
YT-6353	3	12/120
YT-6354	4	12/120
YT-6355	5	12/120
YT-6356	6	12/120

YATO	rows / rzędy	
YT-6358	4	12/72
YT-6359	5	12/72
YT-6360	6	12/72

GB Steel wire brush
 D Stahldrahtbürste
 PL Szczotka drucziana
 RUS Щетка стальная

CZ Drátěný kartáč
 H Drótkefe
 RO Perie de sârmă

F Brosse de fil en laiton
 I Spazzola metallica

E Cepillo de acero
 CN 钢丝刷

TIED
ON CARD



STEEL
STAL

STEEL
STAL

YATO	rows / rzędy	L (mm)	
YT-6330	3	340	12/72

YATO	rows / rzędy	L (mm)	
YT-6331	3	340	12/72

10



STEEL
STAL

STEEL
STAL

YATO	rows / rzędy	L (mm)	
YT-6332	4	260	12/72

YATO	rows / rzędy	L (mm)	
YT-6333	4	290	12/72

STEEL
STAL

STAINLESS
STEEL
STAL
NIEKORZYŻNA

YATO	rows / rzędy	L (mm)	
YT-6334	6	180x65	12/60

YATO	rows / rzędy	L (mm)	
YT-6335	3	340	12/72

STAINLESS
STEEL
STAL
NIEKORZYŻNA

STAINLESS
STEEL
STAL
NIEKORZYŻNA

YATO	rows / rzędy	L (mm)	
YT-6336	3	340	12/72

YATO	rows / rzędy	L (mm)	
YT-6337	3	180	24/144

STAINLESS
STEEL
STAL
NIEKORZYŻNA

STAINLESS
STEEL
STAL
NIEKORZYŻNA

YATO	rows / rzędy	L (mm)	
YT-6338	4	260	12/72

YATO	rows / rzędy	L (mm)	
YT-6339	4	290	12/72

GB Steel wire brush
D Stahldrahtbürste
PL Szczotka druciana
RUS Щетка стальная

CZ Drátěný kartáč
H Drótkefe
RO Perie de sârmă

F Brosse de fil en laiton
I Spazzola metallica
E Cepillo de acero
CN 钢丝刷

TIED
ON CARD

STAINLESS
STEEL
STAL
NERDZEWA



YATO	rows / rzędy	L (mm)	
YT-6340	5	180	24/120

BRASS
MOSIĄDZ



YATO	rows / rzędy	L (mm)	
YT-6341	3	340	12/72

BRASS
MOSIĄDZ



YATO	rows / rzędy	L (mm)	
YT-6342	3	340	12/72

BRASS
MOSIĄDZ



YATO	rows / rzędy	L (mm)	
YT-6343	3	180	24/144

BRASS
MOSIĄDZ



YATO	rows / rzędy	L (mm)	
YT-6344	4	260	12/72

BRASS
MOSIĄDZ



YATO	rows / rzędy	L (mm)	
YT-6345	4	290	12/72

BRASS
MOSIĄDZ



YATO	rows / rzędy	L (mm)	
YT-6346	5	180	24/120

NYLON



YATO	rows / rzędy	L (mm)	
YT-6348	4	290	12/72

NYLON



YATO	rows / rzędy	L (mm)	
YT-6349	5	180	24/120

NYLON



YATO	rows / rzędy	L (mm)	
YT-6350	6	180x65	12/60

GB Plastic handle wire brush set
D Bürstensatz
PL Komplet szczotek drucianych
RUS Щетки - набор
CZ Drátěný kartáče
H Kefekészlet
RO Perii
F Set de broșes de fil en laiton

I Set di spazzole metalliche
E Juego de 3 cepillos
CN 钢丝刷组套

3
PCS

STAINLESS
STEEL
STAL
NERDZEWA

BRASS
MOSIĄDZ

NYLON



SLIDING
CARD

YATO	rows / rzędy	L (mm)	
YT-6351	3	180	24/144

- GB Wire brush set
- D Bürsten Sortiment
- PL Zestaw szczotek do gniazd wtryskiwaczy
- RUS Ерши с наружной резьбой в наборе
- CZ Rourové kartáče válcové
- H Henger drótkefe
- RO Perii cilindrice pt. curatarea gaurilor
- F Brosse cylindrique
- I Vetro di protezione
- E Cepillos para limpieza interior
- CN 件套清洁组

20 PCS	150 mm	1/4" 6.3mm	9,11,13 15,17,19 mm
NYLON	STAINLESS STEEL STAL NEROZEWNA	BRASS MOSIADZ	



NYLON CASE & COLOR BOX

YATO		
YT-08195		24

- GB Copper pipe internal brush
- D Kupferrohr Innenbürste
- PL Szczotka wewnętrzna do rur miedzianych
- RUS Щетка для внутренней очистки труб
- CZ Kartáč vnitřní na měděné trubky
- H Rézcső belső tisztító kefe
- RO Perii de interior pt. tevi de cupru
- F Brosse aux tubes en cuivre
- I Spazzola per il rame interno
- E Cepillo para limpieza de tubos de cobre
- CN 管子刷



STAINLESS
STEEL WIRE
DRUJ ZE STALI
NEROZEWNEJ

YATO	Ø (mm)	
YT-63701	15	12/120
YT-63702	18	12/120
YT-63703	22	12/120
YT-63704	28	12/120

- GB Copper pipe brush 2 in 1
- D 2-in-1 Kupferrohrbürste für Innen- und Außenreinigung
- PL Szczotka do rur miedzianych 2 w 1
- RUS Щетка для внутренней и внешней зачистки медных труб
- CZ Kartáč vnitřní a vnější na měděné trubky
- H Rézcső tisztító kefe 2 in 1
- RO Perii pt. tevi de cupru 2 in 1
- F Brosse aux tubes en cuivre
- I Spazzola per il tubi di rame 2 in 1
- E 2-en-1 cepillo para limpieza de tubos de cobre int. y ext
- CN 2合1管子刷



STAINLESS
STEEL WIRE
DRUJ ZE STALI
NEROZEWNEJ

SLIDING
CARD

YATO	Ø (mm)	
YT-63705	15: 22	50/100

- GB Cleaning pad set for copper pipes
- D Reinigungsvlies-satz für kupferrohre
- PL Włóknina do czyszczenia rur miedzianych
- RUS Губка абразивная
- CZ Brusné rouno
- H Tisztítószivacs
- RO Burete abraziv
- F Tampons de nettoyage
- I Fibra abrasiva per la pulizia de tubo di rame
- E Almohadilla abrasiva
- CN 件套工业洁

10 PCS	75x130 mm	FOR PIPES DO RUR Cu	METAL FREE NIE ZAWIERA METALU	DRY WORK PRACA NA SUCHO	WET WORK PRACA NA MOKRO
------------------	---------------------	----------------------------------	--	-------------------------------	-------------------------------

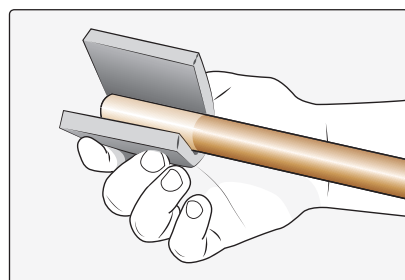

COLOR
SLEEVE

YATO	size / rozmiar (mm)	
YT-63740	75x130	50

GB Cup brush with shaft
D Stahldraht-Topfbürste
PL Szczotka czolowa z trzpieniem
RUS Щетка "чашка" со стержнем
CZ Čelní kartáč drátěný se stopkou
H Homlok drótkefe, nyéllel
RO Perie frontală pt. bormasina
F Brosse coupe avec goupille
I Spazzola a tazza
E Cepillo de copa con mandril
CN 钢丝轮

SLIDING
CARD



INOX



YATO	Ø (mm)	R.P.M.max.	Box
YT-4750	75	4500	12/96

YATO	Ø (mm)	R.P.M.max.	Box
YT-4751	75	4500	12/96

YATO	Ø (mm)	R.P.M.max.	Box
YT-4752	75	6000	12/72

GB Cup brush with shaft set
D Drahtbürste mit Einspannschaft
PL Szczotki druciane z trzpieniem
RUS Щетки проволочные со стержнем
CZ Drátěný kartáč se stopkou
H Drótkefe, csapos
RO Perie de sârmă cu tijă
F Set de brosses coupe avec goupille
I Spazzola metallica a disco
E Cepillos de alambre con espiga
CN 三件钢丝组套



SLIDING
CARD



YATO	Ø (mm)	R.P.M.max.	Box
YT-4755	20	6000	12/60
	50	7500	
	50	4500	

GB Circular brush with shaft
D Stahlbraht-Scheibenbürste
PL Szczotka tarczowa z trzpieniem
RUS Щетка круговая со стержнем
CZ Okružní kartáč drátěný se stopkou
H Tarcás drótkefe, nyéllel
RO Perie rotundă pt. bormasina
F Brosse circulaire avec goupille
I Spazzola a disco
E Cepillo redondo
CN 钢丝轮

SLIDING
CARD



INOX

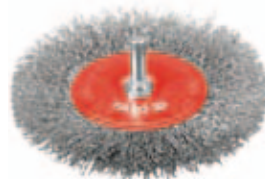

YATO	Ø (mm)	R.P.M.max.	Box
YT-4757	100	4500	12/96

YATO	Ø (mm)	R.P.M.max.	Box
YT-4758	100	4500	12/96

YATO	Ø (mm)	R.P.M.max.	Box
YT-4759	75	20000	10/100

GB Circular brush
D Stahlbraht-Scheibenbürste
PL Szczotka tarczowa z gwintem
RUS Щетка круговая
CZ Okružní kartáč drátěný
H Tarcás drótkefe
RO Perie rotundă pt. bormasina
F Brosse circulaire avec filet
I Spazzola conica
E Cepillo redondo
CN 钢丝轮

COLOR
BOX



M14



INOX



YATO	Ø (mm)	R.P.M.max.	Box
YT-4761	100	12500	8/64

YATO	Ø (mm)	R.P.M.max.	Box
YT-4763	100	12500	8/64

YATO	Ø (mm)	R.P.M.max.	Box
YT-4764	125	10000	8/48

GB Cup brush
D Stahlbraht-Topfbürste
PL Szczotka czolowa z gwintem
RUS Щетка "чашка"
CZ Čelní kartáč drátěný
H Homlok drótkefe
RO Perie frontală
F Brosse coupe avec filet
I Spazzola conica
E Cepillo de copa
CN 钢丝轮

COLOR
BOX



M14



INOX



YATO	Ø (mm)	R.P.M.max.	Box
YT-4766	100	8500	4/32

YATO	Ø (mm)	R.P.M.max.	Box
YT-4767	60	12500	10/80

YATO	Ø (mm)	R.P.M.max.	Box
YT-4768	75	11000	6/36

YATO	Ø (mm)	R.P.M.max.	Box
YT-4769	100	8500	4/16

GB Insulated cable knife
D Kabelmesser gerade
PL Nóż dla elektryków izolowany
RUS Нож кабельный изолированный
CZ Izolovaný nůž
H Szerelőkés

RO Cutit pt. cabluri izolat
F Couteau d'électricien
I Coltello per elettricisti isolato
E Cuchillo electricista aislante
CN 绝缘电工刀

180 mm
50 mm
65 Mn
1000 V
D'E



1000V VDE CERTIFICATE EN 60900:2012

YATO	L (mm)	
YT-21210	180	6/72

GB Insulated dismantling knife
D Abmantelungsmesser
PL Nóż demontażowy dla elektryków
RUS Нож кабельный изолированный
CZ Zahnutý nůž s vodítkem, izolovaný

H Szerelőkés
RO Cutit demontabil izolat
F Couteau d'électricien
I Coltello di smontaggio per elettricisti isolati
E Cuchillo de desmontaje aislante
CN 绝缘电工刀

155 mm
38 mm
65 Mn
1000 V
D'E



1000V VDE CERTIFICATE EN 60900:2012

YATO	L (mm)	
YT-21211	155	6/72

GB Electrician's knife
D Montagemesser
PL Nóż składany monterski
RUS Нож складной

CZ Montážní nůž
H Szerelőkés
RO Cuțit pt. decablat
F Couteau d'électricien

I Coltello
E Cuchillo de montaje
CN 电工刀

SLIDING CARD



3CR13 HRC 42-48

85 mm
200 mm



YATO	L (mm)	
YT-7600	200	6/96

75 mm
190 mm



YATO	L (mm)	
YT-7601	190	6/96

GB Folding knife with bits
D Klappmesser
PL Nóż składany z bitami
RUS Нож складной
CZ Kapesní nůž

H Zsebkés
RO Briceag
F Couteau pince multifonction avec embouts

I Coltello pieghevole con punte
E Navaja
CN 旋具头折叠刀

BLISTER CARD



STAINLESS STEEL STAL NIERDZEWNA
AI
-+T10, T20



3, 4 mm; PH1, PH2; T10, T20

YATO		
YT-76031		6/48

GB Folding knife
D Klappmesser
PL Nóż składany
RUS Нож складной

CZ Kapesní nůž
H Zsebkés
RO Briceag
F Couteau pliant

I Coltello pieghevole
E Navaja
CN 折叠刀

SLIDING CARD



STAINLESS STEEL BLADE OSTRZE ZE STALI NIERDZEWNEJ

AI



YATO		
YT-76050		12/72



YATO		
YT-76051		12/120



YATO		
YT-76052		6/48

- GB Multi knife
D Klappmesser
PL Nóż wielofunkcyjny
RUS Нож складной
CZ Kapesní nůž
H Zsebkés
RO Briceag
- F Couteau multifonction
I Pinze universale
E Navaja
CN 多功能折叠刀

7 PCS
STAINLESS STEEL
STAL
NIEŹYWIENNA
AI



SLIDING CARD

YATO  YT-76030  12/96

- GB Multi knife
D Klappmesser
PL Narzędzie wielofunkcyjne
RUS Нож складной
- CZ Kapesní nůž
H Zsebkés
RO Briceag
F Couteau pince multifonction
- I Pinze universale
E Navaja
CN 多功能折叠刀

BLISTER CARD



9 PCS

STAINLESS STEEL
STAL
NIEŹYWIENNA



AI

YATO  YT-76040  10/100





AI

YATO  YT-76041  12/48



AI

YATO  YT-76042  12/48



YATO  YT-76043  6/36

- GB Cutter knife
 D Universalmesser
 PL Nożyk z ostrzem trapezowym
 RUS Ножи универсальные
 CZ Univerzální nůž
 H Univerzális kés
 RO Cuțit universal
- F Couteau lames trapésoïdale
 I Coltellino con lama trapezoidale
 E Cutter con filo trapezoidal
 CN 实用刀

SK5



x3

TRY ME DOUBLE BLISTER

YATO	(mm)	
YT-7520	61x33x0.5	6/48



x5

DOUBLE BLISTER

YATO	(mm)	
YT-7532	61x33x0.5	12/72



x5

DOUBLE BLISTER

YATO	(mm)	
YT-7534	61x33x0.5	12/72

- GB Utility knife
 D Universalmesser
 PL Nożyk z łamanym ostrzem
 RUS Нож универсальный
 CZ Nůž na tapety
 H Tapétaolló
- RO Cuțitaș pt. tapet
 F Cutter à lames sécables
 I Taglierino
 E Cuchillo para papel de empapelar
 CN 美工刀

SLIDING CARD

SK5



- GB Cutter knife
 D Universalmesser
 PL Nożyk z ostrzem trapezowym
 RUS Ножи универсальные
 CZ Univerzální nůž
 H Univerzális kés
 RO Cuțit universal
 F Couteau lames trapésoïdale
- I Coltellino con lama trapezoidale
 E Cutter con filo trapezoidal
 CN 实用刀

SLIDING CARD

61x33x0.5 mm

SK5

LOCK BLOKADA

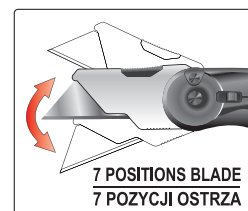

AI

YATO	(mm)	
YT-76060	61x33x0.5	6/48



YATO	(mm)	
YT-76061	61x33x0.5	6/48

x3

AI HANDLE



YATO	(mm)	
YT-7571	9x0.4	20/80
YT-7581	18x0.4	20/80

x5

LOCK BLOKADA



YATO	(mm)	
YT-7501	18x0.4	12/120

x3

LOCK BLOKADA



YATO	(mm)	
YT-7510	25x0.7	6/48

- GB Utility knife
D Universalmesser
PL Nożyk z lamany ostrzem
RUS Нож универсальный
CZ Nůž na tapety
H Tapétaolló
- RO Cuțitaș pt. tapet
F Cutter à lames sécables
I Taglierino
E Cuchillo para papel de empapelar
CN 美工刀

SLIDING CARD



SK2



YATO	(mm)	
YT-7511	9x0.4	24/288
YT-7512	18x0.5	12/96



LOCK ABS TPR

YATO	(mm)	
YT-7506	9x0.4	24/240
YT-7507	18x0.5	12/144



ABS

YATO	(mm)	
YT-7504	9x0.4	24/240
YT-7505	18x0.5	24/240



X3 LOCK BLOKADA ABS TPR

YATO	(mm)	
YT-7503	18x0.5	12/144

- GB Electrician scissors
D Elektrische Schere
PL Nożyczki dla elektryków
RUS Ножницы универсальные
CZ Elektrické nůžky
H Unverzális olló
- RO Foarfece - electrician
F Ciseaux pour electriciens
I Forbici per elettricisti
E Tijeras eléctricos
CN 电工剪

140 mm STAINLESS STEEL / STAL NIERDZEWNA HRC 52-56



SLIDING CARD

YATO	L (mm)	
YT-1974	140	12/120

- GB Spare blades
D Abbrechklingen
PL Ostrza zapasowe
RUS Лезвия для универсальных ножей
CZ Lomené ostří náhradní
H Törhető tartalékpenge
- RO Lame de rezervă rupte
F Lame sécables pour le cutter
I Lame di ricambio
E Filo partido de recambio
CN 美工刀刀片

PLASTIC BOX & SLIDING CARD



10 PCS

SK5

YATO	(mm)	
YT-7530	25x0.7	6/48

YATO	(mm)	
YT-7531	61x33x0.5	24/144

YATO	(mm)	
YT-7528	9x0.4	24/144
YT-7529	18x0.5	24/144

YATO	(mm)	
YT-7528	9x0.4	24/144
YT-7529	18x0.5	24/144

- GB Spare blades
D Abbrechklingen
PL Ostrza zapasowe
RUS Лезвия для универсальных ножей
CZ Lomené ostří náhradní
H Törhető tartalékpenge
- RO Lame de rezervă rupte
F Lame sécables pour le cutter
I Lame di ricambio
E Filo partido de recambio
CN 美工刀刀片

PLASTIC BOX & SLIDING CARD

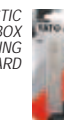

10 PCS

SK2

YATO	(mm)	
YT-7524	9x0.4	24/240
YT-7525	18x0.5	24/144

YATO	(mm)	
YT-7527	61x33x0.5	24/144

- GB Insulated electrician scissors
D Elektrische Schere
PL Nożyczki dla elektryków izolowane
RUS Ножницы диэлектрические универсальные
CZ Elektrické nůžky
- H Unverzális olló
RO Foarfece - electrician izolate
F Ciseaux pour electriciens isolowane
I Forbici per elettricisti
E Tijeras eléctricos universales
CN 绝缘电工剪

160 mm CrV

1000 V D'E



1000V VDE CERTIFICATE EN 60900:2012

YATO	L (mm)	
YT-21200	160	6/48

- GB Scissors
D Haushaltsschere
PL Nożyczki
RUS Ножницы
CZ Nůžky
H Olló
- RO Foarfece
F Ciseaux
I Forbici
E Tijeras
CN 剪刀

STAINLESS STEEL BLADE / OSTRZE ZE STALI NIERDZEWNA



SLIDING CARD

YATO	L (mm)	
YT-19763	170	12/120
YT-19764	190	12/120
YT-19765	215	12/120
YT-19766	245	12/120
YT-19767	300	12/120

- GB Glass oil cutter
 D Glasschneider
 PL Nóż olejowy do szkła
 RUS Стеклопerez масляный
 CZ Rezák na sklo
- H Olajkés üveghez
 RO Diamant pt. taiat stricla cu ulei
 F Couteau à l'huile pour verre
 I Taglia vetro con serbatoio olio
- E Cuchillo de aceite para cristalinacion
 CN 玻璃割刀

SLIDING CARD



YD05
 TUNGSTEN CARBIDE TIP
 OSTRZE Z WĘGLIKA
 WOLFRAMU

HRA
 92.5-93



YATO	L (mm)	
YT-7560	177	6/120

YATO	L (mm)	
YT-7561	178	6/120

- GB Scriber for glass, ceramics and metal
 D Reißnadel für Glas, Keramik und Metall
 PL Rysik do szkła, ceramiki i metalu
 RUS Штихель для стекла, керамика и металла
- CZ Rýsovací jehla na sklo, keramiku a kov
 H Karctű üveghez, kerámiához és fémhez
 RO Ac de trasat pt. sticlă, ceramică și metal
 F Stylet verre, céramique et métal
- I Penna di vetro ceramica metallo
 E Trazador para vidrio, cerámica y metal
 CN 划线器

SLIDING CARD



140 mm

YG6X
 TUNGSTEN CARBIDE TIP
 OSTRZE Z WĘGLIKA
 WOLFRAMU



YATO	L (mm)	
YT-3740	140	6/240

- GB Double edge trimmer
 D Kantentrimmer
 PL Dwustronny nóż do odcinania oklein
 RUS Двусторонний нож для мебельной пленки
 CZ Orezávací nuž na hrany lamina
 H Kétélű vágó
- RO Rindea pt. finisaje
 F Couteau reversible pour bois de placage
 I Doppio coltello
 E Cuchillo de doble filo para cortar chapas de madera
 CN 双边刨子

13-25 mm

ONE SIDE CUTTING
 BOTH SIDE CUTTING

SK5



SLIDING CARD



YATO	
YT-5710	6/48



- GB Profile gauge
 D Profilmuster
 PL Wzornik profili
- RUS Шаблон профилей
 CZ Profilová šablona
 H Profilsablon
- RO Șablon profile
 F Jauges d'épaisseurs métriques
- I Profilato
 E Plantilla de perfiles
 CN 轮廓仪

SLIDING CARD



44 mm

1.5 mm



YATO	L (mm)	
YT-3735	125	24/72

YATO	L (mm)	
YT-3736	260	10/40

- GB Punch set
 D Lederlocherset
 PL Przebijaki do skóry
 RUS Набор пробойников для кожи
 CZ Sada průbojníků na kůži
 H Bőryukasztó készlet
 RO Set producele
 F Kit de perçoirs à cuir
 I Set di punzoni
 E Juego de perforar en piel
 CN 冲孔器套装



POUCH & COLOR BOX



9
 PCS

15
 PCS

YATO	size / rozmiar	
YT-3590	2.5; 3.0; 4.0; 5.0; 6.0; 7.0; 8.0; 9.0; 10.0	50

YATO	size / rozmiar	
YT-3591	2.0; 2.5; 3.2; 4.0; 4.8; 5.5; 6.4; 8.0; 9.5; 11.1; 12.7; 14.0; 15.8; 19.0; 22.0	10

- GB PVC pipe cutter
- D PVC Rohrabsschneider
- PL Obcinak do rur PCV
- RUS Труборез для ПВХ труб
- CZ Řezač PVC trubek
- H Csővágó olló PVC csövekhez
- RO Clește pt. tăiat țevi din PVC
- F Coupeur aux tubes
- I Taglia tubi PVC
- E Cortatubos PVC
- CN PVC 管子割刀



∅ max (mm) 35	PEX AL PEX	PVC PP PU PE	8Cr13 STAINLESS STEEL STAL NIERZĘDZWA	HRC 54
-------------------------	------------------	-----------------------	---	------------------

SLIDING
CARD

YATO	max. ∅ (mm)	
YT-2230	35	6/48

- GB PVC pipe cutter
- D PVC Rohrabsschneider
- PL Obcinak do rur PCV
- RUS Труборез для ПВХ труб
- CZ Řezač PVC trubek
- H Csővágó olló PVC csövekhez
- RO Clește pt. tăiat țevi din PVC
- F Coupeur aux tubes
- I Taglia tubi PVC
- E Cortatubos PVC
- CN PVC 管子割刀



∅ max (mm) 42	PEX AL PEX	PVC PP PU PE	8Cr13 STAINLESS STEEL STAL NIERZĘDZWA	HRC 54	RATCHET SYSTEM ZAPADKOWY	QUICK RELEASE SZYBKIE ZWALNIANIE
-------------------------	------------------	-----------------------	---	------------------	--------------------------------	---

SLIDING
CARD

YATO	max. ∅ (mm)	
YT-2231	42	6/48

- GB PVC pipe cutter
- D PVC Rohrabsschneider
- PL Obcinak do rur PCV
- RUS Труборез для ПВХ труб
- CZ Řezač PVC trubek
- H Csővágó olló PVC csövekhez
- RO Clește pt. tăiat țevi din PVC
- F Coupeur aux tubes
- I Taglia tubi PVC
- E Cortatubos PVC
- CN PVC 管子割刀



∅ max (mm) 63	PEX AL PEX	PVC PP PU PE	8Cr13 STAINLESS STEEL STAL NIERZĘDZWA	HRC 56-58	RATCHET SYSTEM ZAPADKOWY	QUICK RELEASE SZYBKIE ZWALNIANIE
-------------------------	------------------	-----------------------	---	---------------------	--------------------------------	---

SLIDING
CARD

YATO	max. ∅ (mm)	
YT-22312	63	6/24

- GB PVC pipe cutter
- D PVC Rohrabsschneider
- PL Obcinak do rur PCV
- RUS Труборез для ПВХ труб
- CZ Řezač PVC trubek
- H Csővágó olló PVC csövekhez
- RO Clește pt. tăiat țevi din PVC
- F Coupeur aux tubes
- I Taglia tubi PVC
- E Cortatubos PVC
- CN PVC 管子割刀



SLIDING
CARD

PEX AL PEX	PVC PP PU PE	8Cr13 STAINLESS STEEL STAL NIERZĘDZWA	HRC 54
AI	RATCHET SYSTEM ZAPADKOWY	QUICK RELEASE SZYBKIE ZWALNIANIE	

∅ max (mm) 51

YATO	max. ∅ (mm)	
YT-2228	51	6/24



∅ max (mm) 64

YATO	max. ∅ (mm)	
YT-2229	64	6/24

- GB Pipe cutter
- D Rohrabsschneider
- PL Obcinak do rur
- RUS Труборез для труб
- CZ Řezač trubek
- H Csővágó olló csövekhez
- RO Clește pt. tăiat țevi
- F Coupeurs aux tubes
- I Rullo di taglio per tubi
- E Cortatubos
- CN 管子割刀

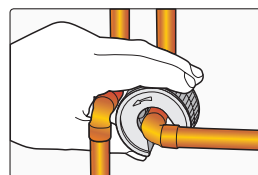

PEX	PLASTIC Al, Cu	BEARING STEEL STAL ŁOŻYSKOWA
-----	-------------------	---------------------------------

SLIDING
CARD

YATO	∅	external diameter / średnica zewnętrzna (mm)	
YT-22353	19/32" (15 mm)	48	10/100
YT-22354	23/32" (18 mm)	59	10/50
YT-22355	7/8" (22 mm)	56	10/50

GB Pipe cutter
 D Rohrschneider
 PL Obcinak do rur
 RUS Труборіз для труб

CZ Řezač trubek
 H Csővágó olló
 RO Clește pt. tăiat țevi

F Coupeur aux tubes
 I Taglia tubi PVC
 E Cortatubos
 CN 管子割刀

COLOR BOX



PEX



PLASTIC Al, Cu
 Ø 1/10"-7/8"
 Ø 3-22 mm

BEARING STEEL STAL ŁOŻYSKOWA

YATO	Ø	
YT-22318	1/10"-7/8" (3-22 mm)	100



PLASTIC Al, Cu
 Ø 1/10"-5/4"
 Ø 3-32 mm

QUICK-ADJUSTMENT SZYBKONASTAWNY

WITH DEBURRER Z GRATOWNIKIEM

BEARING STEEL STAL ŁOŻYSKOWA

SPARE CUTTING WHEEL ZAPASOWE KÓŁKO TNĄCE

YATO	Ø	
YT-22338	1/10"-5/4" (3-32 mm)	50



PLASTIC Al, Cu
 Ø 3/8"-1-5/8"
 Ø 10-40 mm

BEARING STEEL STAL ŁOŻYSKOWA

YATO	Ø	
YT-2232	3/8"-1-5/8" (10-40 mm)	20



PLASTIC Al, Cu
 Ø 1/4"-7/4"
 Ø 6-45 mm

WITH DEBURRER Z GRATOWNIKIEM

BEARING STEEL STAL ŁOŻYSKOWA

SPARE CUTTING WHEEL ZAPASOWE KÓŁKO TNĄCE

YATO	Ø	
YT-2233	1/4"-7/4" (6-45 mm)	25



PLASTIC Al, Cu
 Ø 1/2"-5/2"
 Ø 14-63 mm

QUICK-ADJUSTMENT SZYBKONASTAWNY

BEARING STEEL STAL ŁOŻYSKOWA

SPARE CUTTING WHEEL ZAPASOWE KÓŁKO TNĄCE

YATO	Ø	
YT-2234	1/2"-5/2" (14-63 mm)	25



PLASTIC Al, Cu
 Ø 2"-5"
 Ø 50-127 mm

QUICK-ADJUSTMENT SZYBKONASTAWNY

BEARING STEEL STAL ŁOŻYSKOWA

YATO	Ø	
YT-2235	2"-5" (50-127 mm)	10

GB Replacement cutting wheel for pipe cutters
 D Ersatzschneidrad für Rohrschneider
 PL Zapasowe kółko tnące do obcinaka do rur
 RUS Запасной режущий диск для труборезов
 CZ Náhradní řezné kolečko na trubky frézy

H Tartalék vágókerék cső vágó
 RO Roata de schimb pt. taiere țevi
 F Molette pour coupe
 I Taglio ruote tubo taglierina
 E Rueda de corte de repuesto para cortatubos
 CN 管子割刀刀片

2 PCS
 BEARING STEEL STAL ŁOŻYSKOWA

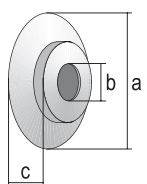

DOUBLE BLISTER

YATO	a (mm)	b (mm)	c (mm)	for/dla:	
YT-22313	18	6	4.8	YT-2233	50/300
YT-22314	26	14	7.5	YT-2232	6/108
YT-22315	18	6	4.8	YT-22338	50/300
YT-22316	27	6.3	5	YT-2234	24/288

GB Replacement cutting wheel for pipe cutters
 D Ersatzschneidrad für Rohrschneider
 PL Zapasowe kółko tnące do obcinaka do rur
 RUS Запасной режущий диск для труборезов
 CZ Náhradní řezné kolečko na trubky frézy

H Tartalék vágókerék cső vágó
 RO Roata de schimb pt. taiere țevi
 F Molette pour coupe
 I Taglio ruote tubo taglierina
 E Rueda de corte de repuesto para cortatubos
 CN 管子割刀刀片

BEARING STEEL STAL ŁOŻYSKOWA

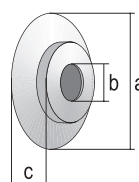

DOUBLE BLISTER

YATO	a (mm)	b (mm)	c (mm)	for/dla:	
YT-22317	44	10.6	8	YT-2235	12/144

- GB Window scraper CZ Škrábák na skla I Coltellino con
D Fensterabstreicher H Kaparó üveghez lama trapezoidale
PL Skrobak do szyb RO Răzuitor pt. geamuri E Rascador de cristales
RUS Скребок для стекла F Gratte-givre CN 玻璃刮刀

HALF
DOUBLE
BLISTER





18x100
mm

SK5

ALUMINIUM



ABS



YATO 	L (mm)	
YT-7550	300	10/60



TELESCOPIC
HANDLE
390-600
mm

YATO 	L (mm)	
YT-7551	390-600	10/60

- GB Scraper RO Honuitor
D Ziehklinge F Racléuse métal
PL Cyklina I Raschietto
RUS Цикля E Raspador
CZ Škrabka na parkety CN 刮刀
H Simitógyalu



HALF
DOUBLE
BLISTER



TUNGSTEN
CARBIDE
WEGLIK
WOLFRAM





BLADE
 22mm

YATO 	L (mm)	
YT-5702	240	6/48





BLADE
 50mm

YATO 	L (mm)	
YT-5703	250	6/48



BLADE
 65mm

YATO 	L (mm)	
YT-5704	290	6/48

GB Steel file CZ Zámeňický pilník I Lime per metallo
 D Werkstatt-Feile H Lakatos reszelő E Lima para metal
 PL Pilnik do metalu RO Pila de lăcătușerie CN 锉
 RUS Напильник слесарный F Lime à métal

#1 #2 #3 T12 STEEL 150 mm 200 mm 250 mm 300 mm



YATO	#	L (mm)	
YT-62228	1	150	20/80
YT-62229	1	200	20/80
YT-6223	1	250	20/80
YT-62231	1	300	10/40
YT-6180	2	150	20/80
YT-6185	2	200	20/80
YT-6228	2	250	20/80
YT-6190	2	300	10/40
YT-62328	3	150	20/80
YT-62329	3	200	20/80
YT-6233	3	250	20/80
YT-62331	3	300	10/40



YATO	#	L (mm)	
YT-62238	1	150	20/80
YT-62239	1	200	20/80
YT-6224	1	250	20/80
YT-62241	1	300	20/80
YT-6181	2	150	20/80
YT-6186	2	200	20/80
YT-6229	2	250	20/80
YT-6191	2	300	10/40
YT-62243	3	150	20/80
YT-62244	3	200	20/80
YT-62245	3	250	20/80
YT-62246	3	300	10/40

YATO	#	L (mm)	
YT-62248	1	150	20/80
YT-62249	1	200	20/80
YT-6225	1	250	20/80
YT-62251	1	300	10/40
YT-6182	2	150	20/80
YT-6187	2	200	20/80
YT-6230	2	250	20/80
YT-6192	2	300	10/40
YT-62338	3	150	20/80
YT-62339	3	200	20/80
YT-6234	3	250	20/80
YT-62341	3	300	10/40



YATO	#	L (mm)	
YT-62258	1	150	20/80
YT-62259	1	200	20/80
YT-6226	1	250	20/80
YT-62261	1	300	10/40
YT-6183	2	150	20/80
YT-6188	2	200	20/80
YT-6231	2	250	20/80
YT-6193	2	300	10/40
YT-62348	3	150	20/80
YT-62349	3	200	20/80
YT-6235	3	250	20/80
YT-62351	3	300	10/40

YATO	#	L (mm)	
YT-62268	1	150	20/80
YT-62269	1	200	20/80
YT-6227	1	250	20/80
YT-62271	1	300	10/40
YT-6184	2	150	20/80
YT-6189	2	200	20/80
YT-6232	2	250	20/80
YT-6194	2	300	10/40
YT-62358	3	150	20/80
YT-62359	3	200	20/80
YT-6236	3	250	20/80
YT-62361	3	300	10/40

GB Steel file set CZ Zámeňické pilníky E Juego de limas para metal
 D Werkstatt-Feilen H Lakatos reszelő CN 锉组套
 PL Pilniki do metalu RO Pile de lăcătușerie
 RUS Набор напильников слесарных F Set de limes à métal I Lime per metallo

SLIDING CARD



#1 #2 #3 250 mm T12 STEEL

3
PCS

#2

#2

#2

YATO

YT-6237 10/20

5
PCS

#1 #2

#1

#1

#1

YATO

YT-6238 5/10

5
PCS

#3

#3

#3

#3

YATO

YT-6239 5/10

- GB Needle file set
D Nadelfeileinsatz
PL Zestaw pilników iglaków
RUS Набор напильников надфили
CZ Sada jehlových pilníku
H Túreszelő készlet
- RO Set pile conice
F Set de limes
I Set di lime e lime ad ago
E Juego de limas de aguja
CN 什锦锉组套

POUCH



GCR15
BEARING
STEEL



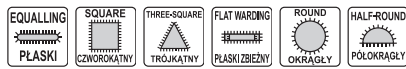

6
PCS

6
PCS



YATO 	working length / długość robocza (mm)	mm	
YT-6160	65	3x140	50/200

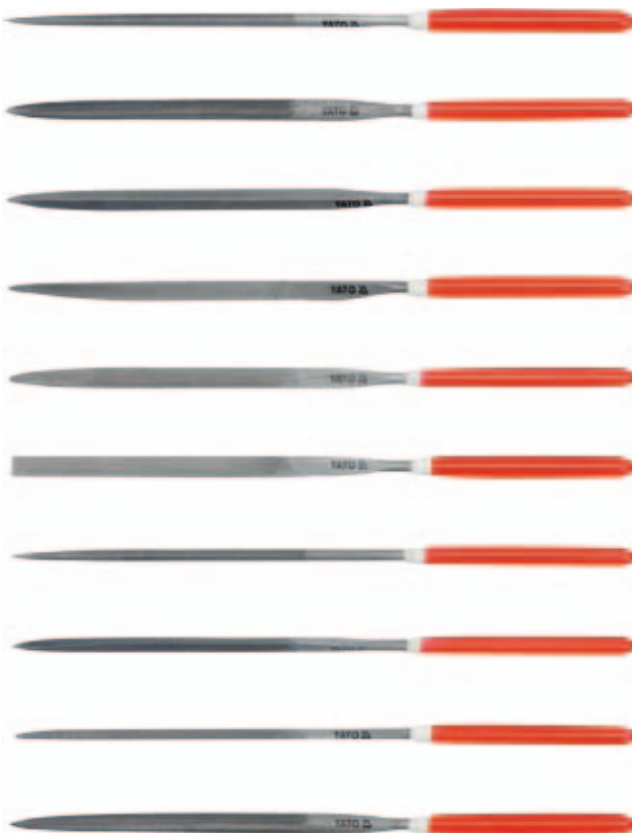

YATO 	working length / długość robocza (mm)	mm	
YT-6161	75	4x160	25/100
YT-6162	85	5x180	25/100



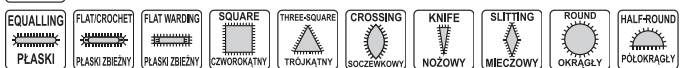

10
PCS

10
PCS



YATO 	working length / długość robocza (mm)	mm	
YT-6163	65	3x140	25/100

YATO 	working length / długość robocza (mm)	mm	
YT-6164	75	4x160	25/100
YT-6165	85	5x180	25/50

- GB Diamond needle file
 D Diamant-Nadelfeile
 PL Pilnik iglak diamentowy
 RUS Надфиль алмазный
- CZ Diamantový jehlový pilník
 H Gyémánt tűreszelő
 RO Pila diamentata
 F Lime diamant
- I Lime ad ago diamantate
 E Lima de aguja adiamantada
 CN 金刚石平头扁锉

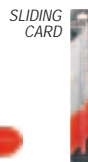

GRIT
ZIARNISTOŚĆ
150

YATO	grit / ziarnistość	coating length / długość nasypu (mm)	mm	
YT-6140	150	50	3x140	120/1200
YT-6147	150	50	4x160	80/800
YT-6152	150	70	5x180	45/450

YATO	grit / ziarnistość	coating length / długość nasypu (mm)	mm	
YT-6141	150	50	3x140	120/1200
YT-6148	150	50	4x160	80/800
YT-6153	150	70	5x180	45/450

YATO	grit / ziarnistość	coating length / długość nasypu (mm)	mm	
YT-6142	150	50	3x140	120/1200
YT-6149	150	50	4x160	80/800
YT-6154	150	70	5x180	45/450

- GB Diamond needle file set
 D Diamant-Nadelfeileinsatz
 PL Zestaw pilników diamentowych igłaków
 RUS Набор надфилей алмазных
 CZ Sada diamentových jehlových pilníků
 H Gyémánt tűreszelő készlet
- RO Set pile diamentate
 F Set de limes diamant
 I Set lime ad ago diamantate
 E Juego de limas de aguja adiamantadas
 CN 金刚石整形锉组套

POUCH



GRIT
ZIARNISTOŚĆ
150



YATO	grit / ziarnistość	coating length / długość nasypu (mm)	mm	
YT-6143	150	50	3x140	40/400
YT-6150	150	50	4x160	30/300
YT-6155	150	70	5x180	15/150

YATO	grit / ziarnistość	coating length / długość nasypu (mm)	mm	
YT-6156	150	70	5x180	10/100

- GB Diamond needle file set
 D Diamant-Nadelfeileinsatz
 PL Zestaw pilników diamentowych igłaków
 RUS Набор надфилей алмазных
 CZ Sada diamentových jehlových pilníků
 H Gyémánt tűreszelő készlet
- RO Set pile diamentate
 F Set de limes diamant
 I Set lime ad ago diamantate
 E Juego de limas de aguja adiamantadas
 CN 金刚石整形锉组套

POUCH



10
PCS
GRIT
ZIARNISTOŚĆ
150



YATO	grit / ziarnistość	coating length / długość nasypu (mm)	mm	
YT-6144	150	50	3x140	12/120

YATO	grit / ziarnistość	coating length / długość nasypu (mm)	mm	
YT-6145	150	25	3x140	12/120

- GB Diamond needle file set
D Diamant-Nadelfeilsatz
PL Zestaw pilników diamentowych iglaków
RUS Набор надфилей алмазных
CZ Sada diamentových jehlových pilníků
H Gyémánt tűreszelő készlet
- RO Set pile diamantate
F Set de limes diamant
I Set lime ad ago diamantate
E Juego de limas de aguja adiamantadas
CN 金刚石整形锉组套

POUCH

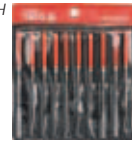

10
PCS

GRIT
ZIARNISTOŚĆ
150

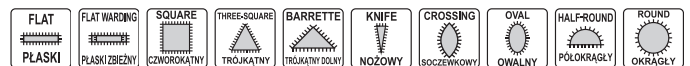

YATO	grit / ziarnistość	coating length / długość nasypu (mm)	mm	
YT-6146	150	30	3x140	12/120

YATO	grit / ziarnistość	coating length / długość nasypu (mm)	mm	
YT-6151	150	50	4x160	9/90

- GB Wood rasp
D Holzraspel
PL Tarnik do drewna
RUS Рашиля для дерева
CZ Rašple do dřeva
H Fareszelő
- RO Raspe
F Lime à bois
I Lime per legno
E Escarpelo para madera
CN 木工铍

PLASTIC
HANGER



250
mm



45

YATO	#	
YT-6219	45	12/72



45

YATO	#	
YT-6220	45	12/72



45

YATO	#	
YT-6221	45	12/72

- GB Wood rasp set
D Holzraspelsatz
PL Tarniki do drewna
RUS Рашили для дерева
- CZ Sada rašplí do dřeva
H Fareszelő
RO Set raspe
F Set de limes à bois
- I Lime per legno
E Juego de escarpelos para madera
CN 木工铍组套

SLIDING
CARD



3
PCS

45

250
mm

45

45



YATO	#	
YT-6222	45	5/20

GB Sand paper PL Papier ścierny CZ Smirkový papír RO Hârtie abrazivă I Carta vetrata CN 砂纸
 D Schleifpapier RUS Наждачная бумага H Csiszolópapír F Papier abrasif E Papel de lija

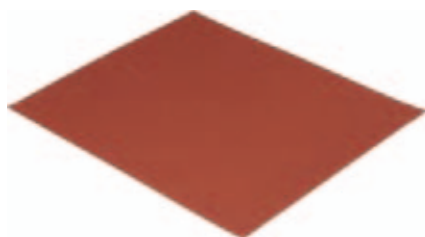

POLYBAG



- application: paint, lacquer, filler, wood
- abrasive: aluminium oxide
- bond: synthetic resin
- backing: C
- coating: semi-open
- zastosowanie: farby, lakiery, szpachle, drewno
- ścierniwo: tlenek glinu
- spoiwo: żywica syntetyczna
- podkład: C
- nasyp półotwarty



- application: paint, lacquer, filler, wood
- abrasive: aluminium oxide
- bond: synthetic resin
- backing: D
- coating: semi-open
- zastosowanie: farby, lakiery, szpachle, drewno
- ścierniwo: tlenek glinu
- spoiwo: żywica syntetyczna
- podkład: D
- nasyp półotwarty

YATO	grit / ziarnistość	size / rozmiar (mm)	PCS packing	
YT-8350	40	230x280	50	500
YT-8351	60	230x280	50	500
YT-8352	80	230x280	50	500
YT-8353	100	230x280	50	500
YT-8354	120	230x280	50	500
YT-8355	150	230x280	50	500
YT-8356	180	230x280	50	500
YT-8357	220	230x280	50	500
YT-8358	240	230x280	50	500

YATO	grit / ziarnistość	size / rozmiar	
YT-8449	40	93 mm x 5 m	12/48
YT-8450	60	93 mm x 5 m	12/48
YT-8451	80	93 mm x 5 m	12/48
YT-8452	100	93 mm x 5 m	12/48
YT-8453	120	93 mm x 5 m	12/48
YT-8454	150	93 mm x 5 m	12/48
YT-8455	180	93 mm x 5 m	12/48
YT-8456	240	93 mm x 5 m	12/48
YT-8457	320	93 mm x 5 m	12/48



POLYBAG WITH HEADER



- application: paint, lacquer, filler, wood
- abrasive: aluminium oxide
- bond: synthetic resin
- backing: D
- coating: semi-open
- zastosowanie: farby, lakiery, szpachle, drewno
- ścierniwo: tlenek glinu
- spoiwo: żywica syntetyczna
- podkład: D
- nasyp półotwarty



- application: paint, lacquer, filler, wood
- abrasive: aluminium oxide
- bond: synthetic resin
- backing: D
- coating: semi-open
- zastosowanie: farby, lakiery, szpachle, drewno
- ścierniwo: tlenek glinu
- spoiwo: żywica syntetyczna
- podkład: D
- nasyp półotwarty

YATO	grit / ziarnistość	size / rozmiar (mm)	PCS packing	
YT-8370	40	115x280	5	24/240
YT-8371	60	115x280	5	24/240
YT-8372	80	115x280	5	24/240
YT-8373	100	115x280	5	24/240
YT-8374	120	115x280	5	24/240
YT-8375	150	115x280	5	24/240
YT-8376	180	115x280	5	24/240
YT-8377	240	115x280	5	24/240
YT-8378	320	115x280	5	24/240

YATO	grit / ziarnistość	size / rozmiar	
YT-8440	40	115 mm x 5 m	12/48
YT-8441	60	115 mm x 5 m	12/48
YT-8442	80	115 mm x 5 m	12/48
YT-8443	100	115 mm x 5 m	12/48
YT-8444	120	115 mm x 5 m	12/48
YT-8445	150	115 mm x 5 m	12/48
YT-8446	180	115 mm x 5 m	12/48
YT-8447	240	115 mm x 5 m	12/48
YT-8448	320	115 mm x 5 m	12/48



POLYBAG



- application: paint, lacquer, filler, wood
- abrasive: aluminium oxide
- bond: synthetic resin
- backing: D
- coating: semi-open
- zastosowanie: farby, lakiery, szpachle, drewno
- ścierniwo: tlenek glinu
- spoiwo: żywica syntetyczna
- podkład: D
- nasyp półotwarty



- application: paint, lacquer, filler, wood
- abrasive: aluminium oxide
- bond: synthetic resin
- backing: D
- coating: semi-open
- zastosowanie: farby, lakiery, szpachle, drewno
- ścierniwo: tlenek glinu
- spoiwo: żywica syntetyczna
- podkład: D
- nasyp półotwarty

YATO	grit / ziarnistość	size / rozmiar (mm)	PCS packing	
YT-8360	40	230x280	50	500
YT-8361	60	230x280	50	500
YT-8362	80	230x280	50	500
YT-8363	100	230x280	50	500
YT-8364	120	230x280	50	500
YT-8365	150	230x280	50	500
YT-8366	180	230x280	50	500
YT-8367	240	230x280	50	500
YT-8368	320	230x280	50	500

YATO	grit / ziarnistość	size / rozmiar	
YT-8458	40	115 mm x 50 m	2
YT-8459	60	115 mm x 50 m	2
YT-8460	80	115 mm x 50 m	2
YT-8461	100	115 mm x 50 m	2
YT-8462	120	115 mm x 50 m	2
YT-8463	150	115 mm x 50 m	2
YT-8464	180	115 mm x 50 m	2
YT-8465	240	115 mm x 50 m	2
YT-8466	320	115 mm x 50 m	2

GB Sand paper PL Papier ścierny CZ Smirkový papír RO Hârtie abrazivă I Carta vetrata CN 砂纸
D Schleifpapier RUS Наждачная бумага H Csiszolópapír F Papier abrasif E Papel de lija







- application: paint, lacquer, filler, wood
- abrasive: aluminium oxide
- bond: synthetic resin
- backing: F
- coating: closed

- zastosowanie: farby, lakiery, szpachle, drewno
- ścierniwo: tlenek glinu
- spoiwo: żywica syntetyczna
- podkład: F
- nasyp pełny

- application: paint, lacquer, filler, wood
- abrasive: aluminium oxide
- bond: synthetic resin
- backing: F
- coating: closed

- zastosowanie: farby, lakiery, szpachle, drewno
- ścierniwo: tlenek glinu
- spoiwo: żywica syntetyczna
- podkład: F
- nasyp pełny

YATO 	grit / ziarnistość	size / rozmiar	
YT-8480	80	150 mm x 50 m	2
YT-8481	100	150 mm x 50 m	2
YT-8482	120	150 mm x 50 m	2

YATO 	grit / ziarnistość	size / rozmiar	
YT-8483	40	200 mm x 50 m	2
YT-8484	60	200 mm x 50 m	2
YT-8485	80	200 mm x 50 m	2
YT-8486	120	200 mm x 50 m	2

GB Sand paper PL Papier ścierny CZ Smirkový papír RO Hârtie abrazivă I Carta vetrata CN 砂纸
D Schleifpapier RUS Наждачная бумага H Csiszolópapír F Papier abrasif E Papel de lija

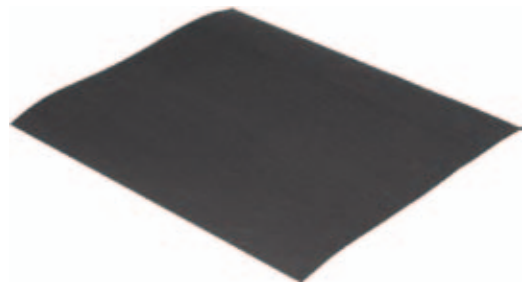
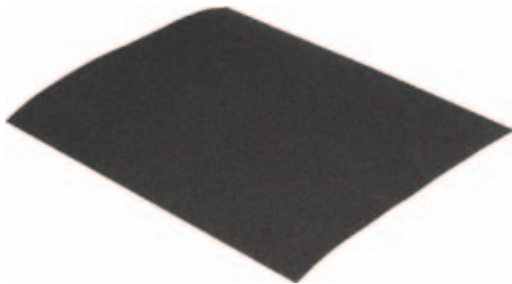

WATERPROOF
WOODPROOF

POLYBAG

WATERPROOF
WOODPROOF



POLYBAG



- application: paint, lacquer, filler
- abrasive: silicon carbide
- bond: synthetic resin
- backing: C
- coating: closed

- zastosowanie: farby, lakiery, szpachle
- ścierniwo: węgiel krzemu
- spoiwo: żywica syntetyczna
- podkład: C
- nasyp pełny

- application: paint, lacquer, filler
- abrasive: silicon carbide
- bond: synthetic resin
- backing: A
- coating: closed

- zastosowanie: farby, lakiery, szpachle
- ścierniwo: węgiel krzemu
- spoiwo: żywica syntetyczna
- podkład: A
- nasyp pełny

YATO 	grit / ziarnistość	size / rozmiar (mm)	PCS packing:	
YT-8400	60	230x280	50	500
YT-8401	80	230x280	50	500
YT-8402	100	230x280	50	500
YT-8403	120	230x280	50	500
YT-8404	150	230x280	50	500

YATO 	grit / ziarnistość	size / rozmiar (mm)	PCS packing:	
YT-8405	180	230x280	50	500
YT-8406	220	230x280	50	500
YT-8407	240	230x280	50	500
YT-8408	280	230x280	50	500
YT-8409	320	230x280	50	500
YT-8410	360	230x280	50	500
YT-8411	400	230x280	50	500
YT-8412	500	230x280	50	500
YT-8413	600	230x280	50	500
YT-8414	800	230x280	50	500
YT-8415	1000	230x280	50	500
YT-8416	1200	230x280	50	500
YT-8417	1500	230x280	50	500
YT-8418	2000	230x280	50	500

GB Abrasive cloth sheet RUS Шлифовальное полотно RO Coli panza abraziva E Hojas de pano abrasivo
D Schleifgewebe blatt CZ Brusné plátno F Tissu abrasif CN 砂布
PL Płótno ściernie arkusz H Csiszolóvászon lap I Carta vetrata

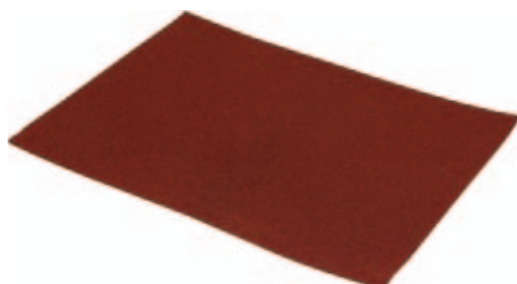



- application: metal, wood
- abrasive: aluminium oxide
- bond: semi-resin
- backing: J
- coating: close

- zastosowanie: metal, drewno
- ścierniwo: tlenek glinu
- spoiwo: żywica
- podkład: J
- nasyp pełny

POLYBAG



YATO 	grit / ziarnistość	size / rozmiar (mm)	PCS packing:	
YT-83160	36	230x280	50	250
YT-83161	40	230x280	50	250
YT-83162	60	230x280	50	250
YT-83163	80	230x280	50	250
YT-83164	100	230x280	50	250
YT-83165	120	230x280	50	500
YT-83166	150	230x280	50	500
YT-83167	180	230x280	50	500
YT-83168	220	230x280	50	500
YT-83169	240	230x280	50	500

GB Abrasive cloth roll **RUS** Рулон-шлифовальное полотно **RO** Rola panza abraziva **E** Rollo de pano abrasivo
D Schleifgewebe rolle **CZ** Brusné plátno role **F** Tissu abrasif rouleau **CN** 砂布
PL Płótno ścierna rolka **H** Csiszolóvászon tekercs **I** Carta vetrata rotolo



- application: metal, wood
- abrasive: aluminium oxide
- bond: semi-resin
- backing: J
- coating: close
- zastosowanie: metal, drewno
- ścierniwo: tlenek glinu
- spoiwo: żywica
- podkład: J
- nasyp pełny
- application: metal, wood
- abrasive: aluminium oxide
- bond: semi-resin
- backing: J
- coating: close
- zastosowanie: metal, drewno
- ścierniwo: tlenek glinu
- spoiwo: żywica
- podkład: J
- nasyp pełny
- application: metal, wood
- abrasive: aluminium oxide
- bond: semi-resin
- backing: J
- coating: close
- zastosowanie: metal, drewno
- ścierniwo: tlenek glinu
- spoiwo: żywica
- podkład: J
- nasyp pełny

YATO	grit / ziarnistość	size / rozmiar	PCS
YT-83180	36	150 mm x 30 m	2
YT-83181	40	150 mm x 30 m	2

YATO	grit / ziarnistość	size / rozmiar	PCS
YT-83182	50	150 mm x 50 m	2
YT-83183	60	150 mm x 50 m	2
YT-83184	80	150 mm x 50 m	2
YT-83185	100	150 mm x 50 m	2
YT-83186	120	150 mm x 50 m	2
YT-83187	150	150 mm x 50 m	2
YT-83188	180	150 mm x 50 m	2
YT-83189	220	150 mm x 50 m	2
YT-83190	240	150 mm x 50 m	2

YATO	grit / ziarnistość	size / rozmiar	PCS
YT-83200	24	200mm x 30 m	2
YT-83201	36	200mm x 30 m	2
YT-83202	40	200mm x 30 m	2
YT-83203	50	200mm x 50 m	2
YT-83204	60	200mm x 50 m	2
YT-83205	80	200mm x 50 m	2
YT-83206	100	200mm x 50 m	2
YT-83207	120	200mm x 50 m	2
YT-83208	150	200mm x 50 m	2
YT-83209	180	200mm x 50 m	2
YT-83210	220	200mm x 50 m	2
YT-83211	240	200mm x 50 m	2

10

GB Endless sanding belt **RUS** Шлифовальные ленты **RO** Bandă de pânză **E** Pano abrasivo cinturón
D Schleifband **CZ** Brusný pás **F** Bande abrasive sans fin **CN** 砂带
PL Taśma ścierna bezkońcowa **H** Csiszoló szalag **I** Nastro abrasivo senza fine

HANGING COLOR BOX



- application: metal, wood
- abrasive: aluminium oxide
- bond: synthetic resin
- coating: close
- zastosowanie: metal, drewno
- ścierniwo: tlenek glinu
- spoiwo: żywica syntetyczna
- nasyp pełny
- application: metal, wood
- abrasive: aluminium oxide
- bond: synthetic resin
- coating: close
- zastosowanie: metal, drewno
- ścierniwo: tlenek glinu
- spoiwo: żywica syntetyczna
- nasyp pełny

YATO	grit / ziarnistość	size / rozmiar (mm)	PCS packing
YT-09743	60	10x330	10 100
YT-09744	80	10x330	10 100
YT-09745	100	10x330	10 100
YT-09746	120	10x330	10 100

YATO	grit / ziarnistość	size / rozmiar (mm)	PCS packing
YT-09747	60	20x520	10 50
YT-09748	80	20x520	10 50
YT-09749	100	20x520	10 50
YT-09750	120	20x520	10 50

GB No end abrasive band **RUS** Шлифлента бесконечная **RO** Curea abraziva **E** Banda abrasiva sin fin
D Schleifband **CZ** Brusný pás **F** Bande abrasive sans fin **CN** 砂带
PL Pas ścierny bezkońcowa **H** Csiszoló szalag **I** Nastro abrasivo senza fine



- application: metal, wood
- abrasive: aluminium oxide
- bond: synthetic resin
- coating: close
- zastosowanie: metal, drewno
- ścierniwo: tlenek glinu
- spoiwo: żywica syntetyczna
- nasyp pełny
- application: metal, wood
- abrasive: aluminium oxide
- bond: synthetic resin
- coating: close
- zastosowanie: metal, drewno
- ścierniwo: tlenek glinu
- spoiwo: żywica syntetyczna
- nasyp pełny
- application: metal, wood
- abrasive: aluminium oxide
- bond: synthetic resin
- coating: close
- zastosowanie: metal, drewno
- ścierniwo: tlenek glinu
- spoiwo: żywica syntetyczna
- nasyp pełny

YATO	grit / ziarnistość	size / rozmiar (mm)	PCS packing
YT-83220	36	75x457	5 20/60
YT-83221	40	75x457	5 20/60
YT-83222	60	75x457	5 20/60
YT-83223	80	75x457	5 20/60
YT-83224	100	75x457	5 20/60
YT-83225	120	75x457	5 20/60
YT-83226	150	75x457	5 20/60

YATO	grit / ziarnistość	size / rozmiar (mm)	PCS packing
YT-83227	36	75x533	5 20/60
YT-83228	40	75x533	5 20/60
YT-83229	60	75x533	5 20/60
YT-83230	80	75x533	5 20/60
YT-83231	100	75x533	5 20/60
YT-83232	120	75x533	5 20/60
YT-83233	150	75x533	5 20/60

YATO	grit / ziarnistość	size / rozmiar (mm)	PCS packing
YT-83234	36	100x610	5 10/30
YT-83235	40	100x610	5 10/30
YT-83236	60	100x610	5 10/30
YT-83237	80	100x610	5 20/60
YT-83238	100	100x610	5 20/60
YT-83239	120	100x610	5 20/60
YT-83240	150	100x610	5 20/60

GB Flap disc – regular shape
D Fächerschleifscheibe - Gerade
PL Ściernica listkowa talerzowa płaska
RUS Круг лепестковый тарельчатый
CZ Lamelový brusný kotouč
H Lamellás csiszoló normál

RO Disc lamelar frontal
F Disque à lamelles abrasives plat
I Disco abrasivo per metallo
E Discos de paño abrasivo
CN 百叶轮

- application: metal
- abrasive: aluminium oxide
- bond: synthetic resin
- backing: fibreglass
- zastosowanie: metal
- ścierniwo: tlenek glinu
- spoiwo: żywica syntetyczna
- podkład: włókno szklane



YATO	grit / ziarnistość	size / rozmiar (mm)	
YT-83271	36	125x22.4	25/100
YT-83272	40	125x22.4	25/100
YT-83273	60	125x22.4	50/200
YT-83274	80	125x22.4	50/200
YT-83275	100	125x22.4	50/200
YT-83276	120	125x22.4	50/200

GB Flap disc – depressed shape
D Fächerschleifscheibe - Gewölbt
PL Ściernica listkowa talerzowa wypukła
RUS Круг лепестковый тарельчатый
CZ Lamelový brusný kotouč - vypouklý
H Lamellás csiszoló döntött

RO Disc lamelar frontal depresat
F Disque à lamelles abrasives bombé
I Disco abrasivo a centro depresso
E Discos de paño abrasivo centro embutido
CN 百叶轮

- application: metal
- abrasive: aluminium oxide
- bond: synthetic resin
- backing: fibreglass
- zastosowanie: metal
- ścierniwo: tlenek glinu
- spoiwo: żywica syntetyczna
- podkład: włókno szklane



YATO	grit / ziarnistość	size / rozmiar (mm)	
YT-83291	36	125x22.4	25/100
YT-83292	40	125x22.4	25/100
YT-83293	60	125x22.4	50/200
YT-83294	80	125x22.4	50/200
YT-83295	100	125x22.4	50/200
YT-83296	120	125x22.4	50/200

GB Flap wheel with shaft
D Fächerschleifmop mit Schaft
PL Ściernica listkowa trzpieniowa
RUS Круг лепестковый со шпинделем
CZ Lamelový kotouč s hřídelý
H Legyező csiszoló csapos

RO Perie abraziva circulara cu tija
F Disque à lamelles abrasives pivot
I Ruote lamellari
E Rueda laminar en tela abrasiva
CN 百叶轮

- application: metal
- abrasive: aluminium oxide
- bond: synthetic resin
- zastosowanie: metal
- ścierniwo: tlenek glinu
- spoiwo: żywica syntetyczna



YATO	grit / ziarnistość	size / rozmiar (mm)	
YT-83351	40	40x20x6	10/60
YT-83352	60	40x20x6	10/60
YT-83353	80	40x20x6	10/60
YT-83354	100	40x20x6	10/60
YT-83355	120	40x20x6	10/60
YT-83356	150	40x20x6	10/60

- application: metal
- abrasive: aluminium oxide
- bond: synthetic resin
- zastosowanie: metal
- ścierniwo: tlenek glinu
- spoiwo: żywica syntetyczna



YATO	grit / ziarnistość	size / rozmiar (mm)	
YT-83361	40	60x30x6	10/60
YT-83362	60	60x30x6	10/60
YT-83363	80	60x30x6	10/60
YT-83364	100	60x30x6	10/60
YT-83365	120	60x30x6	10/60
YT-83366	150	60x30x6	10/60

- application: metal
- abrasive: aluminium oxide
- bond: synthetic resin
- zastosowanie: metal
- ścierniwo: tlenek glinu
- spoiwo: żywica syntetyczna



- application: metal
- abrasive: aluminium oxide
- bond: synthetic resin
- zastosowanie: metal
- ścierniwo: tlenek glinu
- spoiwo: żywica syntetyczna



YATO	grit / ziarnistość	size / rozmiar (mm)	
YT-83371	40	80x30x6	10/60
YT-83372	60	80x30x6	10/60
YT-83373	80	80x30x6	10/60
YT-83374	100	80x30x6	10/60
YT-83375	120	80x30x6	10/60
YT-83376	150	80x30x6	10/60

YATO	grit / ziarnistość	size / rozmiar (mm)	
YT-83381	40	80x40x6	10/60
YT-83382	60	80x40x6	10/60
YT-83383	80	80x40x6	10/60
YT-83384	100	80x40x6	10/60
YT-83385	120	80x40x6	10/60
YT-83386	150	80x40x6	10/60

GB Flap wheel with shaft
D Fächerschleifmop mit Schaft
PL Ściernica listkowa trzpieniowa
RUS Круг лепестковый со шпинделем
CZ Lamelový kotouč s hřídelý
H Legyező csiszoló csapos

RO Perie abraziva circulara cu tija
F Disque à lamelles abrasives pivot
I Ruote lamellari
E Rueda laminar en tela abrasiva
CN 百叶轮

- application: metal
- abrasive: aluminium oxide
- bond: synthetic resin
- zastosowanie: metal
- ścierniwo: tlenek glinu
- spoiwo: żywica syntetyczna



YATO	grit / ziarnistość	size / rozmiar (mm)	
YT-83390	60	50x30x6	10/60
YT-83391	100	50x30x6	10/60
YT-83392	150	50x30x6	10/60
YT-83393	200	50x30x6	10/60

- application: metal
- abrasive: aluminium oxide
- bond: synthetic resin
- zastosowanie: metal
- ścierniwo: tlenek glinu
- spoiwo: żywica syntetyczna

YATO	grit / ziarnistość	size / rozmiar (mm)	
YT-83394	60	60x50x6	10/60
YT-83395	100	60x50x6	10/60
YT-83396	150	60x50x6	10/60
YT-83397	200	60x50x6	10/60

- application: metal
- abrasive: aluminium oxide
- bond: synthetic resin
- zastosowanie: metal
- ścierniwo: tlenek glinu
- spoiwo: żywica syntetyczna

YATO	grit / ziarnistość	size / rozmiar (mm)	
YT-83398	60	80x50x6	10/60
YT-83399	100	80x50x6	10/60
YT-83400	150	80x50x6	10/60
YT-83401	200	80x50x6	10/60

GB Abrasive disc
D Schleifpapier zum Gummiteiler
PL Krawężek ścierny
RUS Круг шлифовальный
CZ Brusný kotouč
H Csiszolótárcsa
RO Disc abraziv
F Disques abrasifs avec velcro
I Disco abrasivo
E Juego de discos abrasivos
CN 圆形砂纸

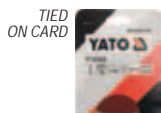

5
PCS
HOOK
FASTENER
RZEP

- application: metal, wood
- abrasive: aluminium oxide
- bond: synthetic resin
- backing: C
- coating: semi-open
- zastosowanie: metal, drewno
- ścierniwo: tlenek glinu
- spoiwo: żywica syntetyczna
- podkład: C
- nasyp półotwarty

YATO	grit / ziarnistość	Ø (mm)	□
YT-83420	36	115	50/200
YT-83421	40	115	50/200
YT-83422	60	115	50/200
YT-83423	80	115	50/200
YT-83424	100	115	50/200
YT-83425	120	115	50/200
YT-83426	150	115	50/200
YT-83427	180	115	50/200
YT-83428	220	115	50/200



GB Abrasive disc
D Schleifpapier zum Gummiteiler
PL Krawężek ścierny
RUS Круг шлифовальный
CZ Brusný kotouč
H Csiszolótárcsa
RO Disc abraziv
F Disques abrasifs avec velcro
I Disco abrasivo
E Juego de discos abrasivos
CN 圆形砂纸



5
PCS
HOOK
FASTENER
RZEP

- application: metal, wood
- abrasive: aluminium oxide
- bond: synthetic resin
- backing: C
- coating: semi-open
- zastosowanie: metal, drewno
- ścierniwo: tlenek glinu
- spoiwo: żywica syntetyczna
- podkład: C
- nasyp półotwarty

YATO	grit / ziarnistość	Ø (mm)	□
YT-83430	36	125	50/200
YT-83431	40	125	50/200
YT-83432	60	125	50/200
YT-83433	80	125	50/200
YT-83434	100	125	50/200
YT-83435	120	125	50/200
YT-83436	150	125	50/200
YT-83437	180	125	50/200
YT-83438	220	125	50/200



GB Abrasive disc with holes
D Schleifpapier zum Gummiteiler mit lochen
PL Krawężek ścierny z otworami
RUS Круг шлифовальный перфорированный с липучкой
CZ Brusný kotouč z otvorami
H Fibertárcsa lyukkakkal tépózárás
RO Disc abraziv cu orificii
F Disques abrasifs trous avec velcro
I Disco abrasivo con fori
E Juego de discos abrasivos con agujeros
CN 圆形带孔砂纸



5
PCS
HOOK
FASTENER
RZEP

- application: metal, wood
- abrasive: aluminium oxide
- bond: synthetic resin
- backing: C
- coating: semi-open
- zastosowanie: metal, drewno
- ścierniwo: tlenek glinu
- spoiwo: żywica syntetyczna
- podkład: C
- nasyp półotwarty

YATO	grit / ziarnistość	Ø (mm)	□
YT-83440	36	115	50/200
YT-83441	40	115	50/200
YT-83442	60	115	50/200
YT-83443	80	115	50/200
YT-83444	100	115	50/200
YT-83445	120	115	50/200
YT-83446	150	115	50/200
YT-83447	180	115	50/200
YT-83448	220	115	50/200



GB Abrasive disc with holes
D Schleifpapier zum Gummiteiler mit lochen
PL Krawężek ścierny z otworami
RUS Круг шлифовальный перфорированный с липучкой
CZ Brusný kotouč z otvorami
H Fibertárcsa lyukkakkal tépózárás
RO Disc abraziv cu orificii
F Disques abrasifs trous avec velcro
I Disco abrasivo con fori
E Juego de discos abrasivos con agujeros
CN 圆形带孔砂纸



5
PCS
HOOK
FASTENER
RZEP

- application: metal, wood
- abrasive: aluminium oxide
- bond: synthetic resin
- backing: C
- coating: semi-open
- zastosowanie: metal, drewno
- ścierniwo: tlenek glinu
- spoiwo: żywica syntetyczna
- podkład: C
- nasyp półotwarty

YATO	grit / ziarnistość	Ø (mm)	□
YT-83451	40	125	50/200
YT-83452	60	125	50/200
YT-83453	80	125	50/200
YT-83454	100	125	50/200
YT-83455	120	125	50/200
YT-83456	150	125	50/200
YT-83457	180	125	50/200
YT-83458	220	125	50/200



GB Abrasive sheet with holes
D Schleifgewebe-scheiben mit lochen
PL Arkusz ścierny z otworami
RUS Шлифовальная перфорированная бумага для виброшлифмашинки
CZ Brusné archy z otvorami
H Csiszoló lap lyukkakkal
RO Coale (foi) abrazive cu orificii
F Disques abrasifs trous avec velcro
I Disco abrasivo con fori
E Ojas abrasivas con agujeros
CN 方形带孔砂纸



5
PCS
HOOK
FASTENER
RZEP

- application: paint, lacquer, filler
- abrasive: aluminium oxide
- bond: synthetic resin
- backing: C
- coating: semi-open
- zastosowanie: farby, lakiery, szpachle
- ścierniwo: tlenek glinu
- spoiwo: żywica syntetyczna
- podkład: C
- nasyp półotwarty

YATO	grit / ziarnistość	size / rozmiar (mm)	□
YT-83480	40	93x180	25/100
YT-83481	60	93x180	25/100
YT-83482	80	93x180	25/100
YT-83483	100	93x180	25/100
YT-83484	120	93x180	25/100
YT-83485	150	93x180	50/200
YT-83486	180	93x180	50/200
YT-83487	220	93x180	50/200
YT-83488	240	93x180	50/200



GB Abrasive sheet with holes
D Schleifgewebe-scheiben mit lochen
PL Arkusz ścierny z otworami
RUS Шлифовальная перфорированная бумага для виброшлифмашинки
CZ Brusné archy z otvorami
H Csiszoló lap lyukkakkal
RO Coale (foi) abrazive cu orificii
F Disques abrasifs trous avec velcro
I Disco abrasivo con fori
E Ojas abrasivas con agujeros
CN 方形带孔砂纸



5
PCS
HOOK
FASTENER
RZEP

- application: metal, wood
- abrasive: aluminium oxide
- bond: synthetic resin
- backing: C
- coating: semi-open
- zastosowanie: metal, drewno
- ścierniwo: tlenek glinu
- spoiwo: żywica syntetyczna
- podkład: C
- nasyp półotwarty

YATO	grit / ziarnistość	size / rozmiar (mm)	□
YT-83490	40	93x230	25/100
YT-83491	60	93x230	25/100
YT-83492	80	93x230	25/100
YT-83493	100	93x230	25/100
YT-83494	120	93x230	25/100
YT-83495	150	93x230	25/100
YT-83496	180	93x230	25/100
YT-83497	220	93x230	25/100
YT-83498	240	93x230	25/100







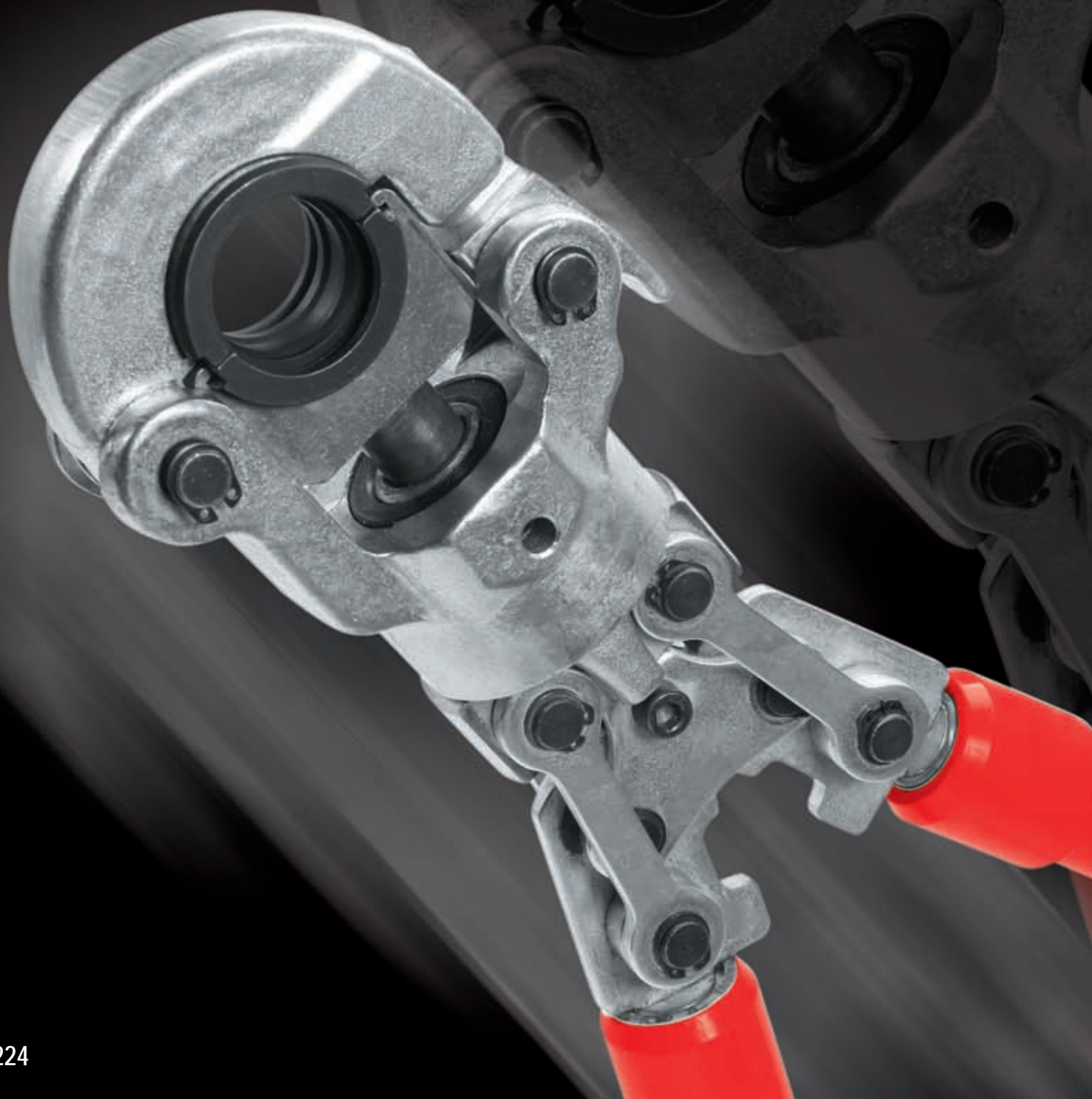

Memo

11

Hydraulic tools Narzędzia hydrauliczne



<p>Ratchet die stock sets Gwintownice ręczne z zestawem głowic</p> <p>226</p>		<p>Calibrators Kalibratory</p> <p>232</p>	
<p>Accessories for ratchet die stock Akcesoria do gwintownic ręcznych</p> <p>226</p>		<p>Burners & soldering tools Palniki i lutownice</p> <p>233</p>	
<p>Pipe wrenches Klucze do rur</p> <p>227</p>		<p>Pipe welders Zgrzewarki do rur</p> <p>234</p>	
<p>Chain pipe wrenches Klucze do rur łańcuchowe</p> <p>228</p>		<p>Pipe crimping pliers & accessories Zaciskarki do rur i akcesoria</p> <p>234</p>	
<p>Water pump pliers Szczypce nastawne</p> <p>228</p>		<p>Hinged pipe vices Imadła zaciskowe do rur</p> <p>234</p>	
<p>Step wrenches Klucze sztorcowe</p> <p>228</p>		<p>Deburrers & accessories Gratowniki i akcesoria</p> <p>235</p>	
<p>Pipe cutters Obcinaki do rur</p> <p>229-230</p>		<p>Pipe brushes Szczotki do rur</p> <p>235</p>	
<p>Pipe benders Giętarki do rur</p> <p>231</p>		<p>Cleaning pads for pipes Włókniny do czyszczenia rur</p> <p>235</p>	
<p>Hand flaring tools sets Praski do rozszerzania rur</p> <p>232</p>		<p>Tool boxes & tools in PVC trays Skrzynki narzędziowe i zestawy narzędzi do szuflad</p> <p>236-237</p>	

- GB Ratchet die stocks
- D Rohrgewinde-schneidsatz
- PL Gwintownica z zestawem głowic
- RUS Набор плашек
- CZ Sada závitníků
- H Menetfűró készlet
- RO Trusa filiere
- F Taraud manuel
- I Filiere per tubi a mano
- E Juego de roscar
- CN 管子铰板组套



9Cr2

BMC & COLOR SLEEVE

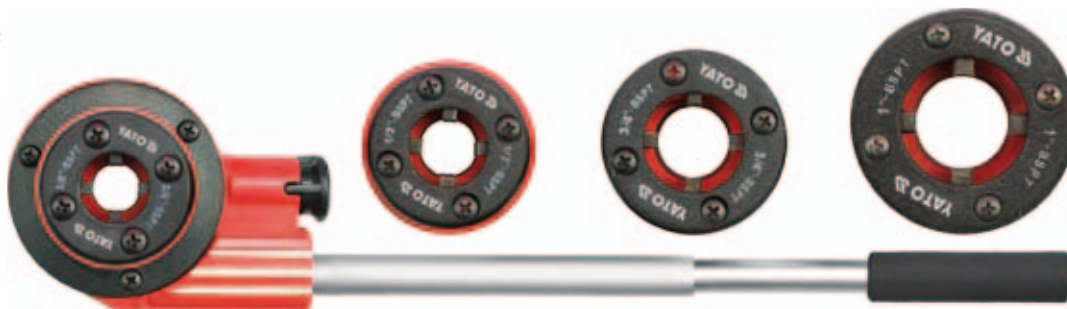

5 PCS	3/8"	1/2"	3/4"	1"
	10mm	12.5mm	19mm	25mm

YATO	size / rozmiar	
YT-29001	3/8" (10.0 mm); 1/2" (12.5 mm); 3/4" (19.0 mm); 1" (25.0 mm)	4

11



7 PCS	1/4"	3/8"	1/2"	3/4"	1"	5/4"
	6.3mm	10mm	12.5mm	19mm	25mm	32mm

YATO	size / rozmiar	
YT-2900	1/4" (6.3 mm); 3/8" (10.0 mm); 1/2" (12.5 mm); 3/4" (19.0 mm); 1" (25.0 mm); 5/4" (32.0 mm)	4

- GB Spare knives for ratchet die stock
- D Rohrgewinde-Schneidbacken
- PL Noże zapasowe do gwintownicy ręcznej
- RUS Запасные ножи для оправки
- CZ Náhradní nože do ručního závitového
- H Tartalék kések, racsnis csőmenetvágóhoz

- RO Cutit de rezerva pt. filiera
- F Lame pour taraud à main
- I Lame di ricambio per filettatrici manuale
- E Filos de recambio para terraja de mano
- CN 板牙

4
PCS

9Cr2



POLYBAG WITH HEADER



YATO	size / rozmiar	PCS packing	
YT-2910	1/4" (6.3 mm)	4	50/200
YT-2911	3/8" (10.0 mm)	4	50/200
YT-2912	1/2" (12.5 mm)	4	50/200
YT-2913	3/4" (19.0 mm)	4	50/200
YT-2914	1" (25.0 mm)	4	50/200

- GB Spare head for ratchet die stock
- D Rohrgewinde-Schneidköpfe
- PL Głowica zapasowa do gwintownicy ręcznej
- RUS Запасная оправка для нарезания трубной резьбы
- CZ Náhradní hlava pro ruční závitověz
- H Tartalék fej, racsnis csőmenetvágóhoz
- RO Cap de rezerva pt. placa filetat cu clichet
- F Mandrin porte-taraud

- I Testina ricambio per filettatrici manuale
- E Cabeza de recambio para terraja de mano
- CN 板牙头

9Cr2



COLOR BOX



YATO	size / rozmiar	
YT-2916	1/4" (6.3 mm)	10/40
YT-2917	3/8" (10.0 mm)	10/40
YT-2918	1/2" (12.5 mm)	10/40
YT-2919	3/4" (19.0 mm)	10/40
YT-2920	1" (25.0 mm)	10/40
YT-2921	5/4" (32.0 mm)	10/40

GB Pipe wrench
D Rohrschlüssel
PL Klucz do rur
RUS Ключ трубный
CZ Klíč součástí na trubky
H Csőkulcs
RO Cheie reglabila pt. tevi
F Clé aux tubes
I Chiave per tubi
E Llave para tubos
CN 铝合金管钳



CrMo HRC 55-60 AI HANDLE

YATO	size / rozmiar	max. pipe diameter / max. średnica rury	
YT-2482	14" (350 mm)	2" (50 mm)	6/12
YT-2483	18" (450 mm)	2.5" (63 mm)	2/10
YT-2484	24" (600 mm)	3" (75 mm)	2/6
YT-2485	36" (900 mm)	5" (125 mm)	3

GB Pipe wrench
D Rohrschlüssel
PL Klucz do rur
RUS Ключ трубный
CZ Klíč součástí na trubky
H Csőkulcs
RO Cheie reglabila pt. tevi
F Clé aux tubes
I Chiave per tubi
E Llave para tubos
CN 铝合金管钳



HRC 55-60 AI HANDLE

YATO	size / rozmiar	max. pipe diameter / max. średnica rury	
YT-2222	12" (300 mm)	1" (25 mm)	6/24
YT-2223	14" (350 mm)	1.5" (38 mm)	4/16
YT-2224	18" (450 mm)	2" (50 mm)	3/12
YT-2225	24" (600 mm)	2.5" (63 mm)	3/6

GB Pipe wrench
D Rohrschlüssel
PL Klucz do rur
RUS Ключ трубный
CZ Klíč součástí na trubky
H Csőkulcs
RO Cheie reglabila pt. tevi
F Clé aux tubes
I Chiave per tubi
E Llave para tubos
CN 铝合金管钳



HRC 55-60 OFFSET TYPE

YATO	size / rozmiar	max. pipe diameter / max. średnica rury	
YT-2201	10" (250 mm)	1" (25 mm)	6/36
YT-2203	14" (350 mm)	1.5" (38 mm)	4/16
YT-2204	18" (450 mm)	2" (50 mm)	3/12
YT-2205	24" (600 mm)	2.5" (63 mm)	3/6
YT-2206	36" (900 mm)	4" (100 mm)	2/4

GB Pipe wrench
D Rohrschlüssel
PL Klucz do rur
RUS Ключ трубный
CZ Klíč součástí na trubky
H Csőkulcs
RO Cheie reglabila pt. tevi
F Clé aux tubes
I Chiave per tubi
E Llave para tubos
CN 铝合金管钳



CrMo HRC 55-60

YATO	size / rozmiar	max. pipe diameter / max. średnica rury	
YT-2488	10" (250 mm)	1" (25 mm)	6/18
YT-2489	12" (300 mm)	1.5" (38 mm)	6/12
YT-2490	14" (350 mm)	2" (50 mm)	2/10
YT-2491	18" (450 mm)	2.5" (63 mm)	3/6
YT-2492	24" (600 mm)	3" (75 mm)	2/4
YT-2493	36" (900 mm)	5" (125 mm)	1
YT-2494	48" (1200 mm)	6" (150 mm)	1

GB Adjustable pipe wrench
D Rohrschlüssel
PL Klucz nastawny do rur
RUS Ключ трубный переставной

CZ Nastavitelný klíč na trubky
H Állítható csőkulcs
RO Cheie reglabilă pt. țevi
F Clé serre-tube „suédois”

I Pinze regolabili per tubi
E Llave para tubos tipo Inglesa
CN 鹰嘴钳

COLOR BOX



90° 1" 25mm 1.5" 38mm 2" 50mm
DIN 5234 CrV 6140



YATO	max. pipe diameter / max. średnica rury	L (mm)	
YT-2210	1" (25 mm)	320	24
YT-2211	1.5" (38 mm)	420	18
YT-2212	2" (50 mm)	560	12

GB Adjustable pipe wrench
D Rohrschlüssel
PL Klucz nastawny do rur
RUS Ключ трубный переставной

CZ Nastavitelný klíč na trubky
H Állítható csőkulcs
RO Cheie reglabilă pt. țevi
F Clé serre-tube „suédois”

I Pinze regolabili per tubi
E Llave para tubos tipo Inglesa
CN 鹰嘴钳

COLOR BOX



45° 1" 25mm 1.5" 38mm 2" 50mm
DIN 5234 CrV 6140



YATO	max. pipe diameter / max. średnica rury	L (mm)	
YT-2213	1" (25 mm)	330	24
YT-2214	1.5" (38 mm)	415	18
YT-2215	2" (50 mm)	530	12

GB Adjustable pipe wrench
D Rohrschlüssel
PL Klucz nastawny do rur
RUS Ключ трубный переставной

CZ Nastavitelný klíč na trubky
H Állítható csőkulcs
RO Cheie reglabilă pt. țevi
F Clé serre-tube „suédois”

I Pinze regolabili per tubi
E Llave para tubos tipo Inglesa
CN 鹰嘴钳

COLOR BOX



S 1" 25mm 1.5" 38mm 2" 50mm
DIN 5234 CrV 6140



YATO	max. pipe diameter / max. średnica rury	L (mm)	
YT-2216	1" (25 mm)	330	24
YT-2217	1.5" (38 mm)	420	18
YT-2218	2" (50 mm)	535	12

- GB Chain pipe wrench
- D Kettenrohrzange
- PL Klucz łańcuchowy do rur
- RUS Ключ цепной для труб
- CZ Klíč řetězový na trubky
- H Láncos csőfogó
- RO Cheie reglabila pt. tevi cu lant
- F Clé à chaîne
- I Chiave a catena per tubi
- E Llave de cadena
- CN 链条管子钳

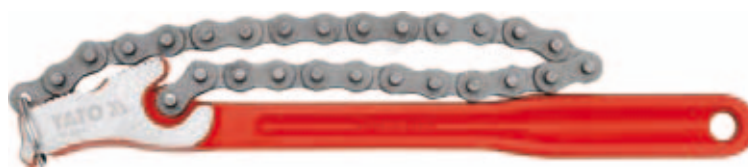

SLIDING CARD



4" 300 mm
Ø 100 mm
INDUCTION HARDENED TEETH
ZĘBY HARTOWANE INDUSTRYALNE
ADJUSTABLE WORKING RANGE
REGULOWANY ZAKRES PRACY

YATO	L (mm)	max. pipe diameter / max. średnica rury	
YT-22260	300	4" (100 mm)	6/24

- GB Water pump pliers
- D Wasserpumpenzange
- PL Szczypce nastawne
- RUS Клещи переставные
- CZ Keleště siko
- H Vizpumpafagó
- RO Cleste papagal
- F Pince réglable
- I Pinze regolabili
- E Alicates de fontanero ajustables
- CN 水泵钳

250 mm 300 mm CrV



YATO	L (mm)	
YT-2090	250	6/36
YT-2091	300	6/36

- GB Water pump pliers
- D Wasserpumpenzange
- PL Szczypce nastawne
- RUS Клещи переставные
- CZ Keleště siko
- H Vizpumpafagó
- RO Cleste papagal
- F Pince réglable
- I Pinze regolabili
- E Alicates de fontanero ajustables
- CN 水泵钳

250 mm 6 mm CrV

JAW WIDTH SZEROKOŚĆ PŁY SZCZĘK 6 mm
WORKING RANGE ADJUSTMENT REGULACJA ZAKRESU PRACY
STRENGTHENED JAWS WZMOCNIENIA KONSTRUKCJA



YATO	L (mm)	
YT-20911	250	10/50

- GB Water pump pliers
- D Wasserpumpenzange
- PL Szczypce nastawne
- RUS Клещи переставные
- CZ Keleště siko
- H Vizpumpafagó
- RO Cleste papagal
- F Pince réglable
- I Pinze regolabili
- E Alicates de fontanero ajustables
- CN 水泵钳

HALF DOUBLE BLISTER



250 mm NICKEL IRON FINISH



YATO	L (mm)	
YT-2069	250	6/36



YATO	L (mm)	
YT-2070	250	6/24

- GB Water pump pliers
- D Wasserpumpenzange
- PL Szczypce nastawne
- RUS Клещи переставные
- CZ Keleště siko
- H Vizpumpafagó
- RO Cleste papagal
- F Pince réglable
- I Pinze regolabili
- E Alicates de fontanero ajustables
- CN 水泵钳



250 mm CrV 1000 V DVE

1000V VDE CERTIFICATE EN 60900:2012

HALF DOUBLE BLISTER



YATO	L (mm)	
YT-21161	250	6/24

- GB Internal ratchet wrench
- D Innenratschenschlüssel
- PL Grzechotka wewnętrzna
- RUS Трещотка внутренняя
- CZ Radiátorový kluč s ráčnou
- H Lépcsős kulcskészlet racsniával
- RO Cheie robinet radiator
- F Clé de montage étagee
- I Cricchetto di tipo interno
- E Llave carraca radiadores
- CN 穿心棘轮扳手

1/2" 12.5 mm CrV 30T



for / dla: YT-03316

TIED ON CARD

YATO		
YT-03315	1/2" (12.7 mm)	6/24

- GB Step wrench
- D Stufenschlüssel
- PL Klucz stopniowy
- RUS Калибратор FORA для металлопластиковых труб
- CZ Klíč na radiátorové šroubení
- H Lépcsős radiátor kulcs
- RO Cheie in trepte pt. radiator
- F Clé de montage étagee
- I Chiave a cricco
- E Llave de radiadores
- CN 散熱六角階梯扳手

1/2" 12.5 mm 3/8" 29/68" 1/2" 21/32" 27/32" 9.6 mm 11.6 mm 12.6 mm 16.4 mm 21 mm



for / dla: YT-03315

POLYBAG WITH HEADER

YATO		
YT-03316	1/2" (12.7 mm)	100

- GB PVC pipe cutter
D PVC Rohrabsschneider
PL Obcinak do rur PCV
RUS Труборез для ПВХ труб
CZ Řezač PVC trubek
H Csővágó olló PVC csövekhez
RO Clește pt. tăiat țevi din PVC
F Coupeur aux tubes
I Taglia tubi PVC
E Cortatubos PVC
CN PVC 管子割刀



∅ max (mm) 35	PEX AL PEX	PVC PP PU PE	PEX AL PEX	8Cr13 STAINLESS STEEL STAL NIERZĘDZWA	HRC 54
-------------------------	------------------	-----------------------	------------------	---	-----------

SLIDING
CARD



YATO	max. ∅ (mm)	
YT-2230	35	6/48

- GB PVC pipe cutter
D PVC Rohrabsschneider
PL Obcinak do rur PCV
RUS Труборез для ПВХ труб
CZ Řezač PVC trubek
H Csővágó olló PVC csövekhez
RO Clește pt. tăiat țevi din PVC
F Coupeur aux tubes
I Taglia tubi PVC
E Cortatubos PVC
CN PVC 管子割刀



∅ max (mm) 42	PEX AL PEX	PVC PP PU PE	8Cr13 STAINLESS STEEL STAL NIERZĘDZWA	HRC 54	RATCHET SYSTEM ZAPADKOWY	QUICK RELEASE SZYBKIE ZWALNIANIE
-------------------------	------------------	-----------------------	---	-----------	--------------------------------	---

SLIDING
CARD



YATO	max. ∅ (mm)	
YT-2231	42	6/48

- GB PVC pipe cutter
D PVC Rohrabsschneider
PL Obcinak do rur PCV
RUS Труборез для ПВХ труб
CZ Řezač PVC trubek
H Csővágó olló PVC csövekhez
RO Clește pt. tăiat țevi din PVC
F Coupeur aux tubes
I Taglia tubi PVC
E Cortatubos PVC
CN PVC 管子割刀



∅ max (mm) 63	PEX AL PEX	PVC PP PU PE	8Cr13 STAINLESS STEEL STAL NIERZĘDZWA	HRC 56-58	RATCHET SYSTEM ZAPADKOWY	QUICK RELEASE SZYBKIE ZWALNIANIE
-------------------------	------------------	-----------------------	---	--------------	--------------------------------	---

SLIDING
CARD



YATO	max. ∅ (mm)	
YT-22312	63	6/24

- GB PVC pipe cutter
D PVC Rohrabsschneider
PL Obcinak do rur PCV
RUS Труборез для ПВХ труб
CZ Řezač PVC trubek
H Csővágó olló PVC csövekhez
RO Clește pt. tăiat țevi din PVC
F Coupeur aux tubes
I Taglia tubi PVC
E Cortatubos PVC
CN PVC 管子割刀



SLIDING
CARD



PEX AL PEX	PVC PP PU PE	8Cr13 STAINLESS STEEL STAL NIERZĘDZWA	HRC 54	AI	RATCHET SYSTEM ZAPADKOWY	QUICK RELEASE SZYBKIE ZWALNIANIE
------------------	-----------------------	---	-----------	----	--------------------------------	---

∅ max (mm) 51

YATO	max. ∅ (mm)	
YT-2228	51	6/24



∅ max (mm) 64

YATO	max. ∅ (mm)	
YT-2229	64	6/24

- GB Pipe cutter
D Rohrabsschneider
PL Obcinak do rur
RUS Труборез для труб
CZ Řezač trubek
H Csővágó olló csövekhez
RO Clește pt. tăiat țevi
F Coupeurs aux tubes
I Rullo di taglio per tubi
E Cortatubos
CN 管子割刀

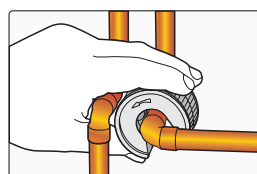

PEX	PLASTIC Al, Cu	BEARING STEEL STAL ŁOŻYSKOWA
-----	-------------------	---------------------------------

SLIDING
CARD



YATO	∅	external diameter / średnica zewnętrzna (mm)	
YT-22353	19/32" (15 mm)	48	10/100
YT-22354	23/32" (18 mm)	59	10/50
YT-22355	7/8" (22 mm)	56	10/50

GB Pipe cutter
 D Rohrschneider
 PL Obcinak do rur
 RUS Труборіз для труб

CZ Řezač trubek
 H Csővágó olló
 RO Clește pt. tăiat țevi

F Coupeur aux tubes
 I Taglia tubi PVC
 E Cortatubos
 CN 管子割刀

COLOR BOX



PEX



PLASTIC Al, Cu
 Ø 1/10"-7/8"
 Ø 3-22 mm



YATO	Ø	
YT-22318	1/10"-7/8" (3-22 mm)	100



PLASTIC Al, Cu
 Ø 1/10"-5/4"
 Ø 3-32 mm

QUICK-ADJUSTMENT
 SZYBKONASTAWNY

WITH DEBURRER
 Z GRATOWNIKIEM

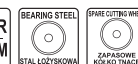

YATO	Ø	
YT-22338	1/10"-5/4" (3-32 mm)	50



PLASTIC Al, Cu
 Ø 3/8"-1-5/8"
 Ø 10-40 mm



YATO	Ø	
YT-2232	3/8"-1-5/8" (10-40 mm)	20



PLASTIC Al, Cu
 Ø 1/4"-7/4"
 Ø 6-45 mm

WITH DEBURRER
 Z GRATOWNIKIEM



YATO	Ø	
YT-2233	1/4"-7/4" (6-45 mm)	25



PLASTIC Al, Cu
 Ø 1/2"-5/2"
 Ø 14-63 mm

QUICK-ADJUSTMENT
 SZYBKONASTAWNY



YATO	Ø	
YT-2234	1/2"-5/2" (14-63 mm)	25



PLASTIC Al, Cu
 Ø 2"-5"
 Ø 50-127 mm

QUICK-ADJUSTMENT
 SZYBKONASTAWNY



YATO	Ø	
YT-2235	2"-5" (50-127 mm)	10

GB Replacement cutting wheel for pipe cutters
 D Ersatzschneidrad für Rohrschneider
 PL Zapasowe kółko tnące do obcinaka do rur
 RUS Запасной режущий диск для труборезов
 CZ Náhradní řezné kolečko na trubky frézy

H Tartalék vágókerék cső vágó
 RO Roata de schimb pt. taiere țevi
 F Molette pour coupe
 I Taglio ruote tubo taglierina
 E Rueda de corte de repuesto para cortatubos
 CN 管子割刀刀片

2 PCS
 BEARING STEEL
 STAL ŁOŻYSKOWA

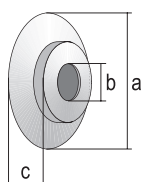

DOUBLE BLISTER

YATO	a (mm)	b (mm)	c (mm)	for/dla:	
YT-22313	18	6	4.8	YT-2233	50/300
YT-22314	26	14	7.5	YT-2232	6/108
YT-22315	18	6	4.8	YT-22338	50/300
YT-22316	27	6.3	5	YT-2234	24/288

GB Replacement cutting wheel for pipe cutters
 D Ersatzschneidrad für Rohrschneider
 PL Zapasowe kółko tnące do obcinaka do rur
 RUS Запасной режущий диск для труборезов
 CZ Náhradní řezné kolečko na trubky frézy

H Tartalék vágókerék cső vágó
 RO Roata de schimb pt. taiere țevi
 F Molette pour coupe
 I Taglio ruote tubo taglierina
 E Rueda de corte de repuesto para cortatubos
 CN 管子割刀刀片

BEARING STEEL
 STAL ŁOŻYSKOWA

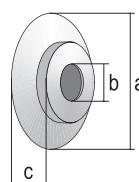

DOUBLE BLISTER

YATO	a (mm)	b (mm)	c (mm)	for/dla:	
YT-22317	44	10.6	8	YT-2235	12/144

- GB 3 in 1 mini bender
D 3 in 1 Mini-Bieger
PL Giętarka do rur
RUS Мини-трубогиб 3 в 1
CZ 3 in 1 mini ohýbačka
H Kétkezes hajlító
RO 3 in 1 mini dispozitiv de indoit teava
F Cintreuse aux tubes
I Tubo manuale bender
E 3 in 1 mini curvadoras manuales de tubos
CN 弯管器

180°	1/4"	5/16"	3/8"	SOFT STEEL MIĘKKA STAL COPPER MOSIĄDZ	Al, Cu
	6.3mm	8mm	10mm		

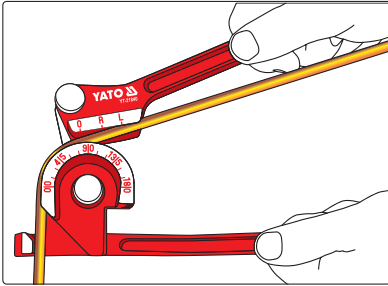

COLOR BOX

YATO	Ø	
YT-21840	1/4" (6.3 mm); 5/16" (8 mm); 3/8" (10 mm)	20

- GB Standard two handed bender
D Standard-Zweihand-Bieger
PL Giętarka do rur
RUS Стандартный двуручный трубогиб
CZ Standardní dvouruční ohýbačka
H Kétkezes hajlító
RO Dispozitiv de indoit teava
F Cintreuse aux tubes
I Tubo manuale bender
E Curvadoras manuales de tubos
CN 弯管器

180°	Al, Cu	SOFT STEEL MIĘKKA STAL COPPER MOSIĄDZ

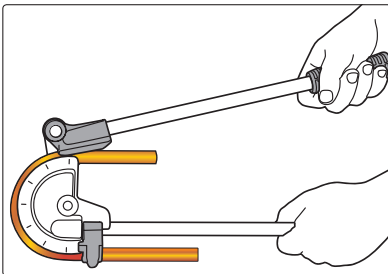

WHITE CARTON BOX & COLOR LABEL

YATO	Ø	
YT-21842	15/32" (12 mm)	20
YT-21843	9/16" (14 mm)	10
YT-21844	9/32" (15 mm)	10
YT-21845	5/8" (16 mm)	10
YT-21846	23/32" (18 mm)	10

- GB Internal pipe bending spring
D Innen-Rohrbiegefeder
PL Sprężyna wewnętrzna do gięcia rur
RUS Пружина для изгиба металлопластиковых труб, внутренняя
CZ Pružina pro ohýbání trubek vnitřní
H Belső cső hajlító rugó
RO Arc indoire pt. tevi flexibile
F Ressort de cintrage intérieur
I Curvatubi molla interna
E Muelle curvado interior para tubo
CN 倪奪粟銅

PEX AL PEX	76 cm	FLAT PROFILE PLASKI PROFIL	HOOK HAK	ZINC PLATED CYNKOWANA	SOFT STEEL MIĘKKA STAL COPPER MOSIĄDZ

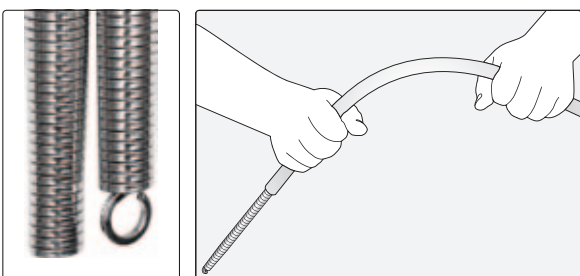

TIED ON CARD

YATO	pipe diameter / średnica rury (mm)	
YT-21850	16	25
YT-21851	20	25
YT-21852	25-26	25

- GB Hand flaring tools set
 D Handpresse zum Aufweiten von Rohren
 PL Praska do ręcznego rozszerzania rur
 RUS Пресс для ручного расширения труб
 CZ Přípravek na ruční rozšiřování konců trubek
 H Kézi csőtágító
 RO Presă manuală pt. lățirea țevilor
 F Set pour étendre les tubes
 I Presa per tubi
 E Prensa para la elongación manual de tubos
 CN 扩孔器组套

2
PCS

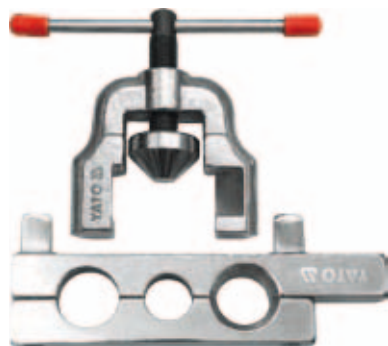
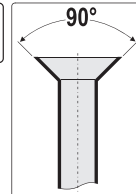

COLOR BOX



YATO	Ø (mm)	
YT-2182	22; 25; 28	20

- GB Hand flaring tools set
 D Handpresse zum Aufweiten von Rohren
 PL Praska do ręcznego rozszerzania rur
 RUS Пресс для ручного расширения труб
 CZ Přípravek na ruční rozšiřování konců trubek
 H Kézi csőtágító
 RO Presă manuală pt. lățirea țevilor
 F Set pour étendre les tubes
 I Presa per tubi
 E Prensa para la elongación manual de tubos
 CN 扩孔器组套

7
PCS

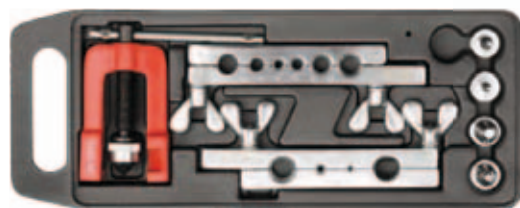
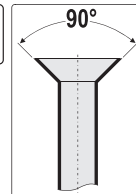

BMC & COLOR SLEEVE



YATO	Ø (mm)	
YT-2180	3; 5; 6; 8; 10; 12; 14; 15; 16; 19	10

- GB Pipe calibration tool with reamer
 D Kalibrierer mit Entgrater für Mehrschichtverbundrohr
 PL Kalibrator z gratownikiem
 RUS Калибратор пластиковый с фаскоснимателем
- CZ Kalibrator na trubky
 H Ötrétegű cső kalibráló
 RO Calibrator teava multistrat
 F Calibreur ébavureur intérieur de tubes multicouches
- I Calibratore tubo con deburrer
 E Calibrador para tubos multicapa
 CN 内外倒角整圆器

PEX
AL
PEX

WITH DEBURRER
Z GRATOWNIKIEM

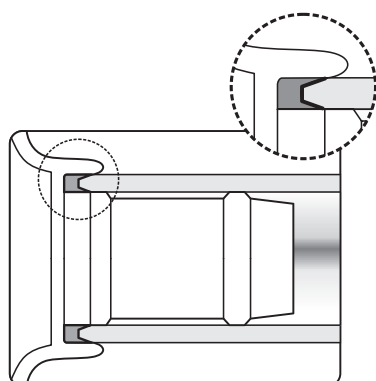

TIED ON CARD





YATO	pipe diameter / średnica rury (mm)	
YT-22373	16; 20; 25	200
YT-22374	16; 20; 26	200

- GB Gas torch
D Gasbrenner
PL Palnik gazowy
RUS Газовая паяльная лампа
CZ Plynový hořák
H Gázégó
- RO Arzător de gaz
F Bruleur à gaz
I Saldatore bruciatore a gas
E Soplete de gas
CN 火焰枪

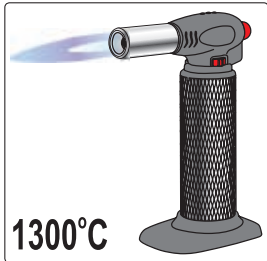

PIEZO	30 ml	60-90 min	GAS GAZ
LOCK BLOKADA	BUTANE lighter gas BUTAN (gas do zapalniczki)	CHILD PROTECTION ZABEZPECZENIE PRZED DZIECIAMI	



YATO 		
YT-36700		10/20

DOUBLE BLISTER



- GB Soldering tool set
D GaslötKolben satz
PL Lutownica gazowa z akcesoriami
RUS Газовый паяльный набор
CZ Plynova pajka souprava
H Gaz forrasztópaka készletek
RO Set ciocan de lipit cu gaz
F Fer à souder à gaz
I Saldatore a gas
E Soldador a gas con accesorios
CN 自动点火多功能瓦斯组套

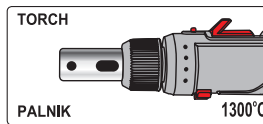
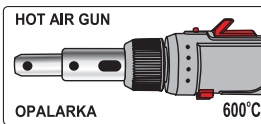
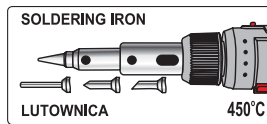

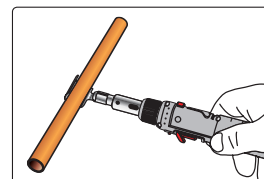
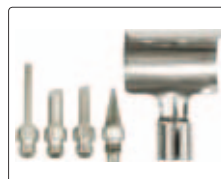
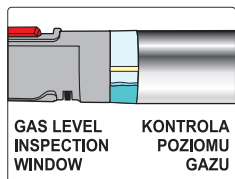

7 PCS	30-125 W	30 ml	75 min
GAS GAZ	PIEZO	LOCK BLOKADA	BUTANE lighter gas BUTAN (gas do zapalniczki)
PROPANE-BUTANE lighter gas PROPAN-BUTAN (gas do zapalniczki)	CHILD PROTECTION ZABEZPECZENIE PRZED DZIECIAMI		



PLASTIC BOX & HANGING COLOR BOX



YATO 	W	
YT-36706	30-125	6

- GB Soldering tool 3 in 1
D GaslötKolben 3 in 1
PL Lutownica gazowa 3 w 1
RUS Газовый паяльник 3-в-1
CZ Plynova pajka 3 in 1
H Gaz-forrasztópaka 3 in 1
RO Ciocan de lipit cu gaz 3 in 1
F Fer à souder à gaz
I Saldatore a gas
E Soldador de gas 3 in 1
CN 瓦斯焊接工具



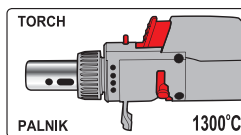
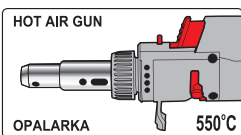
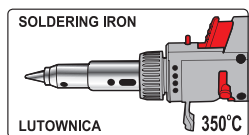

PIEZO	30~70 W	12 ml	60 min	GAS GAZ
LOCK BLOKADA	BUTANE lighter gas BUTAN (gas do zapalniczki)	PROPANE-BUTANE lighter gas PROPAN-BUTAN (gas do zapalniczki)	CHILD PROTECTION ZABEZPECZENIE PRZED DZIECIAMI	



SLIDING CARD



YATO 	W	
YT-36704	30-70	12/12

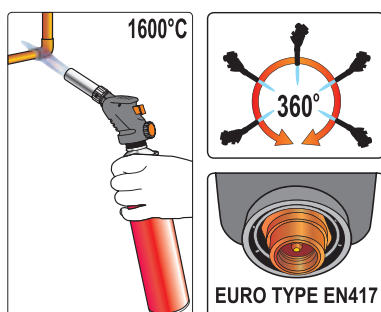

- GB Gas blow torch
D Lötbrenner
PL Palnik gazowy
RUS Газовая горелка
- CZ Plynový hořák
H Gázégó
- I Saldatore bruciatore a gas
E Soplete de gas
CN 火焰枪

PIEZO	1.28 kW	GAS GAZ	AIR POWIETRZE	LOCK BLOKADA	BUTANE BUTAN
-------	---------	---------	---------------	--------------	--------------



SLIDING CARD



YATO 	kW	
YT-36709	1.28	6/12

- GB PVC plastic pipe welder
- D Schweißgerät für thermoplastische Rohre
- PL Zgrzewarka do rur termoplastycznych
- RUS Сварочная машина для термопластиковых труба
- CZ Svářečka na termoplastické trubky
- H Hegesztő berendezés termoplasztikus csövekhez
- RO Masina de sudat tevi termoplastice
- F Soudeur en tuyauterie en PVC
- I Polifusore saldatore per tubi
- E Maquina de soldar las tubos termoplasticos
- CN 热熔器



230V~50Hz	850 W	0-300°C
Ø 16, 20, 25, 32 [mm] 40, 50, 63		



YATO	W	
YT-82250	850	2

- GB Crimping pliers for PEX-AL-PEX pipes
- D Crimpzange für die Verbindungen an den Rohren
- PL Praska do zaciskania złączek PEX-AL-PEX
- RUS Пресс-клещи для металлопластиковых труб
- CZ Lisovací kleště pro trubky PEX-AL-PEX
- H PEX-AL-PEX krimpelő eszköz
- RO Clește de sertizare pt. tevi PEX-AL-PEX
- F Pince des joints de raccordement des tuyaux PEX-AL-PEX
- I Pressa pex tubo di piegatura
- E Crimpadora para los tubos PEX-AL-PEX
- CN 液壓壓管鉗

9 PCS	PE-RT AL PE-RT	PEX AL PEX	U 16mm	U 20mm	U 25mm	U 32mm	6t =60kN	TH 16mm	TH 20mm	TH 26mm	TH 32mm
-------	----------------	------------	--------	--------	--------	--------	----------	---------	---------	---------	---------

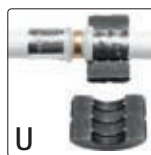
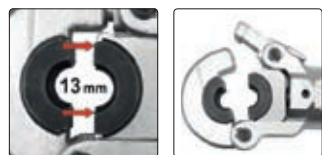

YATO		
YT-21735		2

- GB Spare die for crimping pliers
- D Ersatz Matrize für Presswerkzeug
- PL Matryca zapasowa do zaciskarki
- RUS Вкладыши для пресс-инструмента
- CZ Vyměnné čelisti
- H Présfogók
- RO Capete de presare pt. inele interschimbabile

- F Matrices empreinte pour pince
- I Dies ricambo
- E Que prensa de troquel para crimpadora
- CN 压管模块

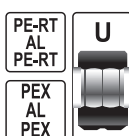

- GB Hinged pipe vice
- D Rohrschraubstock
- PL Imadlo zaciskowe do rur
- RUS Тиски для труб
- CZ Upinací svěrák na trubky
- H Satu, csőszorító

- RO Menghină pt. tevi
- F Étau de serrage à tuyaux
- I Morsa stringi tubo
- E Tornillo de apriete para tubos
- CN 管子台虎钳

S55C



for / dla: YT-21735

POLYBAG WITH HEADER

YATO	size / rozmiar U (mm)	
YT-21740	16	50
YT-21741	20	100
YT-21742	25	100
YT-21743	32	100

- GB Spare die for crimping pliers
- D Ersatz Matrize für Presswerkzeug
- PL Matryca zapasowa do zaciskarki
- RUS Вкладыши для пресс-инструмента
- CZ Vyměnné čelisti
- H Présfogók
- RO Capete de presare pt. inele interschimbabile

- F Matrices empreinte pour pince
- I Dies ricambo
- E Que prensa de troquel para crimpadora
- CN 压管模块

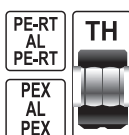

COLOR BOX



for / dla: YT-21735

POLYBAG WITH HEADER

YATO	size / rozmiar TH (mm)	
YT-21744	16	50
YT-21745	20	50
YT-21746	26	100
YT-21747	32	100

YATO	Ø (mm)	
YT-6510	60	4
YT-6511	76	2
YT-6512	90	2
YT-6513	110	1

- GB Universal quick deburrer
D Universal-Schnell-Entgrater
PL Gratownik
RUS Универсальный быстро гратосниматель
CZ Univerzální rychlé odhrotování
H Univerzális gyors sorjátlanító
- RO Debavurator rapid universal
F Ébavureur
I Utensile di sbavatura
E Desbarbador rápida universal
CN 去毛刺修边器

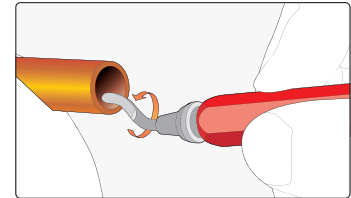

HSS M2
BODY KORPUS
Ø12mm
EXCHANGEABLE ROTATING BLADE
WYMIENNE OBRACANE OSTRZE

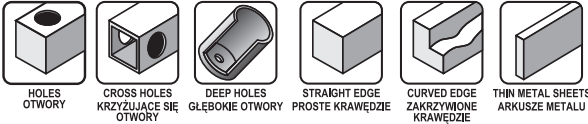

SLIDING CARD

YATO	
YT-22360	50/150

- GB Replacement blade for deburrer
D Ersatzklinge für Entgrater
PL Ostrza zapasowe do gratownika
RUS Лезвие для снятия заусенцев
CZ Náhradní čepel pro odjehlování
H Tartalék penge sorjázásához
RO Cuițit de schimb pt. debavurare
F Set le lames pour ébavureur
I Set di lame per sbavatura utensile
E Cuchilla de repuesto para desbarbar
CN 修边器刀片

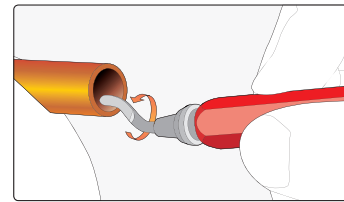

10 PCS
HSS M2
UNIVERSAL SHAPE
UNIVERSÁLNÍ KŠZTALŤ
EXCHANGEABLE ROTATING BLADE
WYMIENNE OBRACANE OSTRZE

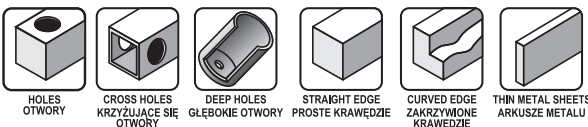

SLIDING CARD

YATO	
for / dla: YT-22360	
YT-22361	12/144

- GB Copper pipe internal brush
D Kupferrohr Innenbürste
PL Szczotka wewnętrzna do rur miedzianych
RUS Щетка для внутренней очистки труб
CZ Kartač vnitřní na měděné trubky
H Rézcső belső tisztító kefe
RO Perii de interior pt. tevi de cupru
- F Brosse aux tubes en cuivre
I Spazzola per il rame interno
E Cepillo para limpieza de tubos de cobre
CN 管子刷

STAINLESS STEEL WIRE
DRUT ZE STALI
NIEODZWIŃCZ

- GB Copper pipe brush 2 in 1
D 2-in-1 Kupferrohrbürste für Innen- und Außenreinigung
PL Szczotka do rur miedzianych 2 w 1
RUS Щетка для внутренней и внешней зачистки медных труб
CZ Kartač vnitřní a vnější na měděné trubky
- H Rézcső tisztító kefe 2 in 1
RO Perii pt. tevi de cupru 2 in 1
F Brosse aux tubes en cuivre
I Spazzola per il tubi di rame 2 in 1
E 2-en-1 cepillo para limpieza de tubos de cobre int. y ext
CN 2合1管子刷

STAINLESS STEEL WIRE
DRUT ZE STALI
NIEODZWIŃCZ



SLIDING CARD

YATO	Ø (mm)	
YT-63701	15	12/120
YT-63702	18	12/120
YT-63703	22	12/120
YT-63704	28	12/120

YATO	Ø (mm)	
YT-63705	15; 22	50/100

- GB Cleaning pad set for copper pipes
D Reinigungsvlies-satz für kupferrohre
PL Włóknina do czyszczenia rur miedzianych
RUS Губка абразивная
CZ Brusné rouno
H Tisztítószivacs
- RO Burete abraziv
F Tampons de nettoyage
I Fibra abrasiva per la pulizia de tubo di rame
E Almohadilla abrasiva
CN 件套工业洁

10 PCS
75x130 mm
FOR PIPES DO RUR
Cu
METAL FREE
NIE ZAWIERA METALU
DRY WORK
PRACA NA SUCHO
WET WORK
PRACA NA MOKRO

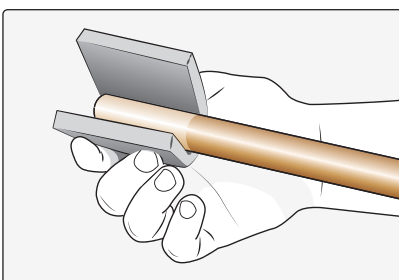

COLOR SLEEVE

YATO	size / rozmiar (mm)	
YT-63740	75x130	50



GB Tool box
D Werkzeugkasten
PL Skrzynka narzędziowa
RUS Инструментальный ящик
CZ Skříňka na nářadí
H Szerszámos láda

RO Cutie de scule
F Boîte à outils
I Cassetta degli attrezzi
E Caja de herramientas
CN 工具箱

WHITE
CARTON BOX
& COLOR LABEL

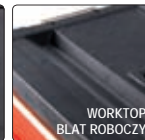

RUBBER CORNER
GUMOWY NAROZNIK

WORKTOP
BLAT ROBOCZY







390x215x130 mm
max 10 kg



390x215x60 mm
max 5 kg

390x215x60 mm
max 5 kg

YATO 	drawers / szuflady	
YT-09108	1	2

YATO 	drawers / szuflady	
YT-09107	2	2

11

GB Tool trolley
D Werkzeugkasten
PL Wózek narzędziowy 3-częściowy
RUS Тележка инструментальная
CZ Vozík na nářadí
H Szerszám kocsi
RO Instrument cărucior
F Servante d'atelier
I Armadio per utensili
E Herramienta carro
CN 工具箱



WHITE
CARTON BOX
& COLOR LABEL

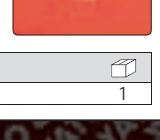
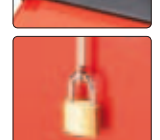
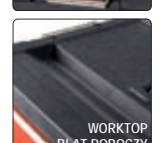

WORKTOP
BLAT ROBOCZY

MODULES
PROTECTION

ZABEZPIECZENIE
MODULÓW

RUBBER CORNER
GUMOWY NAROZNIK



420x220x150 mm
max 20 kg

390x215x130 mm
max 10 kg



410x210x280 mm
max 15 kg



420x220x150 mm
max 20 kg

390x215x60 mm
max 5 kg

390x215x60 mm
max 5 kg

410x210x280 mm
max 15 kg

YATO 		
YT-09102		1

YATO 		
YT-09101		1

GB Drawer insert / Tool set for plumbers
D Schubladeneinlage / Werkzeug-Set für Klempner
PL Wkład do szuflady / Zestaw narzędziowy dla hydraulików
RUS Вклад к выдвижному ящику / Набор инструментов для водопроводчик
CZ Vložka do zásuvky / Sada nářadí pro instalatér
H Fiókbetét / Szerszámkészlet vízvezeték-szerelő

RO Adaos la sertar / Set de instrumente pt. instalator
F Module plastique pour servante / Un ensemble d'outils pour les plombier
I Tenone per l'armadio / Tool set per idraulici
E Accesorio de cajón / Un conjunto de herramientas para fontanero
CN 水管工具組套



PLASTIC TRAY
& COLOR LABEL





 250 mm;  330 mm;
 250 mm;  15 m x 19 mm

4
PCS **CrV** **CrMo**

YATO 	
YT-55480	5







 250 mm;  3-32 mm;
 250 mm;  10 m x 12 mm
 300 mm;

5
PCS **CrV** **CrMo**

YATO 	
YT-55481	5



 63 mm;  15 m x 22 mm;
 6-45 mm;  10 m x 12 mm;

5
PCS **HSS** **8CrB**

YATO 	
YT-55482	5

12

Fastening tools Narzędzia do łączenia



Hand riveters & rivet nuts
Nitownice ręczne i nitonakrętki

240-242



Pneumatic stitching & nailing machines
Zszywacze i gwoździarki pneumatyczne

244-245



Hand riveters	
Nitownice ręczne.....	240
Hand riveting tools	
Nitownice ręczne, dźwigniowe.....	240
Hand nut tools	
Nitownice do nitonakrętek.....	241
Aluminium rivet nuts	
Nitonakrętki aluminiowe.....	242

Pneumatic staplers	
Zszywacze pneumatyczne.....	244
Pneumatic nailers	
Gwoździarki pneumatyczne.....	244
Staples	
Zszywki.....	245
Nails	
Gwoździe.....	245

Pneumatic riveters
Nitownice pneumatyczne

242



Foam guns
Pistolety do pianki

246



Staple guns & staples
Zszywacze i zszywki

243



Caulking guns
Wyciskacze do mas

247



Staple guns	
Zszywacze.....	243
Staple removers	
Rozszywacze.....	243
Staples	
Zszywki.....	243
Nails	
Gwoździe.....	243

Burners & soldering tools
Palniki i lutownice

248-249



Glue guns
Pistolety do klejenia

249



GB Hand riveter
D Blindnietzange
PL Nitownica ręczna
RUS Заклепочник
CZ Ruční nýtovačka
H Kézi pöpszegecsűzű

RO Presă de nituit manuală
F Riveteuse manuelle
I Rivettatrice manuale
E Remachadora de mano
CN 拉柳枪

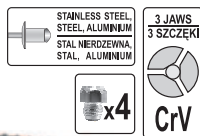

CrV

280 mm



DOUBLE BLISTER

YATO	Ø (mm)	L (mm)	
YT-3600	2.4; 3.2; 4.0; 4.8	280	6/24

GB Hand riveter
D Blindnietzange
PL Nitownica ręczna
RUS Заклепочник
CZ Ruční nýtovačka
H Kézi pöpszegecsűzű

RO Presă de nituit manuală
F Riveteuse manuelle
I Rivettatrice manuale
E Remachadora de mano
CN 拉柳枪

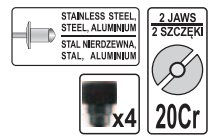

20Cr

250 mm

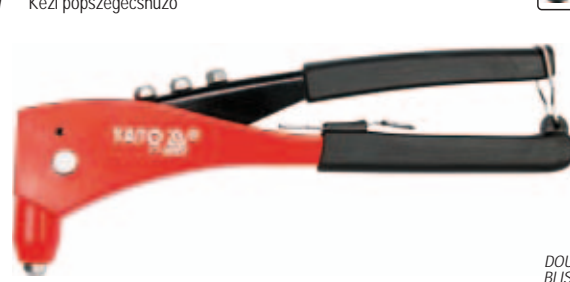

DOUBLE BLISTER

YATO	Ø (mm)	L (mm)	
YT-36007	2.4; 3.2; 4.0; 4.8	250	6/24

GB Hand riveter
D Blindnietzange
PL Nitownica ręczna
RUS Заклепочник
CZ Ruční nýtovačka
H Kézi pöpszegecsűzű

RO Presă de nituit manuală
F Riveteuse manuelle
I Rivettatrice manuale
E Remachadora de mano
CN 拉柳枪



CrMo

200 mm



COLOR BOX

YATO	Ø (mm)	L (mm)	
YT-36012	2.4; 3.2; 4.0; 4.8	200	30

GB Hand riveter
D Blindnietzange
PL Nitownica ręczna
RUS Заклепочник
CZ Ruční nýtovačka
H Kézi pöpszegecsűzű
RO Presă de nituit manuală
F Riveteuse manuelle
I Rivettatrice manuale
E Remachadora de mano
CN 拉柳枪

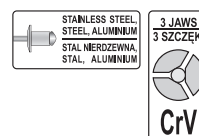

CrV

253 mm

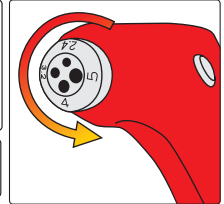

SLIDING CARD

YATO	Ø (mm)	L (mm)	
YT-36011	2.4; 3.2; 4.0; 4.8	253	12/36

GB Hand riveting tool
D Blindnietzange
PL Nitownica dźwigniowa
RUS Заклепочник
CZ Nýtovačka páková
H Emelyűs pöpszegecsűzű
RO Pöleşte pt. popnituri
F Riveteuse à levier
I Rivettatrice per rivetti a strappo
E Remachadora de palanca
CN 双把手拉柳枪

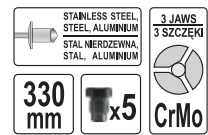

330 mm

x5

CrMo



COLOR BOX

YATO	Ø (mm)	L (mm)	
YT-3609	3.2; 4.0; 4.8; 6.0; 6.4	330	16

GB Hand riveting tool
D Blindnietzange
PL Nitownica dźwigniowa
RUS Заклепочник
CZ Nýtovačka páková
H Emelyűs pöpszegecsűzű
RO Pöleşte pt. popnituri
F Riveteuse à levier
I Rivettatrice per rivetti a strappo
E Remachadora de palanca
CN 双把手拉柳枪



328 mm

CrMo

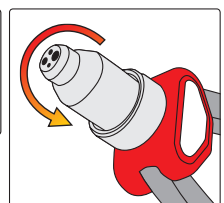

COLOR BOX

YATO	Ø (mm)	L (mm)	
YT-36092	3.2; 4.0; 4.8; 6.4	328	12

GB Hand riveting tool
D Blindnietzange
PL Nitownica dźwigniowa
RUS Заклепочник
CZ Nýtovačka páková
H Emeltyűs
RO Pclește pt. popnituri

F Riveteuse à levier
I Rivettatrice per rivetti
a strappo
E Remachadora de palanca
CN 双把手拉铆枪

380
mm

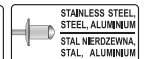

3 JAWS
3 SZCZĘKI

Tx5

CrMo



YATO	Ø (mm)	L (mm)	
YT-36095	2.4; 3.2; 4.0; 4.8; 6.4	380	12

GB Hand riveting tool
D Blindnietzange
PL Nitownica dźwigniowa
RUS Заклепочник
CZ Nýtovačka páková
H Emeltyűs
RO Pclește pt. popnituri

F Riveteuse à levier
I Rivettatrice per rivetti
a strappo
E Remachadora de palanca
CN 双把手拉铆枪

525
mm

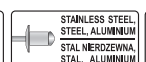

3 JAWS
3 SZCZĘKI

x5

CrV

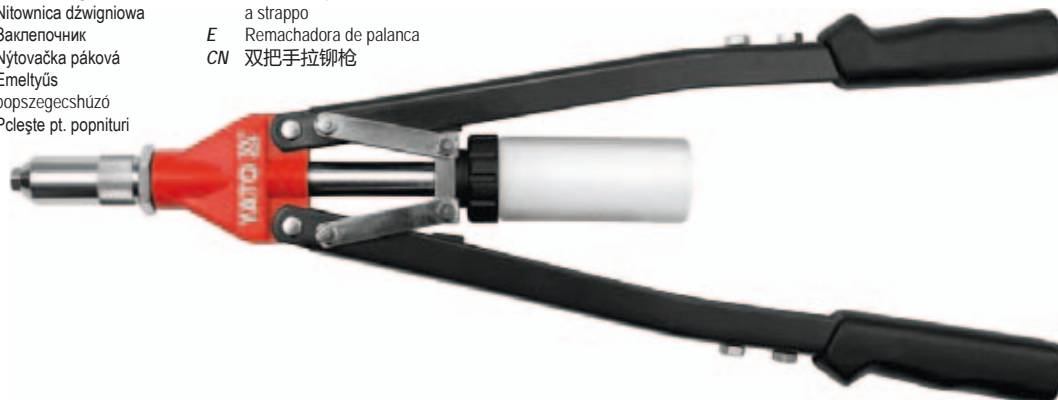

YATO	Ø (mm)	L (mm)	
YT-3610	3.2; 4.0; 4.8; 6.0; 6.4	525	12

GB Hand nut tool
D Blindnietzange
PL Nitownica ręczna do nitonakrętek
RUS Заклепочник
CZ Nýtovačka páková
H Emeltyűs popszegecshúzó
RO Pclește pt. popnituri

F Riveteuse manuelle aux écrous
I Rivettatrice mano rivetto
E Remachadora de palanca
CN 手动铆螺母枪



330
mm



0~8 mm

x6



YATO	size / rozmiar	L (mm)	
YT-3612	M3; M4; M5; M6; M8; M10	330	5

GB Hand nut tool
D Blindnietzange
PL Nitownica ręczna do nitonakrętek
RUS Заклепочник
CZ Nýtovačka páková
H Emeltyűs popszegecshúzó
RO Pclește pt. popnituri

F Riveteuse manuelle aux écrous
I Rivettatrice mano rivetto
E Remachadora de palanca
CN 手动铆螺母枪



x5

338
mm



YATO	size / rozmiar	L (mm)	
YT-36119	M5; M6; M8; M10; M12	338	6

- GB Hand nut tool
- D Blindnietzange
- PL Nitownica ręczna do nitonakrętek
- RUS Заклепочник
- CZ Nýtovačka páková
- H Emeltyűs popszegecsűző
- RO Pclește pt. popnituri
- F Riveteuse manuelle aux écrous
- I Rivettatrice mano rivetto
- E Remachadora de palanca
- CN 手动铆螺母枪



x7  CrMo

360 mm  STAINLESS STEEL, STEEL, ALUMINIUM, STAL, NERDZEWNIA, STAL, ALUMINIUM

BMC & COLOR SLEEVE



YATO	size / rozmiar	L (mm)	
YT-36128	M3; M4; M5; M6; M8; M10; M12	360	6

- GB Hand nut tool
- D Blindnietzange
- PL Nitownica ręczna do nitonakrętek
- RUS Заклепочник
- CZ Nýtovačka páková
- H Emeltyűs popszegecsűző
- RO Pclește pt. popnituri
- F Riveteuse manuelle aux écrous
- I Rivettatrice mano rivetto
- E Remachadora de palanca
- CN 手动铆螺母枪



410 mm  STAINLESS STEEL, STEEL, ALUMINIUM, STAL, NERDZEWNIA, STAL, ALUMINIUM

x7 

BMC & COLOR SLEEVE



YATO	size / rozmiar	L (mm)	
YT-36129	M3; M4; M5; M6; M8; M10; M12	410	5

- GB Threaded aluminum rivet nuts
- D Aluminium blindnietmutter
- PL Nitonakrętki aluminiowe
- RUS Алюминиевые резьбовые заклепки
- CZ Nýtovací matice hliník
- H Szegecsanya alumínium
- RO Piulițe nituibile
- F Insert fileté aluminium
- I Alluminio dadi per rivetti ciechi
- E Tuercas remachadas aluminio
- CN 铝制拉铆螺母



POLYBAG WITH HEADER



20 PCS  AI

YATO	size / rozmiar	
YT-36451	M3	125/500
YT-36452	M4	100/400
YT-36453	M5	75/300
YT-36454	M6	50/200

- GB Pneumatic riveting machine
- D Pneumatische Nietvorrichtung
- PL Nitownica pneumatyczna
- RUS Пневматический заклепочник
- CZ Pneumatická nýtovačka
- H Pneumatikus popszegecsűző
- RO Presa pneumatică de nituri
- F Riveuse pneumatique
- I Rivettatrice pneumatica
- E Máquina remachadora
- CN 气动拉铆枪

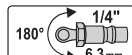

0.70 MPa  x3

54 l/min  x3



COLOR BOX



YATO	Ø (mm)	L (mm)	F (kg)	F (N)	
YT-36171	2.4; 3.2; 4.0; 4.8; 5.0	18	1060	10400	10

- GB Pneumatic riveting machine
- D Pneumatische Nietvorrichtung
- PL Nitownica pneumatyczna
- RUS Пневматический заклепочник
- CZ Pneumatická nýtovačka
- H Pneumatikus popszegecsűző
- RO Presa pneumatică de nituri
- F Riveuse pneumatique
- I Rivettatrice pneumatica
- E Máquina remachadora
- CN 气动拉铆枪



0.62 MPa  x5



COLOR BOX



- application: industry
- przeznaczenie: przemysł

YATO	Ø (mm)	L (mm)	F (kg)	F (N)	
YT-3618	2.4; 3.2; 4.0; 4.8; 6.4	16	1389	13620	6

GB Staple gun
D Tacker
PL Zszywacz tapicerski
RUS Среннеп
CZ Čalounická
sešivačka
H Kárpitos tűzőgép
RO Capsator
tapiterie

F Agrafeuse
tapissier
I Cucitrice
per tappezzerie
E Grapadora
de tapicero
CN 打钉枪

DOUBLE
BLISTER

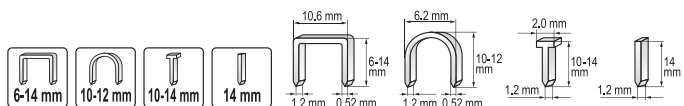

YATO	
YT-7000	12/24

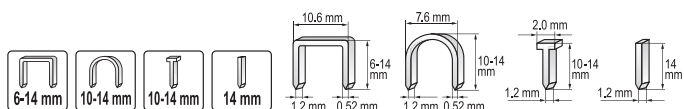

YATO	
YT-7001	12/24

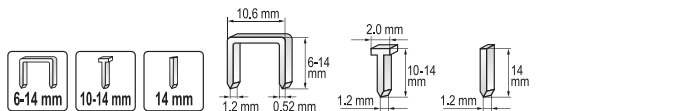

YATO	
YT-7003	6/24

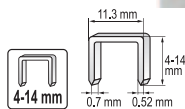

YATO	
YT-7007	12/24

GB Staple gun
D Tacker
PL Zszywacz tapicerski
RUS Среннеп
CZ Čalounická
sešivačka
H Kárpitos tűzőgép
RO Capsator tapiterie

F Agrafeuse
tapissier
I Cucitrice
per tappezzerie
E Grapadora
de tapicero
CN 打钉枪

NORMAL-MAX IMPACT FUNCTION



DOUBLE
BLISTER

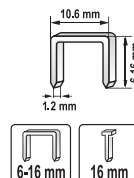

YATO	staples size / rozmiar zszywek (mm)	
YT-7005	10.6x6.0-16.0x1.2	6/24

GB Hammer tacker
D Hammer-Tacker
PL Zszywacz młotkowy
RUS Среннеп

CZ Čalounická sešivačka
H Kárpitos tűzőgép
RO Capsator tapiterie
F Agrafeuse tapissier

I Martello cucitrice
E Grapadora de martillo
CN 钉锤



DOUBLE
BLISTER

YATO	
YT-7004	10/20

GB Staple remover
D Klammern abwender
PL Rozszywacz
RUS Скобуудалитель
CZ Rozešivač
H Kapocskiszédő
RO Extractor capse
F Degrafeuse
I Fiocco di rimozione
E Quitagrapas
CN 起钉器



SLIDING
CARD

YATO	
YT-7011	25/100

GB Staples
D Heftklammern
PL Zszywki
RUS Скобы

CZ Sešivky
H Tűzőkapocs
RO Capse tapiterie
F Agrafes

HANGING
COLOR
BOX

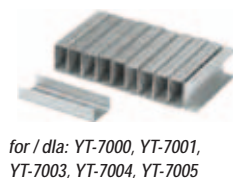

for / dla: YT-7000, YT-7001,
YT-7003, YT-7004, YT-7005

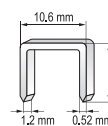

YATO L (mm)	PCS packing	
YT-7022	6	1000 50/200
YT-7023	8	1000 50/200
YT-7024	10	1000 50/100
YT-7025	12	1000 50/100
YT-7026	14	1000 50/100

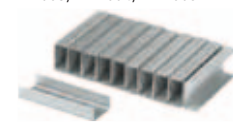

for / dla: YT-7006, YT-7007

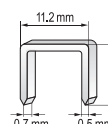

YATO L (mm)	PCS packing	
YT-7051	6	1000 60/360
YT-7052	8	1000 60/300
YT-7053	10	1000 60/240
YT-7054	12	1000 50/200
YT-7055	14	1000 40/160

GB Nails for staple gun
D Nageln für Yato Tacker
PL Gwoździe do zszywacza
RUS Гвозди для степлера
CZ Hřebíky na sešivačku
H Szegeka tűzőgéphez
RO Cuie pt. capsator
F Clous pour agrafeuses
I Chiodi per cucitrice
E Clavos para grapadoras
CN 直钉

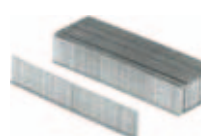

HANGING
COLOR
BOX



for / dla: YT-7000, YT-7001

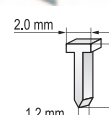

YATO L (mm)	PCS packing	
YT-7032	10	1000 50/200
YT-7033	12	1000 50/200
YT-7034	14	1000 50/200

GB Pneumatic stitching machine
 D Drucklufthefter
 PL Zszywacz pneumatyczny
 RUS Пневматический шиватель
 CZ Pneumatická sešíváčka
 H Pneumatikus tűzőgép
 RO Capsator pneumatic
 F Agrafeuse pneumatique
 I Cucitrice pneumatica
 E Engrapadora pneumática
 CN 气动码钉枪

7 bar 8-25 mm 1/4" 6.3mm

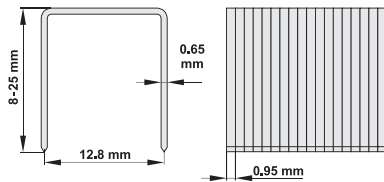

- application: industry, construction
- przeznaczenie: przemysł, budownictwo

BMC & COLOR SLEEVE



YATO	
YT-0920	5

12

GB Pneumatic nailing machine
 D Druckluftnagelgerät
 PL Gwoździarka pneumatyczna
 RUS Пневматическая гвоздильная машина
 CZ Pneumatický nástřelovač hřebíků
 H Pneumatikus szögbelevő
 RO Capsator pneumatic
 F Cloueur pneumatique
 I Chiodatrice pneumatica
 E Máquina pneumática para clavar clavos
 CN 气动码钉枪

8 bar 25-64 mm 90° 1/4" 6.3mm

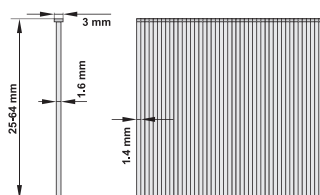

- application: industry, construction
- przeznaczenie: przemysł, budownictwo

BMC & COLOR SLEEVE



YATO	
YT-0921	5

- GB Pneumatic nailing machine
D Druckluftnagelgerät
PL Gwoździarka pneumatyczna
RUS Пневматическая гвоздильная машина
CZ Pneumatický nástřelovač hřebíků
H Pneumatikus szögbelevő
RO Capsator pneumatic
F Cloueur pneumatique
I Chiodatrice pneumatica
E Máquina pneumática para clavar clavos
CN 气动码钉枪

8 bar 50-90 mm 34° 1/4" 6.3mm

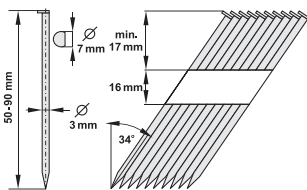

- application: industry, construction
- przeznaczenie: przemysł, budownictwo

BMC & COLOR SLEEVE

YATO	
YT-0923	2

- GB Staples
D Heftklammern
PL Zszywki
RUS Скобы
CZ Sešivky
H Tűzőkapocs
RO Capse tapiterie
F Agrafes
I Punti
E Grapas
CN 码钉

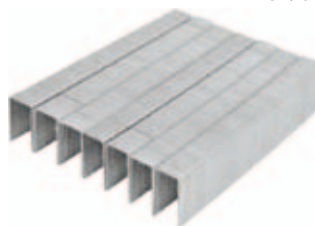
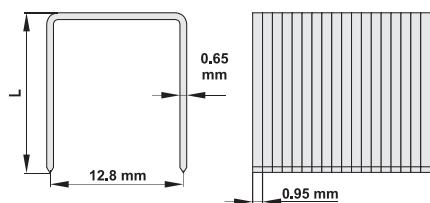

for / dla: YT-0920 COLOR BOX



1000 PCS

YATO	L (mm)	
YT-0930	8	100
YT-0931	16	50
YT-0932	25	50

- GB Nails
D Nägel
PL Gwoździe
RUS Гвозди
CZ Hřebíky
H Szeg
RO Cuie
F Clous
I Chiodi
E Clavos
CN 直钉

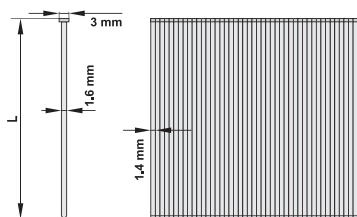

COLOR BOX



1000 PCS 90° for / dla: YT-0921

YATO	L (mm)	
YT-0941	50	20
YT-0942	64	20

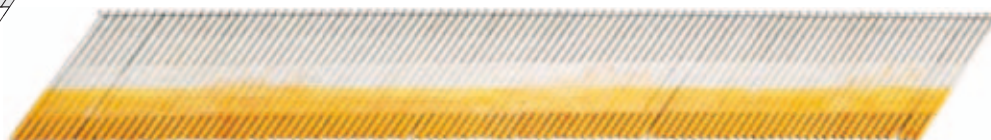
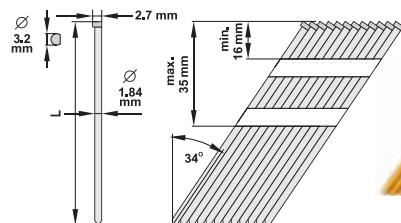

1000 PCS 34° for / dla: YT-0922

YATO	L (mm)	
YT-0938	38	20
YT-0939	50	20
YT-0940	64	20

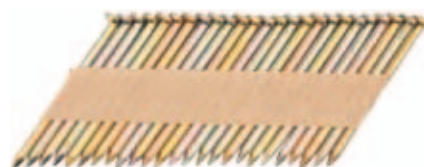
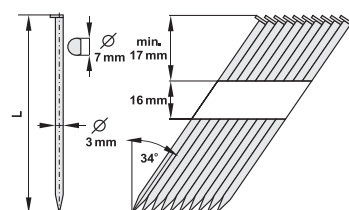

500 PCS 34° for / dla: YT-0923, YT-0927

YATO	L (mm)	
YT-0935	50	10
YT-0936	75	10
YT-0937	90	10

GB Foam gun
 D Farbspritzpistole
 PL Pistolet do pianki montażowej
 RUS Пистолет для нанесения полиуретановой пены
 CZ Pistole na montážní pěnu
 H Felrakó pisztoly, poliurethán habhoz
 RO Pistol pt. spumă



F Pistolet mousse expansive
 I Pistola per schiuma poliuretanica
 E Pistola para espuma de montaje de metal
 CN 发泡枪

COLOR BOX



**PTFE
 COATED**





YATO 	
YT-6740	10/20





YATO 	
YT-6741	10/20



YATO 	
YT-6742	10/20



YATO 	
YT-6743	20



YATO 	
YT-6745	20

300 ml

GB Caulking gun
D Kartuschenpistole
PL Wyciskacz do mas
RUS Пистолет для герметика



CZ Protlačovač na hmoty
H Masszakinyomó
RO Pistol silicon
F Pistolet à feutrer



I Pistola per silicone
E Pistola para masilla
CN 堵缝枪



225 mm

225 mm



YATO 	L (mm)	
YT-6751	225	10/20



YATO 	L (mm)	
YT-6752	225	10/20



225 mm

225 mm



YATO 	L (mm)	
YT-6753	225	6/12



YATO 	L (mm)	
YT-6754	225	10/20



225 mm

225 mm



YATO 	L (mm)	
YT-6750	225	20/40

YATO 	L (mm)	
YT-6755	225	10/20



216 mm
±60
mm

200 mm
±65
mm

YATO 	L (mm)	
YT-6756	215	6/12

YATO 	L (mm)	
YT-6757	200	10/20

- GB Gas torch
- D Gasbrenner
- PL Palnik gazowy
- RUS Газовая паяльная лампа
- CZ Plynový hořák
- H Gázégő
- RO Arzător de gaz
- F Brûleur à gaz
- I Saldatore bruciatore a gas
- E Soplete de gas
- CN 火焰枪



PIEZO	30 ml	60-90 min	GAS GAZ
LOCK BLOKADA	BUTANE lighter gas BUTAN (gas do zapalniczki)	CHILD PROTECTION ZABEZPECZENIE PRZED DZIECIAMI	

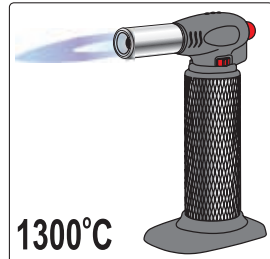

1300°C

YATO	
YT-36700	10/20

DOUBLE BLISTER



- GB Soldering tool set
- D Gaslötkolben satz
- PL Lutownica gazowa z akcesoriami
- RUS Газовый паяльный набор
- CZ Plynova pajka souprava
- H Gaz forrasztópaka készletek
- RO Set ciocan de lipit cu gaz
- F Fer à souder à gaz
- I Saldatore a gas
- E Soldador a gas con accesorios
- CN 自动点火多功能瓦斯组套

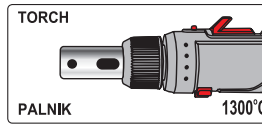
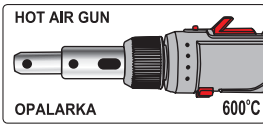
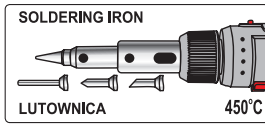

7 PCS	30-125 W	30 ml	75 min
GAS GAZ	PIEZO	LOCK BLOKADA	BUTANE lighter gas BUTAN (gas do zapalniczki)
			CHILD PROTECTION ZABEZPECZENIE PRZED DZIECIAMI

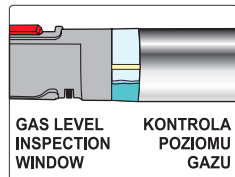

GAS LEVEL INSPECTION WINDOW KONTROLA POZIOMU GAZU

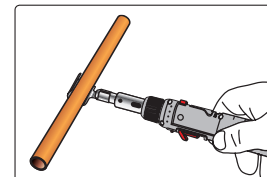
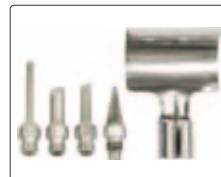

PLASTIC BOX & HANGING COLOR BOX



YATO	W
YT-36706	30-125 6

- GB Soldering tool 3 in 1
- D Gaslötkolben 3 in 1
- PL Lutownica gazowa 3 w 1
- RUS Газовый паяльник 3-в-1
- CZ Plynova pajka 3 in 1
- H Gaz-forrasztópaka 3 in 1
- RO Ciocan de lipit cu gaz 3 in 1
- F Fer à souder à gaz
- I Saldatore a gas
- E Soldador de gas 3 in 1
- CN 瓦斯焊接工具



PIEZO	30~70 W	12 ml	60 min
LOCK BLOKADA	BUTANE lighter gas BUTAN (gas do zapalniczki)	PROPANE-BUTANE lighter gas PROPAN-BUTAN (gas do zapalniczki)	CHILD PROTECTION ZABEZPECZENIE PRZED DZIECIAMI

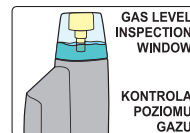
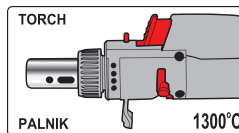
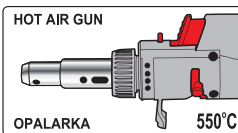
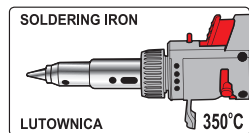

GAS LEVEL INSPECTION WINDOW KONTROLA POZIOMU GAZU

SLIDING CARD



YATO	W
YT-36704	30-70 12/72

- GB Gas blow torch
- D Lötlbrenner
- PL Palnik gazowy
- RUS Газовая горелка
- CZ Plynový hořák
- H Gázégő
- RO Arzător de gaz
- F Brûleur à gaz
- I Saldatore bruciatore a gas
- E Soplete de gas
- CN 火焰枪

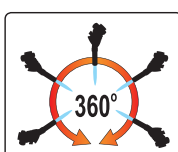
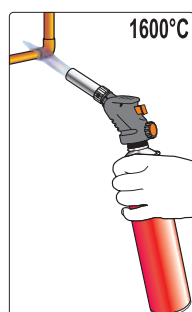

PIEZO	1.28 kW	GAS GAZ	AIR POWETRZE	LOCK BLOKADA	BUTANE BUTAN
-------	---------	---------	--------------	--------------	--------------

SLIDING CARD



YATO	kW
YT-36709	1.28 6/12

GB Soldering iron
D Lötkolben
PL Lutownica oporowa
RUS Электропаяльник
CZ Pájka odporová
H Forrasztópáka
RO Ciocan de lipit
F Fer à souder
I Saldatore a stagno
E Soldador de resistencia
CN 电烙铁

HANGING
DISPLAY
COLOR BOX

230V~
50Hz
400-520
°C
2-3
min



YATO	W	max. temperature of soldering tip / max. temperatura grotu (°C)	dimensions of soldering tip / wymiar grotu (mm)	
YT-8271	30	400	ø3.8 x 70	16
YT-8272	60	500	ø6.0 x 78	16
YT-8273	80	520	ø6.8 x 64	16

GB Desoldering pump
D Entlötlötpumpe
PL Odsysacz do snu
RUS Шприц для удаления припоя
CZ Odrpájecí sací pumpa
H Önszippantó
RO Pompa fluidor
F Pompe à étain
I Pompa aspira stagno
E Bomba desoldadora
CN 全铝手动吸锡器

SLIDING
CARD



PTFE
TIP



YATO	
YT-82742	100/400



YATO	
YT-82743	100/200



YATO	
YT-82744	50/100

GB Soldering station
D Lötstation
PL Stacja lutownicza
RUS Паяльная станция
CZ Letovací stanice
H Forrasztópáka állomás
RO Stație de lipit
F Station de soudage
I Stazione digitale di saldatura
E Estación de soldadura
CN 数显焊台

230V~
50Hz
48W
150-450
°C

7.1 mm
65 mm
LCD
DISPLAY

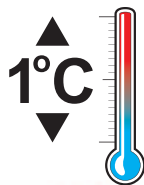

COLOR
BOX

YATO	W	
YT-82455	48	4

GB Transformer soldering gun
D Lötpestole
PL Lutownica transformatorowa
RUS Пояльник электрический
CZ Transformátorová páječka
H Forrasztópáka
RO Aparat de lipid letcon cu transformator
F Fer à souder
I Saldatore istantaneo
E Soldador transformador
CN 电烙铁

230V~
50Hz
180
W
WORKING MODE
TRZY PRACY
S2 20%

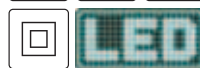

WORK LIGHT
ÓSWIETLENIE
PRACY

BMC
& COLOR
SLEEVE

YATO	W	
YT-8245	180	10

GB Electric glue gun
D Heissklebepistole
PL Pistolet do klejenia
RUS Пистолет для клея
CZ Pistole na lepení
H Ragasztópisztoly
RO Pistol pt. lipit
F Pistolet à colle
I Pistola colla
E Pistola de cola
CN 热胶枪

230V~
50Hz
35
(400)
W
150-200
°C
15
g/min

3-6
min
11 mm

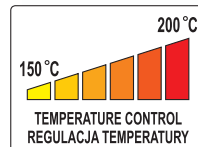
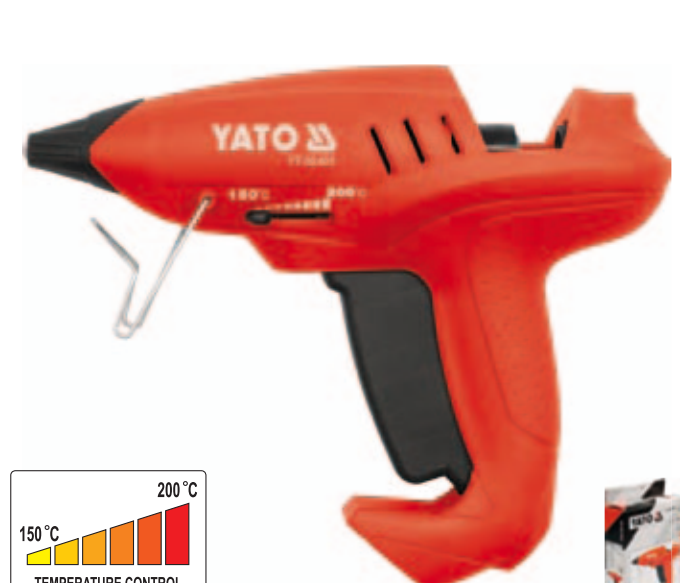

COLOR
BOX

YATO	W	diameter of glue stick średnica wkładu (mm)	capacity wydajność (g/min)	
YT-82401	35 (400)	11	15	12/24

13

Construction tools Narzędzia budowlane



Floor laminate cutters
Gilotyny do cięcia paneli podłogowych

252



Floating rules
Łaty

260



Tile cutting machines & accessories
Przyrządy do cięcia glazury i akcesoria

252-254



Knives
Noże

260



Profile gauges
Wzorniki profili

255



Electric hoists
Elektryczne wciągarki linowe

261



Scrapers
Szpachelki

255



Extension cords
Przedłużacze elektryczne

262-263



Masonry tools
Narzędzia tynkarskie i murarskie

256-257



Mixers
Mieszadła

264



Floats
Pace..... 256
Trowels
Kielnie..... 257
Plaster scrubbers
Zdzieraki do tynków..... 257

Pencils
Ołówki..... 265



Roofwork tools
Narzędzia dekarские

258-259



Carpenter's pencils
Ołówki stolarskie..... 265
Masonry pencils
Ołówki murarskie..... 265

GB Floor laminate cutter
 D Laminat-Schneider
 PL Gilotyina do cięcia paneli podłogowych
 RUS Гильотина для ламината
 CZ Nůžky na laminátové plovoucí podlahy

H Laminált padló vágógép
 RO Aparat de taiat parchet laminat
 F Guillotine pour couper les panneaux
 I Ghigliottina per taglio dei pannelli
 E Guillotina cortapaneles
 CN 木地板切割器

CARBON STEEL STAL WĘGLOWA	12 max. CUTTING THICKNESS mm GRUBOŚĆ CIĘCIA
ZINC PLATED CYNKOWANA	205 max. CUTTING LENGTH mm DŁUGOŚĆ CIĘCIA

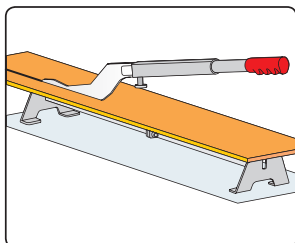
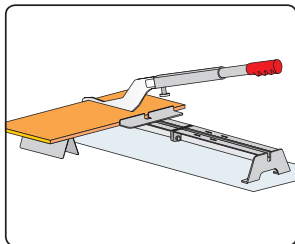
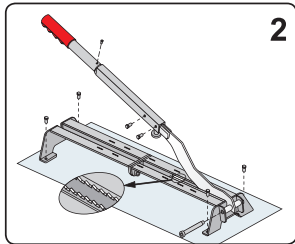
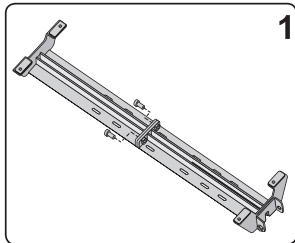

YATO	
YT-3730	4

13

GB Tile cutting machine
 D Fliesenschnidmaschine
 PL Przystroj do cięcia glazury
 RUS Плиткорез
 CZ Přístroj na řezání glazury
 H Csempevágó

RO Instrument de tăiere a glazurei
 F Coupeuse pour la céramique
 I Ghigliottina per taglio di piastrelle
 E Cortadora de gres
 CN 瓷砖切割器

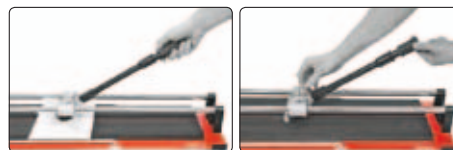

CUTTING CIECIE ±45°	14 mm max. I	22x6x2 mm
YG6X TUNGSTEN CARBIDE BY OXIDE & NIOBIA POWDER	COATED TiN POWŁOKA	



YATO	L (mm)	
YT-3701	600	2
YT-3702	700	2

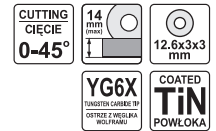

GB Tile cutting machine
D Fliesenschnidmaschine
PL Przyrząd do cięcia glazury
RUS Плиткопес
CZ Přístroj na řezání glazury
H Csempevágó

RO Instrument de tăiere a glazurei
F Coupeuse pour la céramique
I Ghigliottina per tagli di piastrelle
E Cortadora de gres
CN 瓷砖切割轮



COLOR BOX



YATO 	L (mm)	
YT-3703	630	2

GB Tile cutting wheel
D Schneiderrad
PL Kółko tnące wymienne
RUS Ролик для плиткореза

CZ Výmenné kolečko
H Cseregörgő csavarral
RO Cuțit rolă
F Molette coupante avec barre

I Lama di ricambio tondo
E Recambio de cuchillo redondo
CN 硬质合金刀片

SLIDING CARD



for / dla: YT-3700, YT-3701, YT-3702



for / dla: YT-3703

YATO 	
YT-3712	50/250

YATO 	
YT-3713	50/200

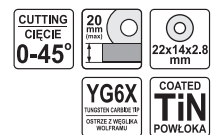

GB Tile cutting machine
D Fliesenschnidmaschine
PL Przyrząd do cięcia glazury
RUS Плиткопес
CZ Přístroj na řezání glazury
H Csempevágó
RO Instrument de tăiere a glazurei

F Coupeuse pour la céramique
I Ghigliottina per tagli di piastrelle
E Cortadora de gres
CN 瓷砖切割轮



COLOR BOX



YATO 	L (mm)	
YT-3704	600	1
YT-3705	900	1

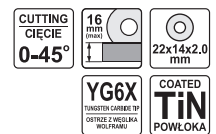

GB Tile cutting machine
D Fliesenschnidmaschine
PL Przyrząd do cięcia glazury
RUS Плиткопес
CZ Přístroj na řezání glazury
H Csempevágó

RO Instrument de tăiere a glazurei
F Coupeuse pour la céramique
I Ghigliottina per tagli di piastrelle
E Cortadora de gres
CN 瓷砖切割轮



COLOR BOX



YATO 	L (mm)	
YT-3706	500	2
YT-3707	600	2
YT-3708	800	2

GB Tile cutting wheel
D Schneiderrad
PL Kółko tnące wymienne
RUS Ролик для плиткореза

CZ Výmenné kolečko
H Cseregörgő csavarral
RO Cuțit rolă
F Molette coupante avec barre

I Lama di ricambio tondo
E Recambio de cuchillo redondo
CN 硬质合金刀片

SLIDING CARD



for / dla: YT-3704, YT-3705, YT-3706, YT-3707, YT-3708



for / dla: YT-3704, YT-3705, YT-3706, YT-3707, YT-3708

YATO 	
YT-3714	50/200

YATO 	
YT-3714	50/200

- GB Tile cutting pliers
- D Glasurzange
- PL Szczypce do cięcia i łamania glazury
- RUS Кусачки для плитки
- CZ Kleště do glazury
- H Csempefogó
- RO Cleste rupt faianta
- F Pince grès mosaïque
- I Tenaglia per piastrelle
- E Tenazas para azulejos
- CN 瓷砖钳



200 mm 

SLIDING CARD 

YATO 	L (mm)	
YT-37160	200	6/36

- GB Tile cutting pliers
- D Glasurzange
- PL Szczypce do łamania glazury
- RUS Кусачки для плитки
- CZ Kleště do glazury
- H Csempefogó
- RO Cleste rupt faianta
- F Pince grès mosaïque
- I Tenaglia per piastrelle
- E Tenazas para azulejos
- CN 瓷砖钳



200 mm 

COATED **TiN** POWLOKA

SLIDING CARD 

YATO 	L (mm)	
YT-37161	200	6/36

- GB Tile cutting pliers
- D Glasurzange
- PL Szczypce do glazury
- RUS Кусачки для плитки
- CZ Kleště do glazury
- H Csempefogó
- RO Cleste rupt faianta
- F Pince grès mosaïque
- I Tenaglia per piastrelle
- E Tenazas para azulejos
- CN 瓷砖钳



200 mm 

LONGER HANDLE BY CUTTING WHEELS

SLIDING CARD 

YATO 	L (mm)	
YT-37164	200	6/60

- GB Grout remover
- D Fugenreiniger
- PL Skrobak do fug
- RUS Скребок для швов кладки
- CZ Škrabák na spáry
- H Fugakihúzó
- RO Răzuitoare pt. rosturi
- F Gratteur pour fugues
- I Raschietto per fuga piastrelle
- E Rascador para juntas
- CN 砂浆去除器



SLIDING CARD 

YATO 	
YT-37170	10/60

- | | | |
|----------------------|---------------------------------|-------------------------|
| GB Profile gauge | H Profilsablon | I Profilato |
| D Profilmuster | RO Şablon profile | E Plantilla de perfiles |
| PL Wzornik profili | F Jauges d'épaisseurs métriques | CN 轮廓仪 |
| RUS Шаблон профилей | | |
| CZ Profilová šablona | | |



SLIDING CARD





44 mm

1.5 mm





YATO 	L (mm)	
YAT-3735	125	24/72

YATO 	L (mm)	
YAT-3736	260	10/40

- | | | | |
|---------------|-------------|-----------|------------|
| GB Scraper | RUS Шпатель | RO Şpaclu | E Espátula |
| D Spachtel | CZ Špachtle | F Riflard | CN 油灰刀 |
| PL Szpachelka | H Spatula | I Spatola | |

Mn
65



YATO 	W (mm)	
YAT-5250	30	12/240
YAT-5251	40	12/240
YAT-5252	50	12/240
YAT-5253	60	12/240
YAT-5254	80	12/240
YAT-5255	100	12/240



- | | | |
|---------------------------|------------------------|--------------------------|
| GB Trowel for silicone | CZ Špachtle na silikon | I Spatola per silicone |
| D Spachtel für Silikon | H Spachtli szilikonhoz | E Espátula para silicona |
| PL Szpachelka do silikonu | RO Spatulă pt. silicon | CN 橡塑刮板 |
| RUS Шпатель для силикона | F Spatule à silicone | |

TPR



HANGING CARD



YATO 	
YAT-5260	20/300



4
PCS

SLIDING CARD



YATO 	
YAT-5261	20/200



4
PCS

SLIDING CARD



YATO 	
YAT-5262	20/200

- GB Smooth float
D Schweizer Glättkelle
PL Paca gładka
RUS Тёрка гладкая
CZ Hladitko rovné
H Glettvas rozsdamentes
- RO Gletiera
F Truelle inoxidable
I Frattazzo liscio
E Llana para elucido
CN 不锈钢砌墙刀



• made of special cold rolled stainless steel sheet with elasticity factor up to 2000 N/mm
• części robocze ze specjalnej zimnowalcowanej blachy nierdzewnej o sprężystości do 2000 N/mm

YATO	mm	
YT-5200	270x130	30

- GB Float with teeth
D Zahnkelle
PL Paca zębata
RUS Тёрка с зубами
CZ Hladitko zuby
H Glettvas fogazott
- RO Gletiera zintata
F Truelle inoxidable
I Frattazzo dentato
E Llana dentada
CN 不锈钢砌墙刀



• made of special cold rolled stainless steel sheet with elasticity factor up to 2000 N/mm
• części robocze ze specjalnej zimnowalcowanej blachy nierdzewnej o sprężystości do 2000 N/mm

YATO	teeth / zęby	mm	
YT-5202	6x6	275x130	30
YT-5203	8x8	270x130	30
YT-5204	10x10	260x130	30

- GB Smooth float
D Schweizer Glättkelle
PL Paca tynkarska
RUS Тёрка гладкая
CZ Hladitko rovné
H Glettvas rozsdamentes
- RO Gletiera
F Truelle inoxidable
I Frattazzo
E Llana para elucido
CN 不锈钢砌墙刀



• made of special cold rolled stainless steel sheet with elasticity factor up to 2000 N/mm
• części robocze ze specjalnej zimnowalcowanej blachy nierdzewnej o sprężystości do 2000 N/mm

YATO	mm	
YT-5207	380x130	10
YT-5209	480x130	10
YT-5210	580x130	10

- GB Sharp ground float
D Steinholzglätter
PL Paca ostra
RUS Стальная острая тёрка
CZ Hladitko ocelové, špičaté
H Aljzatsimitó
- RO Gletiera cu varf ascutit
F Truelle acier
I Frattazzo acuto
E Llana pontiaguda
CN 不锈钢砌墙刀



YATO	mm	
YT-5212	500	20

- GB Smooth float
D Glättkelle
PL Paca wenecka
RUS Тёрка венецианская
CZ Hladitko rovné
H Glettvas rozsdamentes
lág fogantyúval
- RO Gletiera
F Truelle acier
I Frattazzo
E Llana puntas redondas
CN 不锈钢砌墙刀



• made of special cold rolled stainless steel sheet with elasticity factor up to 2000 N/mm
• części robocze ze specjalnej zimnowalcowanej blachy nierdzewnej o sprężystości do 2000 N/mm

YATO	mm	
YT-5214	200x80	20

- GB Abrasive float "Rasp" type
D Styropor-Schleifbrett
PL Paca ścierna do styropianu
RUS Шлифовальная тёрка "рашпиль"
CZ Škrabák na porobeton
H Csiszoló polystyrol habhoz
RO Gletiera abraziva
F Flotteur abrasif à styrofoam
- I Frattazzo abrasivo
E Llana abrasiva para polietileno
CN 磨砂型砌墙刀



YATO	mm	
YT-5218	165x370	20



- GB Stripping knife
D Flachenspachtel
PL Szpachla fasadowa
RUS Стальной шпатель
CZ Štěrka fasádní
H Spatulya fali (rákli)
RO Spaclu inox
F Spatule inoxydable
I Spatola per facciata
E Espátula de fachada
CN 剥皮刀



STAINLESS
STEEL
STAL
NIERDZEWNA

AI

• made of special cold rolled stainless steel sheet with elasticity factor up to 2000 N/mm
• części robocze ze specjalnej zimnowalcowanej blachy nierdzewnej o sprężystości do 2000 N/mm

YATO 	mm	
YT-5226	250	20
YT-5228	350	20
YT-5230	500	20

- GB Triangular trowel
D Maurerkelle
PL Kielnia trójkątna
RUS Треугольный мастерок
CZ Lžíce trojúhelníková
H Kőműves kanál háromszögletű
RO Mistrie triunghi
F Truelle
I Cazzuola punta triangolare
E Paleta triangular
CN 不锈钢砌墙刀



STAINLESS
STEEL
STAL
NIERDZEWNA

• made of special cold rolled stainless steel sheet with elasticity factor up to 2000 N/mm
• części robocze ze specjalnej zimnowalcowanej blachy nierdzewnej o sprężystości do 2000 N/mm



YATO 	mm	
YT-5234	200x190	10

- GB Trapezoid trowel
D Stukkateurkelle
PL Kielnia trapezowa
RUS Трапецидальный мастерок
CZ Lžíce zednická
H Kőműves kanál rozsdamentes
RO Mistrie
F Truelle trapézoïdale
I Cazzuola punta trapezio
E Paleta trapezoidal
CN 不锈钢砌墙刀



STAINLESS
STEEL
STAL
NIERDZEWNA

• made of special cold rolled stainless steel sheet with elasticity factor up to 2000 N/mm
• części robocze ze specjalnej zimnowalcowanej blachy nierdzewnej o sprężystości do 2000 N/mm

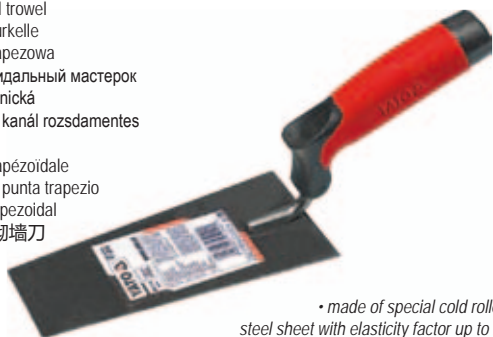

YATO 	mm	
YT-5237	120x180x80	10

- GB Trapezoid trowel
D Stukkateurkelle
PL Kielnia trapezowa
RUS Трапецидальный мастерок
CZ Lžíce zednická
H Kőműves kanál rozsdamentes
RO Mistrie
F Truelle trapézoïdale
I Cazzuola punta trapezio
E Paleta trapezoidal
CN 不锈钢砌墙刀



STAINLESS
STEEL
STAL
NIERDZEWNA

• made of special cold rolled stainless steel sheet with elasticity factor up to 2000 N/mm
• części robocze ze specjalnej zimnowalcowanej blachy nierdzewnej o sprężystości do 2000 N/mm



YATO 	mm	
YT-5240	165x80x55	20

- GB Stucco trowel
D Gipserspachtel
PL Kielnia „Podkowa”
RUS Штукатурный мастерок
CZ Lžíce vymazávací
H Gittelő kanál rozsdamentes
RO Mistrie
F Truelle en stuc
I Cazzuola punta tonda
E Paleta para estucado
CN 不锈钢砌墙刀



STAINLESS
STEEL
STAL
NIERDZEWNA

• made of special cold rolled stainless steel sheet with elasticity factor up to 2000 N/mm
• części robocze ze specjalnej zimnowalcowanej blachy nierdzewnej o sprężystości do 2000 N/mm

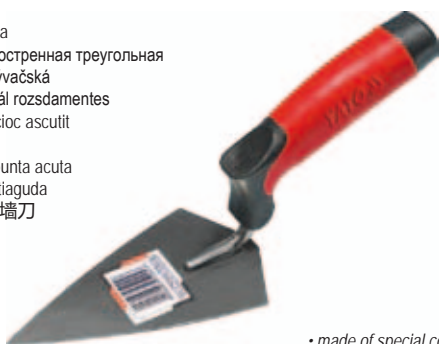

YATO 	mm	
YT-5242	100x130	20
YT-5243	80x110	20

- GB Stucco sharp trowel
D Putzkelle
PL Kielnia ostra
RUS Кельма заостренная треугольная
CZ Lžíce pokrývačská
H Gittelő kanál rozsdamentes
RO Mistrie cu cioc ascuțit
F Truelle
I Cazzuola punta acuta
E Paleta pontiaguda
CN 不锈钢砌墙刀



STAINLESS
STEEL
STAL
NIERDZEWNA



• made of special cold rolled stainless steel sheet with elasticity factor up to 2000 N/mm
• części robocze ze specjalnej zimnowalcowanej blachy nierdzewnej o sprężystości do 2000 N/mm

YATO 	mm	
YT-5245	135x80	20

- GB Plaster scrubber
D Alu-Rabott
PL Zdzierak do tynków
RUS Треугольный мастерок для каменщиков
CZ Škrabák
H Vakolat gyalu alu késes
RO Gletiera abraziva
F Enleveur du badigeon
I Utensile per sgrassare
E Rascador para enlucido
CN 石膏去除器



AI

YATO 	mm	
YT-5247	450x90	25

GB Tin snips
D Blechscherer
PL Nożyce do cięcia blachy
RUS Ножницы по металлу

CZ Nůžky na plech
H Lemezvágó olló
RO Foarfece pt. tablă
F Cisaille à tôle

I Cesoie per lamiera
E Tijeras para chapas
CN 铁皮剪

SLIDING CARD



DROP FORGED KUTE

HRC 58-61



LEFT CUT
CIECIE LEWE

YATO	L (mm)	cutting length (mm)	cutting capacities (mm)				6/24
			copper	cold-rolled steel	hard steel HRC35	stainless steel 304	
YT-1900	260	30	0.94	0.78	0.60	0.45	6/24



RIGHT CUT
CIECIE PRAWIE

YATO	L (mm)	cutting length (mm)	cutting capacities (mm)				6/24
			copper	cold-rolled steel	hard steel HRC35	stainless steel 304	
YT-1901	260	30	0.94	0.78	0.60	0.45	6/24



LEFT CUT
CIECIE LEWE

YATO	L (mm)	cutting length (mm)	cutting capacities (mm)				6/24
			copper	cold-rolled steel	hard steel HRC35	stainless steel 304	
YT-1902	300	50	0.94	0.78	0.60	0.45	6/24



STRAIGHT CUT
CIECIE PROSTE

YATO	L (mm)	cutting length (mm)	cutting capacities (mm)				6/36
			copper	cold-rolled steel	hard steel HRC35	stainless steel 304	
YT-1925	225	52	0.94	0.78	0.60	0.45	6/36

GB Tin snips
D Blechscherer
PL Nożyce do cięcia blachy
RUS Ножницы по металлу
CZ Nůžky na plech
H Lemezvágó olló

RO Foarfece pt. tablă
F Cisaille à tôle
I Cesoie per lamiera
E Tijeras para chapas
CN 铁皮剪



SLIDING CARD



HRC 60-62

CrMo

90°

SERRATED EDGES
ZĄBKOWANA KRAWĘDZ OSTRZY



LEFT CUT
CIECIE LEWE



RIGHT CUT
CIECIE PRAWIE

YATO	L (mm)	cutting length (mm)	cutting capacities (mm)				6/36
			copper	cold-rolled steel	hard steel HRC35	stainless steel 304	
YT-1913	225	30	0.78	0.53	0.46	0.36	6/36

YATO	L (mm)	cutting length (mm)	cutting capacities (mm)				6/36
			copper	cold-rolled steel	hard steel HRC35	stainless steel 304	
YT-1914	225	30	0.78	0.53	0.46	0.36	6/36

GB Portable nothers
D Schere zum Ausschneiden von Ecken
PL Nożyce do wycinania naroży
RUS Ножницы для наружных углов
CZ Nůžky na vystřihování rohů
H Sarokkivágó olló
RO Foarfeca pt. taierea colturilor

F Ciseaux pour le coupage des coins
I Cesoie per taglio reggetta in angoli
E Tijera para esquinas
CN 截角器

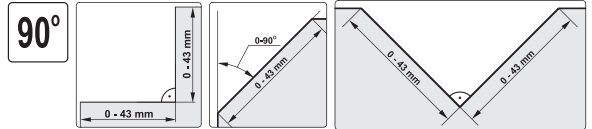

YATO	L (mm)	Box
YT-1939	300	15

GB Straight pliers
D Zange zum Blechbiegen
PL Kleszcze do gięcia blach
RUS Клещи с тупым ножом для жести
CZ Kleště na ohýbání plechu
H Falcfogó
RO Cleste pt. indoirea tablei
F Pince à fléchir la tôle

I Taglie per la lamiera
E Tenazas para doblar hojalata
CN 钣金钳

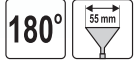

YATO	L (mm)	Box
YT-5416	280	10/20

YATO	L (mm)	Box
YT-5417	260	10/20

YATO	L (mm)	Box
YT-5415	280	10/20

GB Single seam clencher
D Klemme für Einfachfalz
PL Zaciskacz rąbka pojedynczego
RUS Зажим отдельного фальца
CZ Uzavírač jednoduché drážky
H Duplafalclezáró fogó
RO Clema pt. falt simplu
F Plieur manuel tôle (rebord singulier)
I Griffa
E Pinza para costura individual
CN 屋顶施工工具

GB Double seam clencher
D Klemme für Doppelfalz
PL Zaciskacz rąbka podwójnego
RUS Зажим двойного фальца
CZ Uzavírač dvojité drážky
H Duplafalclezáró fogó
RO Clema pt. falt dublu
F Plieur manuel tôle (rebord double)
I Griffa
E Pinza para costura doble
CN 屋顶施工工具

GB Eaves turner
D Kantvorrichtung für Dachtraufe
PL Kantownik okapu
RUS Угольник навеса
CZ Ohýbačka okapnice
H Ereszperemező fogó
RO Cornier streasina
F Cintreuse d'avant-toit
I Griffa
E Volteador de alero
CN 屋顶施工工具

GB Eaves clencher
D Klemme für Dachtraufe
PL Zaciskacz okapu
RUS Зажим навеса
CZ Uzavírač okapnice
H Ereszperemező fogó
RO Clema pt. streasina
F Cintreuse d'avant-toit
I Griffa
E Pinza para alero
CN 屋顶施工工具



YATO	Ø (mm) pipe / rurki	mm	Box
YT-5400	18	480x220	5



YATO	Ø (mm) pipe / rurki	mm	Box
YT-5402	18	480x220	5



YATO	Ø (mm) pipe / rurki	mm	Box
YT-5404	18	450x200	5



YATO	Ø (mm) pipe / rurki	mm	Box
YT-5405	18	450x200	5

GB Drainpipe hooks bender
D Biegewerkzeug für Dachrinnenhaken
PL Zaginacz haków rynnowych
RUS Прибор для загибания крюков для водосточных желобов
CZ Ohýbačka okapových háků
H Ereszcsatorna-tartóvas hajlító
RO Dispozitiv pt. îndoiti cârlige burlan
F Cintreuse pour crochets de gouttière
I Utensile per gancio
E Herramienta para doblar los ganchos para canalones
CN 弯管器



YATO	L (mm)	Box
YT-5410	680	4

GB Rectangular floating rule
D Setzlatte 2 Libellen
PL Łata murarska
RUS Правило-уровень

CZ Lat' zednická s libelami
H Őlesléc, téglalap keresztmetszetű
RO Dreptar cu 2 bule
F Niveau à bulle

I Livella
E Nivel de albanil
CN 刮板



ACCURACY
0.057"
= 1 mm/m
2
PRECISION
MALS
LIBELLE



YATO	L (mm)	
YT-3071	1500	10
YT-3072	2000	10
YT-3073	2500	10
YT-3074	3000	10



YATO	L (mm)	
YT-3076	1500	10
YT-3077	2000	10
YT-3078	2500	10
YT-3079	3000	10

GB Trapezoid floating rule
D Abziehlatte mit Trapezprofil
PL Łata tynkarska
RUS Правило трапециевидное

CZ Lat' maliřská
H Őlesléc, trapézoid keresztmetszetű
RO Dreptar trapezoidal
F Niveau à bulle

I Livella trapezoidale
E Nivel de albanil
CN 梯形刮板



YATO	L (mm)	
YT-3081	1500	10
YT-3082	2000	10
YT-3083	2500	10
YT-3084	3000	10

GB Knife for roofing paper
D Messer zum Schneiden von Pappe
PL Nóż do cięcia papy
RUS Нож для резки рубероида
CZ Nůž k řezání lepenky
H Kátrányapírvágó olló
RO Cutter pt. tăierea cartonului asfaltat
F Couteau pour carton
I Coltello per tagliare cartone bituminoso
E Cuchilla para cortar cartón alquitranado
CN 多功能刀



90 mm
STAINLESS
STEEL
STAL
NERDZEWA

SLIDING
CARD

YATO	L (mm)	
YT-7620	230	12/60

GB Knife for mineral wool
D Messer zum Schneiden von Bausisolierungen
PL Nóż do cięcia izolacji budowlanych
RUS Нож для резки строительной изоляции

CZ Nůž k řezání stavebních izolačních hmot
H Kés épületszigetelés vágásához
RO Cutter pt. tăierea izolațiilor
F Couteau pour isolants

I Coltello per tagliare l'isolamento di costruzione
E Cuchilla para cortar aislamiento de construcción
CN 多功能刀

SLIDING
CARD

350 mm
STAINLESS
STEEL
STAL
NERDZEWA

YATO	L (mm)	
YT-7623	500	10/50

335 mm
STAINLESS
STEEL
STAL
NERDZEWA

YATO	L (mm)	
YT-7624	480	10/50

GB Thermal knife for polystyrene foam
D Thermesser für Styropor
PL Nóż termiczny do styropianu
RUS Термонож для пенопласта

CZ Termický nůž na pěnový polystyrén
H Polisztirol vágó hőkés
RO Cuțit termic pt. stiropian
F Couteau thermique à styrofoam

I Coltello termico per polistirolo
E Cuchilla térmica para poliestireno
CN 热切割刀

230V~
50Hz

220
W

70-450
°C

POLYSTYRENE
STYROPIAN

POLYPROPYLENE
POLIPROPILEN

PVC

LED



COLOR BOX

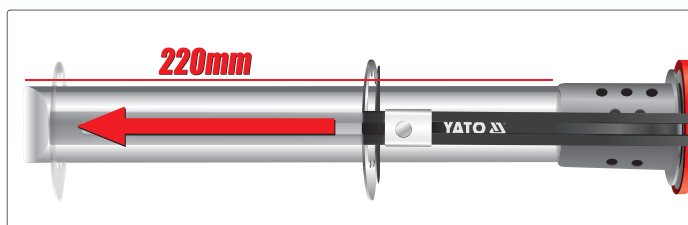
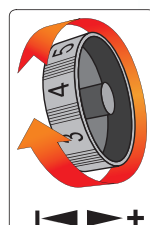

YATO	W	L (mm)	
YT-82190	220	220	10

























- GB Electric hoist
- D Elektro-Seilwinde
- PL Elektryczny wciągnik linowy
- RUS Электрическая канатная лебёдка
- CZ Elektrický naviják kladkostroj
- H Elektromos csőrő
- RO Troliu electric cu cablu
- F Treuil électrique à corde
- I Verricello elettrico
- E Cabria eléctrica de cuerdas
- CN 电动葫芦



COLOR BOX

230V~
50Hz



500 W		
YATO		
YT-5901	2	2
		
	125 kg	250 kg
550 W		
YATO		
YT-5902	2	2
		
	150 kg	300 kg
900 W		
YATO		
YT-5904	2	2
		
	250 kg	500 kg
1050 W		
YATO		
YT-5905	2	2
		
	300 kg	600 kg

GB Rubber protection extension cord
 D Gummiisolierte Verlängerungsschnur
 PL Przedłużacz w osłonie gumowej
 RUS Удлинитель с резиновой изоляцией
 CZ Prodlužovací kabel s gumovou izolací
 H Gumi szigetelésű hosszabbító
 RO Cablu prelungitor cauciuc
 F Rallonge électrique
 I Prolunga in gomma
 E Cable de extensión con protección de caucho
 CN 电缆延长线

IP44 16A
 CABLE 3G1.5 mm²
 H05RR-F KABEL
 E & F TYPE / TYP E TYPE / TYP
 230V~50Hz



YATO	L (m)	
YT-81021	10	8
YT-81022	20	4
YT-81023	30	4
YT-81024	40	2

GB Rubber protection extension cord
 D Gummiisolierte Verlängerungsschnur
 PL Przedłużacz w osłonie gumowej
 RUS Удлинитель с резиновой изоляцией
 CZ Prodlužovací kabel s gumovou izolací
 H Gumi szigetelésű hosszabbító
 RO Cablu prelungitor cauciuc
 F Rallonge électrique
 I Prolunga in gomma
 E Cable de extensión con protección de caucho
 CN 电缆延长线

IP44 16A
 CABLE 3G2.5 mm²
 H05RR-F KABEL
 E & F TYPE / TYP E TYPE / TYP
 230V~50Hz



COLOR BOX

YATO	L (m)	
YT-8100	20	4
YT-8101	30	2
YT-8102	40	2

13

GB Rubber protection extension cord
 D Gummiisolierte Verlängerungsschnur
 PL Przedłużacz w osłonie gumowej
 RUS Удлинитель с резиновой изоляцией
 CZ Prodlužovací kabel s gumovou izolací
 H Gumi szigetelésű hosszabbító
 RO Cablu prelungitor cauciuc
 F Rallonge électrique
 I Prolunga in gomma
 E Cable de extensión con protección de caucho
 CN 电缆延长线

IP44 16A
 CABLE 3G1.5 mm²
 H07RN-F KABEL
 E & F TYPE / TYP E TYPE / TYP
 230V~50Hz



YATO	L (m)	
YT-8111	5	16
YT-8112	10	8

GB Rubber protection extension cord
 D Gummiisolierte Verlängerungsschnur
 PL Przedłużacz w osłonie gumowej
 RUS Удлинитель с резиновой изоляцией
 CZ Prodlužovací kabel s gumovou izolací
 H Gumi szigetelésű hosszabbító
 RO Cablu prelungitor cauciuc
 F Rallonge électrique
 I Prolunga in gomma
 E Cable de extensión con protección de caucho
 CN 电缆延长线

IP44 16A
 CABLE 3G1.5 mm²
 H07RN-F KABEL
 E & F TYPE / TYP E TYPE / TYP
 230V~50Hz



YATO	L (m)	
YT-8116	10	4
YT-81162	20	4

GB Cable reel
D Kabeltrommel
PL Przedłużacz zwijany
RUS Удлинитель электрический
CZ Bubnový prodloužovač
H Kábeldob
RO Prelungitor pe tambur
F Rallonge électrique sur tambour enrouleur
I Avvolgicavo con bobina
E Cable de prolongación de tambor
CN 电缆延长线



IP44 16A
CABLE HO5RR-F KABEL 3G1.5 mm² CABLE (KABEL)
E & F TYPE / TYP E TYPE / TYP
230V~50Hz

• $P_{max} = 1000\text{ W}$ coiled
 $P_{max} = 1000\text{ W}$ zwinięty
• $P_{max} = 3000\text{ W}$ uncoiled
 $P_{max} = 3000\text{ W}$ rozwinięty

YATO	L (m)	
YT-81052	20	2
YT-81053	30	2
YT-81054	40	2

GB Cable reel
D Kabeltrommel
PL Przedłużacz zwijany
RUS Удлинитель электрический
CZ Bubnový prodloužovač
H Kábeldob
RO Prelungitor pe tambur
F Rallonge électrique sur tambour enrouleur
I Avvolgicavo con bobina
E Cable de prolongación de tambor
CN 电缆延长线



IP44 16A
CABLE HO5RR-F KABEL 3G2.5 mm² CABLE (KABEL)
E & F TYPE / TYP E TYPE / TYP
PLASTIC REEL BEBEN PLASTIKOVY 230V~50Hz

• $P_{max} = 1200\text{ W}$ coiled
 $P_{max} = 1200\text{ W}$ zwinięty
• $P_{max} = 3600\text{ W}$ uncoiled
 $P_{max} = 3600\text{ W}$ rozwinięty

YATO	L (m)	
YT-8106	30	1
YT-8107	40	1
YT-8108	50	1

GB Drum power extension cord
D Verlängerungstrommel für Kraftstrom
PL Przedłużacz bębnowy silowy
RUS Силовой удлинитель барабанного типа
CZ Prodloužovací kabel silový na bubnu
H Háromfázisú hosszabbító dob
RO Derulator cu tambur
F Rallonge électrique sur tambour enrouleur
I Avvolgicavo di forza
E Cilindro de extensión de fuerza
CN 电缆延长线



IP44 ~400V ~230V
CABLE HO7RN-F KABEL 5G2.5 mm² CABLE (KABEL)
3P+N+E 3P+N+E 2x 2P+E

• ~230V; 2P+E
 $P_{max} = 1200\text{ W}$ coiled
 $P_{max} = 1200\text{ W}$ zwinięty
 $P_{max} = 3000\text{ W}$ uncoiled
 $P_{max} = 3000\text{ W}$ rozwinięty

• ~400V; 3P+N+E
 $P_{max} = 3000\text{ W}$ coiled
 $P_{max} = 3000\text{ W}$ zwinięty
 $P_{max} = 9000\text{ W}$ uncoiled
 $P_{max} = 9000\text{ W}$ rozwinięty

YATO	L (m)	
YT-8120	25	1

GB Spiral bar mixer CZ Spirálové míchadlo drátové I Mescolatore spirale
 D Rundstabrührer für klebrige, geschmeidige Materialien H Spirális pálcás keverő E Agitadore pala/cinta
 PL Mieszadło spiralne prętowe F Malaxor pt. vopsea CN 搅拌器
 RUS Краскомешалка



- application: powder materials, general-purpose adhesives, gypsum surface finishing mixes, epoxy grouts
- zastosowanie: materiały sypkie, gotowe zaprawy klejowe, masy szpachlowe, zaprawy do spoinowania

YATO	Ø (mm)	L (mm)	shank / uchwył	max. mixing capacity / max. wydajność mieszania (kg)	
YT-5490	85	410	HEX	4-9	30
YT-5491	100	600	HEX	6-16	16
YT-5492	85	450	SDS+	4-9	30
YT-5493	100	600	SDS+	6-16	16

GB Spiral mixer CZ Spirálové míchadlo I Mescolatore spirale
 D Rondenrührer für dünnflüssige Materialien H Spirális keverő E Agitador de cinta helicoidal
 PL Mieszadło spiralne F Malaxeur spiral CN 搅拌器
 RUS Краскомешалка



- application: emulsion paints, acrylic paints, lacquers, stains, other liquid materials
- zastosowanie: farby emulsyjne, farby akrylowe, lakiery, bejce, inne materiały płynne

YATO	Ø (mm)	L (mm)	shank / uchwył	max. mixing capacity / max. wydajność mieszania (kg)	
YT-5494	80	400	HEX	5-10	30
YT-5496	100	600	SDS+	15-30	20

GB Double spiral mixer CZ Spirálové míchadlo dvojité I Mescolatore a doppia spirale
 D Wendelrührer für klebrige, zähe Materialien H Dupla spirális keverő E Agitador de cinta helicoidal doble
 PL Mieszadło spiralne podwójne F Malaxeur spiral double CN 搅拌器
 RUS Краскомешалка



- application: general-purpose adhesives, masonry mortars, jointless floors, thin-layer mineral plasters, gypsum surface finishing mixes, isolation masses
- zastosowanie: zaprawy klejowe, zaprawy murarskie, jastrych, tynki strukturalne, masy szpachlowe, masy izolacyjne

YATO	Ø (mm)	L (mm)	shank / uchwył	max. mixing capacity / max. wydajność mieszania (kg)	
YT-5497	70	400	HEX	5-10	20
YT-5499	100	600	HEX	10-20	16
YT-5500	120	600	HEX	15-25	14
YT-5501	100	600	SDS+	10-20	16
YT-5502	120	600	SDS+	15-25	14
YT-5503	120	600	M14	15-25	14
YT-5504	160	600	M14	20-30	8

GB Triple spiral mixer CZ Spirálové míchadlo trojité I Mescolatore a triplo spirale
 D Wendelrührer für schwere, zähe Materialien H Tripla spirális keverő E Agitador de cinta helicoidal triple
 PL Mieszadło spiralne potrójne F Malaxeur spiral triple CN 搅拌器
 RUS Краскомешалка



- application: mortars, concrete, plasters, other semi-fluid materials with sand or gravel filling
- zastosowanie: zaprawy, beton, tynki, inne półpłynne, lepkie materiały z wypełnieniem piaskowym lub żwirowym

YATO	Ø (mm)	L (mm)	shank / uchwył	max. mixing capacity / max. wydajność mieszania (kg)	
YT-5505	100	600	HEX	10-20	16
YT-5506	120	600	SDS+	15-25	12
YT-5507	120	600	M14	15-25	12
YT-5508	160	600	M14	20-30	8

GB Carpenter's pencil
D Zimmermannsbleistifte
PL Ołówek stolarski
RUS Карандаш столярный

CZ Tesařská tužka
H Asztalos ceruza
RO Creion de tâmplărie
F Crayon menuisier

I Matita per falegnami
E Lapiz de carpintero
CN 木工铅笔

COLOR BOX



144 PCS HB



YATO	L (mm)	W (mm)	PCS packing	
YT-6925	245	15	144	8



YATO	L (mm)	W (mm)	PCS packing	
YT-6926	245	12	144	8

GB Masonry pencil
D Maurerbleistift
PL Ołówek murarski
RUS Карандаш каменщика

CZ Tužka zednická
H Kőműves keverő
RO Creion
F Crayon maçon

I Matita per muratori
E Lápiz de albañil
CN 木工铅笔

COLOR BOX



144 PCS HB



YATO	L (mm)	W (mm)	PCS packing	
YT-6927	245	12	144	8

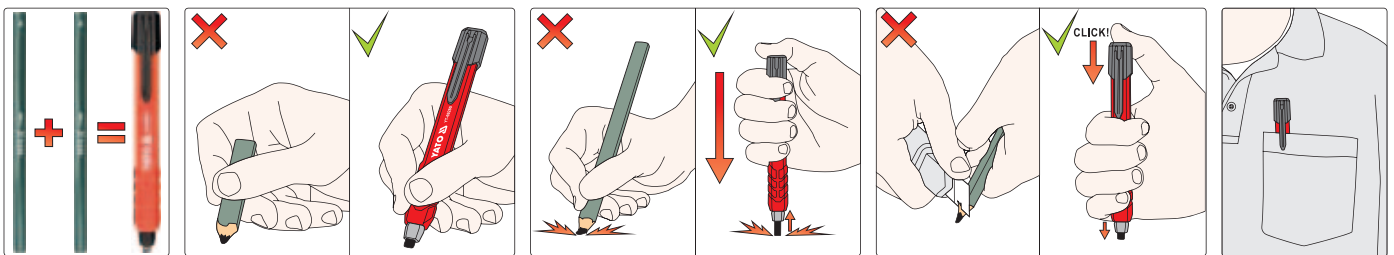

GB Automatic carpenters / masonry pencil
D Tischler- und Maurer-Druckstift
PL Ołówek stolarski / murarski automatyczny
RUS Автоматический столярный карандаш / карандаш каменщика

CZ Stolařská / zednická tužka automatická
H Asztalos / kőműves töltőceruza
RO Creion de tâmplărie / zidărie mecanic
F Crayon menuisier / maçon automatique

I Matita per falegnami e carpentieri
E Lápiz automático de carpintero / albañil
CN 自动木工铅笔

HB



YATO	
YT-69280	50/1000

GB Automatic carpenters / masonry pencil with spare leads
D Tischler- und Maurer-Druckstift + zusätzliche Bleistiftmine
PL Ołówek stolarski / murarski automatyczny + dodatkowe grafity

RUS Автоматический столярный карандаш / карандаш каменщика + дополнительный графит
CZ Stolařská / zednická tužka automatická + náhradní tuha
H Asztalos / kőműves töltőceruza + tartalék grafit
RO Creion de tâmplărie / zidărie mecanic + grafit adițional

F Crayon menuisier / maçon automatique
I Matita per falegnami e carpentieri ricaricabile
E Lápiz automático de carpintero / albañil + mina adicional
CN 自动木工铅笔组套

1+5 LEADS WKŁADY HB

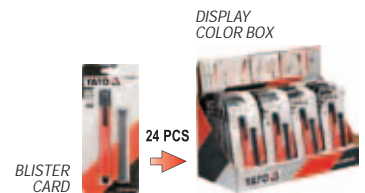

YATO	
YT-69281	144

GB Lead HB
D Bleistiftmine HB
PL Grafit HB
RUS Графит HB
CZ Tuha HB
H Grafit HB

RO Grafit HB
F Mine HB
I Grafite HB
E Mina HB
CN 自动木工铅笔笔芯

PLASTIC TUBE



5 LEADS WKŁADOW HB



for / dla: YT-69280, YT-69281

YATO	
YT-69285	20/1000

GB Lead H2
D Bleistiftmine H2
PL Grafit H2
RUS Графит H2
CZ Tuha H2
H Grafit H2

RO Grafit H2
F Mine H2
I Grafite H2
E Mina H2
CN 自动木工铅笔笔芯

PLASTIC TUBE



5 LEADS WKŁADOW H2



for / dla: YT-69280, YT-69281

YATO	
YT-69286	20/1000

GB Lead HB
D Bleistiftmine HB
PL Grafit HB
RUS Графит HB
CZ Tuha HB
H Grafit HB

RO Grafit HB
F Mine HB
I Grafite HB
E Mina HB
CN 自动木工铅笔笔芯

PLASTIC TUBE



5 LEADS WKŁADOW HB WHITE BIAŁY



for / dla: YT-69280, YT-69281

YATO	
YT-69287	20/1000

14

Measuring tools Narzędzia miernicze



Electric meters
Mierniki elektryczne

268



Vernier calipers
Suwmiarki

272



Multimeters
Mierniki

269



Micrometers
Mikrometry

273



Measuring tapes
Miary zwijane

270-271



Electronic measuring tools
Elektroniczne urządzenia pomiarowe

273



Rulers
Przymiary

272



Levels
Poziomnice

274



Try squares
Kątowniki stolarskie

272



Feelers
Szczelinomierze

275



GB Digital voltage tester
 D Digitaler-Spannungsprüfer
 PL Wskaźnik elektryczny
 RUS Тестер напряжения цифровой
 CZ Zkoušečka napětí digitální
 H Digitális voltmérő
 RO Tester digital pt. tensiune electrica

F Testeur de tension type tournevis
 I Cerca fase digitale
 E Indicador eléctrico
 CN 数显测电笔

SLIDING CARD



12-250 V
 50-500 Hz
 LCD DISPLAY
 NO BATTERY NEEDED
 NE POTREBUJE BATERII



YATO
 YT-2861 20/500



YATO
 YT-2862 20/500



YATO
 YT-2863 6/120

GB Analogue battery tester
 D Analoges Batterieprüfgerät
 PL Tester akumulatorów analogowy
 RUS Аналоговый тестер аккумуляторов
 CZ Analogový tester akumulátorů
 H Analóg akkuteszter
 RO Tester acumulatori analog
 F Testeur de charge batterie
 I Tester analogico per batteria
 E Tester analógico para acumuladores
 CN 电池测试器

6 V
 12 V
 CCA 200-1000 A

GB Digital battery tester
 D Digitales Batterieprüfgerät
 PL Tester akumulatorów cyfrowy
 RUS Цифровой тестер аккумуляторов
 CZ Digitální tester akumulátorů
 H Digitális akkuteszter
 RO Tester acumulatori digital
 F Testeur digital de charge batterie
 I Tester digitale per batteria
 E Tester digital para acumuladores
 CN 电池测试器

12 V
 LED DISPLAY
 CCA 150-1400 A

GB Battery tester
 D Batterieprüfgerät
 PL Tester akumulatorów
 RUS Тестер аккумуляторов
 CZ Tester akumulátorů
 H Akkuteszter
 RO Tester acumulatori
 F Testeur électronique de charge batterie et alternateur
 I Tester per batteria
 E Tester para acumuladores
 CN 电池测试器

12 V
 BATTERY TEST
 TEST AKUMULATORA
 ALTERNATOR TEST
 TEST ALTERNATORA



YATO
 YT-8310 10



YATO
 YT-8311 10



YATO
 YT-83101 12/72

GB Digital universal multimeter
D Universell digital Messgerät
PL Cyfrowy miernik uniwersalny
RUS Универсальный цифровой измеритель
CZ Digitální multimetr univerzální
H Digitális multiméter

RO Multimetru digital universal
F Multimètre numérique
I Universale tester digitale
E Manómetro digital universal
CN 数字万用表

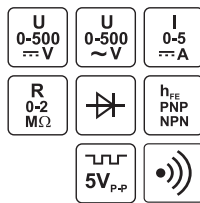

COLOR BOX



COLOR BOX

YATO
YT-73080 50

YATO
YT-73084 44

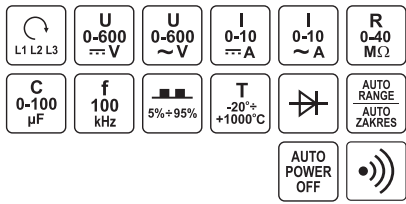

NYLON CASE & COLOR BOX



YATO
YT-73086 24

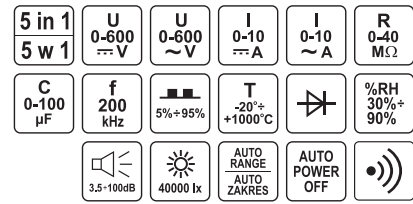

NYLON CASE & COLOR BOX



YATO
YT-73087 24

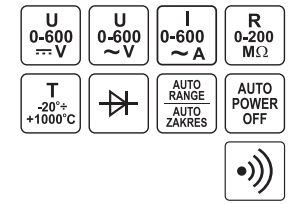

NYLON CASE & COLOR BOX



YATO
YT-73091 20

GB Measuring tape CZ Měřicí pásmo F Ruban à mesurer E Flexómetro
 D Rollbandmass H Mérőszalag I Misura di nastro CN 卷尺
 PL Miara zwijana RO Rulete din pinza
 RUС Рулетка

3m
16mm

5m
19mm

AUTOMATIC
 **GRADE II**

 **MAGNETIC HOOK**

GRADE II

 **NYLON COATED**



3m
16mm

5m
25mm

8m
25mm

SLIDING CARD



AUTOMATIC
 **GRADE II**

 **MAGNETIC HOOK**



GRADE II



 **NYLON COATED**



DOUBLE BLISTER



YATO 	L (m)	size / rozmiar (mm)	
YT-7103	3	16	12/120
YT-7105	5	19	12/120

YATO 	L (m)	size / rozmiar (mm)	
YT-7110	3	16	12/120
YT-7111	5	25	12/120
YT-7112	8	25	6/60

3m
16mm

5m
19mm

8m
25mm

 **MAGNETIC HOOK**

GRADE II

 **NYLON COATED**



3m
16mm

5m
19mm

8m
25mm

DOUBLE BLISTER



 **MAGNETIC HOOK**



GRADE II



 **NYLON COATED**



DOUBLE BLISTER



YATO 	L (m)	size / rozmiar (mm)	
YT-7116	3	16	12/120
YT-7117	5	19	12/120
YT-7118	8	25	6/60

YATO 	L (m)	size / rozmiar (mm)	
YT-7126	3	16	12/120
YT-7127	5	19	12/120
YT-7128	8	25	6/60

3m
16mm

5m
19mm

8m
25mm

 **MAGNETIC HOOK**

GRADE II

 **NYLON COATED**



3m
16mm

5m
19mm

8m
25mm

DOUBLE BLISTER







GRADE II



DISPLAY COLOR BOX



YATO 	L (m)	size / rozmiar (mm)	
YT-7129	3	16	12/120
YT-7130	5	19	12/120
YT-7131	8	25	6/60

YATO 	L (m)	size / rozmiar (mm)		Pcs packing
YT-71130	3	16	12	60/120
YT-71131	5	19	12	48/96
YT-71133	8	25	12	18/36



DOUBLE BLISTER





3m
16mm

5m
19mm

8m
25mm

GRADE II

YATO 	L (m)	size / rozmiar (mm)	
YT-71135	3	16	12/144
YT-71136	5	19	12/72
YT-71138	8	25	8/48

GB Measuring tape
D Rollbandmass
PL Miara zwijana
RUS Рулетка

CZ Měřicí pásmo
H Mérőszalag
RO Ruleta din pinza

F Ruban à mesurer
I Misura di nastro

E Flexómetro
CN 卷尺

8m
25mm

GRADE
II

NYLON
COATED



DISPLAY
COLOR BOX



YATO	L (m)	size / rozmiar (mm)	PCS packing	
YT-71184	8	25	12	24/48

2m
16mm

3m
16mm

5m
19mm

8m
25mm

10m
25mm

GRADE
II

NYLON
COATED



DOUBLE
BLISTER



YATO	L (m)	size / rozmiar (mm)	
YT-71185	2	16	12/144
YT-71186	3	16	12/72
YT-71187	5	19	12/72
YT-71188	8	25	6/36
YT-71189	10	25	6/36

GB Steel measuring tape
D Rollbandmass
PL Taśma miernicza stalowa
RUS Мерная лента стальная
CZ Měřicí pásmo ocelové
H Acél mérőszalag
RO Ruleta sticlă

F Ruban à mesurer acier
I Misura di nastro a acciaio
E Cinta de medir de acero
CN 长钢卷尺

20m
13mm

30m
13mm

50m
13mm

STEEL TAPE
TAŚMA STALOWA

SPEEDY
RETRACTING
SZYBSZE
ZWIJANIE

ABS



PAPER
HANGER



YATO	L (m)	size / rozmiar (mm)	
YT-71560	20	13	5/20
YT-71561	30	13	5/20
YT-71562	50	13	5/20

GB Fibreglass measuring tape
D Rollbandmass
PL Taśma miernicza z włókna szklanego
RUS Мерная лента фибергласс
CZ Měřicí pásmo - skleněné vlákno
H Mérőszalag - üvegszál
RO Ruleta fibra sticlă

F Ruban à mesurer fibre-verre
I Misura di nastro in fibra di vetro
E Cinta de medir - fibra cristal
CN 长纤维卷尺

20m
15mm

30m
15mm

50m
13mm

FIBREGLASS TAPE
TAŚMA Z WŁÓKNA
SZKLANEGO

SPEEDY
RETRACTING
SZYBSZE
ZWIJANIE

ABS



PAPER
HANGER



YATO	L (m)	size / rozmiar (mm)	
YT-71565	20	15	5/20
YT-71566	30	15	5/20
YT-71567	50	15	5/20

GB Steel survey tape
D Rollbandmass
PL Miara geodezyjna stalowa
RUS Мерная лента стальная
CZ Měřicí pásmo ocelové geodetické
H Acél mérőszalag, geodéziai

RO Bandă de măsură pt. geodezie
F Ruban à mesurer acier
I Nastro flessibile
E Cinta de medir de acero
CN 手提架式钢卷尺

30m
13mm

50m
13mm

STEEL TAPE
TAŚMA STALOWA

ABS



COLOR BOX



YATO	L (m)	size / rozmiar (mm)	
YT-71551	30	13	10
YT-71552	50	13	10

GB Fibreglass survey tape
D Rollbandmass
PL Miara geodezyjna z włókna szklanego
RUS Мерная лента фибергласс
CZ Měřicí pásmo - skleněné vlákno

H Mérőszalag - üvegszál
RO Ruleta fibra sticlă
F Ruban à mesurer acier
I Misura di nastro in fibra di vetro
E Cinta de medir - fibra cristal
CN 手提架式纤维卷尺

30m
13mm

50m
13mm

FIBREGLASS TAPE
TAŚMA Z WŁÓKNA
SZKLANEGO

ABS



COLOR BOX





YATO	L (m)	size / rozmiar (mm)	
YT-71555	30	13	10
YT-71556	50	13	10

- GB Aluminium ruler *RUS* Линейка алюминиевая *RO* Riglă tâmplar din aluminiu *E* Regla de aluminiu
D Alu zeichen-massstab *CZ* Měřicí lat' hlinková *F* Règle aluminium *CN* 铝合金直尺
PL Przymiar aluminiowy *H* Aszталos vonalzó, alumínium *I* Righello di alluminio

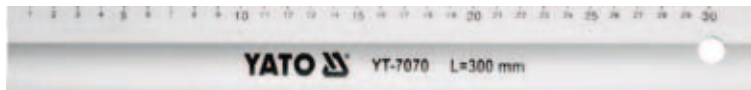

AI



YATO 	L (mm)	
YT-7070	300	25/100
YT-7071	600	10/50

- GB Aluminium try square
D Anschlagwinkel
PL Kałownik aluminiowy
RUS Угольник столярный
CZ Truhlářský úhelník
H Aszталos derékszög
RO Echer de tâmplărie
F Equerre en aluminium
I Angolo di alluminio
E Escuadra de aluminio
CN 铝合金角尺





YATO 	L (mm)	
YT-7080	250	6/36
YT-7081	300	6/36
YT-7082	350	6/36

- GB Try square
D Anschlagwinkel
PL Kałownik stalowy
RUS Угольник столярный
CZ Truhlářský úhelník
H Aszталos derékszög
RO Echer de tâmplărie
F Equerre
I Angolo di acciaio
E Escuadra
CN 不锈钢角尺





STAINLESS
STEEL
STAL
NERDZEWA



YATO 	size / rozmiar (mm)	
YT-7083	150 x 300	25/100
YT-7084	250 x 500	10/50

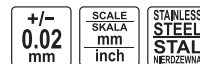
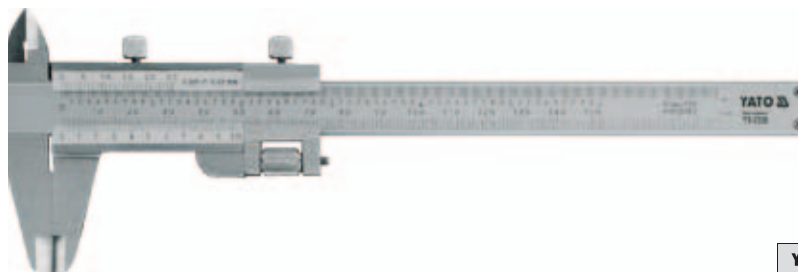

- GB Vernier caliper
D Messschieber
PL Suwmiarka
RUS Штангенциркуль
CZ Posuvné měřtko
H Tolómérő
RO Şubler
F Pied à coulisse
I Calibro
E Calibre
CN 游标卡尺



YATO 	range / zakres (mm)	
YT-7200	0-150	10/50



- GB Digital caliper
D Digital Messschieber
PL Suwmiarka elektroniczna
RUS Штангенциркуль электронный
CZ Posuvné měřtko elektronické
H Elektronikus tolómérő
RO Şubler electronic
F Pied à coulisse électronique
I Calibro
E Calibre electrónico
CN 数显卡尺

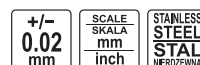

YATO 	range / zakres (mm)	
YT-7201	0-150	10/50

- GB Vernier caliper
D Messschieber
PL Suwmiarka
RUS Штангенциркуль
CZ Posuvné měřtko
H Tolómérő
RO Şubler
F Pied à coulisse
I Calibro
E Calibre
CN 游标卡尺



YATO 	range / zakres (mm)	
YT-72003	0-200	30
YT-72004	0-300	20

GB Micrometer
D Mikrometer
PL Mikrometr
RUS Микрометр

CZ Mikrometr
H Mikrométer
RO Micrometru
F Micromètre

I Micrometro
E Micrómetro
CN 外径千分尺

+/-
0.01
mm



PLASTIC CASE & COLOR BOX

YATO	range / zakres (mm)	
YT-72300	0-25	10/30
YT-72301	25-50	10/30

YATO	range / zakres (mm)	
YT-72302	50-75	10/20
YT-72303	75-100	5/10

GB Micrometer with a digital display
D Mikrometer mit Digitalanzeige
PL Mikrometr z wyświetlaczem cyfrowym
RUS Микрометр с цифровым индикатором
CZ Mikrometr s digitálnim displejem

H Mikrométer digitális kijelzővel
RO Micrometru cu afișaj digital
F Micromètre
I Micrometro con digitale elettronico
E Micrómetro con pantalla digital
CN 杆径数显千分尺

+/-
0.01
mm

SCALE
SKALA
mm
inch

LCD
DISPLAY



PLASTIC CASE & COLOR BOX

YATO	range / zakres (mm)	
YT-72305	0-25	10/20

GB Laser distance meter
D Laserentfernungsmesser
PL Dalmierz laserowy
RUS Лазерный дальномер
CZ Laserový měřič vzdálenosti
H Lézeres távolságmérő
RO Telemetru cu laser
F Télémètre laser
I Telemetro laser
E Medidores láser de distancias
CN 激光测距仪

COLOR
BOX



0.05-30m
+/- 2 mm



20
MEMORY
PAMIEĆ

7
MODES
TRYBÓW



GB Laser distance meter
D Laserentfernungsmesser
PL Dalmierz laserowy
RUS Лазерный дальномер
CZ Laserový měřič vzdálenosti
H Lézeres távolságmérő
RO Telemetru cu laser
F Télémètre laser
I Telemetro laser
E Medidores láser de distancias
CN 激光测距仪

COLOR
BOX



0.05-40m
+/- 2 mm



20
MEMORY
PAMIEĆ

8
MODES
TRYBÓW



GB Stud finder
D Entfernungsmesser
PL Wykrywacz profili i przewodów
RUS Цифровой детектор
CZ Digitální detektor
H Digitális kereső műszer
RO Detector digital
F Détecteur de métaux et de câbles électriques
I Detector digitale
E Escáner de pared
CN 墙体探测仪

HANGING
COLOR
BOX

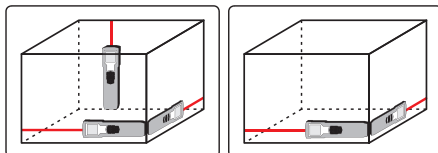
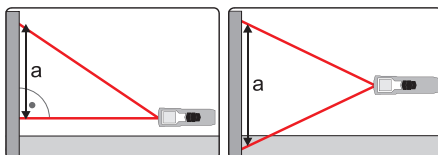

compact
size
kompaktowy
rozmiar

YATO	
YT-73124	40

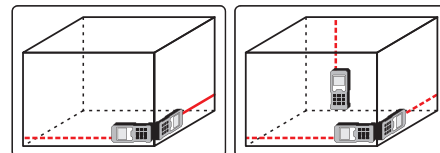
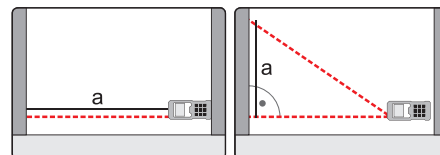

Tripod not included
Státýw nie jest częścią zestawu

YATO	
YT-73125	20

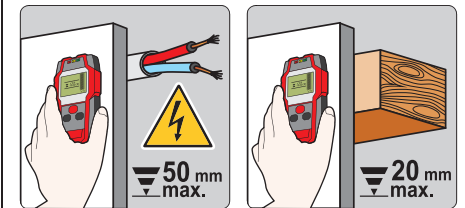
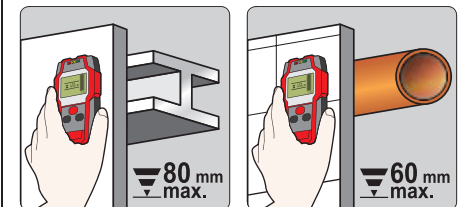

YATO	
YT-73131	40

GB Aluminium level CZ Vodováha I Livella
 D Wasserwaage H Vizmérték E Nivel
 PL Poziomnica aluminiowa RO Cumpănă CN 铝合金水平尺
 РУS Уровень F Niveau à bulle





SHOCK PROOF
ODPORNÁ NA WSTRZĄSY



ACCURACY
DOKŁADNOŚĆ
 0.057°
± 1.0 mm/m

3
PRECISION
VIALS
LIBELLE

1.5mm
ALUMINIUM
HIGH QUALITY PROFILE
ALUMINIOWY
PROFIL WYSOKIEJ JAKOŚCI



YATO 	L (mm)	
YT-3001	400	20/60
YT-3002	600	20/60
YT-3003	800	20/60
YT-3004	1000	20/60
YT-3005	1200	20/60



ACCURACY
DOKŁADNOŚĆ
 0.057°
± 1.0 mm/m

3
PRECISION
VIALS
LIBELLE

1.5mm
ALUMINIUM
HIGH QUALITY PROFILE
ALUMINIOWY
PROFIL WYSOKIEJ JAKOŚCI



YATO 	L (mm)	
YT-3022	600	20/60
YT-3023	800	20/60
YT-3024	1000	30
YT-3025	1200	30
YT-3026	1500	30



ACCURACY
DOKŁADNOŚĆ
 0.027°
± 0.5 mm/m

ALUMINIUM
HIGH QUALITY
PROFILE
ALUMINIOWY
PROFIL WYSOKIEJ
JAKOŚCI

3
PRECISION
VIALS
LIBELLE

YATO 	L (mm)	
YT-30071	600	10/40
YT-30072	800	10/30
YT-30073	1000	10/20
YT-30074	1200	10/20





ACCURACY
DOKŁADNOŚĆ
 0.027°
± 0.5 mm/m

ALUMINIUM
HIGH QUALITY
PROFILE
ALUMINIOWY
PROFIL WYSOKIEJ
JAKOŚCI

2
PRECISION
VIALS
LIBELLE



YATO 	L (mm)	
YT-30061	600	10/40
YT-30062	800	10/30
YT-30063	1000	10/20
YT-30064	1200	10/20

15

Pneumatic tools Narzędzia pneumatyczne



Impact wrenches
Klucze udarowe



278-281

Pneumatic accessories
Akcesoria instalacji pneumatycznej



288-289

Impact wrenches 3/8"

Klucze udarowe 3/8"

278

Air filters, regulators & lubricators

Filtry, reduktory i smarownice

288

Impact wrenches 1/2"

Klucze udarowe 1/2"

278

Spiral hoses

Węże spiralne

288

Impact wrenches 3/4"

Klucze udarowe 3/4"

280

Reinforced hoses

Węże zbrojone

288

Impact wrenches 1"

Klucze udarowe 1"

280

Couplers

Złącza

289

Cordless impact wrenches & accessories
Akumulatorowe klucze udarowe i akcesoria



282

Air grease guns
Smarownice pneumatyczne



290

Impact wrenches 1/2"

Klucze udarowe 1/2"

282

Pneumatic riveters

Nitownice pneumatyczne



290

Accessories

Akcesoria

282

Other air tools

Inne narzędzia pneumatyczne



283-286

Pneumatic stitching & nailing machines
Zszywacze i gwoździarki pneumatyczne



291

Pneumatic ratchets & sets

Grzechotki pneumatyczne i zestawy

283

Pneumatic staplers

Zszywacze pneumatyczne

291

Pneumatic grinders & accessories

Szlifierki pneumatyczne i akcesoria

283

Pneumatic nailers

Gwoździarki pneumatyczne

291

Pneumatic cut-off tools & discs

Przecinarki pneumatyczne i tarcze

285

Pneumatic drills

Wiertarki pneumatyczne

285

Pneumatic hammers

Młotki pneumatyczne

285

Holders for tools

Uchwyty na narzędzia

285

Tire inflating guns & heads

Pistolety do pompowania kół i głowice

286

Painting equipment & accessories

Narzędzia do malowania i akcesoria



286-287

Spray guns

Pistolety lakiernicze

286

Inflating guns

Pistolety do przedmuchiwania

287

Washing guns

Pistolety do ropowania

287

Air sand blasters

Pistolety do piaskowania

287

Work benches

Stojaki lakiernicze

287

- GB Impact wrench
- D Druckluft-Schlagschrauber
- PL Klucz pneumatyczny
- RUS Ударный пневматический гайковерт
- CZ Klúč pneumatický
- H Pneumatikus ütvecsavarozó
- RO Pistol pneumatic
- F Clé à choc pneumatique
- I Chiave ad impulsi pneumatica
- E Llave neumática de percusión
- CN 气动扳手



3/8"	TWIN HAMMER TYPE
10mm	
COMPOSITE BODY KOMPOZITOWA OBLUČKA	
0.63 MPa	142 l/min
400 Nm	10000 min ⁻¹
1/4" 6.3mm	



TWIN HAMMER™
mechanism
ensuring resilience
to damage and
overload

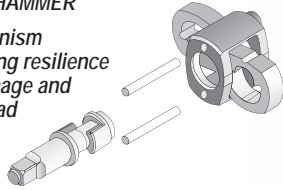

COLOR BOX



YATO	Nm	
YT-09501	400	10

- GB Impact wrench
- D Druckluft-Schlagschrauber
- PL Klucz pneumatyczny
- RUS Ударный пневматический гайковерт
- CZ Klúč pneumatický
- H Pneumatikus ütvecsavarozó
- RO Pistol pneumatic
- F Clé à choc pneumatique
- I Chiave ad impulsi pneumatica
- E Llave neumática de percusión
- CN 气动扳手



1/2"	TWIN HAMMER TYPE
12.5mm	
COMPOSITE BODY KOMPOZITOWA OBLUČKA	
0.62 MPa	120 l/min
540 Nm	7000 min ⁻¹
1/4" 6.3mm	

TWIN HAMMER™
mechanism
ensuring resilience
to damage and
overload

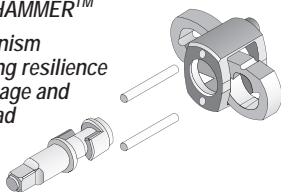

COLOR BOX



YATO	Nm	
YT-0952	540	8

- GB Impact wrench
- D Druckluft-Schlagschrauber
- PL Klucz pneumatyczny
- RUS Ударный пневматический гайковерт
- CZ Klúč pneumatický
- H Pneumatikus ütvecsavarozó
- RO Pistol pneumatic
- F Clé à choc pneumatique
- I Chiave ad impulsi pneumatica
- E Llave neumática de percusión
- CN 气动扳手



1/2"	TWIN HAMMER TYPE
12.5mm	
COMPOSITE BODY KOMPOZITOWA OBLUČKA	
0.63 MPa	119 l/min
550 Nm	7500 min ⁻¹
1/4" 6.3mm	

TWIN HAMMER™
mechanism
ensuring resilience
to damage and
overload

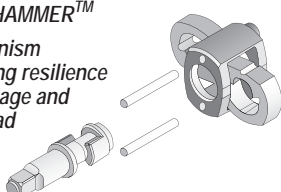

COLOR BOX



YATO	Nm	
YT-09511	550	8

- GB Impact wrench
D Druckluft-Schlagschrauber
PL Klucz pneumatyczny
RUS Ударный пневматический гайковерт
CZ Klíč pneumatický
H Pneumatikus ütvecsavarozó
RO Pistol pneumatic
F Clé à choc pneumatique
I Chiave ad impulsi pneumatica
E Llave neumática de percusión
CN 气动扳手





1/2" 12.5mm	TWIN HAMMER TYPE
0.63 MPa	142 l/min
570 Nm	10000 min ⁻¹
	

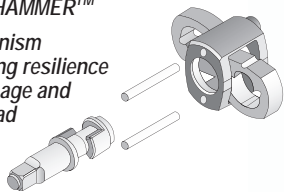

TWIN HAMMER™
mechanism
ensuring resilience
to damage and
overload



YATO 	Nm	
YT-09505	570	10

- GB Impact wrench
D Druckluft-Schlagschrauber
PL Klucz pneumatyczny
RUS Ударный пневматический гайковерт
CZ Klíč pneumatický
H Pneumatikus ütvecsavarozó
RO Pistol pneumatic
F Clé à choc pneumatique
I Chiave ad impulsi pneumatica
E Llave neumática de percusión
CN 气动扳手





1/2" 12.5mm	TWIN HAMMER TYPE
0.63 MPa	153 l/min
1356 Nm	10000 min ⁻¹
	

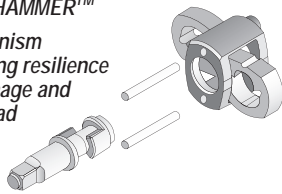

TWIN HAMMER™
mechanism
ensuring resilience
to damage and
overload



YATO 	Nm	
YT-0953	1356	10

- GB Impact wrench
D Druckluft-Schlagschrauber
PL Klucz pneumatyczny
RUS Ударный пневматический гайковерт
CZ Klíč pneumatický
H Pneumatikus ütvecsavarozó
RO Pistol pneumatic
F Clé à choc pneumatique
I Chiave ad impulsi pneumatica
E Llave neumática de percusión
CN 气动扳手





1/2" 12.5mm	TWIN HAMMER TYPE
0.63 MPa	153 l/min
1150 Nm	10000 min ⁻¹
	

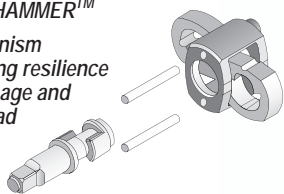

TWIN HAMMER™
mechanism
ensuring resilience
to damage and
overload



YATO 	Nm	
YT-09540	1150	10

- GB Impact wrench
- D Druckluft-Schlagschrauber
- PL Klucz pneumatyczny
- RUS Ударный пневматический гайковерт
- CZ Klúč pneumatický
- H Pneumatikus ütvecsavarzó
- RO Pistol pneumatic
- F Clé à choc pneumatique
- I Chiave ad impulsi pneumatica
- E Llave neumática de percusión
- CN 气动扳手



3/4" 19 mm	TWIN HAMMER TYPE
0.63 MPa	660 l/min
1300 Nm	5000 min ⁻¹
3/8" 10 mm	

TWIN HAMMER™

mechanism ensuring resilience to damage and overload

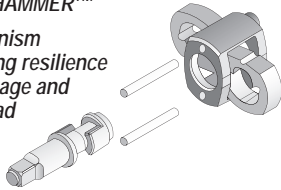

COLOR BOX



YATO	Nm	
YT-09564	1300	6

- GB Impact wrench
- D Druckluft-Schlagschrauber
- PL Klucz pneumatyczny
- RUS Ударный пневматический гайковерт
- CZ Klúč pneumatický
- H Pneumatikus ütvecsavarzó
- RO Pistol pneumatic
- F Clé à choc pneumatique
- I Chiave ad impulsi pneumatica
- E Llave neumática de percusión
- CN 气动扳手



3/4" 19 mm	TWIN HAMMER TYPE
0.63 MPa	198 l/min
1630 Nm	5500 min ⁻¹
3/8" 10 mm	



COMPOSITE BODY
KOMPÓZITÓVA OBÚDOWA

COLOR BOX



YATO	Nm	
YT-09571	1630	6

15



TWIN HAMMER™

mechanism ensuring resilience to damage and overload

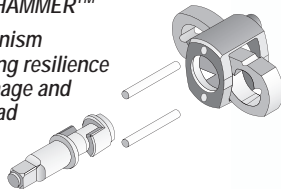

- GB Pneumatic wrench
- D Druckluft-Schlüssel
- PL Klucz pneumatyczny
- RUS Пневматический ключ
- CZ Pneumatický utahovák
- H Pneumatikus kulcs
- RO Cheie pneumatica
- F Clé à choc pneumatique
- I Chiave ad impulsi pneumatica
- E Llave neumática
- CN 气动扳手



1" 25 mm	PINLESS HAMMER TYPE	0.63 MPa	560 l/min
2600 Nm	4000 min ⁻¹	1/2" 12.5 mm	

PINLESS HAMMER™

closed hammer cage mechanism prevents breakage from hammer pin damage

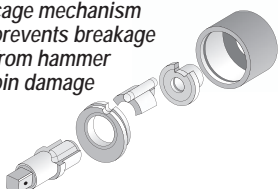

- application: automotive service stations, trucks
- przeznaczenie: serwis, samochody ciężarowe
- strong, uniform impact
- silny, jednolity uder

BMC & COLOR SLEEVE



YATO	Nm	
YT-0959	2600	2

GB Pneumatic wrench
D Druckluft-Schlüssel
PL Klucz pneumatyczny
RUS Пневматический ключ
CZ Pneumatický utahovák
H Pneumatikus kulcs

RO Cheie pneumatica
F Clé à choc pneumatique
I Chiave ad impulsi pneumatica
E Llave neumática
CN 气动扳手

1" 25mm	PINLESS HAMMER TYPE	0.63 MPa	560 l/min
2600 Nm	4000 min ⁻¹	1/2" 12.5mm	



PINLESS HAMMER™

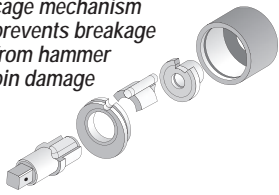

closed hammer
cage mechanism
prevents breakage
from hammer
pin damage



- application: automotive service stations, trucks
- przeznaczenie: serwis, samochody ciężarowe
- strong, uniform impact
- silny, jednolity uder

BMC
& COLOR
SLEEVE



YATO 	Nm	
YT-0960	2600	2

GB Pneumatic wrench
D Druckluft-Schlüssel
PL Klucz pneumatyczny
RUS Пневматический ключ
CZ Pneumatický utahovák
H Pneumatikus kulcs
RO Cheie pneumatica
F Clé à choc pneumatique
I Chiave ad impulsi pneumatica
E Llave neumática
CN 气动扳手

1" 25mm	TWIN HAMMER TYPE	0.63 MPa	255 l/min
8.3 kg ULTRA LIGHT	2700 Nm	4800 min ⁻¹	
1/4" 6.3mm	1/2" 12.5mm		

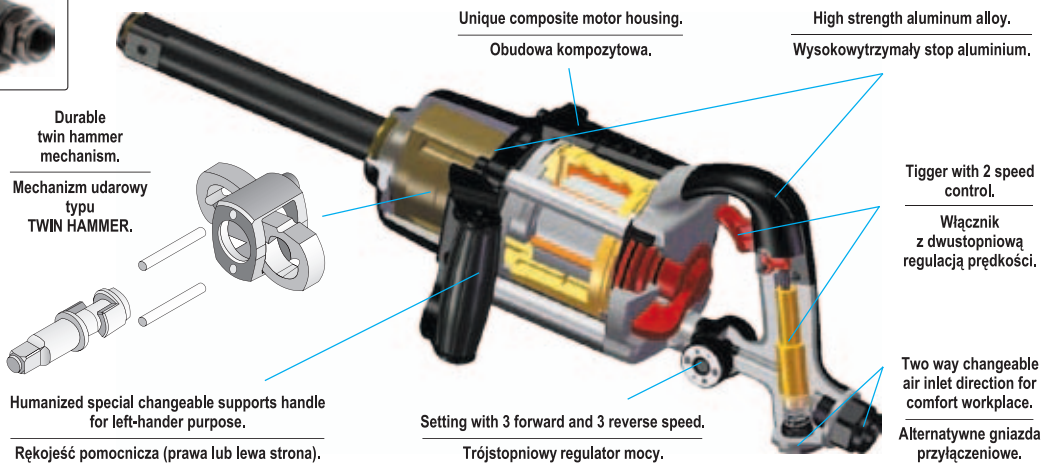

COMPOSITE
BODY
KOMPOZYTOWA
OBUDOWA



- application: industry, service stations, tire service stations, truck service
- the lightest 1" impact wrench with torque of 2700 Nm
- magnesium alloy and composite housing
- low vibration
- low air consumption
- przeznaczenie: przemysł, serwisy mobilne i stacjonarne, serwisy opon oraz pojazdów ciężarowych
- najlżejszy klucz pneumatyczny w klasie 1" o mocy 2700 Nm
- obudowa ze stopów magnezu i kompozytu
- niski poziom wibracji
- małe zużycie powietrza

COLOR BOX



YATO 	Nm	
YT-09611	2700	2

GB Cordless impact wrench
 D Akku-schlagschrauber
 PL Akumulatorowy klucz udarowy
 RUS Аккумуляторный ударный гайковерт
 CZ Akumulátorový rázový utahovák
 H Aakkus ütvecsavarozó
 RO Pistol impact cu acumulator
 F Clé a choc sans fil
 I Chiave ad impulsi con chiavi a bussola esagonale
 E Inalámbrico llave de impacto
 CN 气动棘轮扳手

1/2" 12.5mm	280 Nm	18 V	0-2200 min	T 0-3300 mm
Li-Ion	3000 mAh	2h QUICK CHARGING SZYBKE ŁADOWANIE	LED BATTERY INDICATOR WYŚWIETLANIE WYPOSAŻENIA AKUMULATORA	17,19 21,22 mm
↻				

GB Cordless impact wrench
 D Akku-schlagschrauber
 PL Akumulatorowy klucz udarowy
 RUS Аккумуляторный ударный гайковерт
 CZ Akumulátorový rázový utahovák
 H Aakkus ütvecsavarozó
 RO Pistol impact cu acumulator
 F Clé a choc sans fil
 I Chiave ad impulsi con chiavi a bussola esagonale
 E Inalámbrico llave de impacto
 CN 气动棘轮扳手

1/2" 12.5mm	280 Nm	18 V	0-2200 min	T 0-3300 mm
Li-Ion	3000 mAh	2h QUICK CHARGING SZYBKE ŁADOWANIE	LED BATTERY INDICATOR WYŚWIETLANIE WYPOSAŻENIA AKUMULATORA	17,19 21,22 mm
↻				

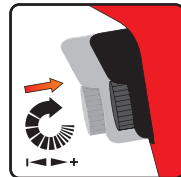

YATO	Nm	Box
YT-82930	280	3



YATO	Nm	Box
YT-82931	280	3

GB Battery
 D Akkumulator
 PL Akumulator
 RUS Аккумулятор
 CZ Akumulátor
 H Akumulátor
 RO Acumulatorul
 F Batterie
 I Batteria
 E Bateria
 CN 锂电池



WHITE CARTON BOX & COLOR LABEL



18 V	Li-Ion	3000 mAh	2h QUICK CHARGING SZYBKE ŁADOWANIE
---------	--------	-------------	--

for / dla: YT-82930, YT-82931

YATO	V	Box
YT-82932	18	20



- GB Ratchet air wrench
D Druckluft-Ratschenschrauber
PL Grzechotka pneumatyczna
RUS Пневмотрещотка
CZ Utahovák vzduchový
H Préslevegős beható szerszám
RO Antrenor pneumatic
F Clé à cliquet pneumatique
I Chiave a cricchetto pneumatica
E Carraca neumática
CN 气动棘轮扳手



COLOR BOX



1/2" 12.5mm	0.62 MPa	120 l/min
80 Nm	160 min ⁻¹	1/4" 6.3mm

YATO 	Nm	
YT-0981	80	20



- GB Ratchet air wrench
D Druckluft-Ratschenschrauber
PL Grzechotka pneumatyczna
RUS Пневмотрещотка
CZ Utahovák vzduchový
H Préslevegős beható szerszám
RO Antrenor pneumatic
F Clé à cliquet pneumatique
I Chiave a cricchetto pneumatica
E Carraca neumática
CN 气动棘轮扳手



COLOR BOX











1/2" 12.5mm	0.62 MPa	110 l/min
68 Nm	160 min ⁻¹	1/4" 6.3mm



YATO 	Nm	
YT-0980	68	20

- GB Ratchet wrench kit
D Druckluft-Ratschenschrauber mit Zubehör
PL Zestaw z grzechotką pneumatyczną
RUS Пневмотрещотка в наборе
CZ Klíč ráčnový pneumatický s příslušenstvím
H Pneumatikus racsnikulcs készlet
RO Cheie pneumatica cu accesorii
F Clé à cliquet pneumatique
I Chiave a cricchetto pneumatica
E Juego con carraca neumática
CN 气动棘轮扳手组套



-  1/2" (12.7 mm), L=75 mm;
 6 mm x 1/2" (12.7 mm);
 1/2" (12.7 mm);
 H4, H5, H6, H7, H8;
 T20, T25, T27, T30, T40;
 5.5, 6.5, 8.0 mm;
 PH2, PH3, PH4;
 10, 11, 12, 13, 14, 17, 19 mm

1/2" 12.5mm	OILER POT
0.62 MPa	110 l/min
68 Nm	160 min ⁻¹
1/4" 6.3mm	CrV

YATO 	Nm	
YT-0982	68	4

BMC & COLOR SLEEVE



- GB Air grinder
D Drucklufterhandschleifer
PL Szlifierka pneumatyczna prosta
RUS Шлифмашинка пневматическая
CZ Bruska přímá pneumatická
H Préslevegős sarokcsiszoló
RO Polizor pneumatic
F Mini ponçeuse pneumatique
I Smerigliatrice dritta pneumatica
E Lijadora neumática recta
CN 气动修磨机



COLOR BOX



0.62 MPa	160 l/min
20000 min ⁻¹	Ø 3 6mm
	1/4" 6.3mm

YATO 	
YT-0965	25

GB Air sander
 D Druckluft-Excenterschleifer
 PL Szlifierka pneumatyczna mimośrodowa
 RUS Шлифмашина эксцентриковая пневматическая
 CZ Bruska pneumatická
 H Pneumatikus sarokcsiszológép
 RO Masina de slefuit pneumatica
 F Ponceuse pneumatique
 I Smerigliatrice orbitale pneumatica
 E Lijadora neumática excéntrica
 CN 气动砂磨机

0.63 MPa
 84 l/min
 10500 min⁻¹
 150 mm
 1/4"
 6.3mm
 VACUUM SYSTEM
 SYSTEM ODPYLANIA
 ECCENTRIC



YATO YT-09740 10

GB Air sander
 D Druckluft-Excenterschleifer
 PL Szlifierka pneumatyczna mimośrodowa
 RUS Шлифмашина эксцентриковая пневматическая
 CZ Bruska pneumatická
 H Pneumatikus sarokcsiszológép
 RO Masina de slefuit pneumatica
 F Ponceuse pneumatique
 I Smerigliatrice orbitale pneumatica
 E Lijadora neumática excéntrica
 CN 气动砂磨机

0.62 MPa
 230 l/min
 9000 min⁻¹
 150 mm
 1/4"
 6.3mm
 ECCENTRIC



YATO YT-0967 10

GB Air belt sander
 D Pneumatische Bandschleifer
 PL Pneumatyczna szlifierka taśmowa
 RUS Пневматический шлифовальный
 CZ Pneumatická pásová bruska
 H Pneumatikus szalagcsiszoló
 RO Polizor pneumatic cu banda
 F Ponceuse à bandes pneumatique
 I Nastro per levigatrice pneumatica
 E Lijadora de banda neumática
 CN 气动砂带机



170 l/min
 0.63 MPa
 20000 min⁻¹
 EASY BELT REPLACEMENT
 LATWA WYMIANA PASA
 1/4"
 6.3mm



COLOR BOX

includes belts: /
 w zestawie pasy:
 P60, P80, P120

YATO belt size / rozmiar pasa (mm) 10

GB Air belt sander
 D Pneumatische Bandschleifer
 PL Pneumatyczna szlifierka taśmowa
 RUS Пневматический шлифовальный
 CZ Pneumatická pásová bruska
 H Pneumatikus szalagcsiszoló
 RO Polizor pneumatic cu banda
 F Ponceuse à bandes pneumatique
 I Nastro per levigatrice pneumatica
 E Lijadora de banda neumática
 CN 气动砂带机



200 l/min
 0.63 MPa
 20000 min⁻¹
 EASY BELT REPLACEMENT
 LATWA WYMIANA PASA
 1/4"
 6.3mm



COLOR BOX

includes belts: /
 w zestawie pasy:
 P60, P80, P120

YATO belt size / rozmiar pasa (mm) 10

GB Endless sanding belt
 D Schleifband
 PL Taśma ścierna bezkońcowa
 RUS Шлифовальные ленты
 CZ Brusný pás
 H Csiszoló szalag
 RO Bandă de pânză
 F Bande abrasive sans fin
 I Nastro abrasivo senza fine

- application: metal, wood
- abrasive: aluminium oxide
- bond: synthetic resin
- coating: close
- zastosowanie: metal, drewno
- ścierniwo: tlenek glinu
- spoiwo: żywica syntetyczna
- nasyp pełny



E Pano abrasivo cinturón
 CN 砂带

HANGING
 COLOR BOX

- application: metal, wood
- abrasive: aluminium oxide
- bond: synthetic resin
- coating: close
- zastosowanie: metal, drewno
- ścierniwo: tlenek glinu
- spoiwo: żywica syntetyczna
- nasyp pełny



YATO	grit / ziarnistość	size / rozmiar (mm)	PCS packing	
YT-09743	60	10x330	10	100
YT-09744	80	10x330	10	100
YT-09745	100	10x330	10	100
YT-09746	120	10x330	10	100

YATO	grit / ziarnistość	size / rozmiar (mm)	PCS packing	
YT-09747	60	20x520	10	50
YT-09748	80	20x520	10	50
YT-09749	100	20x520	10	50
YT-09750	120	20x520	10	50

GB Air cut-off tool
D Druckluft-Schneidmaschine
PL Przecinarka pneumatyczna
RUS Резак пневматический
CZ Příčná bruska pneumatická
H Pneumatikus sarokcsiszoló

RO Masina de taiat
cu aer comprimat
F Coupeuse pneumatique
I Fresa pneumática
E Cortadora neumática
CN 气动切割工具

0.62 MPa
480 l/min
18000 min⁻¹
1/4"
6.3mm



COLOR BOX

YATO
YT-0993 20

GB Metal cutting disc
D Metall-Trennscheibe
PL Tarcza do cięcia metalu
RUS Круги отрезные по металлу
CZ Souprava kotoučů pro řezání kovů
H Vágókorong fémhez
RO Set de pânze de tăiat metal
F Set de disques
I Disco per taglio metallo
E Disco cortador para metal
CN 金属切割片组套

for / dla: YT-0993

5 PCS
75 mm
2 mm
9.5 mm
18000 min⁻¹



BLISTER CARD

YATO
YT-0994 12/48

GB Reversible air drill
D Druckluft-Bohrmaschine
mit Stahl-Zahnkranzfutter
PL Wiertarka pneumatyczna
RUS Пневматическая дрель
CZ Vrtačka ruční vzduchová
H Préslevegős fúrógép

RO Masina de gaurit
pneumatica mandrina
F Perceuse pneumatique
I Fresa pneumática
E Taladradora neumática
CN 双向气钻

0.62 MPa
113 l/min
0-1800 min⁻¹
max. **10 mm**
1/4"
6.3mm



COLOR BOX

YATO
YT-0970 20

GB Reversible air drill
D Druckluft-Bohrmaschine
mit Stahl-Zahnkranzfutter
PL Wiertarka pneumatyczna
RUS Пневматическая дрель
CZ Vrtačka ruční vzduchová
H Préslevegős fúrógép

RO Masina de gaurit
pneumatica mandrina
F Perceuse pneumatique
I Fresa pneumática
E Taladradora neumática
CN 双向气钻

1.7 kg
0.63 MPa
198 l/min
700 min⁻¹
max. **10 mm**
1/4"
6.3mm



COLOR BOX

YATO
YT-09702 12

GB Air hammer
D Druckluft-Schlaghammer
PL Młotek pneumatyczny
RUS Зубило пневматическое
CZ Sekáč vzduchový
H Pneumatikus vésőkészlet
pisztolyal

RO Ciosan cu aer comprimat
F Maretou pneumatique
I Martello pneumática
E Martillo neumático
CN 气锤

0.62 MPa
113 l/min
3200 min⁻¹
1/4"
6.3mm



COLOR BOX

YATO
YT-0990 10

GB Magnetic holder for tools
D Magnethalter für Schlagschrauber
PL Uchwyt magnetyczny na narzędzia
RUS Магнитный держатель
для ударного гайковерта
CZ Magnetický držák nářadí
H Magneses befogó
RO Suport magnetic pt. scule pneumatice
F Support magnétique
pour outils pneumatiques
I Fissaggio magnetico per chiave ad
impulsi pneumatica
E Soporte magnético para llave de impacto
CN 磁性喷枪架

15 kg max.
MAGNETIC



COLOR BOX

YATO
YT-08707 5/10

GB Tire-inflating gun
 D Reifenfüller
 PL Pistolet do pompowania kół
 RUS Пистолет для накачивания колёс
 CZ Pistole na čerpání z manometrem
 H Gumiabroncs pumpáló
 RO Pistol cu manometru pt. pompat

F Pistolet pour gonflage de pneus avec manomètre
 I Pistola per gonfiaggio gomme
 E Pistola de bombeo con manometro
 CN 轮胎气压表

0.6 MPa (max)
 440mm HOSE WAZ
 360°
 1/4" 6.3mm



YATO
 YT-2370 20



GB Tire-inflating gun
 D Reifenfüller
 PL Pistolet do pompowania kół
 RUS Пистолет для накачивания колёс
 CZ Pistole na čerpání z manometrem
 H Gumiabroncs pumpáló
 RO Pistol cu manometru pt. pompat
 F Pistolet pour gonflage de pneus avec manomètre
 I Pistola per gonfiaggio gomme

E Pistola de bombeo con manometro
 CN 轮胎气压表

0.8 MPa (max)
 440mm HOSE WAZ
 AI
 1/4" 6.3mm



YATO
 YT-2370 8/40



GB Inflating head
 D Klemmnippel (universal)
 PL Głowica do pompowania
 RUS Универсальная головка
 CZ Hlava na čerpání
 H Pumpafej
 RO Cap pt. pompat
 F Mandrin de pompe
 I Testa per il pompaggio
 E Cabeza de bombeo
 CN 充气头



YATO	Ø (mm)	
YT-2371	6	50/300
YT-2372	8	50/300



1.0 MPa (max.)

GB Spray gun with fluid cup
 D Lackierpistole mit Fließbecher
 PL Pistolet natryskowy
 RUS Пистолет - распылитель с верхним бачком

CZ Pistole na lakování z nádrží
 H Festőpisztoly alsó tartállyal
 RO Pistol de vopsit cu rezervor inferior
 F Pistolet à peinture
 I Pistola vernice

E Pistola de barniz
 CN 喷枪



Ø 1.4 mm
 410 l/min
 0.30 MPa
 0.6l
 HVLP

Ø 1.5 mm
 410 l/min
 0.30 MPa
 0.6l
 HVLP

Ø 1.8 mm
 380 l/min
 0.40 MPa
 1.0l

Ø 0.8 mm
 220 l/min
 0.30 MPa
 0.1l
 HVLP

YATO
 YT-2340 20

YATO
 YT-2341 20

YATO
 YT-2346 10

YATO
 YT-2357 20

- GB Inflating gun with extension
D Gebläsepistole mit Verlängerung
PL Pistolet do przedmuchiwania z przedłużką
RUS Пистолет для продувки с удлинителем
CZ Pistole na profukování dlouhá
H Rövid előléfűvő pisztoly
RO Pistol lung pt. suflat
F Pistolet pour purger
I Pistola professionale
E Pistola de soplado
CN 长杆充气枪

1/4"
6.3mm 0.8 MPa (max.) AI



SLIDING CARD



YATO  
YT-2373 20/40

- GB Washing gun
D Waschpistole
PL Pistolet do gorowania
RUS Пистолет для нефтewания
CZ Pistole na ropování + nádrž
H Olajpízisztoly + tartály

- RO Pistol (dozator) cu rezervor pt. motorină
F Pistolet à l'huile
I Pistola di lavaggio con nafta
E Pistola de petrolear
CN 喷水枪

0.85l 130 l/min AI 0.80 MPa



COLOR BOX



YATO  
YT-2374 2/12

- GB Air sand blaster
D Pistole zum Sandstrahlen
PL Pistolet do piaskowania z wężem
RUS Пескоструйный пистолет
CZ Pískovací pistole s hadicí
H Homokszóró pisztoly tömlővel

- RO Pistol de sablat
F Pistolet de sablage avec tuyau
I Pistola sabbiatrica
E Pistola para limpeza con chorro de arena con manguera
CN 吹气枪

1/4"
6.3mm 6.3mm 1m HOSE WAZ AI

160 l/min 0.80 MPa



SLIDING CARD



YATO  
YT-2375 10

- GB Gun suitable for sand-blasting
D Sandstrahlpistole
PL Pistolet do piaskowania ze zbiornikiem
RUS Пескоструйный пистолет
CZ Pískovací pistole se zásobníkem
H Homokszóró pisztoly tartállyal
RO Pistol de sablat

- F Pistolet de sablage avec réservoir
I Pistola sabbiatrica con serbatoio
E Pistola para limpeza con chorro de arena con recip
CN 喷枪

1.0l 160 l/min AI 0.80 MPa



COLOR BOX



YATO  
YT-2376 20

- GB Work bench
D Lackierständer, verstellbar
PL Stojak lakierniczy rozstawny
RUS Раздвижная лакировочная стойка
CZ Stojan lakýrnický rozkládací
H Kinyitható lakkozó állvány
RO Suport extensibil pt. lacuit
F Support à peindre
I Supporto pieghevole
E Montante plegable para barnizar
CN 工作台



10 kg max 50 cm 85 cm

150 kg max 100 cm 45 cm



COLOR BOX

YATO  
YT-5555 1

- GB Mini filter
D Filter
PL Filtr
RUS Минифильтр
CZ Filtr
H Szűrő
- RO Minifiltru
F Vidange mini
I Filtro
E Filto
CN 微型过滤器

1.4 MPa (max.)

8 cm³

1/4" 6.3mm



YATO
YT-2380 25/50

COLOR BOX



- GB Pressure reducing valve with manometer
D Druckminderer mit Manometer
PL Reduktor ciśnienia z manometrem
RUS Клапан уменьшения давления с манометром
CZ Redukční ventil s manometrem
H Nyomáscsökkentő szelep nyomásmérővel
RO Valva cu reductiepresiune + manometru
F Réducteur avec manomètre
I Regolatore di pressione con manometro
E Reductor + manometro
CN 带表调压减压阀

1.2 MPa (max.)

1/4" 6.3mm



YATO
YT-2381 25/50

COLOR BOX



- GB Filter - reductor
D Druckfilter - Druckminderer
PL Filtr - reduktor
RUS Фильтр - редуктор
CZ Filtr derukční ventil
H Szűrő - nyomásszabályzó
RO Filtru cu reductor
F Réducteur avec filtre et manomètre
I Filtro regolatore
E Reductor + filtro
CN 过滤器

0.93 MPa (max.)

15 cm³

60°C max.

1/4" 6.3mm



YATO
YT-2382 25/50

COLOR BOX



- GB Filter - reductor
D Druckfilter - Druckminderer
PL Filtr - reduktor
RUS Фильтр - редуктор
CZ Filtr derukční ventil
H Szűrő - nyomásszabályzó
RO Filtru cu reductor
F Réducteur avec filtre et manomètre
I Filtro regolatore
E Reductor + filtro
CN 过滤器

0.93 MPa (max.)

90 cm³

60°C max.

1/2" 12.5mm



YATO
YT-2383 25/50

COLOR BOX



- GB Air filter regulator and lubricator
D Druckfilter - Druckminderer + Entöler
PL Zespół filtrujący reduktor + smarownica
RUS Фильтр-редуктор
CZ Redukční ventil s odlučovačem oleje
H Levegőelőkészítő
RO Filtru cu reductor
F Filtre régulateur lubrificateur pour air comprimé
I Filtro regolatore lubrificatore
E Juego de filtro reductor + engrasador
CN 气动三联件

0.93 MPa (max.)

25 cm³ FILTER

15 cm³ LUBRICANT CUP SMAROWNICA

60°C max.

1/4" 6.3mm



YATO
YT-2384 25/50

COLOR BOX



- GB Air filter regulator and lubricator
D Druckfilter - Druckminderer + Entöler
PL Zespół filtrujący reduktor + smarownica
RUS Фильтр-редуктор
CZ Redukční ventil s odlučovačem oleje
H Levegőelőkészítő
RO Filtru cu reductor
F Filtre régulateur lubrificateur pour air comprimé
I Filtro regolatore lubrificatore
E Juego de filtro reductor + engrasador
CN 气动三联件

0.93 MPa (max.)

90 cm³ FILTER

60 cm³ LUBRICANT CUP SMAROWNICA

60°C max.

1/4" 6.3mm



YATO
YT-2385 25

COLOR BOX



- GB Spiral tube with quick coupling
D Spiralschlauch mit Schnellkupplung
PL Waż spiralny z szybkozłączem
RUS Шланг спиральный с быстрым соединением
CZ Spirálová vzduchová hadice
H Levegős spirál tömlő gyorscsatlakozóval
RO Tub spiralat cu cuplare rapida
F Tuyau spirale en polyurethane
I Tubo a spirale con rapido
E Manguera espiral
CN PU气管

PU 1.2 MPa (max.) STANDARD



YATO	Ø (mm)	L (mm)	
YT-24201	5.5x8	5	50
YT-24202	5.5x8	10	25
YT-24203	5.5x8	15	25
YT-24204	6.5x10	5	50
YT-24205	6.5x10	10	25
YT-24206	6.5x10	15	25
YT-24207	8x12	5	50
YT-24208	8x12	10	25
YT-24209	8x12	15	20

- GB Air hose with quick coupler
D Luftschauch mit Schnellkupplung
PL Waż techniczny zbrojony z szybkozłączami
RUS Шланг пневматический с быстроразъемным соединением
CZ Hadice vzduchová s rychlospojками
H Levego tomlok a férfi csatlakozóval
RO Furtun aer comprimat cuple rapide
F Le tuyau d'air avec raccords rapides
I Rinforzato tecnico tubo flessibile con rapido
E Manguera de aire del con los acopladores rápidos
CN PVC气管

PVC 2.0 MPa (max) STANDARD



YATO	Ø (mm)	L (mm)	
YT-24220	8	10	10
YT-24221	8	20	8
YT-24224	10	10	10
YT-24225	10	20	8

GB Quick coupler
D Schnellkupplung
PL Szybkozłącze
RUS Быстрое соединение

CZ Rychlospojka
H Gyorscsatlakozó
RO Mufa rapida pt. pistol pneumatic
F Raccord rapide

I Attacco rapido
E Conexión de la entrada de aire
CN 快速接头

SLIDING CARD

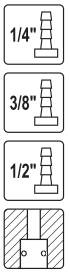
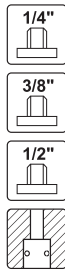

YATO	size / rozmiar	
YT-2390	1/4" (6.3 mm)	50/250
YT-2391	3/8" (10.0 mm)	50/250
YT-2392	1/2" (12.5 mm)	50/250

YATO	size / rozmiar	
YT-2393	1/4" (6.3 mm)	50/250
YT-2394	3/8" (10.0 mm)	50/250
YT-2395	1/2" (12.5 mm)	50/250

YATO	size / rozmiar	
YT-2396	1/4" (6.3 mm)	50/250
YT-2397	3/8" (10.0 mm)	50/250
YT-2398	1/2" (12.5 mm)	50/250

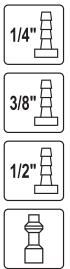
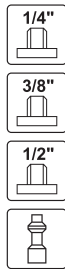

YATO	size / rozmiar	
YT-2399	1/4" (6.3 mm)	50/250
YT-2401	3/8" (10.0 mm)	50/250
YT-2402	1/2" (12.5 mm)	50/250

YATO	size / rozmiar	
YT-2403	1/4" (6.3 mm)	50/250
YT-2404	3/8" (10.0 mm)	50/250

YATO	size / rozmiar	
YT-2405	1/4" (6.3 mm)	50/250
YT-2406	3/8" (10.0 mm)	50/250
YT-2407	1/2" (12.5 mm)	50/250

GB 2 way quick coupler
D Zwei-wege schnellkupplung
PL Szybkozłącze podwójne
RUS Двусторонняя быстроразъемные соединения
CZ Two-way rychlospojky
H Levegőelosztó kettes gyorscsatlakozó
RO Distribuitoare cuple rapide
F Dérivation type y en cuivre
I Raccordo ottone con vie
E Manera 2 manguera de aire pase de acoplamiento rápido
CN 三通万用插嘴

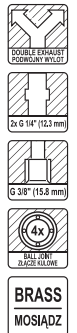

SLIDING CARD

YATO	
YT-24091	25/50

GB Quick coupler
D Schnellkupplung
PL Szybkozłącze
RUS Быстрое соединение
CZ Rychlospojka
H Gyorscsatlakozó
RO Mufa rapida pt. pistol pneumatic
F Raccord rapide
I Attacco rapido
E Conexión de la entrada de aire
CN 快速接头

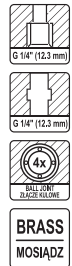

SLIDING CARD

YATO	
YT-24092	50/100

GB Quick coupler
D Schnellkupplung
PL Szybkozłącze
RUS Быстрое соединение
CZ Rychlospojka
H Gyorscsatlakozó
RO Mufa rapida pt. pistol pneumatic
F Raccord rapide
I Attacco rapido
E Conexión de la entrada de aire
CN 快速接头

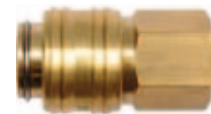
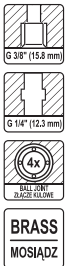

SLIDING CARD

YATO	
YT-24093	50/100

GB Quick coupler
D Schnellkupplung
PL Szybkozłącze
RUS Быстрое соединение
CZ Rychlospojka
H Gyorscsatlakozó

RO Mufa rapida pt. pistol pneumatic
F Raccord rapide
I Attacco rapido
E Conexión de la entrada de aire
CN 快速接头



SLIDING CARD

YATO	
YT-24094	50/100

GB Quick coupler
D Schnellkupplung
PL Szybkozłącze
RUS Быстрое соединение
CZ Rychlospojka
H Gyorscsatlakozó

RO Mufa rapida pt. pistol pneumatic
F Raccord rapide
I Attacco rapido
E Conexión de la entrada de aire
CN 快速接头



SLIDING CARD

YATO	
YT-24095	50/100

- | | |
|--|-------------------------------------|
| GB Air grease gun | F Pistolet de graissage pneumatique |
| D Druckluft-Fettpresse | I Pneumatica per ingrassaggio |
| PL Smarownica pneumatyczna | E Pistola engrasadora neumática |
| RUS Шприц для нагнетания
густой смазки пневматический | CN 气动黄油枪 |
| CZ Mazací lis pneumatický | |
| H Pneumatikus zsírzó | |
| RO Pistol pt. grasat pneumatic | |

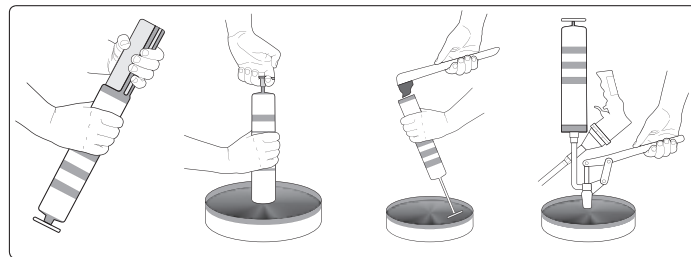

YATO	
YT-07055	10

- | | |
|--------------------------------|-------------------------------|
| GB Pneumatic riveting machine | RO Presa pneumatica de nituri |
| D Pneumatische Nietvorrichtung | F Riveuse pneumatique |
| PL Nitownica pneumatyczna | I Rivettatrice pneumatica |
| RUS Пневматический заклепочник | E Máquina remachadora |
| CZ Pneumatická nýtovačka | CN 气动拉铆枪 |
| H Pneumatikus popszegecszűző | |

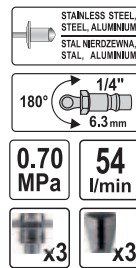

- | | |
|--------------------------------|-------------------------------|
| GB Pneumatic riveting machine | RO Presa pneumatica de nituri |
| D Pneumatische Nietvorrichtung | F Riveuse pneumatique |
| PL Nitownica pneumatyczna | I Rivettatrice pneumatica |
| RUS Пневматический заклепочник | E Máquina remachadora |
| CZ Pneumatická nýtovačka | CN 气动拉铆枪 |
| H Pneumatikus popszegecszűző | |

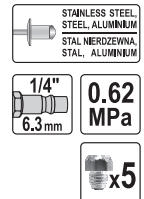

15



- application: industry
- przeznaczenie: przemysł

YATO	Ø (mm)	L (mm)	F (kg)	F (N)	
YT-36171	2.4; 3.2; 4.0; 4.8; 5.0	18	1060	10400	10

YATO	Ø (mm)	L (mm)	F (kg)	F (N)	
YT-3618	2.4; 3.2; 4.0; 4.8; 6.4	16	1389	13620	6

GB Pneumatic stitching machine
D Drucklufthefter
PL Zszywacz pneumatyczny
RUS Пневматический шиватель
CZ Pneumatická sešivačka
H Pneumatikus tűzőgép

RO Capsator pneumatic
F Agrafeuse pneumatique
I Cucitrice pneumatica
E Engrapadora pneumatica
CN 气动码钉枪

7
bar

8-25
mm

1/4"
6.3mm

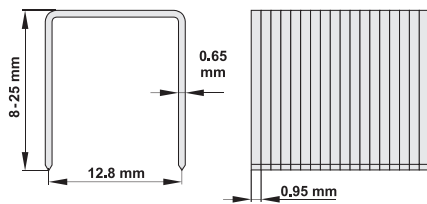

BMC & COLOR SLEEVE 

- application: industry, construction
- przeznaczenie: przemysł, budownictwo

YATO 
YT-0920  5

GB Pneumatic nailing machine
D Druckluftnagelgerät
PL Gwoździarka pneumatyczna
RUS Пневматическая гвоздильная машина
CZ Pneumatický nastřelovač hřebíků
H Pneumatikus szögbelevő
RO Capsator pneumatic

F Cloueur pneumatique
I Chiodatrice pneumatica
E Maquina pneumatica para clavar clavos
CN 气动码钉枪

8
bar

25-64
mm

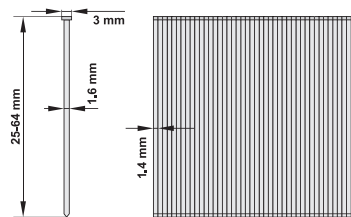

90°

1/4"
6.3mm



BMC & COLOR SLEEVE 

- application: industry, construction
- przeznaczenie: przemysł, budownictwo

YATO 
YT-0921  5

GB Pneumatic nailing machine
D Druckluftnagelgerät
PL Gwoździarka pneumatyczna
RUS Пневматическая гвоздильная машина
CZ Pneumatický nastřelovač hřebíků
H Pneumatikus szögbelevő
RO Capsator pneumatic
F Cloueur pneumatique
I Chiodatrice pneumatica
E Maquina pneumatica para clavar clavos
CN 气动码钉枪

8
bar

50-90
mm

34°

1/4"
6.3mm

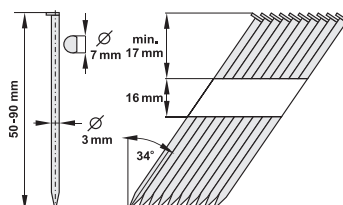

BMC & COLOR SLEEVE 

- application: industry, construction
- przeznaczenie: przemysł, budownictwo

YATO 
YT-0923  2

16

Special automotive tools & equipment
Narzędzia i wyposażenie
warsztatu samochodowego



Cabinets Szafki		295-311
---------------------------	---	---------

Roller cabinets with tools insert Szafki serwisowe z narzędziami	295
Tool cabinets Szafki serwisowe	300
Workbenches Stoły warsztatowe	303
Tools in PVC trays Zestawy narzędzi do szuflad	304
Accessories for tool cabinets & workbenches Akcesoria do szafek i stołów	310

Tool boxes Skrzynki narzędziowe		312-314
---	---	---------

Lubrication system tools Narzędzia do obsługi układu smarowania		315-321
---	---	---------

Oil filter wrenches & sets Klucze do filtra oleju i zestawy	315
Oil drain plug sockets Klucze do spustu oleju	317
Grease guns & accessories Smarownice ręczne, pneumatyczne i akcesoria	318
Oil cans Oliwiarki	321
Oil and fuel pumps Pompy do oleju oraz paliwa	321

Pullers Ściągacze		322-334
-----------------------------	---	---------

Pullers Ściągacze	322
Roller stud extractor sets Zestawy ściągaczy do szpilek	327
Upholstery removers Ściągacze do tapicerki	334

Car window tools Narzędzia do szyb samochodowych		334-335
--	---	---------

Fuel feel pipe pliers Szczypce motoryzacyjne		336-340
--	---	---------

Engine repair tools Narzędzia do obsługi silnika		341-353
--	---	---------

Piston ring compressors Zaciskacze do pierścieni	341
Engine repair and diagnostic tools Narzędzia do diagnostyki i naprawy silników	341
Spark plug sockets Klucze do świec	353

Brake system tools Narzędzia do obsługi układu hamulcowego		354-358
--	---	---------

Suspension system tools Narzędzia do obsługi podwozia		359-362
---	---	---------

Spring clamps & accessories Ściągacze do sprężyn i akcesoria	359
Shock absorber nut sets Zestawy nasadek do amortyzatorów	360
Tire valve stem inserter Przeciągacze do zaworów gumowych	360
Wheel balance pliers Szczypce do wyważania kół	361
Deep thin wall impact sockets 1/2" Udarowe klucze nasadowe 1/2" do felg aluminiowych	361
Valve core torque tools Klucze dynamometryczne do zaworków gumowych i metalowych	361
Wheel wrenches Klucze do kół	361
Tire levels Łyżki do opon	362

Workshop tools Narzędzia warsztatowe		363-372
--	---	---------

Inspection tools Narzędzia inspekcyjne	363
Magnetic pick up tools Chwytniki magnetyczne	364
Magnetic trays Tacki magnetyczne	364
Tweezers Pęsety	365
Workshop creepers Leżanki warsztatowe	365
LED workshop lightning Oświetlenie warsztatowe LED	366
Flashlights Latarki	370
Voltage testers Próbniki napięcia	371
Number & letter stamps Znaczniki cyfrowe i literowe	371
Thread repair sets & accessories Zestawy do naprawy gwintów i akcesoria	371
Tire pressure gauges Mierniki ciśnienia	372
Pumps Pompki	372

Funnels, oil drainer & drainer pans Lejki, miski i zlewarki do oleju		373
--	---	-----

Bottle & floor jacks Dźwigniki słupkowe i podnośniki		374-375
--	---	---------

Jack stands
Podstawki pod samochód

375



Electric hoists
Elektryczne wciągarki linowe

379



Battery chargers & battery testers
Prostowniki i testery akumulatorów

376-378



Hand pullers
Wciągarki linowe, ręczne

379



Refractometers
Refraktometry

378



Shop cranes & shop presses
Żurawie i prasy warsztatowe

380-381



Chain blocks
Wciągarki łańcuchowe

379



Workshop standardized parts
Normalia motoryzacyjne

382-392



GB Service tool cabinet with tools
D Serviceschrank mit Werkzeugen
PL Szafka serwisowa z narzędziami
RUS Сервисный шкаф с инструментами
CZ Servisní skříňka s náradím
H Szervizszekrény szerszámmal

RO Cutie de service cu scule
F Servante d'atelier - set d'outils
I Armadio per utensili
E Armario para herramientas de servicio
CN 工具车托盘组套

WHITE
CARTON BOX
& COLOR LABEL



141 PCS
12 TRAY
WKLAD

932x665
x453 mm

7x

BALL BEARING
ŁOŻYSKA
KULKOWE

25kg
35kg
35kg

CENTRAL LOCK
CENTRALNY ZAMEK

WHEELS
FOŁKI
125 mm

2x BRAKE
HAMULCE

NON SLIP
WORKTOP
BLAT
ANTIPOŚLIZGOWY

UNIVERSAL PERFORMANCE
UNIERSALNA PERFORACJA

2x



12 interchangeable trays with YATO tools
12 wymiennych modułów z narzędziami YATO

DRAWER / SZUFLADA 1

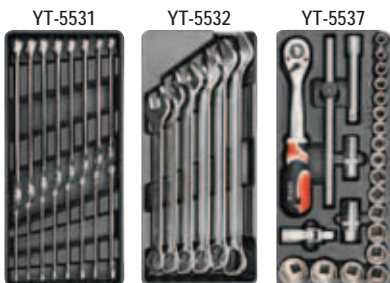

YT-5531

YT-5532

YT-5537

DRAWER / SZUFLADA 2

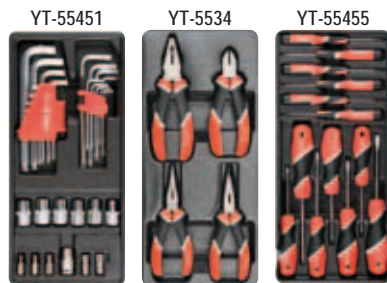

YT-55451

YT-5534

YT-55455

DRAWER / SZUFLADA 3



YT-5540

YT-55473

YT-55471

DRAWER / SZUFLADA 4



YT-55453

YT-55474

YT-55466

DRAWER / SZUFLADA 1

1/2" (12.7 mm): 10, 11, 12, 13, 14, 15, 16, 17, 18, 19, 20, 21, 22, 23, 24, 27, 30, 32 mm; CrV 50BV30; 1/2" (12.7 mm): (255 mm); 72T: CrV 6140; 1/2" (12.7 mm): (255 mm); CrV 50BV30; 1/2" (12.7 mm): 16; 21 mm; CrV 50BV30; 1/2" (12.7 mm): (127 mm); CrV 50BV30; 1/2" (12.7 mm): CrV 50BV30; 6, 7, 8, 9, 10, 11, 12, 13, 14, 15, 16, 17, 18, 19, 20, 21 mm; CrV: 22, 24, 27, 28, 30, 32 mm; CrV

DRAWER / SZUFLADA 2

1/2" (12.7 mm): E10, E12, E14, E16, E18, E20 (L=38 mm); CrV 50BV30; M5, M6, M8, M10, M12 (L=30 mm); AISI S2; 1/2" (12.7 mm): 10 mm; CrV 6150; 2, 2.5, 3, 4, 5, 6, 7, 8, 10, 12 mm; CrV 6150; T10, T15, T20, T25, T27, T30, T40, T45, T50; CrV 6150; 180 mm; 160 mm; 160 mm; LONG NOSE: 160 mm BENT NOSE: 3x75, 4x100, 5x75, 6x100 mm; PH0x75, PH1x75, PH2x100 mm; S2: 1.4x50, 2.0x50, 2.4x50 mm; PH00x50, PH0x50, PH1x50 mm; S2

DRAWER / SZUFLADA 3

300 g (L=300 mm); 40 mm (L=350 mm); 250 mm; CrV: 10x8x142 mm, 12x10x152 mm, 16x13x172 mm; 250 mm; CrV: 125 mm; CrMo; 300 mm; CrV: 140 mm; 200 mm; 19 mm x 20 mm; 4x190 mm; 250 V: 1.0, 1.5, 2.0, 2.5, 3.0, 3.5, 4.0, 4.5, 5.0, 5.5, 6.0, 6.5, 7.0, 7.5, 8.0, 8.5, 9.0, 9.5, 10.0 mm

DRAWER / SZUFLADA 4

#2, 200 mm; #2, 200 mm; #2, 200 mm; #2, 200 mm; 300 mm; 0-150 mm; 2 m; 3m x 16 mm; 0.02-1.00 mm; 2.4, 3.2, 4.0, 4.8 mm; 9.6x3.2, 9.6x4.0, 12.7x4.0, 9.6x4.8, 12.7x4.8 mm

YATO drawers / szuflady		
YT-55291	7	1

GB Service tool cabinet with tools
 D Serviceschrank mit Werkzeugen
 PL Szafka serwisowa z narzędziami
 RUS Сервисный шкаф с инструментами
 CZ Servisní skříňka s nářadím
 H Szervizszekrény szerszámmal

RO Cutie de service cu scule
 F Servante d'atelier - set d'outils
 I Armadio per utensili
 E Armario para herramientas de servicio
 CN 工具车托盘组套

WHITE
 CARTON BOX
 & COLOR LABEL



165 PCS 13 TRAY WKŁAD	958x766 x465 mm	7x	BALL BEARING ŁOŻYSKA KULKOWE	25kg 35kg 35kg
DRAWERS LOCKING BŁOKADA SZUFLAD	CENTRAL LOCK CENTRALNY ZAMEK	NON SLIP WORKTOP BLAT ANTYPOŚLIZGOWY	WHEEL Ø 125 mm	BRAKE HAMULEC
3x	UNIVERSAL PERFORMANCE UNIERSALNA PERFORACJA	DOUBLE WALLS PODWÓJNE ŚCIANY	CORNER BUMPERS NARÓZNE ODBOJNIKI	



13 interchangeable trays with YATO tools
 13 wymiennych modułów z narzędziami YATO

DRAWER / SZUFLADA 1

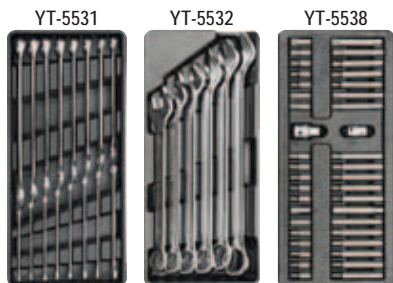

DRAWER / SZUFLADA 2

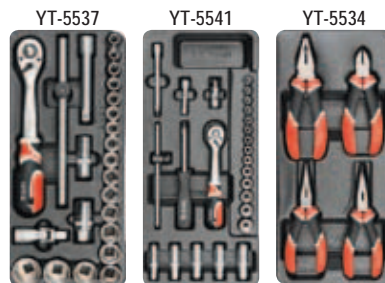

DRAWER / SZUFLADA 3

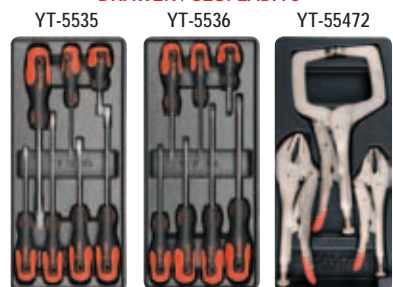

DRAWER / SZUFLADA 4

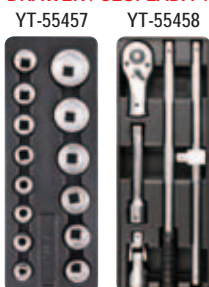

DRAWER / SZUFLADA 5



DRAWER / SZUFLADA 1

○ □ □ H4, H5, H6, H7, H8, H10, H12 (L=30 mm); H4, H5, H6, H7, H8, H10, H12 (L=75 mm); AISI S2: ○ □ □ M5, M6, M8, M10, M12 (L=30 mm); M5, M6, M8, M10, M12 (L=75 mm); AISI S2: ○ □ □ T20, T25, T30, T40, T45, T50, T55 (L=30 mm); T20, T25, T30, T40, T45, T50, T55 (L=75 mm); AISI S2: □ □ □ 1/2" (12.7 mm), 3/8" (9.5 mm); ○ □ □ 6, 7, 8, 9, 10, 11, 12, 13, 14, 15, 16, 17, 18, 19, 20, 21 mm; CrV: ○ □ □ 22, 24, 27, 28, 30, 32 mm; CrV

DRAWER / SZUFLADA 2

□ □ □ 1/2" (12.7 mm): 10, 11, 12, 13, 14, 15, 16, 17, 18, 19, 20, 21, 22, 23, 24, 27, 30, 32 mm; CrV 50BV30: ○ □ □ 1/2" (12.7 mm): (255 mm); 72T: CrV 6140: ○ □ □ 1/2" (12.7 mm): (255 mm); CrV 50BV30: ○ □ □ 1/2" (12.7 mm): (127 mm); CrV 50BV30: ○ □ □ 1/2" (12.7 mm); CrV 50BV30: ○ □ □ 1/4" (6.3 mm): 3.5, 4.0, 4.5, 5.0, 5.5, 6.0, 7.0, 8.0, 9.0, 10.0, 11.0, 12.0, 13.0, 14.0 mm; CrV 50BV30: ○ □ □ 1/4" (6.3 mm): 8, 10, 11, 12, 13 mm; CrV 50BV30: ○ □ □ 1/4" (6.3 mm): (50.8, 101.6 mm); CrV 6140: ○ □ □ 1/4" (6.3 mm): CrV 50BV30: ○ □ □ 1/4" (6.3 mm): (155 mm); 72T: CrV 6140: ○ □ □ 1/4" (6.3 mm): (150 mm); CrV 50BV30: ○ □ □ 180 mm; 1/4" (6.3 mm): (152.4 mm); CrV 50BV30: ○ □ □ 160 mm; 160 mm LONG NOSE: ○ □ □ 160 mm BENT NOSE

DRAWER / SZUFLADA 3

○ □ □ 3x75, 5x100, 5x150, 6x38, 6x100, 6x150, 8x150 mm; CrMo; ○ □ □ PH0x100, PH1x75, PH1x100, PH2x38, PH2x100, PH2x150, PH3x150 mm; CrMo; ○ □ □ 180, 250 mm; ○ □ □ 280 mm

DRAWER / SZUFLADA 4

□ □ □ 3/4" (19.0 mm): 21, 22, 24, 27, 28, 29, 30, 32, 34, 36, 41, 46, 50, 55 mm; CrV 50BV30: ○ □ □ 3/4" (19.0 mm): (200 mm); CrV 6140: ○ □ □ 3/4" (19.0 mm); CrV 50BV30: ○ □ □ 3/4" (19.0 mm); (500 mm); 72T: CrV 6140: ○ □ □ 3/4" (19.0 mm): (500 mm); CrV 50BV30

DRAWER / SZUFLADA 5

○ □ □ 1/2" (12.7 mm) x 5/16" (7.9 mm); ○ □ □ PH3 (L=35 mm); PH1, PH2, PH3 (L=75 mm); ○ □ □ 8 mm (L=35 mm); 8 mm (L=75 mm); ○ □ □ 12-38 mm; ○ □ □ 3" (75 mm); ○ □ □ 82 mm; ○ □ □ 200 mm; ○ □ □ 135 mm; ○ □ □ 300, 400, 500 mm

YATO	drawers / szuflady	
YT-55293	7	1

GB Service tool cabinet with tools
D Serviceschrank mit Werkzeugen
PL Szafka serwisowa z narzędziami
RUS Сервисный шкаф с инструментами
CZ Servisní skříňka s nářadím
H Szervizszekrény szerszámmal

RO Cutie de service cu scule
F Servante d'atelier - set d'outils
I Armadio per utensili
E Armario para herramientas de servicio
CN 工具车托盘组套

WHITE
CARTON BOX
& COLOR LABEL



177 PCS
12 TRAY WKLD

958x766
x465 mm

6x

BALL BEARING
ŁOŻYSKA
KULKOWE

28kg
35kg
35kg

DRAWERS
LOCKING
BLOKADA
SZUFLAD

NON SLIP
POLYPROPYLENE
WORKTOP
ANTYPOŚLIZGOWY
POLIPROPYLENOWY
BLAT

WHEEL Ø
125 mm

BRAKE
HAMULEC

UNIVERSAL
PERFORMANCE
UNIWERSALNA
PERFORACJA

DOUBLE
WALLS
PODWÓJNE
SCIANY

2x

CORNER BUMPERS
NARÓŻNE ODBOJNIKI



12 interchangeable trays with YATO tools
12 wymiennych modułów z narzędziami YATO

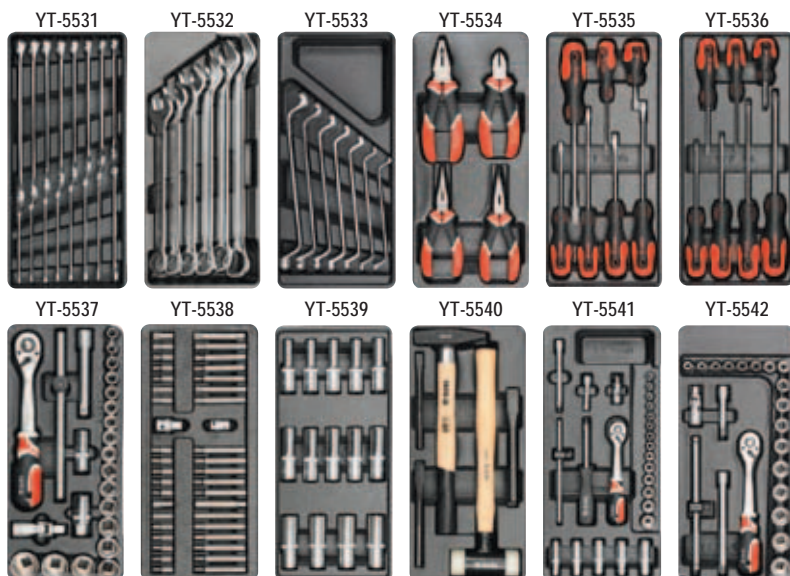

DRAWER / SZUFLADA 1

3/8" (9.5 mm): 6, 7, 8, 9, 10, 11, 12, 13, 14, 15, 16, 17, 18, 19, 20, 21, 22 mm; CrV 50BV30; 3/8" (9.5 mm): (76, 152.4 mm); CrV 50BV30; 3/8" (9.5 mm); CrV 50BV30; 3/8" (9.5 mm); (200 mm); 72T; CrV 6140; 3/8" (9.5 mm); (198 mm); CrV 50BV30; 1/2" (12.7 mm): 10, 11, 12, 13, 14, 15, 16, 17, 18, 19, 20, 21, 22, 23, 24, 27, 30, 32 mm; CrV 50BV30; 1/2" (12.7 mm); (127 mm); CrV 50BV30; 1/2" (12.7 mm); CrV 50BV30; 1/2" (12.7 mm); (255 mm); 72T; CrV 6140; 1/2" (12.7 mm); (255 mm); CrV 50BV30; 1/2" (12.7 mm); 16; 21 mm; CrV 50BV30; 1/4" (6.3 mm): 3.5, 4, 4.5, 5, 5.5, 6, 7, 8, 9, 10, 11, 12, 13, 14 mm; CrV 50BV30; 1/4" (6.3 mm): 8, 10, 11, 12, 13 mm; CrV 50BV30; 1/4" (6.3 mm): (50.8, 101.6 mm); CrV 6140; 1/4" (6.3 mm); CrV 50BV30; 1/4" (6.3 mm); (155 mm); 72T; CrV 6140; 1/4" (6.3 mm); (152.4 mm); CrV 50BV30

DRAWER / SZUFLADA 2

3x75, 5x100, 5x150, 6x38, 6x100, 6x150, 8x150 mm; CrMo; PH0x100, PH1x75, PH1x100, PH2x38, PH2x100, PH2x150, PH3x150 mm; CrMo; 180 mm; 160 mm; 160 mm LONG NOSE; 160 mm BENT NOSE

DRAWER / SZUFLADA 3

22, 24, 27, 28, 30, 32 mm; CrV; 6, 7, 8, 9, 10, 11, 12, 13, 14, 15, 16, 17, 18, 19, 20, 21 mm; CrV; 1/2" (12.7 mm): 8, 9, 10, 11, 12, 13, 14, 15, 16, 17, 18, 19, 20, 21 mm (L=76 mm); CrV 50BV30

DRAWER / SZUFLADA 4

300 g (L=300 mm); 40 mm (L=350 mm); 10x8x142 mm, 12x10x152 mm, 16x13x172 mm; H4, H5, H6, H7, H8, H10, H12 (L=30 mm); H4, H5, H6, H7, H8, H10, H12 (L=75 mm); AISI S2; M5, M6, M8, M10, M12 (L=30 mm); M5, M6, M8, M10, M12 (L=75 mm); AISI S2; T20, T25, T30, T40, T45, T50, T55 (L=30 mm); T20, T25, T30, T40, T45, T50, T55 (L=75 mm); AISI S2; 1/2" (12.7 mm); 3/8" (9.5 mm); 6x7, 8x9, 10x11, 12x13, 14x15, 16x17, 18x19 mm; CrV

YATO	drawers / szuflady	
YT-5530	6	1

GB Service tool cabinet with tools
 D Serviceschrank mit Werkzeugen
 PL Szafka serwisowa z narzędziami
 RUS Сервисный шкаф с инструментами
 CZ Servisní skříňka s náradím
 H Szervizszekrény szerszámmal

RO Cutie de service cu scule
 F Servante d'atelier - set d'outils
 I Armadio per utensili
 E Armario para herramientas de servicio
 CN 工具车托盘组套

WHITE
 CARTON BOX
 & COLOR LABEL



189 PCS 14 TRAY W/ K/LAD	958x766 x465 mm	7x 	BALL BEARING ŁOŻYSKA KULKOWE	 25kg 35kg
DRAWERS LOCKING BLOKADA SZUFLAD	CENTRAL LOCK CENTRALNY ZAMEK	NON SLIP WORKTOP BLAT ANTIPOŚLIZGOWY	WHEEL ϕ 125 mm KOŁA	BRAKE HAMULEC
3x	UNIVERSAL PERFORMANCE UNIWEKSAŁNA PERFORACJA	DOUBLE WALLS PODWÓJNE SCIANY	CORNER BUMPERS NARÓZNE ODBOJNIKI	



DRAWER / SZUFLADA 1

○ □ ▢ H4, H5, H6, H7, H8, H10, H12 (L=30 mm); H4, H5, H6, H7, H8, H10, H12 (L=75 mm); AISI S2: ○ □ ▢ M5, M6, M8, M10, M12 (L=30 mm); M5, M6, M8, M10, M12 (L=75 mm); AISI S2: ○ □ ▢ T20, T25, T30, T40, T45, T50, T55 (L=30 mm); T20, T25, T30, T40, T45, T50, T55 (L=75 mm); AISI S2: □ ▢ 1/2" (127 mm), 3/8" (9.5 mm); 6, 7, 8, 9, 10, 11, 12, 13, 14, 15, 16, 17, 18, 19, 20, 21 mm; CrV; 22, 24, 27, 28, 30, 32 mm; CrV

DRAWER / SZUFLADA 2

□ 1/2" (12.7 mm): 10, 11, 12, 13, 14, 15, 16, 17, 18, 19, 20, 21, 22, 23, 24, 27, 30, 32 mm; CrV 50BV30; 1/2" (12.7 mm); (255 mm); 72T; CrV 6140; 1/2" (12.7 mm); (255 mm); CrV 50BV30; 1/2" (12.7 mm); 16; 21 mm; CrV 50BV30; 1/2" (12.7 mm); (127 mm); CrV 50BV30; 1/2" (12.7 mm); CrV 50BV30; 180 mm; 160 mm; 160 mm LONG NOSE; 160 mm BENT NOSE; 300 g (L=300 mm); 40 mm (L=350 mm); 10x8x142 mm, 12x10x152 mm, 16x13x172 mm

DRAWER / SZUFLADA 3

3x75, 4x100, 5x75, 6x100 mm; PH0x75, PH1x75, PH2x100 mm; S2; 1.4x50, 2.0x50, 2.4x50 mm; PH00x50, PH0x50, PH1x50 mm; S2; 6x150, 8x200; PH2x150, PH3x200; CrV; 200, 250 mm; CrV; 250 mm; CrMo; 150 mm; CrV

DRAWER / SZUFLADA 4

3x: M3x0.5, M4x0.7, M5x0.8, M6x1.0, M7x1.0, M8x1.25, M10x1.5, M12x1.75; M3x0.5, M4x0.7, M5x0.8, M6x1.0, M7x1.0, M8x1.25, M10x1.5, M12x1.75; 0.5 - 1.75 mm; 27G; 28G; M7-M9; M3-M12; 180 mm; EXTERNAL STRAIGHT; 180 mm; INTERNAL STRAIGHT; 180 mm; EXTERNAL BENT; 180 mm; INTERNAL BENT; #2, 200 mm; #2, 200 mm; #2, 200 mm; #2, 200 mm; #2, 200 mm

DRAWER / SZUFLADA 5

140 mm; 200 mm; 19 mm x 20 mm; 4x190 mm; 250 V; 1.0, 1.5, 2.0, 2.5, 3.0, 3.5, 4.0, 4.5, 5.0, 5.5, 6.0, 6.5, 7.0, 7.5, 8.0, 8.5, 9.0, 9.5, 10.0 mm; 1" (25 mm); (L=330 mm); 250 mm; 2.4, 3.2, 4.0, 4.8 mm; 9.6x3.2, 9.6x4.0, 12.7x4.8 mm

YATO	drawers / szuflady	
YT-55292	7	1

14 interchangeable trays
 with YATO tools
 14 wymiennych modułów
 z narzędziami YATO

DRAWER / SZUFLADA 1

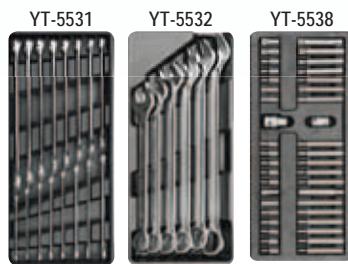

DRAWER / SZUFLADA 2

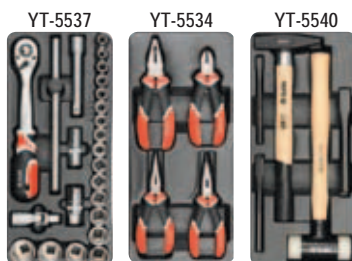

DRAWER / SZUFLADA 3

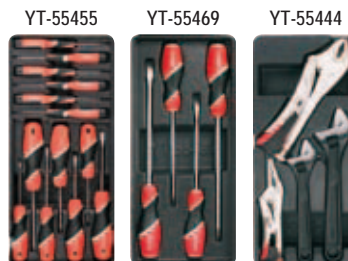

DRAWER / SZUFLADA 4

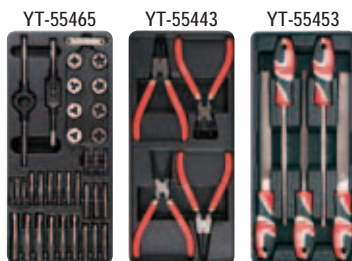

DRAWER / SZUFLADA 5



GB Service tool cabinet with tools
D Serviceschrank mit Werkzeugen
PL Szafka serwisowa z narzędziami
RUS Сервисный шкаф с инструментами
CZ Servisní skříňka s nářadím
H Szervizszekrény szerszámmal

RO Cutie de service cu scule
F Servante d'atelier - set d'outils
I Armadio per utensili
E Armario para herramientas de servicio
CN 工具车托盘组套

WHITE
CARTON BOX
& COLOR LABEL



211 PCS 5 TRAY WKLD	980x770 x465 mm	7x	BALL BEARING ŁOŻYSKA KULKOWE	25kg 35kg
DRAWERS LOCKING BLOKADA SZUFLAD	NON SLIP WORKTOP ANTIPOŚLIZGOWY POLIPROPILENOWY BLAT	3x	SAFETY Ø 125 mm	2x BRAKE HAMULCE
		UNIVERSAL PERFORMANCE UNIERSALNA PERFORACJA	DOUBLE WALLS PODWÓJNE ŚCIANY	CORNER BUMPERS NARÓŻNE ODOBJNIKI



DRAWER / SZUFLADA 1

1/2" (12.7 mm): 8, 9, 10, 11, 12, 13, 14, 15, 16, 17, 18, 19, 20, 21, 22, 24 (L=38 mm); 27, 30, 32 mm (L=42 mm); 1/4" (6.3 mm): 4, 4.5, 5, 5.5, 6, 7, 8, 9, 10, 11, 12, 13 (L=25 mm); CrV 50BV30: 1/2" (12.7 mm): 10, 13, 14, 15, 17, 19, 21 mm (L=76 mm); 1/4" (6.3 mm): 6, 7, 8, 9, 10, 11, 12, 13 (L=50 mm); CrV 50BV30: 1/2" (12.7 mm): E10, E11, E12, E14, E16, 1/4" (6.3 mm): E4, E5, E6, E7, E8; CrV 50BV30: 1/2" (12.7 mm): (127, 254 mm); 1/4" (6.3 mm): (50.8, 101.6 mm); CrV 50BV30: 1/2" (12.7 mm): CrV 50BV30: 1/2" (12.7 mm): 16, 21 mm; CrV 50BV30: 1/2" (12.7 mm): (255 mm); 1/4" (6.3 mm): (152.4 mm); CrV 50BV30: 1/2" (12.7 mm): (255 mm); 1/4" (6.3 mm): (155 mm); CrV 6140: 1/4" (6.3 mm): (150 mm); CrV 50BV30: 1/4" (6.3 mm): 4, 5.5, 6.5 mm; AISI S2 / CrV 6150: 1/4" (6.3 mm): PH1 (x2), PH2 (x2), PH3; AISI S2 / CrV 6150: 1/4" (6.3 mm): PZ1, PZ2, PZ3; AISI S2 / CrV 6150: 1/4" (6.3 mm): T8, T10, T15, T20, T25, T30, T40; AISI S2 / CrV 6150: 3, 4, 5, 6, 7, 8 mm; AISI S2 / CrV 6150

DRAWER / SZUFLADA 2

200 mm; CrV: Ø 3-6 mm (L=52 mm), Ø 6-9 (L=58 mm), Ø 8-11 (L=66 mm), Ø 11-14 (L=75 mm), Ø 14-18 (L=80 mm), Ø 18-25 (L=88 mm); 8, 9, 10, 11, 12, 13, 14, 15, 16, 17, 18, 19, 21, 22, 24 mm; CrV: T10, T15, T20, T25, T27, T30, T40, T45, T50; CrV 6150: 2, 2.5, 3, 4, 5, 6, 7, 8, 10, 12 mm; CrV 6150

DRAWER / SZUFLADA 3

6.0x38, 2.0x75, 3.0x75, 4.0x100, 5.0x100, 6.0x100 mm; PH0x100, PH1x100, PH2x38, PH2x150, PH3x150 mm; T7x75, T8x75, T9x75, T10x100, T15x100, T20x100, T25x100, T27x100 mm; S2; 6.0x150 mm; PH2x150 mm; CrV 6150

DRAWER / SZUFLADA 4

180 mm; 160 mm; 200 mm; 250 mm; 400g; 340g; 12.5x152, 16.0x172 mm; CrV 6150; 3.0x150, 4.0x150, 5.0x150, 6.0x150, 8.0x150 mm; CrV 6150; 8.0x112 mm; CrV 6150

DRAWER / SZUFLADA 5

M3x0.5 (x3), M4x0.7 (x3), M5x0.8 (x3), M6x1.0 (x3), M7x1.0 (x3), M8x1.25 (x3), M10x1.5 (x3), M12x1.75 (x3); HSS M2: M3, M4x0.7, M5x0.8, M6x1.0, M7x1.0, M8x1.25, M10x1.5, M12x1.75; HSS M2: M7-M9; #2, 200 mm; #2, 200 mm; #2, 200 mm; LED; 3 m x 16 mm; 300 mm; 0-150 mm

YATO drawers / szuflady		
YT-55290	7	1

DRAWER / SZUFLADA 1

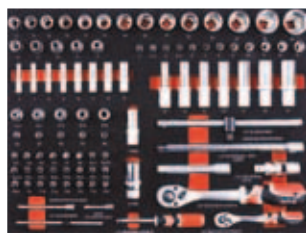

DRAWER / SZUFLADA 2



DRAWER / SZUFLADA 3



DRAWER / SZUFLADA 4



DRAWER / SZUFLADA 5

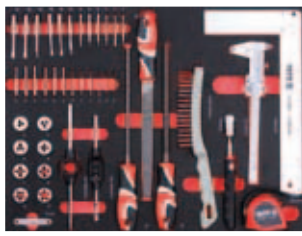

CREATE YOUR WORKPLACE - STWÓRZ SWOJE MIEJSCE PRACY

YT-09061



YT-08921

YT-09152



YT-08922



YT-08920

- GB Tool chest
- D Werkzeugkasten
- PL Szafka warsztatowa
- RUS Портативный ящик для инструментов
- CZ Přenosná skříňka na nářadí
- H Hordozható szerszámok láda
- RO Cutie pt. instrumente portabile
- F Servante d'atelier
- I Banco da lavoro armadio
- E Cajonera portátil
- CN 驮鞍箱



690x465
x400 mm



NON SLIP
ABS
WORKTOP
ANTYPOŚLIZGOWY
BLAT
Z TWORZYWA ABS



UNIVERSAL
PERFORATION
UNIWEERSALNA
PERFORACJA

DRAWERS
LOCKING
BLOKADA
SZUFLAD

CENTRAL
LOCK
CENTRALNY
ZAMEK



2x1

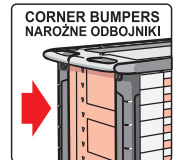

DOUBLE
WALLS
PODWÓJNE
SCIANY



WHITE
CARTON BOX
& COLOR LABEL

YATO 	drawers / szuflady	
YT-09152	4	1

16

- GB Tool chest
- D Werkzeugkasten
- PL Szafka warsztatowa
- RUS Портативный ящик для инструментов
- CZ Přenosná skříňka na nářadí
- H Hordozható szerszámok láda
- RO Cutie pt. instrumente portabile
- F Servante d'atelier
- I Banco da lavoro armadio
- E Cajonera portátil
- CN 驮鞍箱



690x465
x535 mm



NON SLIP
ABS
WORKTOP
ANTYPOŚLIZGOWY
BLAT
Z TWORZYWA ABS



UNIVERSAL
PERFORATION
UNIWEERSALNA
PERFORACJA

DRAWERS
LOCKING
BLOKADA
SZUFLAD

CENTRAL
LOCK
CENTRALNY
ZAMEK



2x1

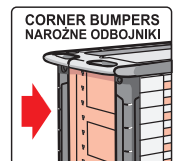

DOUBLE
WALLS
PODWÓJNE
SCIANY



WHITE
CARTON BOX
& COLOR LABEL

YATO 	drawers / szuflady	
YT-09155	6	1

- GB Roller cabinet
- D Werkstattrollwagen
- PL Szafka serwisowa
- RUS Инструментальный кабинет
- CZ Dílenská skříňka
- H Szerviz - szekrény
- RO Dulap de scule
- F Servante d'atelier
- I Armadio per utensili
- E Armario en ruedas
- CN 工具车



1000x1130 x570 mm	6+1	BALL BEARING ŁOŻYSKA KULKOWE	25kg 35kg 35kg
OIL PROOF STEEL WORKTOP OLEJODOPORNY STALOWY BLAT	DRAWERS LOCKING BLOKADA SZUFLAD	WHEEL Ø 160 mm	BRAKE HAMULEC
UNIVERSAL PERFORATION UNIWEERSALNA PERFORACJA	DOUBLE WALLS PODWÓJNE SCIANY	CORNER BUMPERS NAROŻNE ODBOJNIKI	
2x T			

WHITE
CARTON BOX
& COLOR LABEL



YATO	drawers / szuflady	
YT-09002	6+1	1

- GB Roller cabinet
- D Werkstattrollwagen
- PL Szafka serwisowa
- RUS Инструментальный кабинет
- CZ Dílenská skříňka
- H Szerviz - szekrény
- RO Dulap de scule
- F Servante d'atelier
- I Armadio per utensili
- E Armario en ruedas
- CN 工具车







1000x1130 x570 mm	12x	BALL BEARING ŁOŻYSKA KULKOWE	25kg 35kg 35kg
OIL PROOF STEEL WORKTOP OLEJODOPORNY STALOWY BLAT	DRAWERS LOCKING BLOKADA SZUFLAD	WHEEL Ø 160 mm	BRAKE HAMULEC
UNIVERSAL PERFORATION UNIWEERSALNA PERFORACJA	DOUBLE WALLS PODWÓJNE SCIANY	CORNER BUMPERS NAROŻNE ODBOJNIKI	
2x T			

WHITE
CARTON BOX
& COLOR LABEL



YATO	drawers / szuflady	
YT-09003	12	1



GB Roller cabinet
 D Werkstattrollwagen
 PL Szafka serwisowa
 RUS Инструментальный кабинет
 CZ Dilenská skříňka
 H Szerviz - szekrény
 RO Dulap de scule
 F Servante d'atelier
 I Armadio per utensili
 E Armario en ruedas
 CN 工具车

995x680 x458mm	 6x	 DRAWERS LOCKING BLOKADA SZUFLAD	 CENTRAL LOCK CENTRALNY ZAMEK	 NON SLIP POLYPROPYLENE WORKTOP ANTYPOŚLIZGOWY POLIPROPYLENOWY BLAT
300 kg max.	 BALL BEARING ŁOŻYSKA KULKOWE	 WHEEL Ø 127 mm *10L* (25.4 mm)	 2x BRAKE HAMULCE	 2x 











WHITE
 CARTON BOX
 & COLOR LABEL



YATO 	drawers / szuflady	
YT-0913	6	1



GB Roller cabinet
 D Werkstattrollwagen
 PL Szafka serwisowa
 RUS Инструментальный кабинет
 CZ Dilenská skříňka
 H Szerviz - szekrény
 RO Dulap de scule
 F Servante d'atelier
 I Armadio per utensili
 E Armario en ruedas
 CN 工具车

995x680 x458mm	 7x	 DRAWERS LOCKING BLOKADA SZUFLAD	 CENTRAL LOCK CENTRALNY ZAMEK	 NON SLIP POLYPROPYLENE WORKTOP ANTYPOŚLIZGOWY POLIPROPYLENOWY BLAT
300 kg max.	 BALL BEARING ŁOŻYSKA KULKOWE	 WHEEL Ø 127 mm *10L* (25.4 mm)	 2x BRAKE HAMULCE	 2x 















WHITE
 CARTON BOX
 & COLOR LABEL



YATO 	drawers / szuflady	
YT-0914	7	1



GB Roller cabinet
 D Werkstattrollwagen
 PL Szafka serwisowa
 RUS Инструментальный кабинет
 CZ Dilenská skříňka
 H Szerviz - szekrény
 RO Dulap de scule
 F Servante d'atelier
 I Armadio per utensili
 E Armario en ruedas
 CN 工具车

958x766 x465 mm	 6x	 DRAWERS LOCKING BLOKADA SZUFLAD	 NON SLIP POLYPROPYLENE WORKTOP ANTYPOŚLIZGOWY POLIPROPYLENOWY BLAT	 25kg 35kg
 BALL BEARING ŁOŻYSKA KULKOWE	 WHEEL Ø 125 mm *10L*	 UNIVERSAL PERFORATION UNIWERSALNA PERFORACJA	 DOUBLE WALLS PODWÓJNE ŚCIANY	 2x 
 BRAKE HAMULEC	 CORNER BUMPERS NAROŻNE ODBOJNIKI			



WHITE
 CARTON BOX
 & COLOR LABEL



YATO 	drawers / szuflady	
YT-0902	6	1



GB Roller cabinet
 D Werkstattrollwagen
 PL Szafka serwisowa
 RUS Инструментальный кабинет
 CZ Dilenská skříňka
 H Szerviz - szekrény
 RO Dulap de scule
 F Servante d'atelier
 I Armadio per utensili
 E Armario en ruedas
 CN 工具车

932x665 x453 mm	 7x	 DRAWERS LOCKING BLOKADA SZUFLAD	 NON SLIP POLYPROPYLENE WORKTOP ANTYPOŚLIZGOWY POLIPROPYLENOWY BLAT	 25kg 35kg
 CENTRAL LOCK CENTRALNY ZAMEK	 WHEEL Ø 125 mm *10L*	 2x BRAKE HAMULCE	 UNIVERSAL PERFORATION UNIWERSALNA PERFORACJA	 2x 



WHITE
 CARTON BOX
 & COLOR LABEL



YATO 	drawers / szuflady	
YT-09000	7	1

- GB Roller cabinet
D Werkstattrollwagen
PL Szafka serwisowa
RUS Инструментальный кабинет
CZ Dilenská skříňka
H Szerviz - szekrény
RO Dulap de scule
F Servante d'atelier
I Armadio per utensili
E Armario en ruedas
CN 工具车



995x950 x550 mm	7x	BALL BEARING ŁOŻYSKA KULKOWE	NON SLIP POLYPROPYLENE WORKTOP ANTYPOŚLIZGOWY POLIPROPILENOWY BLAT
DRAWERS LOCKING BLOKADA SZUFLAD	CENTRAL LOCK CENTRALNY ZAMEK	WHEELS 127 mm 1" (25.4 mm)	2x BRAKE HAMULCE
UNIVERSAL PERFORATION UNIWERSALNA PERFORACJA	DOUBLE WALLS PODWÓJNE SCIANY	CORNER BUMPERS NAROŻNE ODBOJNIKI	

WHITE
CARTON BOX
& COLOR LABEL



YATO	drawers / szuflady	
YT-09008	7	1

- GB Shutter cabinet
D Werkstatt Hängeschrank
PL Szafka wisząca
RUS Шкафчик
для инструмента
настенный
CZ Závěsná skříňka
H Szerszámtároló
RO Raft de scule
F Placard d'atelier
I Scaffale
E Armario colgante
CN 橙螯揣



1375x714 x145 mm	CENTRAL LOCK CENTRALNY ZAMEK
UNIVERSAL PERFORATION UNIWERSALNA PERFORACJA	

WHITE
CARTON BOX
& COLOR LABEL



YATO	size / rozmiar (mm)	
YT-09061	1375x714x145	1

- GB Workbench
D Werkbank
PL Stół warsztatowy
RUS Бепстак
CZ Pracovní stůl
H Munkapad
RO Banc de lucru
F Table d'atelier
I Banco da lavoro
E Banco de trabajo
CN 工作台



1500x780 x830 mm	NON SLIP ABS WORKTOP ANTYPOŚLIZGOWY BLAT Z TWORZYWA ABS
---------------------	--

WHITE
CARTON BOX
& COLOR LABEL



YATO	size / rozmiar (mm)	
YT-08920	1500x780x830	1

GB Drawer insert / Combination spanners
D Schubladeneinlage / Schrauben- und Ringschlüssel
PL Wkład do szuflady / Klucze płasko-oczkowe
RUS Вклад к выдвижному ящику / Плоско-закрытый накладной ключ
CZ Vložka do zásuvky / Klíče ploché-očkové
H Fiókbetét / Csillag - villás kulcsok
RO Adaos la sertar / Chei plane - inelare
F Module plastique pour servante avec clés mixtes
I Tenone per l'armadio chiavi
E Accesorio de cajón / Llave española de muletilla
CN 两用扳手托盘组套

PLASTIC TRAY & COLOR LABEL



CrV



6
PCS

22, 24, 27, 28, 30, 32 mm; CrV

YATO
YT-5532 4

GB Drawer insert / Bi-hexagonal ring spanner
D Schubladeneinlage / Doppelringschlüssel
PL Wkład do szuflady / Klucze oczkowe odgięte
RUS Вклад к выдвижному ящику / Ключ накидной изогнутый
CZ Vložka do zásuvky / Klíče očkové ohnuté
H Fiókbetét / Hajlítotszárú csillagkulcs
RO Adaos la sertar / Chei inelaro-curbată
F Module plastique pour servante clés contre-coudées
I Tenone per l'armadio chiavi
E Accesorio de cajón / Llave de estrella
CN 双头高颈梅花扳手托盘组套

PLASTIC TRAY & COLOR LABEL



CrV

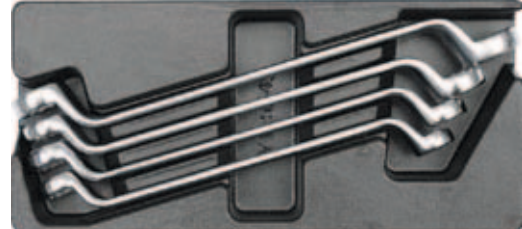

4
PCS

21x23, 24x27, 25x28, 30x32 mm; CrV

YATO
YT-5543 8



16
PCS

6, 7, 8, 9, 10, 11, 12, 13, 14, 15, 16, 17, 18, 19, 20, 21 mm; CrV

YATO
YT-5531 8



7
PCS

6x7, 8x9, 10x11, 12x13, 14x15, 16x17, 18x19 mm; CrV

YATO
YT-5533 8

GB Drawer insert / L-type socket wrench
D Schubladeneinlage / Steckschlüssel gebogen
PL Wkład do szuflady / Klucz nasadowy typ „L”
RUS Вклад к выдвижному ящику / Ключ торцевой L-типа
CZ Vložka do zásuvky / Nástrčný klíč fajkový
H Fiókbetét / Kulcs, dugó-pipa
RO Adaos la sertar / Cheie tubulara cu cot tip „L”
F Module plastique pour servante / Clé a douille de type „L”
I Tenone per l'armadio / Chiave a tubo tipo „L”
E Accesorio de cajón / Llave de vaso „L”
CN L型套筒扳手托盘组套

PLASTIC TRAY & COLOR LABEL



10
PCS

CrV



7, 8, 9, 10, 11, 12, 13, 14, 17, 19 mm

YATO
YT-55456 4

GB Drawer insert / Pliers
D Schubladeneinlage / Zangen
PL Wkład do szuflady / Szczypce
RUS Вклад к выдвижному ящику / Клещи
CZ Vložka do zásuvky / Kleště
H Fiókbetét / Fogó készlet
RO Adaos la sertar / Clește
F Module plastique pour servante avec pinces
I Tenone per l'armadio / Pinze
E Accesorio de cajón / Pinzas
CN 钳子托盘组套

PLASTIC TRAY & COLOR LABEL

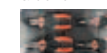

4
PCS

CrV



180 mm; 160 mm LONG NOSE;
160 mm; 160 mm BENT NOSE

YATO
YT-5534 8

GB Drawer insert / Pliers
D Schubladeneinlage / Zangen
PL Wkład do szuflady / Szczypce
RUS Вклад к выдвижному ящику / Клещи
CZ Vložka do zásuvky / Kleště
H Fiókbetét / Zégerfogó készlet
RO Adaos la sertar / Clește
F Module plastique pour servante avec pinces
I Tenone per l'armadio / Pinze
E Accesorio de cajón / Pinzas
CN 挡圈钳托盘组套

PLASTIC TRAY & COLOR LABEL

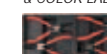

4
PCS

CrV



180 mm EXTERNAL STRAIGHT; 180 mm INTERNAL STRAIGHT;
180 mm EXTERNAL BENT; 180 mm INTERNAL BENT

YATO
YT-55443 8

- GB Drawer insert / Pliers
D Schubladeneinlage / Zangen
PL Wkład do szuflady / Szczypce
RUS Вклад к выдвижному ящику / Клещи
CZ Vložka do zásuvky / Kleště
H Fiókbetét / Fogók
RO Adaos la sertar / Clește
F Module plastique pour servante avec pinces
I Tenone per l'armadio / Pinze
E Accesorio de cajón / Pinzas
CN 钳子托盘组套

PLASTIC TRAY & COLOR LABEL



3
PCS

CrMo

CrV



YATO
YT-55463 8

- GB Drawer insert / Pliers
D Schubladeneinlage / Zangen
PL Wkład do szuflady / Szczypce
RUS Вклад к выдвижному ящику / Клещи
CZ Vložka do zásuvky / Kleště
H Fiókbetét / Fogók
RO Adaos la sertar / Clește
F Module plastique pour servante avec pinces
I Tenone per l'armadio / Pinze
E Accesorio de cajón / Pinzas
CN 钳子托盘组套

PLASTIC TRAY & COLOR LABEL



3
PCS

CrMo

CrV



YATO
YT-55472 8

- GB Drawer insert / Pliers
D Schubladeneinlage / Zangen
PL Wkład do szuflady / Szczypce
RUS Вклад к выдвижному ящику / Клещи
CZ Vložka do zásuvky / Kleště
H Fiókbetét / Fogók
RO Adaos la sertar / Clește
F Module plastique pour servante avec pinces
I Tenone per l'armadio / Pinze
E Accesorio de cajón / Pinzas
CN 钳子托盘组套

PLASTIC TRAY & COLOR LABEL



3
PCS

CrMo

CrV



YATO
YT-55473 8

- GB Drawer insert / Tool set for plumbers
D Schubladeneinlage / Werkzeug-Set für Klempner
PL Wkład do szuflady / Zestaw narzędziowy dla hydraulików
RUS Вклад к выдвижному ящику / Набор инструментов для водопроводчик
CZ Vložka do zásuvky / Sada nářadí pro instalatér
H Fiókbetét / Szerszámkészlet vízvezeték-szerelő
RO Adaos la sertar / Set de instrumente pt. instalator
F Module plastique pour servante / Un ensemble d'outils pour les plombier
I Tenone per l'armadio / Tool set per idraulici
E Accesorio de cajón / Un conjunto de herramientas para fontanero
CN 水管工具组套

PLASTIC TRAY & COLOR LABEL

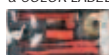

4
PCS

CrV

CrMo



YATO
YT-55480 5

- GB Drawer insert / Tool set for plumbers
D Schubladeneinlage / Werkzeug-Set für Klempner
PL Wkład do szuflady / Zestaw narzędziowy dla hydraulików
RUS Вклад к выдвижному ящику / Набор инструментов для водопроводчик
CZ Vložka do zásuvky / Sada nářadí pro instalatér
H Fiókbetét / Szerszámkészlet vízvezeték-szerelő
RO Adaos la sertar / Set de instrumente pt. instalator
F Module plastique pour servante / Un ensemble d'outils pour les plombier
I Tenone per l'armadio / Tool set per idraulici
E Accesorio de cajón / Un conjunto de herramientas para fontanero
CN 水管工具组套

5
PCS

CrV

CrMo

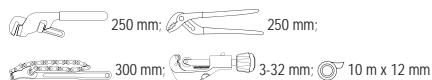

YATO
YT-55481 5

- GB Drawer insert / Tool set for plumbers
D Schubladeneinlage / Werkzeug-Set für Klempner
PL Wkład do szuflady / Zestaw narzędziowy dla hydraulików
RUS Вклад к выдвижному ящику / Набор инструментов для водопроводчик
CZ Vložka do zásuvky / Sada nářadí pro instalatér
H Fiókbetét / Szerszámkészlet vízvezeték-szerelő
RO Adaos la sertar / Set de instrumente pt. instalator
F Module plastique pour servante / Un ensemble d'outils pour les plombier
I Tenone per l'armadio / Tool set per idraulici
E Accesorio de cajón / Un conjunto de herramientas para fontanero
CN 水管工具组套

5
PCS

HSS

8CrB

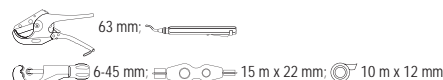

YATO
YT-55482 5

- GB** Drawer insert / Pliers and adjustable wrenches
D Schubladeneinlage / Zangen und rollgabelschlüssel
PL Wkład do szuflady / Szczypce i klucze nastawne
RUS Вклад к выдвижному ящику / Клещи и ключ разводной
CZ Vložka do zásuvky / Kleště, nastavitelný klíč
H Fiókbetét / Fogók és állítható svédkulcs
RO Adaos la sertar / Clește și cheie reglabilă
F Module plastique pour servante / Pincés et clé a molette
I Tenone per l'armadio / Pinze
E Accesorio de cajón / Pinzas y llave ajustable
CN 活络扳手大力钳托盘组套

PLASTIC TRAY & COLOR LABEL



4
PCS

CrMo

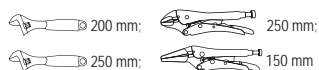

YATO
YT-55444 8

- GB** Drawer insert / Pliers
D Schubladeneinlage / Zangen
PL Wkład do szuflady / Szczypce
RUS Вклад к выдвижному ящику / Клещи
CZ Vložka do zásuvky / Kleště
H Fiókbetét / Fogók
RO Adaos la sertar / Clește
F Module plastique pour servante avec pincés
I Tenone per l'armadio / Pinze
E Accesorio de cajón / Pinzas
CN 钳子托盘组套

PLASTIC TRAY & COLOR LABEL



4
PCS

CrV

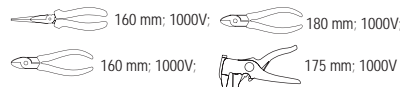

YATO
YT-55464 8

- GB** Drawer insert / Slotted screwdrivers
D Schubladeneinlage / Flachschauber
PL Wkład do szuflady / Wkrętki płaskie
RUS Вклад к выдвижному ящику / Плоские отвертки
CZ Vložka do zásuvky / Šroubováky ploché
H Fiókbetét / Lapos csavarhúzó
RO Adaos la sertar / Șurubelnițe plane
F Module plastique pour servante avec tournevis
I Tenone per l'armadio / Set di cacciaviti piatti
E Accesorio de cajón / Desarmadores planos
CN 一字螺丝批托盘组套

PLASTIC TRAY & COLOR LABEL



7
PCS

CrMo

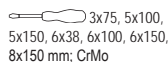
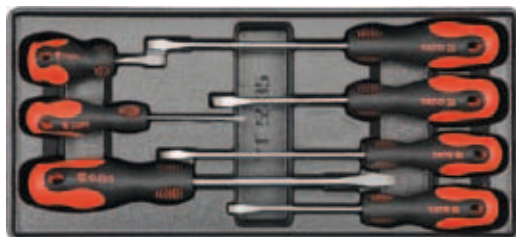

YATO
YT-5535 8

- GB** Drawer insert / Phillips screwdrivers
D Schubladeneinlage / Kreuzschlitzschrauber
PL Wkład do szuflady / Wkrętki krzyżakowe
RUS Вклад к выдвижному ящику / Крестовидные отвертки
CZ Vložka do zásuvky / Šroubováky křížové
H Fiókbetét / Kereszt csavarhúzó
RO Adaos la sertar / Șurubelnițe în cruce
F Module plastique pour servante avec tournevis
I Tenone per l'armadio / Set di cacciaviti a croce
E Accesorio de cajón / Desarmadores de cruz
CN 十字螺丝批托盘组套

PLASTIC TRAY & COLOR LABEL



7
PCS

CrMo

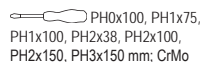
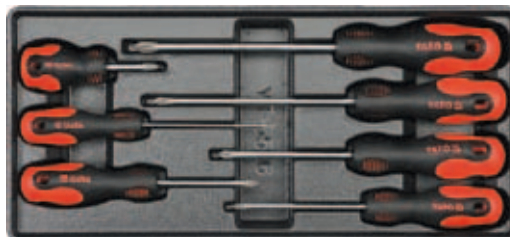

YATO
YT-5536 8

16

- GB** Drawer insert / Screwdriver set
D Schubladeneinlage / Schraubendrehersatz
PL Wkład do szuflady / Komplet wkrętek
RUS Вклад к выдвижному ящику / Набор отверток
CZ Vložka do zásuvky / Zámečnické šroubováky
H Fiókbetét / Csavarhúzó készlet
RO Adaos la sertar / Șurubelnițe de lăcătușerie
F Module plastique pour servante avec tournevis
I Tenone per l'armadio / Set di cacciaviti
E Accesorio de cajón / Juego de destornilladores
CN 螺丝批托盘组套

PLASTIC TRAY & COLOR LABEL



13
PCS

S2

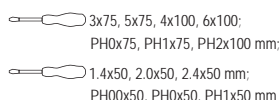

YATO
YT-55455 8

- GB** Drawer insert / Go-through screwdrivers
D Schubladeneinlage / Schlagschrauber
PL Wkład do szuflady / Wkrętki do pobijania
RUS Вклад к выдвижному ящику / Отвертка-било
CZ Vložka do zásuvky / Šroubovák s úderným koncem
H Fiókbetét / Üthető csavarhúzó
RO Adaos la sertar / Șurubelniță pt. fixare
F Module plastique pour servante / Allez - par tournevis
I Tenone per l'armadio / Set di cacciaviti
E Accesorio de cajón / Destornillador para dar golpes
CN 穿心螺丝批托盘组套

PLASTIC TRAY & COLOR LABEL



4
PCS

CrV



YATO
YT-55469 8

- GB** Drawer insert / Screwdriver set
D Schubladeneinlage / Schraubendrehersatz
PL Wkład do szuflady / Komplet wkrętek
RUS Вклад к выдвижному ящику / Набор отвёрток
CZ Vložka do zásuvky / Zámečnické šroubováky
H Fiókbetét / Szigetelt csavarhúzó
RO Adaos la sertar / Şurubelnițe de lăcătuşerie
F Module plastique pour servante avec trounevis
I Tenone per l'armadio / Set di cacciaviti
E Accesorio de cajón / Juego de destornilladores
CN 绝缘螺丝批托盘组套

PLASTIC TRAY & COLOR LABEL

8
PCS

S2



- 3x75, 4x100, 5.5x125, 6.5x150,
PH1x80, PH2x100, PH3x150 mm; 1000V;
4x190 mm; 250V

YATO

YT-55462

8

- GB** Drawer insert / Tool set
D Schubladeneinlage / Sechskant-Steckschlüssel-Satz
PL Wkład do szuflady / Zestaw narzędziowy
RUS Вклад к выдвижному ящику / Набор инструмента
CZ Vložka do zásuvky / Sada nástrčných kľúčů a ráčny
H Fiókbetét / Dugókulcs készlet racsnis hajtókarral
RO Adaos la sertar / Rotruşa chei tubulare cu antrenor
F Module plastique pour servante / Coffret d'outillage
I Tenone per l'armadio / Set di utensili
E Accesorio de cajón / Juego de herramientas
CN 套筒扳手组套

PLASTIC TRAY & COLOR LABEL

4
PCS

CrV



- 3/4" (19.0 mm); (200 mm); CrV 6140;
3/4" (19.0 mm); CrV 50BV30;
3/4" (19.0 mm); (500 mm); 72T; CrV 6140;
3/4" (19.0 mm); (500 mm); CrV 50BV30

YATO

YT-55458

4

- GB** Drawer insert / Socket set
D Schubladeneinlage / Steckschlüsselsatz
PL Wkład do szuflady / Zestaw kluczy nasadowych
RUS Вклад к выдвижному ящику / Торцовые ключи
CZ Vložka do zásuvky / Kľiče nástrčné
H Fiókbetét / Dugókulcsok
RO Adaos la sertar / Duză cheie
F Module plastique pour servante avec set d'outillages
I Tenone per l'armadio chiave a bussola
E Accesorio de cajón / Llaves de cubo
CN 套筒托盘组套

PLASTIC TRAY & COLOR LABEL

22
PCS

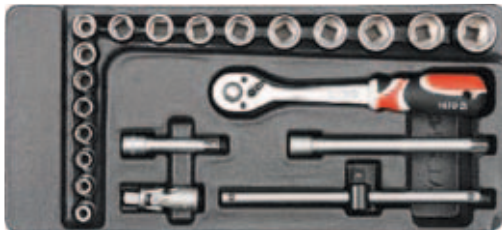

- 3/8" (9.5 mm): 6, 7, 8, 9, 10, 11, 12, 13, 14,
15, 16, 17, 18, 19, 20, 21, 22 mm; CrV 50BV30;
3/8" (9.5 mm): (76, 152.4 mm); CrV 50BV30;
3/8" (9.5 mm); CrV 50BV30;
3/8" (9.5 mm); (200 mm); 72T; CrV 6140;
3/8" (9.5 mm); (198 mm); CrV 50BV30

YATO

YT-5542

8

- GB** Drawer insert / Socket set
D Schubladeneinlage / Steckschlüsselsatz
PL Wkład do szuflady / Zestaw kluczy nasadowych
RUS Вклад к выдвижному ящику / Торцовые ключи
CZ Vložka do zásuvky / Kľiče nástrčné
H Fiókbetét / Dugókulcsok
RO Adaos la sertar / Duză cheie
F Module plastique pour servante avec set d'outillages
I Tenone per l'armadio chiave a bussola
E Accesorio de cajón / Llaves de cubo
CN 套筒托盘组套

PLASTIC TRAY & COLOR LABEL

25
PCS

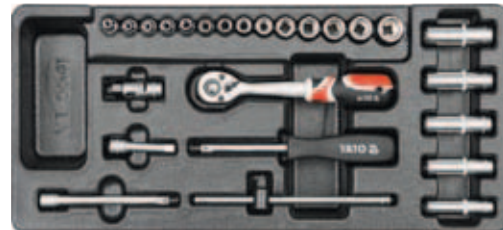

- 1/4" (6.3 mm): 3.5, 4, 4.5, 5, 5.5, 6, 7, 8, 9, 10, 11, 12, 13, 14
mm; CrV 50BV30; 1/4" (6.3 mm): 8, 10, 11, 12, 13 mm; CrV
50BV30; 1/4" (6.3 mm): (50.8, 101.6 mm); CrV 6140;
1/4" (6.3 mm); CrV 50BV30; 1/4" (6.3 mm): (155 mm);
72T; CrV 6140; 1/4" (6.3 mm): (152.4 mm); CrV
50BV30

YATO

YT-5541

8

- GB** Drawer insert / Socket set
D Schubladeneinlage / Steckschlüsselsatz
PL Wkład do szuflady / Zestaw kluczy nasadowych
RUS Вклад к выдвижному ящику / Торцовые ключи
CZ Vložka do zásuvky / Kľiče nástrčné
H Fiókbetét / Dugókulcsok
RO Adaos la sertar / Duză cheie
F Module plastique pour servante avec set d'outillages
I Tenone per l'armadio chiave a bussola
E Accesorio de cajón / Llaves de cubo
CN 套筒托盘组套

PLASTIC TRAY & COLOR LABEL

24
PCS

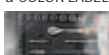

- 1/2" (12.7 mm): 10, 11, 12, 13, 14, 15, 16,
17, 18, 19, 20, 21, 22, 23, 24,
27, 30, 32 mm; CrV 50BV30;
1/2" (12.7 mm); (127 mm); CrV 50BV30;
1/2" (12.7 mm); CrV 50BV30;
1/2" (12.7 mm); (255 mm); 72T; CrV 6140;
1/2" (12.7 mm); (255 mm); CrV 50BV30;
1/2" (12.7 mm): 16; 21 mm; CrV 50BV30

YATO

YT-5537

4

- GB** Drawer insert / Screwdriver bits
D Schubladeneinlage / Endstücke für Schraubenzieher
PL Wkład do szuflady / Końcówki śrubokrętowe
RUS Вклад к выдвижному ящику / Насадки для отвёрток
CZ Vložka do zásuvky / Šroubovací nástavce
H Fiókbetét / Csavarhúzó bitek
RO Adaos la sertar / Terminații pt. şurubelnițe
F Module plastique pour servante avec set d'embouts
I Tenone per l'armadio chiave punti di avvitamento
E Accesorio de cajón / Puntas para desarmadores
CN 旋具头托盘组套

PLASTIC TRAY & COLOR LABEL

40
PCS

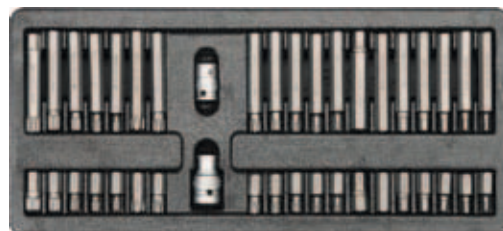

- H4, H5, H6, H7, H8, H10, H12 (L=30 mm); H4, H5, H6, H7,
H8, H10, H12 (L=75 mm); AISI S2; M5, M6, M8, M10, M12
(L=30 mm); M5, M6, M8, M10, M12 (L=75 mm); AISI S2; T20,
T25, T30, T40, T45, T50, T55 (L=30 mm); T20, T25, T30, T40,
T45, T50, T55 (L=75 mm); AISI S2; 1/2" (12.7 mm), 3/8" (9.5 mm)

YATO

YT-5538

8

- GB** Drawer insert / Socket set
D Schubladeneinlage / Steckschlüsselsatz
PL Wkład do szuflady / Zestaw kluczy nasadowych
RUS Вклад к выдвижному ящику / Торцовые ключи
CZ Vložka do zásuvky / Klíče nástrčné
H Fiókbetét / Dugókulcs készlet
RO Adaos la sertar / Duză cheie
F Module plastique pour servante avec set d'outillages
I Tenone per l'armadio chiave a bussola
E Accesorio de cajón / Llaves de cubo
CN 套筒托盘组套

PLASTIC TRAY & COLOR LABEL

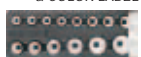

14 PCS

CrV 50BV30



3/4" (19.0 mm): 19, 21, 22, 24, 27, 28, 30, 32, 34, 36, 41, 46, 50, 55 mm

YATO
YT-55457 4

- GB** Drawer insert / Deep sockets
D Schubladeneinlage / Tiefe Steckschlüssel
PL Wkład do szuflady / Klucze nasadowe długie
RUS Вклад к выдвижному ящику / Торцовые глубокие ключи
CZ Vložka do zásuvky / Klíče nástrčné hluboké
H Fiókbetét / Hosszú dugókulcsok
RO Adaos la sertar / Prize de curent adânci
F Module plastique pour servante avec set de douilles
I Tenone per l'armadio chiave a bussola lunghe
E Accesorio de cajón / Llaves de cubo profundo
CN 六角长套筒托盘组套

PLASTIC TRAY & COLOR LABEL



14 PCS

CrV 50BV30



1/2" (12.7 mm): 8, 9, 10, 11, 12, 13, 14, 15, 16, 17, 18, 19, 20, 21 mm (L=76 mm); CrV 50BV30

YATO
YT-5539 8

- GB** Drawer insert / Tool set
D Schubladeneinlage / Sechskant-Steckschlüssel-Satz
PL Wkład do szuflady / Zestaw narzędziowy
RUS Вклад к выдвижному ящику / Набор инструмента
CZ Vložka do zásuvky / Sada nástrčných klíčů a ráčny
H Fiókbetét / Dugókulcs készlet
RO Adaos la sertar / Rotrusa chei tubulare cu antrenor
F Module plastique pour servante / Coffret d'outillage
I Tenone per l'armadio / Set di utensili
E Accesorio de cajón / Juego de herramientas
CN 套筒扳手组套

PLASTIC TRAY & COLOR LABEL

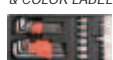

31 PCS

CrV

S2

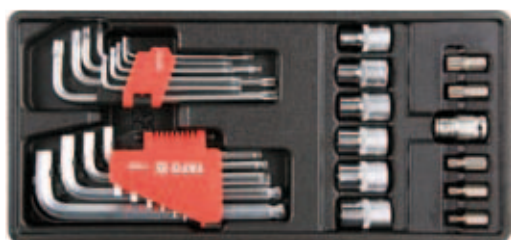

1/2" (12.7 mm): E10, E12, E14, E16, E18, E20 (L=38 mm); CrV 50BV30;
 M5, M6, M8, M10, M12 (L=30 mm); AISI S2;
 1/2" (12.7 mm): 10 mm; CrV 6150;
 2, 2.5, 3, 4, 5, 6, 7, 8, 10, 12 mm; CrV 6150;
 T10, T15, T20, T25, T27, T30, T40, T45, T50; CrV 6150

YATO
YT-55451 8

- GB** Drawer insert / Hammers and chisels
D Schubladeneinlage / Hämmer und Meißel
PL Wkład do szuflady / Młotki i przecinaki
RUS Вклад к выдвижному ящику / Молотки и зубила
CZ Vložka do zásuvky / Kladiva, dláta a sekáče
H Fiókbetét / Kalapácsok és hidegvágók
RO Adaos la sertar / Ciocane și dălți
F Module plastique pour servante avec marteaux et burins
I Tenone per l'armadio martelli e scalpelli
E Accesorio de cajón / Martillos y cinceles
CN 锤头凿子托盘组套

PLASTIC TRAY & COLOR LABEL



5 PCS

CrV



300 g (L=300 mm);
 40 mm (L=350 mm);
 10x8x142 mm,
 12x10x152 mm, 16x13x172 mm

YATO
YT-5540 8

16

- GB** Drawer insert / Measuring tools
D Schubladeneinlage / Messwerkzeuge
PL Wkład do szuflady / Narzędzia miernicze
RUS Вклад к выдвижному ящику / Измерительные приборы
CZ Vložka do zásuvky / Měřeni
H Fiókbetét / Mérészközök
RO Adaos la sertar / Instrumente de măsură
F Module plastique pour servante / Outils de mesurage
I Tenone per l'armadio / Strumenti di misura
E Accesorio de cajón / Instrumentos de medición
CN 量具托盘组套

PLASTIC TRAY & COLOR LABEL



5 PCS



300 mm; 0-150 mm;
 2 m;
 3m x 16 mm; 0.02-1.00 mm

YATO
YT-55474 8

- GB** Drawer insert / Steel file set
D Schubladeneinlage / Werkstatt-feilen
PL Wkład do szuflady / Pilniki do metalu
RUS Вклад к выдвижному ящику / Набор напильников слесарных
CZ Vložka do zásuvky / Zámečnické pilníky
H Fiókbetét / Lakatos reszelő
RO Adaos la sertar / Pile de lăcătușerie
F Module plastique pour servante / Fichier steel ensemble
I Tenone per l'armadio / File di metallo
E Accesorio de cajón / Juego de limas para metal
CN 锉刀托盘组套

PLASTIC TRAY & COLOR LABEL



5 PCS

T12 STEEL



#2 200 mm;
 #2 200 mm;
 #2 200 mm;
 #2 200 mm;
 #2 200 mm

YATO
YT-55453 8

- GB Drawer insert / Hand riveter with rivets
D Schubladeneinlage / Blindnietzange
PL Wkład do szuflady / Nitownica ręczna z głowicą obrotową
RUS Вклад к выдвижному ящику / Запечочник
CZ Vložka do zásuvky / Ruční nýtovačka
H Fiókbetét / Kézi popzegecsűző
RO Adaos la sertar / Pclește pt. popnituri
F Module plastique pour servante / Riveteuse a main
I Tenone per l'armadio / Rivettatrice manuale girevole
E Accesorio de cajón / Remachadora de mano
CN 手动铆钉枪及铆钉托盘组套

PLASTIC TRAY & COLOR LABEL



6
PCS

CrMo



2.4, 3.2, 4.0, 4.8 mm;
9.6x3.2, 9.6x4.0, 12.7x4.0, 9.6x4.8, 12.7x4.8 mm

YATO
YT-55466 8

- GB Drawer insert / Tool set
D Schubladeneinlage / Sechskant-Steckschlüssel-Satz
PL Wkład do szuflady / Zestaw narzędziowy
RUS Вклад к выдвижному ящику / Набор инструмента
CZ Vložka do zásuvky / Sada nástrčných klíčů a ráčny
H Fiókbetét / Dugókulcs készlet racsnis hajtókarral
RO Adaos la sertar / Rotrusa chei tubulare cu antrenor
F Module plastique pour servante / Coffret d'outillage
I Tenone per l'armadio / Set di utensili
E Accesorio de cajón / Juego de herramientas
CN 套筒扳手组套

PLASTIC TRAY & COLOR LABEL



6
PCS

CrMo

CrV



1*(25 mm), L=330 mm;
250 mm;
2.4, 3.2, 4.0, 4.8 mm;
9.6x3.2, 9.6x4.0, 12.7x4.8 mm

YATO
YT-55478 8

- GB Drawer insert / Automotive workshop tools
D Schubladeneinlage / Kfz-werkzeuge
PL Wkład do szuflady / Zestaw narzędzi warsztatowych
RUS Вклад к выдвижному ящику / Автомобильные инструменты
CZ Vložka do zásuvky / Auto nářadí
H Fiókbetét / Autóipari szerszámok
RO Adaos la sertar / Scule auto
F Module plastique pour servante / Outils de réparation automobile
I Tenone per l'armadio / Set attrezzi officina
E Accesorio de cajón / Herramientas de automoción
CN 轮胎修理工具托盘组套

PLASTIC TRAY & COLOR LABEL



5
PCS

CrV



200 mm; 135 mm;
300, 400, 500 mm

YATO
YT-55477 4

- GB Drawer insert / Automotive workshop tools
D Schubladeneinlage / Kfz-werkzeuge
PL Wkład do szuflady / Zestaw narzędzi warsztatowych
RUS Вклад к выдвижному ящику / Автомобильные инструменты
CZ Vložka do zásuvky / Auto nářadí
H Fiókbetét / Autóipari szerszámok
RO Adaos la sertar / Scule auto
F Module plastique pour servante / Outils de réparation automobile
I Tenone per l'armadio / Set attrezzi officina
E Accesorio de cajón / Herramientas de automoción
CN 轮胎修理工具托盘组套

PLASTIC TRAY & COLOR LABEL



10
PCS

CrV



1/2" (12.7 mm) x 5/16" (7.9 mm);
PH3 (L=35 mm); PH1, PH2, PH3 (L=75 mm);
8 mm (L=35 mm); 8 mm (L=75 mm);
12-38 mm; 3" (75 mm); 82 mm

YATO
YT-55476 4

- GB Drawer insert / Tool set
D Schubladeneinlage / Sechskant-Steckschlüssel-Satz
PL Wkład do szuflady / Zestaw narzędziowy
RUS Вклад к выдвижному ящику / Набор инструмента
CZ Vložka do zásuvky / Sada nástrčných klíčů a ráčny
H Fiókbetét / Dugókulcs készlet racsnis hajtókarral
RO Adaos la sertar / Rotrusa chei tubulare cu antrenor
F Module plastique pour servante / Coffret d'outillage
I Tenone per l'armadio / Set di utensili
E Accesorio de cajón / Juego de herramientas
CN 套筒扳手组套

PLASTIC TRAY & COLOR LABEL

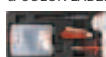

23
PCS



140 mm; 200 mm;
19 mm x 20 mm; 4x190 mm; 250 V;
1.0, 1.5, 2.0, 2.5, 3.0, 3.5, 4.0, 4.5, 5.0, 5.5,
6.0, 6.5, 7.0, 7.5, 8.0, 8.5, 9.0, 9.5, 10.0 mm

YATO
YT-55471 8

- GB Drawer insert / Taps and die set
D Schubladeneinlage / Gewindeschneidwerkzeug-satz
PL Wkład do szuflady / Zestaw narzynek i gwintowników
RUS Вклад к выдвижному ящику / Набор плашек и метчиков
CZ Vložka do zásuvky / Souprava závitníků a kruhových závitových čelistí
H Fiókbetét / Menetfűró és menetvágó készlet
RO Adaos la sertar / Set de tarozi și filiere
F Module plastique pour servante / Pince a riveter avec embouts
I Tenone per l'armadio / Set di filiera a maschi
E Accesorio de cajón / Juego de machos de roscar y cojinetes
CN 丝锥板牙托盘组套

PLASTIC TRAY & COLOR LABEL



35
PCS

HCS

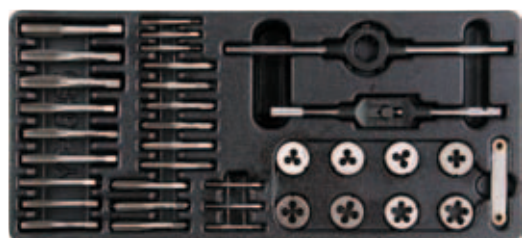

3x: M3x0.5, M4x0.7, M5x0.8, M6x1.0, M7x1.0, M8x1.25,
M10x1.5, M12x1.75; M3x0.5, M4x0.7, M5x0.8, M6x1.0, M7x1.0, M8x1.25,
M10x1.5, M12x1.75; 0.5 - 1.75 mm; 27G; 28G;
M7-M9; M3-M12

YATO
YT-55465 8

- GB Drawer insert
- D Schubladeneinlage
- PL Wkład do szuflady
- RUS Вклад к выдвижному ящику
- CZ Vložka do zásuvky
- H Fiókbetét
- RO Adaos la sertar
- F Module plastique pour servante
- I Tenone per l'armadio
- E Accesorio de cajón
- CN 吸塑盒



for / dla: YT-5531

YATO	5/30
YT-55311	5/30



for / dla: YT-5532

YATO	5/30
YT-55321	5/30



for / dla: YT-5533

YATO	5/30
YT-55331	5/30

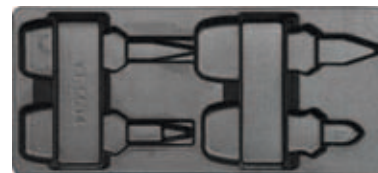

for / dla: YT-5534

YATO	5/30
YT-55341	5/30

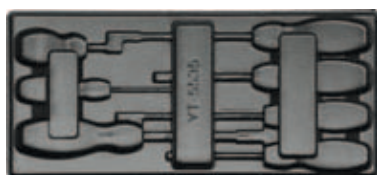

for / dla: YT-5535

YATO	5/30
YT-55351	5/30

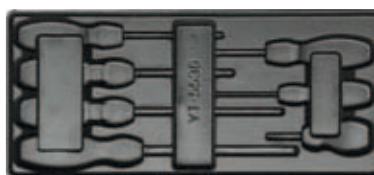

for / dla: YT-5536

YATO	5/30
YT-55361	5/30



for / dla: YT-5537

YATO	5/30
YT-55371	5/30



for / dla: YT-5538

YATO	5/30
YT-55381	5/30



for / dla: YT-5539

YATO	5/30
YT-55391	5/30



for / dla: YT-5540

YATO	5/30
YT-55401	5/30

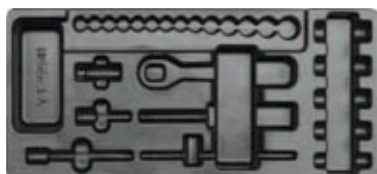

for / dla: YT-5541

YATO	5/30
YT-55411	5/30



for / dla: YT-5542

YATO	5/30
YT-55421	5/30



for / dla: YT-55454

YATO	5/30
YT-55479	5/30

16

- GB Legs for workbench, long
- D Beine für Werkbank, lange
- PL Nogi do stołu warsztatowego, długie
- RUS Ножки для верстака, длинные
- CZ Nohy k pracovnímu stolu, dlouhé
- H Lábak munkapadhoz
- RO Picioare pt. banc de lucru, lungi
- F Jambes pour table d'atelier
- I Gambe del tavolo piedi del banco da lavoro
- E Patas para banco de trabajo, largas
- CN 工作台长桌腿



2
PCS

140
cm

WHITE
CARTON BOX
& COLOR LABEL

for / dla: YT-08920

YATO	size / rozmiar (cm)	2
YT-08921	140	2

- GB Holders for workshop box
- D Halterungen für die Montage eines Werkstattschranks
- PL Uchwyty do montażu szafki warsztatowej
- RUS Крепеж для рабочего шкафа
- CZ Montážní držáky dílenské skříňky
- H Műhelyszekrény tartó
- RO Suporturi pt. montarea dulapului de atelier
- F Porte-placard d'atelier
- I Staffa di montaggio per armadio portautensili
- E Elementos de fijación para instalación de cajón de taller
- CN 工具柜安装挂板



2
PCS

500x100
x350 mm

WHITE
CARTON BOX
& COLOR LABEL

for / dla: YT-08920, YT-09152

YATO	size / rozmiar (mm)	2
YT-08922	500x100x350	2

- GB Connection steel pipes set
D Anschluss Stahlrohre Gesetzt
PL Rury montażowe
RUS Стальная труба монтаж
CZ Ocelové trubky
H Acélcsővek
RO Tevi din oțel
F Tuyaux en acier
I Set di montaggio per tabella utensili
E Tubos de acero
CN 工具柜连接杆





POLYBAG

2
PCS

48.5
x Ø2.8 cm

for / dla:
YT-09152
YT-09155
+
YT-0902
YT-0903
YT-0904



YATO 	size / rozmiar (cm)	
YT-09071	48.5 x Ø 2.8	20

- GB Double project center backwall
D Werkzeugwand
PL Tablica narzędziowa
RUS Доска инструмент
CZ Držáky na nářadí
H Szerszámartató fal akasztókkal
RO Suport perete scule
F Mur d'outil
I La tabella utensili
E Panel de herramientas
CN 工具车双挂板



POLYBAG

2
PCS

65.2 x 61
x 5.5 cm





for / dla:
YT-0902 YT-55290
YT-0903 YT-55292
YT-09031 YT-55293
YT-0904 YT-5530

YATO 	size / rozmiar (cm)	
YT-09072	65.2x61x5.5	2

- GB Compartmented shelf and paper roll holder
D Werkstattwagenablage mit Papierrollehalter
PL Półka z uchwytem na papier
RUS Полка с держателем для бумаги
CZ Police s úchytem na papír
H Kiegészítő polc és papírolni tartó funkcióval
RO Compartiment pt. dulap si suport hartie
F Support rouleau papier
I Mensola portarotoli carta
E Estante con sujetapapel
CN 托架





for / dla: YT-0902, YT-0903, YT-0904, YT-0905

YATO 	size / rozmiar (mm)	
YT-0907	305x305x145	4

- GB Dustbin
D Abfalleimer
PL Pojemnik na odpady
RUS Мусорный ящик
CZ Zásobník na odpad
H Szemetkosár
RO Lada de gunoi
F Poubelle
I Contenitore di rifiuti
E Cubo de basura
CN 废品箱





for / dla: YT-0902, YT-0903, YT-0904, YT-0905

YATO 	size / rozmiar (mm)	
YT-0908	300x300x190	4

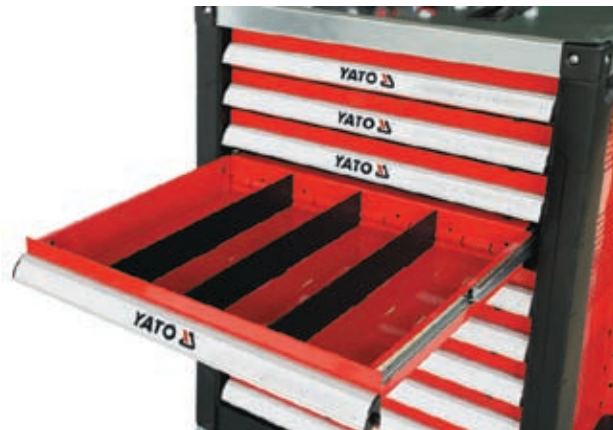
- GB Separate board for drawer
D Trennsteg für Werkstatt-Wagen-Schublade
PL Przegroda do szafki
RUS Перегородки для ящика
CZ Příhradka do police
H Több rekeszes tálcá
RO Sertar separat de masura mica
F Cloison tiroir court
I Separatore per armadio
E Separador para armario
CN 抽屉分隔板



for / dla: YT-0902, YT-0903, YT-0904, YT-0905

YATO 	size / rozmiar (mm)	
YT-0910	391x58x4	24
YT-0911	391x128x4	24



GB Tool box
D Werkzeugkasten
PL Skrzynka narzędziowa
RUS Инструментальный ящик
CZ Skříňka na nářadí
H Szerszámos láda

RO Cutie de scule
F Boîte à outils
I Cassetta degli attrezzi
E Caja de herramientas
CN 工具箱

WHITE
CARTON BOX
& COLOR LABEL

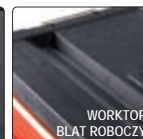

RUBBER CORNER
GUMOWY NAROŻNIK

WORKTOP
BLAT ROBOCZY







390x215x130 mm
max 10 kg



390x215x60 mm
max 5 kg

390x215x60 mm
max 5 kg

YATO 	drawers / szuflady	
YT-09108	1	2

YATO 	drawers / szuflady	
YT-09107	2	2

GB Tool trolley
D Werkzeugkasten
PL Wózek narzędziowy 3-częściowy
RUS Тележка инструментальная
CZ Vozík na nářadí
H Szerszám kocsi
RO Instrument cărucior
F Servante d'atelier
I Armadio per utensili
E Herramienta carro
CN 工具箱



WHITE
CARTON BOX
& COLOR LABEL

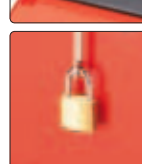
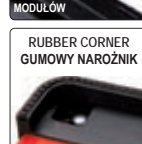
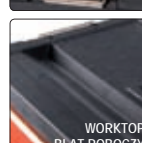

WORKTOP
BLAT ROBOCZY

MODULES
PROTECTION

ZABEZPIECZENIE
MODUŁÓW

RUBBER CORNER
GUMOWY NAROŻNIK



420x220x150 mm
max 20 kg

390x215x130 mm
max 10 kg

410x210x280 mm
max 15 kg

420x220x150 mm
max 20 kg

390x215x60 mm
max 5 kg

390x215x60 mm
max 5 kg

410x210x280 mm
max 15 kg



YATO 		
YT-09102		1



YATO 		
YT-09101		1

- GB Cantilever tool box
D Werkzeugkoffer
PL Skrzynka narzędziowa
RUS Инструментальный ящик
CZ Nástrojová skříňka
H Szerszámosláda
- RO Cutie pt. scule
F Boîte à outils
I Cassetta degli attrezzi
E Caja de herramientas
CN 工具箱



WHITE
CARTON
BOX
& COLOR
LABEL





YATO 	size / rozmiar (mm)	
YT-0882	360x150x115	4



YATO 	size / rozmiar (mm)	
YT-0883	428x180x180	1



YATO 	size / rozmiar (mm)	
YT-0884	460x200x180	1

YATO 	size / rozmiar (mm)	
YT-0885	460x200x225	1



YATO 	size / rozmiar (mm)	
YT-0886	510x220x240	1

GB Tool box with tools
 D Werkzeugkoffer
 PL Skrzynka z narzędziami
 RUS Инструментальный ящик
 CZ Nástrojová skříňka
 H Szerszámoszláda
 RO Cutie pt. scule
 F Boîte d'outils
 I Cassetta degli attrezzi
 E Caja de herramientas
 CN 工具组套



62 PCS	1/2" 12.5mm	CrV 50BV30	CrV 6150	CrV 6140
72T	AS-DRIVE	⊖	⊕	

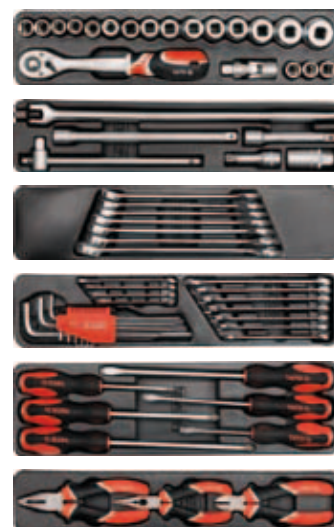

- 1/2" (12.7 mm): 10, 11, 12, 13, 14, 15, 16, 17, 18, 19, 20, 21, 22, 23, 24 mm (L=38 mm); 27, 30, 32 mm (L=42 mm); CrV 50BV30;
- 1/2" (12.7 mm): (76, 127, 254 mm); CrV 50BV30;
- 1/2" (12.7 mm); CrV 50BV30;
- 1/2" (12.7 mm): 21 mm; CrV 50BV30;
- 1/2" (12.7 mm); (255 mm); CrV 50BV30;
- 1/2" (12.7 mm); 72T; CrV 6140;
- 1/2" (12.7 mm); (450 mm); CrV 50BV30;
- 6, 7, 8, 9, 10, 11, 12, 13, 14, 15, 16, 17, 18, 19, 20, 21, 22, 24 mm; CrV;
- 6x100, 6x150, 8x200 mm; CrV 6150;
- PH2x100, PH3x150, PH3x200 mm; CrV 6150;
- 180 mm; CrV; 160 mm; CrV; 160 mm; CrV;
- 1.5, 2, 2.5, 3, 4, 5, 6, 8, 10 mm; CrV 6150



YATO	size / rozmiar (mm)	
YT-3895	475x230x365	1

GB Tool box with tools
 D Werkzeugkoffer
 PL Skrzynka z narzędziami
 RUS Инструментальный ящик
 CZ Nástrojová skříňka
 H Szerszámoszláda
 RO Cutie pt. scule
 F Boîte d'outils
 I Cassetta degli attrezzi
 E Caja de herramientas
 CN 工具组套

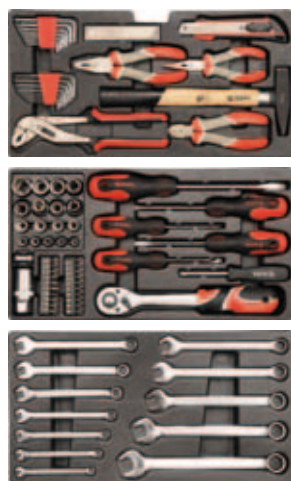

80 PCS	1/2" 12.5mm	1/4" 6.3mm	CrV 50BV30	CrV 6140
S2	72T	AS-DRIVE	⊖	⊕



- 1/2" (12.7 mm): 10, 11, 12, 13, 14, 15, 17, 19 mm (L=38 mm); 1/4" (6.3 mm): 5, 6, 7, 8, 9, 10, 11, 12, 13 mm (L=25 mm); CrV 50BV30;
- 1/2" (12.7 mm): 21 mm; CrV 50BV30;
- 1/2" (12.7 mm); (255 mm); 72T; CrV 6140;
- 1/4" (6.3 mm); (150 mm); CrV 50BV30;
- 1/4" (6.3 mm) x 1/4" (6.3 mm); CrV 50BV30;
- 1/4" (6.3 mm): 3 (x2), 4 (x2), 5 (x2), 5.5 (x2), 6 (x2) mm (L=25 mm); AISI S2;
- 1/4" (6.3 mm): PH0, PH1 (x2), PH2 (x2), PH3 (L=25 mm); AISI S2;
- 1/4" (6.3 mm): PZ0, PZ1 (x2), PZ2 (L=25 mm); AISI S2;
- 6, 7, 8, 9, 10, 11, 12, 13, 14, 15, 17, 19 mm; CrV;
- 5x75 mm, 6x100 mm, 8x150 mm, PH1x75 mm, PH2x100 mm; S2;
- 180 mm; CrV; 160 mm; CrV; 160 mm; CrV;
- 250 mm; 300 g; 18 mm; SK2; 18x0.5 mm; SK2;
- 1.5, 2, 2.5, 3, 4, 5, 5.5, 6 mm; T10, T15, T20, T25, T27, T30, T40; CrV



YATO	size / rozmiar (mm)	
YT-38951	460x220x245	1

- GB Oil filter wrench
- D Ölfilterschlüssel
- PL Klucz do filtra oleju
- RUS Ключ к масляному фильтру
- CZ Klíč na olejový filtr
- H Olajszűrő kulcs
- RO Cheie pt. filtru de ulei
- F Clé au filtre d'huile
- I Chiave per filtro olio
- E Llave para el filtro de aceite
- CN 滤清器扳手

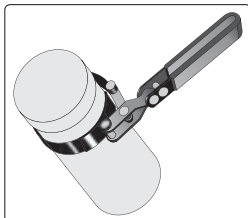
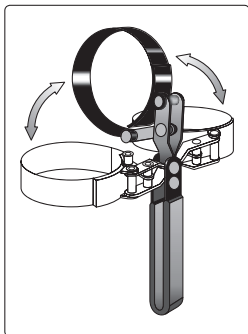

SLIDING CARD



YATO	Ø (mm)	
YT-0820	60-73	12/48
YT-0821	73-85	12/48
YT-0822	85-95	12/48
YT-0823	95-111	12/48

- GB Belt oil wrench
- D Ölfilterschlüssel mit Riemen
- PL Klucz taśmowy do filtrów oleju
- RUS Ключ тросовый для масляных фильтров
- CZ Klíč na olejové filtry
- H Olajszűrő kulcs
- RO Cheie filtru cu banda
- F Clé au filtre d'huile
- I Chiave a nastro per filtro olio
- E Llave de cinta para filtros de aceite
- CN 皮带钳扳手



BLISTER CARD



YATO	Ø (mm)	
YT-0824	80-160	6/60
YT-0825	100-200	5/20

- GB Oil filter wrench
- D Ölfilterschlüssel
- PL Klucz do filtra oleju
- RUS Съёмник масляных фильтров
- CZ Klíč na filtr oleju řetezový
- H Olajszűrő kulcs, láncos
- RO Cheie filtru ulei cu lanț
- F Clé au filtre d'huile
- I Chiave per filtro olio
- E Llave do filtro de cadenta
- CN 滤清器扳手



COLOR BOX



63-120 mm 2.5-4"	3/8" 10.0 mm	1/2" 12.5 mm
HRC 40-50	CrV	

YATO	
YT-0826	12/36

- GB Cap type oil filter wrench set
- D Steckschlüsselsatz für den Ölfilter
- PL Zestaw kluczy nasadowych do filtra oleju
- RUS Набор торцовых ключей к масляному фильтру
- CZ Sada miskovitých klíčů na olejové filtry
- H Dugókulcs készlet olajszűrőhöz
- RO Set de chei tubulare pt. filtru de ulei
- F Set d'embouts aux filtres d'huile
- I Set di chiavi filtro olio
- E Juego de llaves de tubo para el filtro de aceite
- CN 碗型滤清器扳手组套



15
PCS

FIBRE
REINFORCED
POLYMER

3/8"
10 mm

16

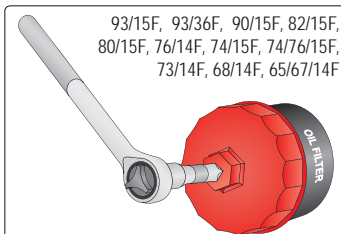

93/15F, 93/36F, 90/15F, 82/15F,
80/15F, 76/14F, 74/15F, 74/76/15F,
73/14F, 68/14F, 65/67/14F

BMC
& COLOR
SLEEVE



YATO	Ø	
YT-0595	3/8" (9.5 mm)	5

- GB Cap type oil filter wrench set
- D Steckschlüsselsatz für den Ölfilter
- PL Zestaw kluczy nasadowych do filtra oleju
- RUS Набор торцовых ключей к масляному фильтру
- CZ Sada miskovitých klíčů na olejové filtry
- H Dugókulcs készlet olajsűrőhöz

- RO Set de chei tubulare pt. filtru de ulei
- F Set d'embouts aux filtres d'huile
- I Set di chiavi filtro olio
- E Juego de llaves de tubo para el filtro de aceite
- CN 碗型滤清器扳手组套

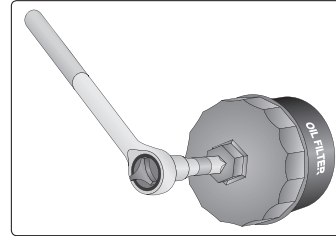

13
PCS

3/8"
10mm

1/2"
12.5mm

65-120
mm



YATO	number	size	layers	grooves	faces	car models
	number	rozmiar	warstwy	bruzdy	powierzchnie	modele samochodu
YT-0594	66/6	SW66	1	6		Fiat Punto 1.2, Renault Clio 1.2, Rapid, Twingo
	76/8	SW76	1	8		Fiat, Lancia
	76/12	SW76	1		12	Fiat, Mercedes, Renault
	86/16	SW86	1		16	Volvo
	86/18	SW86	1		18	VW Golf, Audi A6 TDI, Peugeot, Citroen
	92/10	SW92	1		10	Fiat
	93/45	SW93	1	45		VW, Audi TDI
	96/18	SW96	1	18		Audi A4, A6 TDI, VQ Passat TDI, Renault Laguna
	106/15	SW106	1		15	Fiat Ducato
	108/15	SW108	1		15	Volvo
	108/18	SW108	1	18		Renault Espace, Laguna, Safrane, Traffic

- GB Cap type oil filter wrench set
- D Steckschlüsselsatz für den Ölfilter
- PL Zestaw kluczy nasadowych do filtra oleju
- RUS Набор торцовых ключей к масляному фильтру
- CZ Sada miskovitých klíčů na olejové filtry
- H Dugókulcs készlet olajsűrőhöz

- RO Set de chei tubulare pt. filtru de ulei
- F Set d'embouts aux filtres d'huile
- I Set di chiavi filtro olio
- E Juego de llaves de tubo para el filtro de aceite
- CN 碗型滤清器扳手组套

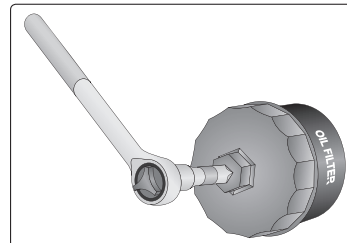

30
PCS

3/8"
10mm



YATO	number	size	layers	grooves	faces	car models
	number	rozmiar	warstwy	bruzdy	powierzchnie	modele samochodu
YT-0596	66/6	SW66	1	6		Fiat Punto 1.2, Renault Clio 1.2, Rapid, Twingo
	65/14	SW65	1		14	Daihatsu, Toyota, Nissan, Fiat
	65/67	SW65-67	1		14	Daihatsu, Toyota
	68/14	SW68	1		14	Mazda, Ford, Subaru
	73/14	SW73	1		14	Toyota, Lexus
	74/15	SW74	1		15	Audi, Rover, Chrysler
	74/76	SW74-76	2		15	Ford, Opel, VW, Audi, Mercedes
	75/77	SW75-77	2		15	VW, Audi, Isuzu, Mercedes
	76/12	SW76	1		12	Fiat, Mercedes, Renault
	76/14	SW76	1		14	VW, Porsche, Mercedes, BMW, Audi, Opel
	76/30	SW76	1	30		Ford
	76/8	SW76	1	8		Fiat, Lancia
	78/15	SW78	1		15	Nissan, Ford, Toyota
	80/15	SW80	1		15	Nissan, Honda, Opel, Mazda
	80/82	SW80-82	2		15	Subaru, Toyota, Honda, Nissan
	86/16	SW86	1		16	Volvo
	86/18	SW86	1		18	VW Golf, Audi A6 TDI, Peugeot, Citroen
	90/15	SW90	1		15	Honda, Mitsubishi, Isuzu
	92/10	SW92	1		10	Fiat
	93/15	SW93	1		15	Mazda, Volvo, Mitsubishi, Nissan, Honda
	93/36	SW93	1	36		Ford
	93/45	SW93	1	45		VW, Audi TDI
	95/15	SW95	1		15	Toyota, Alfa Romeo, Ford
	96/18	SW96	1	18		Audi A4, A6 TDI, VQ Passat TDI, Renault Laguna
	100/15	SW100	1		15	Isuzu, Mitsubishi
	106/15	SW106	1		15	Fiat Ducato
	108/15	SW108	1		15	Volvo
	108/18	SW108	1	18		Renault Espace, Laguna, Safrane, Traffic

- GB Oil filter sockets
D Aufsätze für die Ölfilter
PL Zestaw nasadek do filtrów oleju
RUS Набор насадок к масляным фильтрам
CZ Sada nástavců na olejové filtry
H Olajszűrő leszedő készlet
RO Set de cartușe pt. filtre de ulei
F Set d'embouts aux filtres d'huile
I Set di chiavi filtro olio
E Juego de tapones para los filtros de aceite
CN 滤油器套筒组套



4 PCS	3/8" 10mm	27 32 36 38 mm
CrV		AS-DRIVE
BMC & COLOR SLEEVE		



YATO		
YT-0598	3/8" (9.5 mm)	20

- GB Oil drain plug set
D Ölablassschrauben Schlüsselnsatz
PL Komplet kluczy do korków oleju
RUS Комплект ключей для сливной пробки
CZ Klíče nástrčné na zátky olejových van motorů
H Olajleeresztő kulcs készlet
RO Set bituri pt. bujon ulei
F Ensemble de clés de bouchon de vidange d'huile
I Set di chiavi a bussola
E Juego de llaves para tapones de aceite
CN 排油塞旋具组套

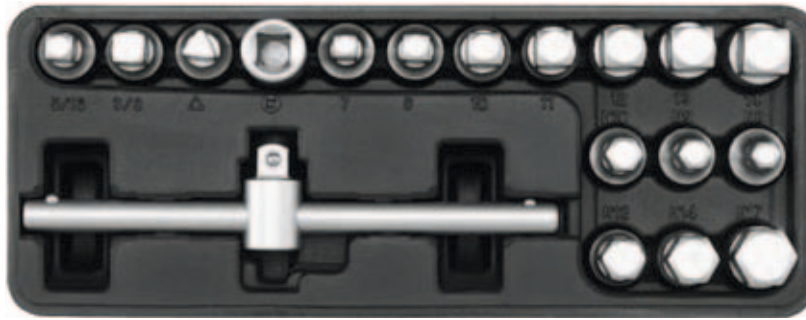

18 PCS	3/8" 10mm	7 8 10 11 12 13 14 mm
		8 9 10 12 14 17 mm
		CrV
BMC & COLOR SLEEVE		



YATO		
YT-0599	3/8" (9.5 mm)	10

- 7, 8, 10, 11, 12, 13, 14 mm; 8, 9, 10, 12, 14, 17 mm;
 5/16" (8 mm), 3/8" (10 mm); 10 mm; 10 mm; 160 mm

- GB Oil drain plug set
D Ölablassschrauben Schlüsselnsatz
PL Komplet kluczy do korków oleju
RUS Комплект ключей для сливной пробки
CZ Klíče nástrčné na zátky olejových van motorů
H Olajleeresztő kulcskészlet
RO Set bituri pt. bujon ulei
F Set de clés à vindage d'huile
I Set di chiavi per tappi olio
E Juego de llaves para tapones de aceite
CN 排油塞旋具组套



12 PCS	3/8" 10mm	(mm) 8 11 13
		(mm) 8 9 10 12 14 17

SLIDING CARD



YATO		
YT-0600		10/20

- GB Oil pan thread repair set
D Reparatursatz für Verschlussstopfen von Ölwanne
PL Zestaw naprawczy korków do miski olejowej
RUS Набор для ремонта масляных пробок
CZ Souprava na opravu vupouštěcích šroubů olejových van
H Olajteknő-csavar javítókészlet
RO Set pt. reparare dopuri baie de ulei
F Kit réparation de bouchons de carter d'huile
I Set per riparazione dei tappi della coppa del olio
E Juego de reparación para los tapones del cárter de aceite
CN 螺纹修复组套



64 PCS	CrMo
-----------	------

16

- | | | | | | |
|-------|-------|--------|-------|-------|--------|
| M13 | M13 | 13 mm | M17 | M17 | 17 mm |
| 5 pcs | 5 pcs | 10 pcs | 5 pcs | 5 pcs | 10 pcs |
| M15 | M15 | 15 mm | M20 | M20 | 20 mm |
| 5 pcs | 5 pcs | 10 pcs | 5 pcs | 5 pcs | 10 pcs |

BMC & COLOR SLEEVE



YATO		
YT-1757		5

GB Lever action grease gun with rigid spout
 D Handhebel-Fettpresse
 PL Smarownica ręczna z końcówką sztywną
 RUS Шприц для масляной смазки с твердым наконечником и гибким шлангом

CZ Páková maznice s pevnou koncovkou
 H Karos zsírzó
 RO Masina de gresat cu furtun rigid
 F Pistolet de graissage manuel

I Lubrificatore manuale
 E Pistola de engrase
 CN 手动黄油枪

COLOR BOX



P max.
70 MPa

P
31 MPa

AI



500 cm³

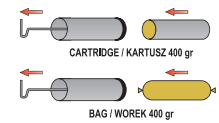

YATO	
YT-0700	20



120 cm³

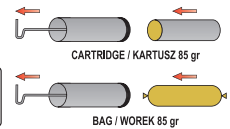

YATO	
YT-0701	30



400 cm³

YATO	
YT-0705	20

GB Grease gun
 D Handhebel-Fettpresse
 PL Smarownica ręczna
 RUS Шприц для масляной смазки
 CZ Páková maznice

H Karos zsírzó
 RO Masina de gresat cu furtun rigid
 F Pistolet de graissage manuel

I Lubrificatore manuale
 E Pistola de engrase
 CN 大容量黄油枪

COLOR BOX



P (MPa)
27-41

AI



600 cm³

YATO	
YT-07042	6/12



800 cm³

YATO	
YT-07043	4/8

GB Two-way operation grease gun
D Handhebel-Fettpresse
PL Smarownica ręczna, wzmacniona
RUS Шприц для масляной смазки
CZ Páková maznice
H Karos zsírzó

RO Masina de gresat cu furtun rigid
F Pistolet de graissage manuel
I Lubrificatore manuale
E Pistola de engrase
CN 大容量黄油枪

COLOR BOX



500 cm³ P_{max.} 70 MPa AI P 42 MPa

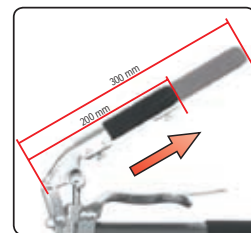
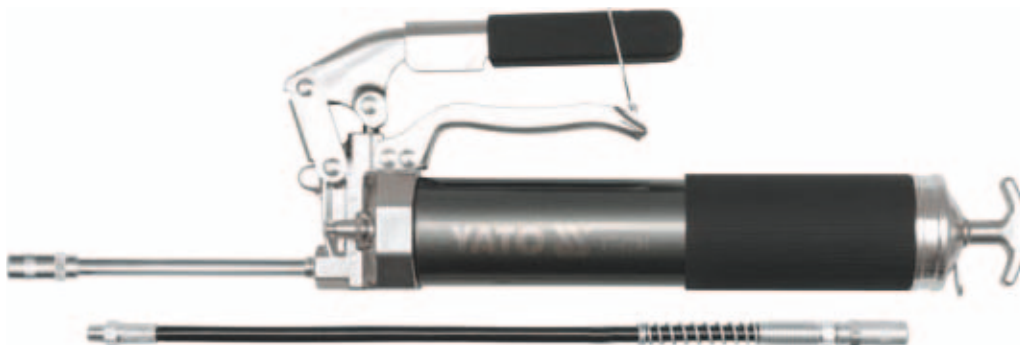

YATO
YT-0704 12

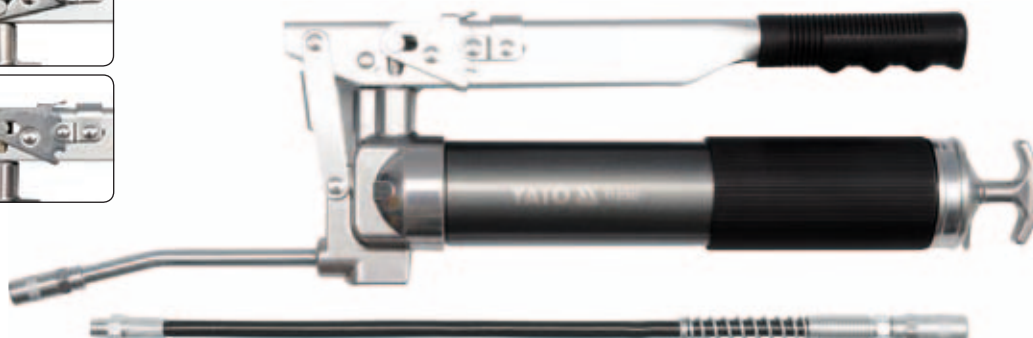

HIGH PRESSURE 69 MPa
LOW VOLUME 14 g / 40 STROKE
WYSOKIE CIŚNIENIE 69 MPa
NISKA WYDAJNOŚĆ 14 g / 40 CYKLI
LOW PRESSURE 6.9 MPa
HIGH VOLUME 100 g / 40 STROKE
NISKIE CIŚNIENIE 6.9 MPa
WYSOKA WYDAJNOŚĆ 100 g / 40 CYKLI

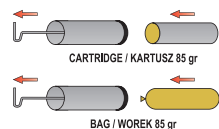

YATO
YT-07041 10

GB Air grease gun
D Druckluft-Fettpresse
PL Smarownica pneumatyczna
RUS Шприц для нагнетания густой смазки пневматический
CZ Mazací lis pneumatický
H Pneumatikus zsírzó
RO Pistol pt. gresat pneumatic
F Pistolet de graissage pneumatique
I Pneumatica per ingrassaggio
E Pistola engrasadora neumática
CN 气动黄油枪

400 cm³ 28 l/min 1/4" 6.3mm

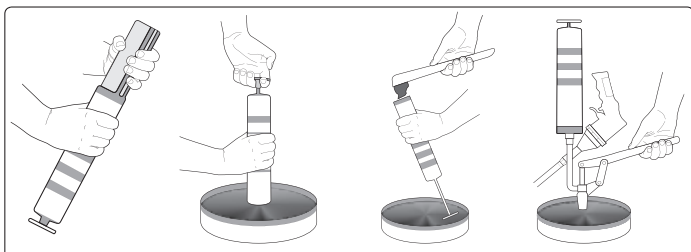

COLOR BOX

YATO
YT-07055 10

- | | | |
|-------------------------------|--|---------------------------------|
| GB Oil transfer pump | H Olajpumpa | E Bomba manual de trasvase dual |
| D Öl-Umfüllpumpe | RO Pompa de ulei de mana | CN 输油泵 |
| PL Pompa transferowa do oleju | F Pompe pour huile | |
| RUS Шприц для перекачки масел | I Lubrificatore manuale per travaso olio | |
| CZ Ruční olejová pumpa | | |

COLOR BOX



500 cm³ P max. 70 MPa P 31 MPa



YATO	
YT-0707	20

- | | |
|------------------------------------|--|
| GB Oil drainer | H Kézi olajszivattyú |
| D Öl-Absaugpumpe | RO Pompa de ulei |
| PL Odsysarka ręczna do oleju | F Seringue à huile |
| RUS Ручной шприц для откачки масла | I Lubrificatore manuale per aspirazione olio |
| CZ Ruční odsávačka oleje | E Bomba manual de trasvase |
| | CN 输油泵 |

COLOR BOX



500 cm³ P max. 70 MPa P 31 MPa



YATO	
YT-0708	20

- | | | |
|-----------------------|--------------------------------|----------------------------|
| GB Grease pump | RO Grăsimă manuală pompa | E Grasa manual de la bomba |
| D Manuelle fettpumpen | F Pistolet de graissage manuel | CN 黄油泵 |
| PL Smarownica ręczna | I Pompa manuali per grasso | |
| RUS Шприц для смазки | | |
| CZ Maznice ruční | | |
| H Kézi zsírzó pumpa | | |

GREY CARTON BOX & COLOR LABEL



13.8 MPa (max) 1.5m HOSE WÄZ



4kg

YATO	capacity / wydajność (kg)	
YT-07061	4	1



8kg

YATO	capacity / wydajność (kg)	
YT-07063	8	1

- | | |
|---------------------------------|---|
| GB Flexible tube for grease gun | H Tömlő a zsírzóhoz |
| D Schlauch für Fettpresse | RO Furtun flexibil pt. pistol de gresat |
| PL Wąż do towotnicy | F Tuyau pour pistolet de graissage |
| RUS Шприц для перекачки масел | I Tubo flessibile per pompe grasso |
| CZ Hadička na maznice na šmír | E Manguera para engrasador |
| | CN 手用黄油枪软管 |

SLIDING CARD





YATO	L (mm)	
YT-0709	300	12/144
YT-0710	500	12/144



- GB Oiler with a flexible applicator
D Ölkanne mit elastischem Applikator
PL Oliwiarka z elastycznym aplikatorem
RUS Масленка с гибким аппликатором
CZ Olejníčka s ohebným aplikátorem
H Hajlékony csövű olajozó
RO Gresor cu aplicator flexibil
F Burette à huile
I Lubrificante con canna flessibile
E Aceitera con aplicador flexible
CN 油壶



IMPACT
RESISTANT
ODPORNE
NA UDERZENIA





YATO 	cm ³	
YT-06912	200	10/120



YATO 	cm ³	
YT-0690	220	10/120
YT-0691	270	10/120



IMPACT
RESISTANT
ODPORNE
NA UDERZENIA



YATO 	cm ³	
YT-06914	500	10/80

YATO 	cm ³	
YT-06913	300	10/120

- GB Oil pump
D Öl-Umfüllpumpe
PL Pompa tłokowa do oleju
RUS Шприц ручной заливной
CZ Ruční olejová pumpa
H Olajpumpa
RO Pompa de ulei de mana
F Pompe pour huile
I Pompa manuale travaso fusti olio
E Bomba manual para aceite
CN 手摇泵

16-18 l/min	▽h 45-90 cm	55 min ⁻¹ (max)
0.3 l CYCLE CYKL	FOR OIL DO OLEJU	Al

- GB Aluminium rotary oil pump
D Aluminium-Kurbelpumpe
PL Aluminiowa pompa do oleju
RUS Алюминиевый ручной бочковой насос
CZ Hliník rotační čerpadlo
H Alumínium rotációs szivattyú
RO Aluminiu pompă rotativă
F Pompe manuelle pour huile
I Pompa a mano per olio
E Aluminio bomba rotary
CN 铝合金手摇油泵

21 l/min	▽h 500 cm	▽h 300 cm
3xPIPE 3xRURA	FOR OIL DO OLEJU	Al



YATO 	
YT-0712	10

- GB High value rotary barrel pump
D Kurbelpumpe für Benzinfässer
PL Wysokowydajna pompa rotacyjna do paliwa
RUS Насос топливный ротационный
CZ Čerpadlo palivové rotační
H Kézi pumpa hordóhoz (forgatható)
RO Pompa rotativa pt. combustibil
F Pompe rotative à combustible
I Pompa rotativa travaso gasolio
E Bomba de combustible rotatoria
CN 手摇泵

FOR FUEL, DIESEL, OIL
DO PALIW I OLEJU

1.0 l CYCLE CYKL	100 l/min
-------------------------------	---------------------

ANTISTATIC HOSE
2.4 m
WAZ ANTYSTATYCZNY

BRASS FILTER
180 µm
MOSZÉZNY FILTR

▽h
100 cm

Al



WHITE
CARTON BOX
& COLOR LABEL



YATO 	
YT-0715	4

GB Two arms jaw puller
 D Abzieher-2-armig
 PL Ściągacz dwuramienny
 RUS Съёмник для подшипников
 CZ Stahovák
 H Csapaágylehűző
 RO Extractor rulmenti

F Extracteur
 I Estrattore
 E Extractor
 CN 两爪拉马



CrV

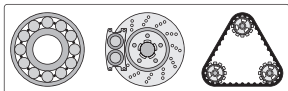

10 mm 4" 100 mm

10 mm 3" 75 mm

YATO	size / rozmiar	max. Ø (mm)	max. force / max. sila nacisku (t)	Box
YT-2514	4" / 100 mm	60	1.2	6/60

YATO	size / rozmiar	max. Ø (mm)	max. force / max. sila nacisku (t)	Box
YT-2515	3" / 75 mm	75	1.1	6/60



17 mm 6" 150 mm



22 mm 8" 200 mm



YATO	size / rozmiar	max. Ø (mm)	max. force / max. sila nacisku (t)	Box
YT-2516	4" / 100 mm	100	1.4	12/48

YATO	size / rozmiar	max. Ø (mm)	max. force / max. sila nacisku (t)	Box
YT-2517	6" / 150 mm	120	6	10/20

YATO	size / rozmiar	max. Ø (mm)	max. force / max. sila nacisku (t)	Box
YT-2518	8" / 200 mm	180	9	6

GB Three arms jaw puller
 D Abzieher-3-armig
 PL Ściągacz trójramienny
 RUS Съёмник для подшипников
 CZ Stahovák třiramenný
 H Csapaágylehűző
 RO Extractor rulmenti cu trei brate

F Extracteur
 I Estrattore
 E Extractor detres patas
 CN 三爪拉马



CrV

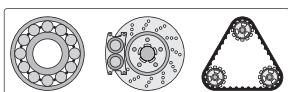

10 mm 3" 75 mm

12 mm 4" 100 mm

YATO	size / rozmiar	max. Ø (mm)	max. force / max. sila nacisku (t)	Box
YT-2519	3" / 75 mm	80	1.5	6/60

YATO	size / rozmiar	max. Ø (mm)	max. force / max. sila nacisku (t)	Box
YT-2520	4" / 100 mm	100	2.5	6/36



22 mm 8" 200 mm



22 mm 12" 300 mm



YATO	size / rozmiar	max. Ø (mm)	max. force / max. sila nacisku (t)	Box
YT-2521	6" / 150 mm	130	5	12

YATO	size / rozmiar	max. Ø (mm)	max. force / max. sila nacisku (t)	Box
YT-2522	8" / 200 mm	180	9	4

YATO	size / rozmiar	max. Ø (mm)	max. force / max. sila nacisku (t)	Box
YT-2523	12" / 300 mm	180	11	2

GB Three arms jaw puller
 D Abzieher-3-armig
 PL Ściągacz trójramienny
 RUS Съёмник для подшипников
 CZ Stahovák třiramenný
 H Csapaágylehűző
 RO Extractor rulmenti cu trei brate

F Extracteur
 I Estrattore
 E Extractor detres patas
 CN 三爪拉马

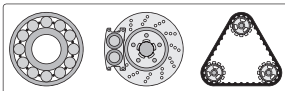

CrV

14 mm 3" 75 mm

YATO	size / rozmiar	Ø (mm)	Box
YT-2511	3" / 75 mm	50-150	20

15 mm 4" 100 mm

YATO	size / rozmiar	Ø (mm)	Box
YT-2512	4" / 100 mm	60-200	20

19 mm 6" 150 mm

YATO	size / rozmiar	Ø (mm)	Box
YT-2513	6" / 150 mm	80-300	10



GB Two leg puller for battery terminals and widescreen wiper arms
 D Abzieher für Scheibenwischer / Wischerarm Spezial-Abzieher Polklemmen
 PL Ściągacz dwuramienny do klem i ramion wycieraczek
 RUS Съёмник стеклоочистителя терминал батареи дворники
 CZ Stahovák na svorky akumulátorů a ramen stěračů
 H Akkusaru és ablaktörölőkar-lehűző
 RO Extractor brat stergator, cleme baterie
 F Extracteur d'essuie glaces et cosse de batterie
 I Estrattore 2 griffe
 E Extractor tirador exterior para brazo del limpiaparabrisas / terminal de batería
 CN 电瓶接头拉马



5-30 mm

ADJUSTABLE NASTAWNY



YATO	Ø (mm)	Box
YT-25145	5-30	48

- GB Universal puller set
D Abziehvorrichtung für Lager
PL Ściągacz do łożysk w miejscach trudnodostępnych
RUS Съёмник подшипников в труднодоступных местах
CZ Sada na stahování ložisek na obličejně dostupných místech
H Csapágyelhúzó nehezen hozzáférhető helyekhez
RO Trăgător pt. rulmenți în locuri greu accesibile
F Extracteur aux roulements
I Set di estrattori universali
E Extractor de rodamientos en lugares de difícil acceso
CN 多功能拉拔器

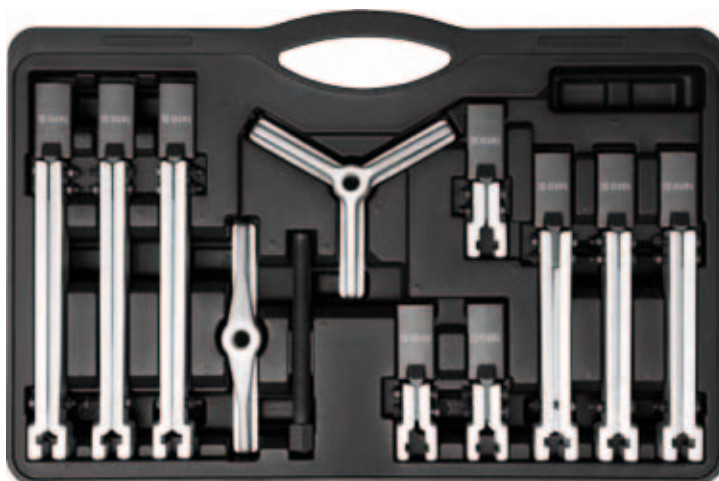
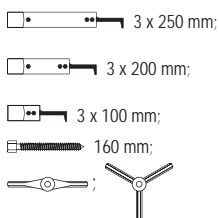

12
PCS
DROP
FORGED
KUTE

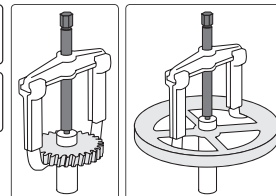

BMC
& COLOR
SLEEVE



YATO		
YT-25105		2

- GB Pilot bearing puller
D Abzieher für Innenlager
PL Ściągacz do łożysk wewnętrznych
RUS Съёмник внутренних подшипников
CZ Stahovák na ložiska vnitřní
H Csapágyelhúzó, belső
RO Clește interior pt. extras rulmenți
F Extracteur intérieur aux roulements
I Estrattore cuscinetti
E Extractor de cojinetes inter.
CN 轴承拉马

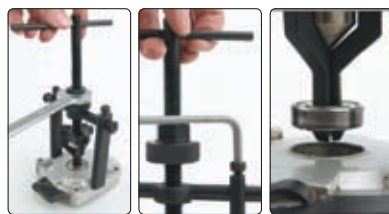

13-38
mm

CrV
6150



YATO	∅ (mm)	
YT-2510	13-38	20

- GB Universal wheel hub puller
D Scheiben- und Trommelbremsen Abzieher
PL Ściągacz uniwersalny do tarcz i bębnow
RUS Универсальный съёмник ступицы и полуоси
CZ Stahovák na brzdové bubny
H Univerzális féktárcsa és fékdob lehúzó

- RO Trusa universala pt. transmisie cardanica
F Extracteur universel pour les disques et les tambours
I Estrattore a vite universale
E Extractor universal de discos y tambores
CN 万用轮毂拉马

CrV

90-140 mm

130-180 mm

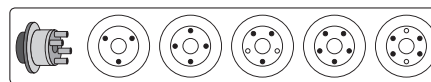

METAL CASE & COLOR BOX

YATO	L (mm)	
YT-0602	200	6

- GB Separator and hydraulic cylinder turnbuckle
D Separator und Abziehvorrichtung mit Hydraulikservomotor
PL Separator i ściągacz z silownikiem hydraulicznym
RUS Сепаратор и съёмник с сервомотором
CZ Oddělovač a stahovák s hydraulickým válcem
H Csapágyelhúzó és körmös csapágyelhúzó hidraulikus kézpumpával
RO Separator și ancoră cu servomotor hidraulic
F Séparateur avec actionneur hydraulique
I Separatore frizione cilindro idraulico
E Separador y tensor de tornillo con cilindro hidráulico
CN 液压分离器组合

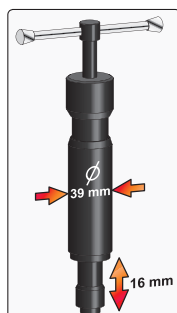

75-105 mm
88-160 mm

50
kN
HYDRAULIC
CYLINDER
SIŁOWNIK
HYDRAULICZNY

HRC
38-45
DROP
FORGED
KUTE

CrV



YATO	F (kN)	
YT-0609	50	2

- GB Twin leg puller with jaw hook
- D Doppel Abzieher mit Haken
- PL Ściągacz uniwersalny dwuramienny
- RUS Съёмник универсальный
- CZ Stahovák dvouramenný univerzální
- H Csapágyelhúzó készlet
- RO Carlig cu falci pt. extras cu picor dublu
- F Extracteur universel à deux bras
- I Estrattore universale a due bracci
- E Extractor de cuatro patas
- CN 单边两爪拉马

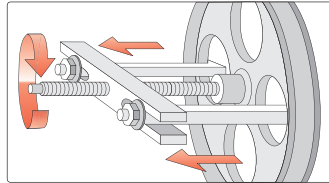
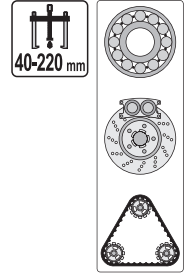

YATO	
YT-0640	10

- GB Gear puller set
- D Lagerabzieher, Trennmesser
- PL Ściągacz dwuramienny i separator
- RUS Съёмник универсальный с сепаратором
- CZ Stahovák dvouramenný
- H Csapágyelhúzó készlet
- RO Set angrenaj pt. extras
- F Extracteur 2 bras + separateur
- I Estrattore a due bracci a separatore
- E Kit de extractor
- CN 齿轮拉拔器

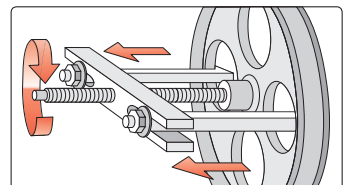
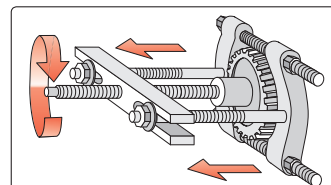
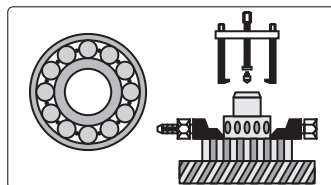
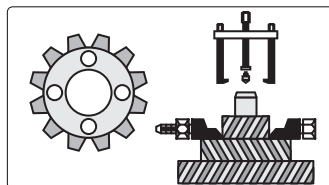
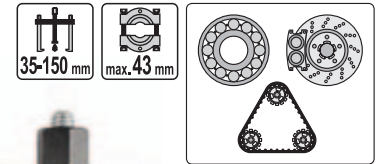

YATO	
YT-0641	4

16

- GB Slide hammer gear / bearing puller set
- D Träge Abziehvorrichtung für Lager
- PL Ściągacz bezwładnościowy do łożysk
- RUS Набор съёмников с обратным молотком
- CZ Rázový stahovák s kluzným kladivem na ložiska
- H Csúszósúlyos csapágyelhúzó készlet
- RO Set ciocan culisant extractor de rulmenti
- F Extracteur de roulements à inertie
- I Set estrattori interni / esterni
- E Extractor de inercia para cojinetes
- CN 滑锤轴承拉拔器组套

5 PCS

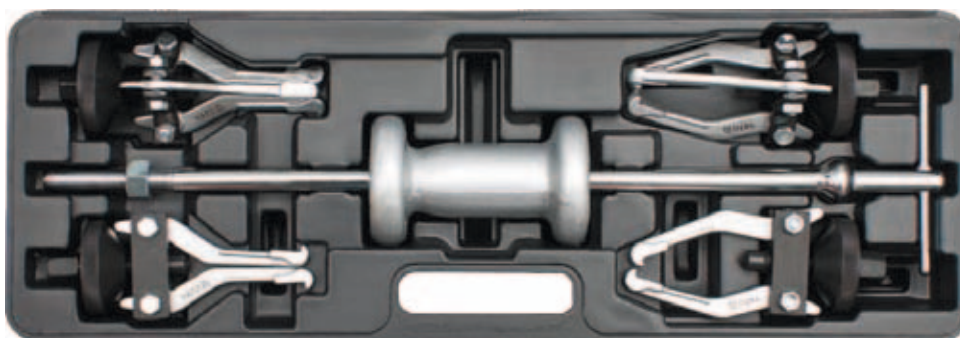
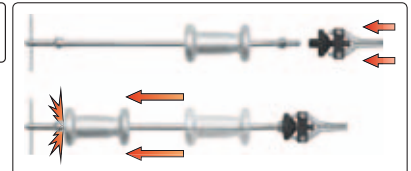

YATO	
YT-2540	2

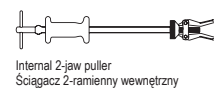
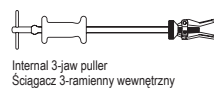
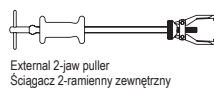
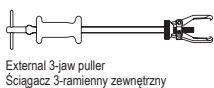

- GB** Slide hammer set
D Träge Abziehvorrichtung für Naben und Lager
PL Ściągacz bezwładnościowy do piast i łożysk
RUS Набор съёмников с обратным молотком
CZ Rázový stahovák s kluzným kladivem na náboje a ložiska
H Csúszósúlyos kerékagy - és csapágyelhúzó készlet

- RO** Set ciocan culisant extractor de rulmenti și bușe
F Extracteur de roulements et moyeux à inertie
I Set estrattori per cuscinetti interno
E Extractor de inercia para cubos y cojinetes
CN 滑锤轴承拉拔器组套

13
PCS

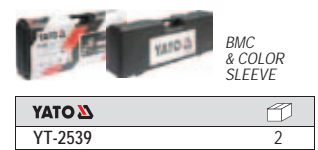
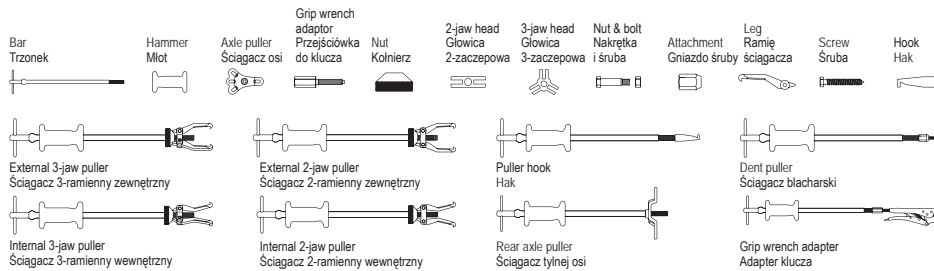
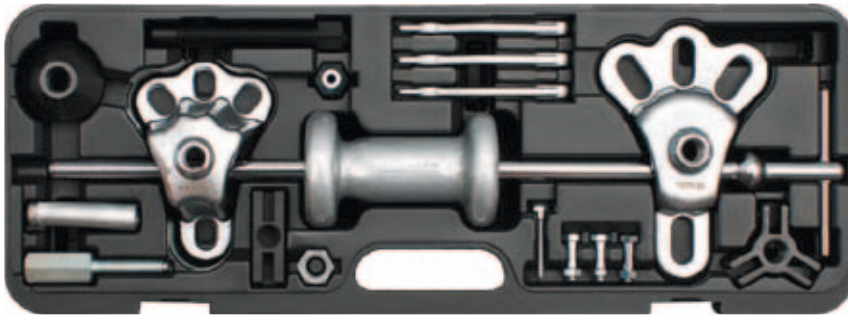
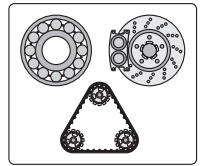
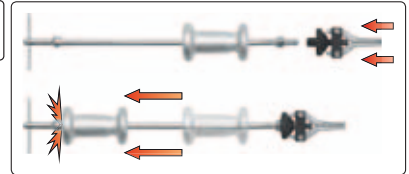

- GB** Slide hammer set
D Träge Abziehvorrichtung für Naben und Lager
PL Ściągacz bezwładnościowy do piast i łożysk
RUS Набор съёмников с обратным молотком
CZ Rázový stahovák s kluzným kladivem na náboje a ložiska
H Csúszósúlyos kerékagy - és csapágyelhúzó készlet

- RO** Set ciocan culisant extractor de rulmenti și bușe
F Extracteur de roulements et moyeux à inertie
I Set estrattori per cuscinetti interno
E Extractor de inercia para cubos y cojinetes
CN 滑锤轴承拉拔器组套

16
PCS

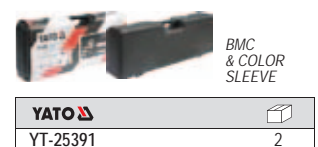
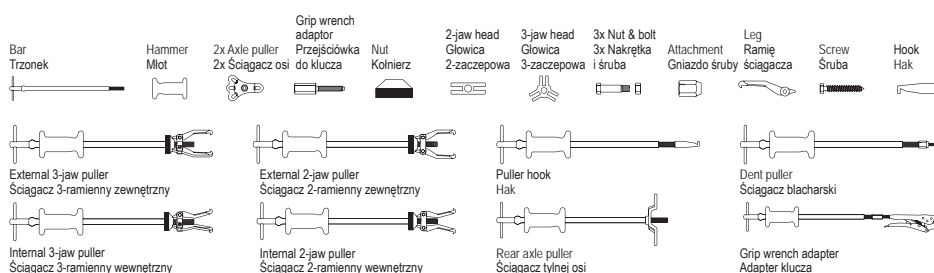
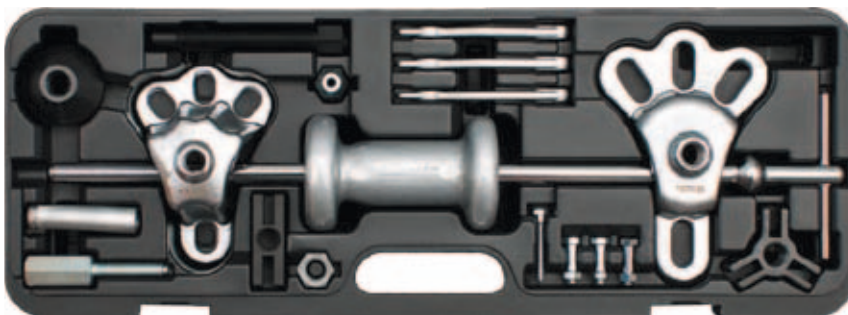
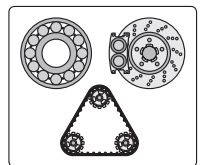
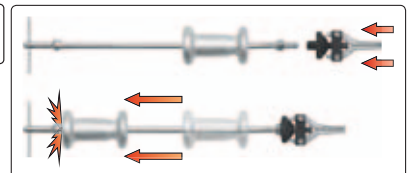

- GB** Front wheel bearing adapter set
D Radlagerabzieher werkzeugsatz vorderachse
PL Ściągacz łożysk piasty przedniej
RUS Набор для снятия переднего подшипника переднеприводных автомобилей
CZ Sada na demontáž ložisek přední nápravy
H Csapágyelhúzó adapter készlet első futóműhöz
RO Set schimbat rulment roata fata
F Extracteur de moyeux
I Set estrattori per cuscinetti ruota anteriore adattatore universale
E Extractor de cojinetes para cubos de rueda delanteros
CN 轴承拆装组套

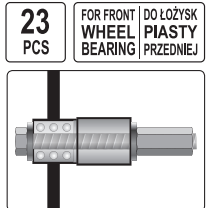
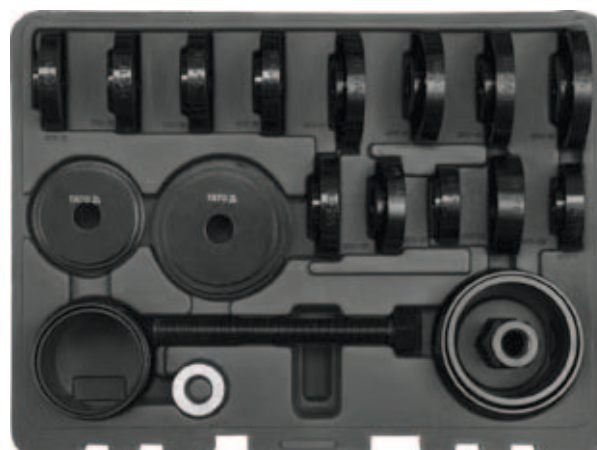

GB Small mouth pull clamp
 D Selbstklemmende Blechschele
 PL Klamra blacharska samozaciskowa
 RUS Скрепa самозажимная для жестяных работ
 CZ Karosářská svěrka samosvorná k tahání

H Önszorító húzóató pofa, egyenes
 RO Clemă pt. tablă cu strângere automată
 F Boucle pour tôle auto-serrant

I Grappa
 E Grapa de hojalatería autoprensora
 CN 窄型张引夹

5t **125 mm** **42x20mm JAWS** **AUTO-TIGHTEN SAMO-ZACISKOWA**

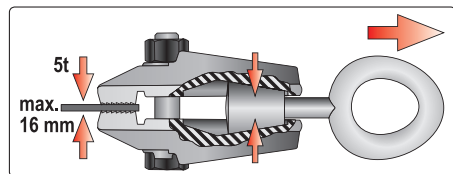

COLOR BOX



YATO	L (mm)	
YT-2542	125	12

GB Box clamp
 D Selbstklemmende Blechschele vom Typ „C“
 PL Klamra blacharska samozaciskowa typu „C“
 RUS Скрепa самозажимная для жестяных работ типа „C“
 CZ Karosářská svěrka samosvorná k tahání typ „C“

I Grappa tipo „C“
 E Grapa de hojalatería autoprensora tipo „C“
 CN 宽型张引夹

3t **142 mm** **35x15mm JAWS** **TYPE C** **AUTO-TIGHTEN SAMO-ZACISKOWA**

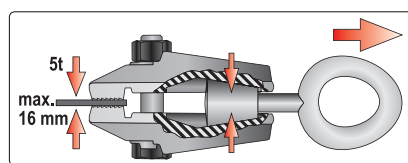

COLOR BOX



YATO	L (mm)	
YT-2543	142	10

GB Twist socket set
 D Schraubendrehersatz
 PL Zestaw wykręteków do śrub
 RUS Инструмент для удаления сломанных винтов
 CZ Sada vyťahováku stržených šroubů
 H Kicsavaró készlet csavarokhoz

RO Set de chei pt. șuruburi
 F Set d'extracteurs aux vis
 I Set estrattori per dadi
 E Juego de destornilladores
 CN 螺栓取出器组套

10 PCS

3/8" 10mm

CrMo HRC 52-55

GB Screw extractor set & HSS drill bits
 D Schraubenausdrehersatz & HSS Bohrer
 PL Wykrętki do zerwanych śrub i wiertła do metalu HSS
 RUS Экстракторы и сверла по металлу HSS
 CZ Vrtáky do přetržených šroubů & vrtáky na kov HSS
 H Törtcsavar kihajtó & főrészár fémhez HSS
 RO Capete pt. deșurubat șuruburi rupte & burghie pt. metal HSS
 F Set d'extracteurs aux vis
 I Estrattori di vite HSS
 E Destornillador para tornillos arrancados & HSS brocas
 CN 断丝取出器组套

12 PCS

HSS

M3-M24

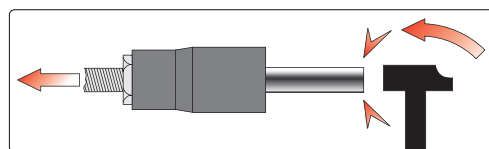

BMC & COLOR BOX



PLASTIC CASE & COLOR BOX



YATO	Ø (mm)	M	Ø [mm]	
YT-0591	1.4-3.6	3-6	1.8	40
	2.1-4.9	6-8	2.6	
	3.1-6.5	8-11	3.7	
	4.8-8.8	11-14	5.5	
	6.2-11.0	14-18	7.0	
	9.4-15.0	18-24	10.3	

YATO		
YT-0603		8/32

GB Screw extractor set
 D Schraubenausdrehersatz
 PL Wykrętki do zerwanych śrub
 RUS Набор для извлечения обломанных болтов
 CZ Vrtáky do přetržených šroubů
 H Törtcsavar kihajtó
 RO Capete pt. deșurubat șuruburi rupte
 F Set d'extracteurs aux vis
 I Estrattori di viti
 E Destornillador para tornillos arrancados
 CN 断丝取出器组套



PLASTIC BOX & SLIDING CARD



6 PCS

YATO	Ø (mm)	L (mm)	
YT-0590	3-6	52	12/48
	6-8	58	
	8-11	66	
	11-14	75	
	14-18	80	
	18-25	88	

- GB Bolt extractor set
D Satz von Ausziehvorrichtungen für Stifte
PL Zestaw wykręteków do szpilek
RUS Набор экстракторов для шпилек
CZ Souprava na demontáž závrtných šroubů
H Csavarkihajtó készlet
RO Set de șurubelnițe pt. tije

- F Set d'extracteurs aux épingles
I Set bussole estrattore per brugola
E Juego de extractores de alfileres
CN 断丝取出器组套

BMC
& COLOR
SLEEVE



STEEL
8660
HRC
49-52

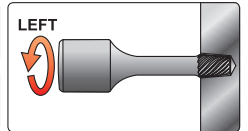

6
PCS

3/8"
10mm



5
PCS

1/2"
12.5mm

YATO	Ø (mm)	
YT-0623	2: 3: 4: 6: 8: 10	50

YATO	Ø (mm)	
YT-0624	8: 10: 12: 14: 16	20

- GB Heavy duty nut splitter
D Meißelsatz für Schraubenmuttern
PL Zestaw przecinaków do nakrętek
RUS Набор зубил для гаек
CZ Souprava sekáčů na matice
H Csavaranya-vágó
RO Set retezatoare capace
F Set de burins
I Set estrattore dado
E Juego de tajaderas para tuercas
CN 螺母破拆组套



BMC
& COLOR
SLEEVE



4
PCS

CrV

HRC
40-45

5/16" - 1/2" (9 - 12 mm);
1/2" - 5/8" (12 - 16 mm);
5/8" - 7/8" (16 - 22 mm);
7/8" - 1-1/16" (22 - 27 mm)

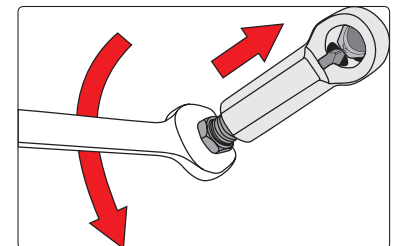

YATO	
YT-0585	10

- GB Roller stud extractor set
D Stehbolzenlösersatz
PL Komplet wykręteków do szpilek
RUS Набор ключей для снятия штифтов
CZ Sada stahovadel na špendlíky
H Komplet tükihúzó
RO Set de dispozitive
pt. demontaj șuruburi rupte
F Set d'extracteurs de goupilles
I Estrattori a rulli per viti prigioniere
E Juego de extractores de agujas
CN 断丝取出器组套



4
PCS

CrV
50BV30

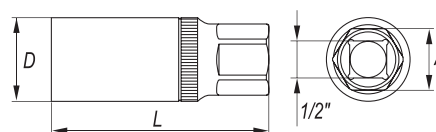
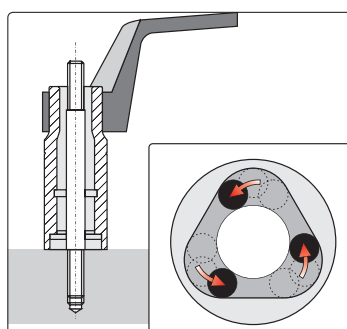

BMC
& COLOR
SLEEVE



YATO	● (mm)	D (mm)	L (mm)	A (mm)	
YT-0620	6	24	60	21	6/24
	8				
	10	28	70		
	12				

- GB Stud extractor
- D Stehbolzenausdreher
- PL Wykręтак do śrub szpilek i nakrętek
- RUS Шпильковерт универсальный
- CZ Klíč na povolení závrtných šroubů
- H Sérültféjű csavar kisedző
- RO Extractor pt. suruburii
- F Extracteur de goujon, écrou ou boulon arrondis
- I Stud estratore
- E Extractor de esparragos
- CN 断螺丝取出器





1/2"
12.5mm

8.5-19
mm



COLOR BOX

YATO 	
YT-06251	10/30

- GB Tie rod end lifter
- D Universal-Kugelgelenk-Abzieher
- PL Ściągacz do sworzni kulistych
- RUS Съёмник шаровых опор
- CZ Stahovák kulových čepů řízení
- H Gömbfej kinyomó
- RO Extractor pt. articulatii sferice

- F Extracteur de rotue
- I Estrattore per snodi sferici
- E Extractor de pernos esféricos
- CN 球头拉拔器



100
mm

20-60
mm



COLOR BOX



YATO 	 (mm)	L (mm)	Ø (mm)	
YT-06122	19	100	20	20

- GB Tie rod end lifter
- D Universal-Kugelgelenk-Abzieher
- PL Ściągacz do sworzni kulistych
- RUS Съёмник шаровых опор
- CZ Stahovák kulových čepů řízení
- H Gömbfej kinyomó
- RO Extractor pt. articulatii sferice



- F Extracteur de rotue
- I Estrattore per snodi sferici
- E Extractor de pernos esféricos
- CN 球头拉拔器

135
mm



COLOR BOX



YATO 	 (mm)	L (mm)	Ø (mm)	
YT-0612	19	135	17.5	9/18

- GB Tie rod end lifter
- D Universal-Kugelgelenk-Abzieher
- PL Ściągacz do sworzni kulistych
- RUS Съёмник шаровых опор
- CZ Stahovák kulových čepů řízení
- H Gömbfej kinyomó
- RO Extractor pt. articulatii sferice
- F Extracteur de rotue
- I Estrattore per snodi sferici
- E Extractor de pernos esféricos
- CN 球头拉拔器





265
mm

275
mm

COLOR BOX



YATO 	 (mm)	L (mm)	Ø (mm)	
YT-0613	16	265	17	20
YT-0614	16	275	20	20

- GB Rod end remover
- D Lenkstangeabzieher
- PL Ściągacz do drążków kierowniczych
- RUS Съёмник рулевых тяг
- CZ Přípravek na demontáž kulových čepů řízení
- H Gömbfej kiütő
- RO Tija pt. indepartat
- F Extracteur pour rotules de direction
- I Estrattori perni e tiranti sterzo
- E Extractor de barras de acoplamiento
- CN 拉拔器



200
mm

70mm
18mm

COLOR BOX



YATO 	L (mm)	
YT-0615	200	18/36

- GB Inner tie rod tool
- D Spurstangengelenk Lösewerkzeug
- PL Klucz do drążków kierowniczych
- RUS Ключ для шарнира рулевой рейки
- CZ Přípravek na axiální táhla
- H Csukló szerelő
- RO Cheia de la tija de cravată
- F Clé pour rotules de direction
- I Chiave per il tirante
- E Extractor mecanismo de dirección
- CN 大机杆扳手



Ø mm
35-42

COLOR BOX



YATO 	
YT-06160	25

- GB Track rod end remover & installer set
- D Schlüsselsatz für Zahnstangenlenkung
- PL Zestaw kluczy do drążków kierowniczych
- RUS Набор ключей для рулевых тяг
- CZ Sada klíčů pro řízení
- H Kormányrúd telepítő készlet-eltávolító
- RO Set montare-demontare bieleta
- F Clé pour rotules de direction
- I Set di chiavi suggerimenti smontaggio tiranti sterzo
- E Herramienta de llaves para barras de dirección
- CN 件套轴接头工具组

4 PCS \varnothing mm 30-45

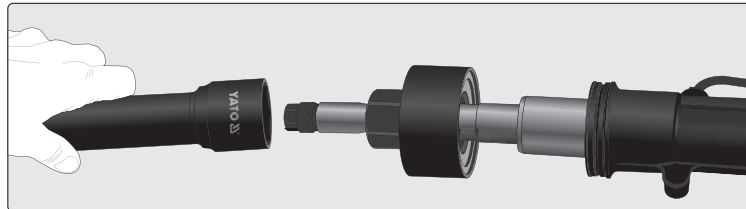

BMC & COLOR SLEEVE



\varnothing 30-35mm, 35-40mm, 40-45mm

YATO 	
YT-06155	2

- GB Tie rod / ball joint tool kit
- D Werkzeugsatz für Bremssattel
- PL Ściągacze do drążków
- RUS Съёмник штанг
- CZ Stahováky táhel řízení
- H Rúdlehúzó
- RO Ancore pt. tije
- F Set d'extracteurs pour rotules de direction
- I Set tiranti per estrattore
- E Tensores para palancas
- CN 球头拉拔器组套

6 PCS



BMC & COLOR SLEEVE

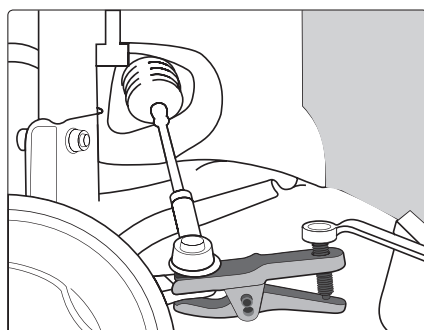

YATO 	
YT-06157	4

- GB Tie rod / ball joint tool kit
- D Werkzeugsatz für Bremssattel
- PL Ściągacze do drążków
- RUS Съемник штанг
- CZ Stahováky táhel řízení
- H Rúdlehúzó
- RO Ancore pt. tije
- F Set de leviers à tête réglable
- I Set di estrattori perni e tiranti sterzo
- E Tensores para palancas
- CN 球头拉拔器组套

for / dla: YT-0990

5
PCS

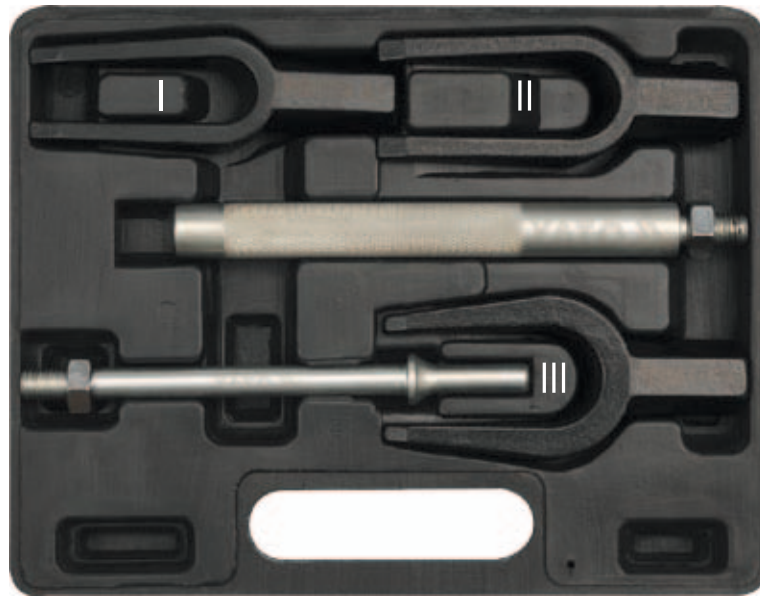

BMC & COLOR BOX

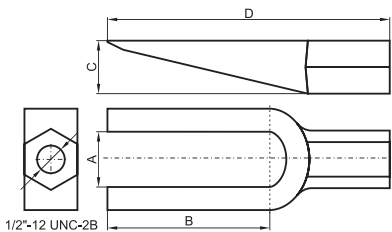
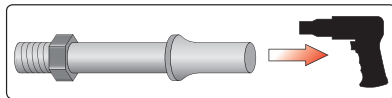
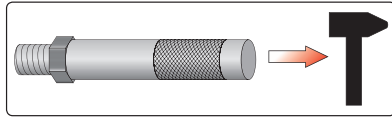

YATO		A (mm)	B (mm)	C (mm)	D (mm)	
YT-0616	I	18.2	65.0	24.0	123.9	10
	II	25.2	67.8			
	III	30.2	56.3			

- GB Seal puller
- D Dichtungs-Abziehwerkzeug
- PL Ściągacze do uszczelek
- RUS Съемник прокладок
- CZ Škrabka na těsnění
- H Tömítéslehúzó
- RO Ancoră pt. garnituri
- F Outil pour extraire les joints
- I Estrattore per guarnizioni
- E Tensor para juntas
- CN 密封圈拉拔器

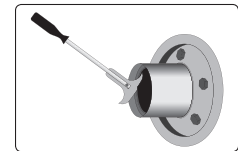

max. Ø
85mm

SLIDING CARD

YATO	L (mm)	
YT-0642	200	12/48

- GB Bearing race and seal driver set
- D Presssatz für sicherungsringe, lager, etc.
- PL Zestaw do osadzania łożysk i uszczelniaczy
- RUS Втулка и набор сальниковых уплотнителей для автомобиля
- CZ Sada na montáž gufer
- H Csapágy, szimering, persely ki- és beütő készlet
- RO Set pt. inlocuit rulment, simering
- F Set de simerings
- I Set di tamponi per cuscinetti e guarnizioni
- E Jugeo de conductores del anillo y del sello de rodadura
- CN 斜型培令套安装器



10
PCS

AI

BMC & COLOR SLEEVE

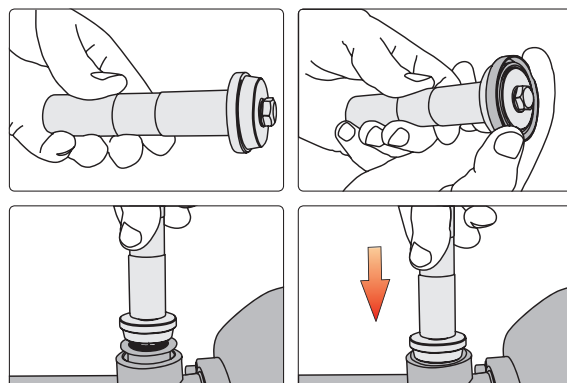

YATO	No.	Ø (mm)	
YT-0638	01	40	5/10
	02	44	
	03	50	
	04	59	
	05	63	
	06	65	
	07	72	
	08	76	
	09	81	

- GB Car radio removal tool set
D Autoradio Demontage Werkzeugsatz
PL Zestaw do demontażu radioodbiorników samochodowych
RUS Набор для разборки авто-ресиверов
CZ Sada k demontáži autorádií
H Autórádió kiszereelő készlet
RO Trusa de scule pt. indepartat radio
F Set d'outils pour dépose autoradio
I Set estrattori per autoradio
E Juego para el desmontaje de autorradio
CN 收音机拆卸组套

- 2 radio removal U-hook (Ford, VW, Audi, Grundig, Blaupunkt)
- 1 special pentagon wrench (BMW)
- 4 radio removal keys (VW, Audi, Becker, Mercedes)
- 2 radio removal keys (Mercedes, Porsche, Becker)
- 2 radio removal keys (VW)
- 1 allen hex wrench (BMW, Opel)
- 2 radio removal keys (new Becker)
- 2 radio removal keys (new Skoda)
- 2 radio removal keys U-hook (new Blaupunkt)
- 2 radio removal keys (Fiat Brava)
- 2 radio removal U-hook (Opel Doppel-Kugel-Inbus)
- 6 radio removal keys (Mercedes-Benz, BMW)
- 2 radio removal keys (Kenwood II 1998-2001)
- 2 radio removal keys (Sony II since 2002)
- 2 radio removal keys (Kenwood III since 2002)
- 2 radio removal keys (Pioneer, JVC)
- 2 radio removal keys (Sony I until 2001)
- 2 radio removal keys (Panasonic)
- 2 radio removal keys (Kenwood I until 1998)
- 2 radio removal keys (Kenwood mask)
- 2 radio removal keys (new Clarion)
- 2 radio removal keys (old Clarion)
- 2 radio removal keys (Panasonic 2006)
- 2 radio removal keys (Sony IDIC 2005)

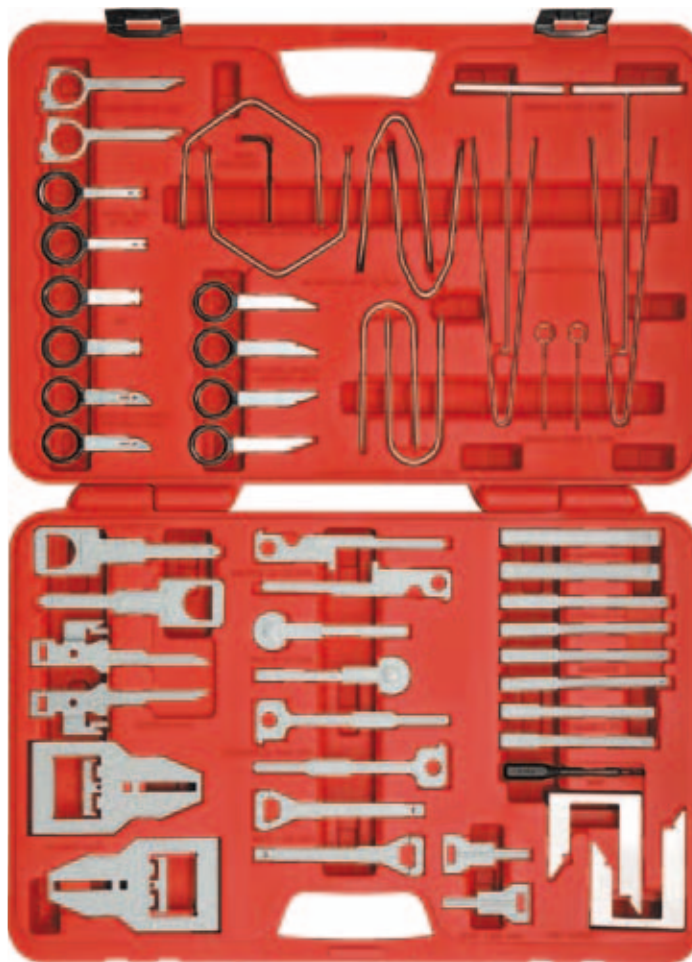

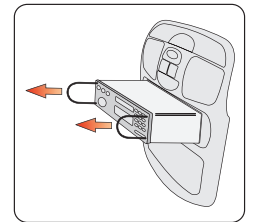
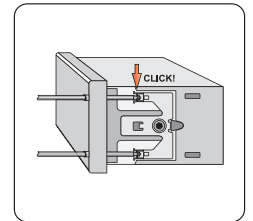
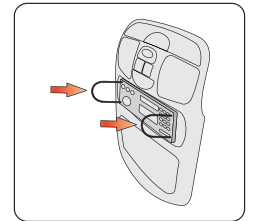

52
PCS



BMC
& COLOR
SLEEVE



YATO 	
YT-0838	10

- GB Emergency automotive lock-out tool set
D Werkzeugsatz zum Öffnen der Autotür im Notfall
PL Zestaw do awaryjnego otwierania drzwi samochodowych
RUS Набор для аварийного відкриття автомобільних дверей
CZ Souprava k nouzovému otevření dveří automobilů
H Személygépkocsi ajtó vésznyitó készlet
RO Set pt. deschiderea de avarie a ușilor de mașină
F Set ouverture de porte fermée
I Set estrattori per apertura automotore
E Juego de herramientas para abrir las puertas de coche en casos de urgencia
CN 车门锁拆卸工具



9
PCS



STAINLESS
STEEL
STAL
NARZĘDZIA

PVC

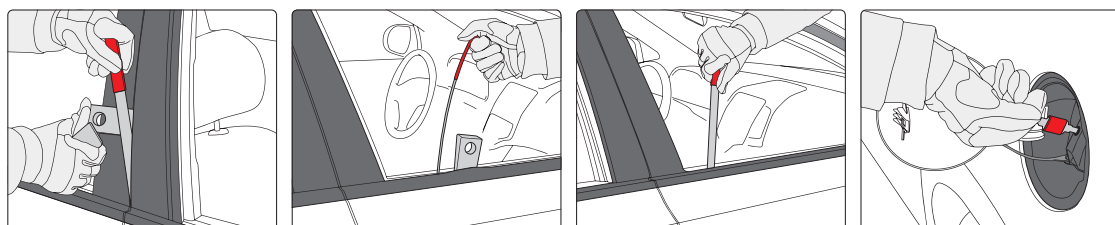
16



POUCH

YATO 	
YT-08385	25

GB Door upholstery remover
D Abziehvorrichtung für Polstererklammern
PL Ściągacz do spinek tapicerki
RUS Съемник крепежа обивки



CZ Uvolňovač čalounění dveří
H Kárpitkiszedő
RO Dispozitiv de scos agrafe de tapițerie

F Arrache agrafes
I Estrattore per la rimozione di graffette tappezzeria



E Extractor de grapas de vestidura
CN 胶扣起子

SVCM





YATO 	size / rozmiar (mm)	
YT-1370	6x100	12/120





YATO 	size / rozmiar (mm)	
YT-1371	6.2x115	12/120



YATO 	size / rozmiar (mm)	
YT-1372	10x115	12/120



YATO 	size / rozmiar (mm)	
YT-1373	9.5x134	6/96

GB Scratch awl
D Einfache Spicknadel
PL Szpikulec prosty



RUS Прямое острие
CZ Šídlo rovné
H Spékelőtű, egyenes

RO Dorn perforare drept
F Brochette droite
I Punteruolo piatto

E Punzón recto
CN 锥子

SVCM



YATO 	L (mm)	
YT-1374	120	12/120

16

GB Hook bodkin
D Hakenspicknadel
PL Szpikulec hakowy

RUS Крюковое острие
CZ Šídlo háčkové
H Spékelőtű, horgos



RO Dorn perforare îndoit
F Brochette coudée
I Gancio punteruolo

E Punzón encorvado
CN 油封拉拔器

SVCM

90°





YATO 	L (mm)	
YT-1375	125	12/120

GB Battery cap tool
D Abziehvorrichtung für Akkuklemmen
PL Ściągacz do клем akumulatora
RUS Стяжка для клемм аккумулятора
CZ Stahovák svorek akumulátoru
H Akkumulátor saru lehúzó
RO Extractor pt. clemă acumulator
F Tournevis plat pour bouchons de batterie
I Batteria clem estrattore
E Extractor para los bornes de la batería
CN 扁铲



SVCM

YATO 	size / rozmiar (mm)	
YT-1378	18.5x100	12/120

- GB Glass scraper RUS Шабер для стекла RO Răzuitor geamuri E Rascador para los vidrios
D Scheibenkratzer CZ Škrabka na okna F Gratteur pour vitres
PL Skrobak do szyby H Jégkaparó I Raschietto per vetro CN 刮刀

SVCM



YATO	size / rozmiar (mm)	
YT-1379	39x200	6/72

- GB Spare blades for glass scraper
D Abbrechklängen
PL Ostrze do skrobaka do szyby
RUS Лезвия для универсальных ножей
CZ Lomené ostří náhradní
H Törhető tartalékpenge
RO Lame de rezervă rupte
F Lames pour gratteur pour vitres
I Lame per raschietto
E Filo partido de recambio
CN 刮刀刀片



COLOR BOX



10 PCS SK5

for / dla: YT-1379

YATO	size (mm)	
YT-13790	19x39	50

- GB Flexible spinner handle RUS Эластичный вороток RO Mâner flexibil E Llave flexible
D Elastischer Dreher CZ Šroubovák ohebný F Barre élastique CN 套筒螺丝批
PL Pokrętło elastyczne H Hajlékony csavarhúzó I Chiave flessibile

1/4" 6.3mm SVCM



YATO	size / rozmiar	
YT-1381	1/4" (6.3 mm) x 150 mm	6/96

- GB Flexible magnetic bit driver CZ Šroubovák ohebný na bity I Chiave flessibile
D Elastischer Dreher für Bits H Hajlékony csavarhúzó bit E Mango flexible para desarmadores
PL Pokrętło elastyczne do bitów RO Mâner flexibil pt. vârf șurubelniță CN 批头螺丝批
RUS Эластичный вороток для разряда битов F Barre élastique

SVCM 



YATO	size / rozmiar	
YT-1382	1/4" (6.3 mm) x 380 mm	6/72

- GB Flexible magnetic pick up tool CZ Ohebný magnetický držák I Chiave flessibile
D Elastische Magnethalterung H Hajlékony mágneses szár E Mango magnético flexible
PL Elastyczny uchwyt magnetyczny RO Mâner magnetic flexibil CN 拾拾器
RUS Эластичный магнитный держатель F Capteur magnétique

SVCM 



YATO	L (mm)	
YT-1385	400	6/72

- GB Door upholstery remover RUS Съёмник крепежа обивки F Spatule d'extraction de clips E Extractor de grasas de vestidura
D Abziehvorrichtung für Polstererklammern CZ Uvolňovač čalounění dveří I Estrattore per la rimozione di graffette tappezzeria
PL Ściągacz do spinek tapicerki RO Dispozitiv de scos agrafe de tapiterie

SLIDING CARD



230 mm 

YATO	L (mm)	
YT-0841	230	16/64



200 mm 

YATO	L (mm)	
YT-0842	200	25/100

- GB Panel removal set
 D Abziehvorrichtung für Polsterung
 PL Ściągacze do tapicerki
 RUS Съемник обивки
 CZ Sada k demontáži čalounění
 H Kárpitlehúzó
 RO Ancore pt. tapițerie
 F Set d'extracteurs à la tapisserie
 I Leve in plastica per la tappezzeria
 E Tensores para las vestiduras
 CN 面板拆卸组套

DOUBLE BLISTER



IMPACT RESISTANT NYLON
 ODPORNE NA UDERZENIA
 NO SCRATCH BEZ ZADRAPAN

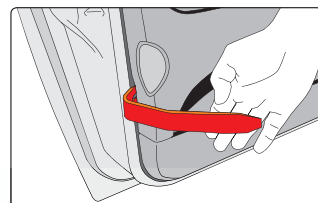

5 PCS

6 PCS

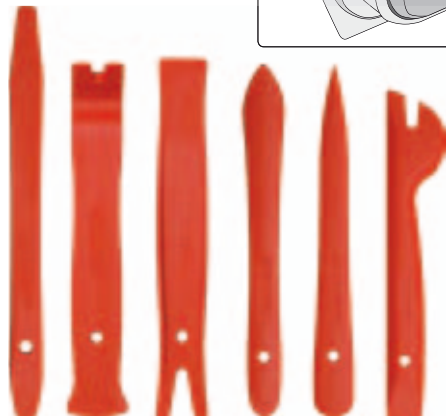

YATO
 YT-0836 6/24

YATO
 YT-0837 6/24

- GB Panel removal set
 D Abziehvorrichtung für Polsterung
 PL Ściągacze do tapicerki
 RUS Съемник обивки
 CZ Sada k demontáži čalounění
 H Kárpitlehúzó
 RO Ancore pt. tapițerie
 F Set d'extracteurs à la tapisserie
 I Leve in plastica per la tappezzeria
 E Tensores para las vestiduras
 CN 面板拆卸组套

POUCH & COLOR BOX



11 PCS

- GB Set of plastic scrapers
 D Satz von Kunststoffschabern
 PL Zestaw skrobaków plastikowych
 RUS Набор пластмассовых шаберов
 CZ Souprava plastových škrabek
 H Műanyag vakaró készlet
 RO Set de răzuitoare din plastic
 F Kit de grattoirs en plastique
 I Set di raschietto
 E Juego de rascadores de plástico
 CN 塑料刮刀

4 PCS

265 mm

IMPACT RESISTANT NYLON
 ODPORNE NA UDERZENIA
 NO SCRATCH BEZ ZADRAPAN



YATO
 YT-0844 5/10



3/4" (19 mm) 7/8" (22 mm) 1" (25 mm) 1.1/2" (37.5 mm)

YATO
 YT-0847 L (mm) 265 6/36

SLIDING CARD



- GB Quick release cut out tool
 D Schneidmesser für Scheiben
 PL Nóż do wycinania szyb
 RUS Нож для вырезания стекол
 CZ Nůž na vyřezávání skel
 H Szélvédőkivágó kés
 RO Cuțit tăietor de geam
 F Kit de découpe pare-brise
 I Tagliolo per il verto
 E Cuchilla para cortar cristales
 CN 玻璃橡胶刮除器

3x BLADES OSTRZA
 ALU HANDLE UCHWYT
 QUICK RELEASE SZYBKO-ZŁĄCZE
 K5



SLIDING CARD



YATO
 YT-0659 20/40

- GB Spare blades for cut out tool
 D Abbrechklingenn
 PL Ostrza zapasowe do noża do wycinania szyb
 RUS Лезвия для ножей
 CZ Ostří náhradní
 H Törhető tartalékpenge
 RO Rezerve cutter
 F Lames
 I Lame di ricambio per coltello specialistica per tagliare vetri del auto
 E Filo partido de recambio
 CN 玻璃橡胶刮除器刀片

3x BLADES OSTRZA
 K5
 for / dla: YT-0659



SLIDING CARD



3/4" (19 mm);
 1" (25 mm);
 1-1/2" (38 mm)

YATO
 YT-06590 10/80

- GB Windshield removal set
- D Demontagesatz für Autoscheiben
- PL Zestaw do demontażu szyb samochodowych
- RUS Набор для демонтажа автостекла
- CZ Souprava na demontáž autoskel
- H Szélvédőcsereelő szett
- RO Set pt. demontarea geamurilor de mașină
- F Kit pour démontage de vitres de voiture
- I Set di strumenti di rimozione parabrezza
- E Juego para desmontaje de cristales de coches
- CN 风挡玻璃拆卸组套



7
PCS

HRC
38-42

COLOR BOX



YATO

YT-0845 10

- GB Windscreen wiper arm removal tool
- D Abziehvorrichtung für die Scheibenwischerarme
- PL Ściągacz do ramion wycieraczek
- RUS Съёмник поводков стеклоочистителя
- CZ Stahovák na ramínka stěračů
- H Ablaktörökár lehűző
- RO Siguranță pt. bratele ștergătoarelor
- F Bord aux bras d'essuie-glace
- I Estrattore di parabrezza tergicristallo braccio
- E Herramienta para desmontaje de las plumas de los limpiaparabrisas
- CN 雨刷臂拆卸工具

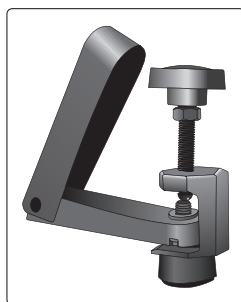

SLIDING CARD



YATO

YT-0846 12/120

- GB Two leg puller for battery terminals and windscreen wiper arms
- D Abzieher für Scheibenwischer / Wischerarm Spezial-Abzieher Polklemmen
- PL Ściągacz dwuramienny do klem i ramion wycieraczek
- RUS Съёмник стеклоочистителя терминал батареи дворники
- CZ Stahovák na svorky akumulátorů a ramen stěračů
- H Akkusaru és ablaktörökár-lehűző
- RO Extractor brat stergator, cleme baterie
- F Extracteur d'essuie glaces et cosse de batterie
- I Estrattore 2 griffe
- E Extractor tirador exterior para brazo del limpiaparabrisas / terminal de batería
- CN 电瓶接头拉马

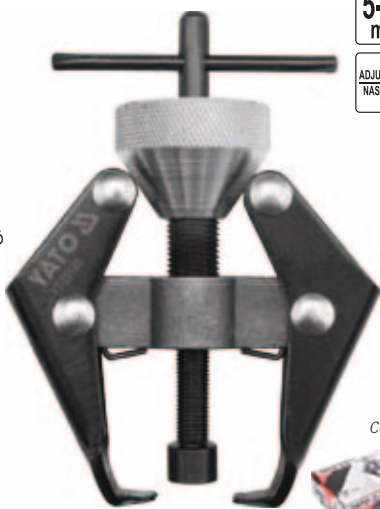

5-30
mm

ADJUSTABLE
NASTAWNY

COLOR BOX

YATO

YT-25145 ∅ (mm) 48

- GB Spring clamp remover V.A.G.
- D Auspuff Federklammer entferner / installer für V.A.G.
- PL Ściągacz do obejm i sprężyn V.A.G.
- RUS Съёмник пружинных, хомутов систем выпуска V.A.G.
- CZ Přípravek na montáž a demontáž svorky výfuku V.A.G.
- H Kipufogó rugó szerelő V.A.G.
- RO Dispozitiv montat / demontat esapament V.A.G.
- F Tuyau d'échappement printemps pince outil de suppression pour V.A.G.
- I Spring clamp rimozione
- E Abrazadera de resorte herramienta de eliminación-para V.A.G.
- CN 弹簧撑

17
mm

FOR / DLA
V.A.G.

SLIDING CARD



YATO

YT-25331 12/36

- GB Puller for ribbed drive pulley
- D Riemenscheiben Abzieher Werkzeug Keilriemenscheiben
- PL Ściągacz kół pasowych wielorokowych
- RUS Универсальный съёмник шкива

- CZ Staviteľný stahovák drážkových řemenic
- H Bordás szíjtárcsa lehűző
- RO Tragator de scripete reglabil
- F Universel extracteur de poulie d'entraînement cannelé

- I Estrattore puleggia motrice a coste
- E Extractor de polea acanalada
- CN 皮带轮拉马

40-165mm

17mm
3/8"

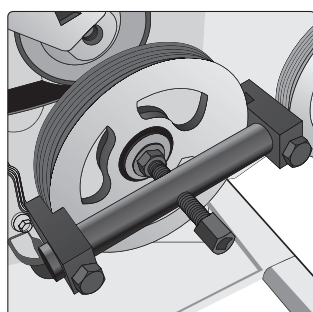

COLOR BOX



YATO

YT-25480 10

- GB CV boot clamp pliers
- D Zange für Schellen der Gelenkabdeckung
- PL Szczypce do oprasek osłony przegubu
- RUS Щипцы для хомутов крепления кожуха шарнира
- CZ Kleště na spony manžety kloubu
- H Féltengely bilincs húzó fogó
- RO Clește pt. brătară de husă la articulație
- F Pince pour collier à recouvrement de joint
- I Pinza a morsetto per fascette pinzabili
- E Alicates para abrazadera de protección de la junta
- CN 夹紧钳

SLIDING CARD



235 mm
CrV

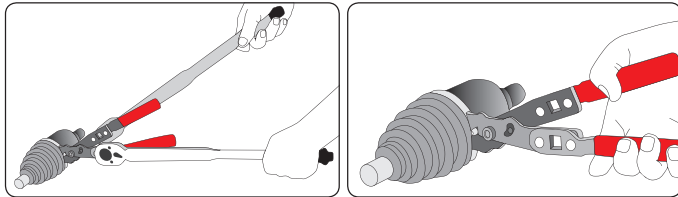

YATO	L (mm)	
YT-0606	235	6/36

- GB Lock-ring pliers
- D Spreizzange für Schellen
- PL Szczypce rozporowe do pierścieni osadycznych
- RUS Щипцы распорные для стяжных хомутов
- CZ Kleště na hadicové spony
- H Seeger fogó
- RO Clește pt. desfacerea brățarelor de strângere
- F Pince tenaille pour les bagues de retenue
- I Pinza per rondelle elastiche scanalata
- E Alicates para abrazaderas
- CN C型扣钳

SLIDING CARD



225 mm
CrV

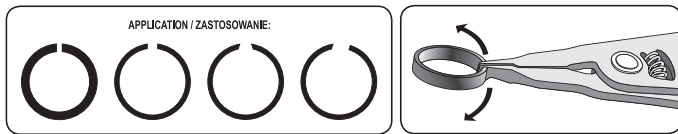

YATO	L (mm)	
YT-0607	225	12/72

- GB Fuel feel pipe pliers
- D Zange für Tankverschlüsse
- PL Szczypce do złączek paliwowych
- RUS Щипцы для топливных соединений
- CZ Kleště na spojky palivového systému
- H Üzemanyagvezeték fogó
- RO Clește pt. conectoare de combustibil
- F Pince tenaille pour connecteurs de carburant
- I Pinza per tubo carburante
- E Alicates para enchufes de combustible
- CN 油管钳

SLIDING CARD



AI

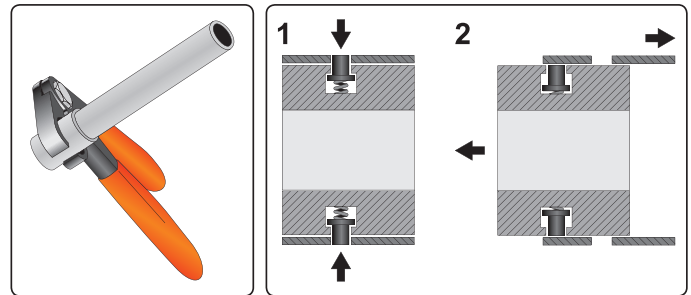

YATO	
YT-0608	10/40

- GB Hose removing pliers
- D Schlauch- und Kabelösezange
- PL Szczypce do zdejmowania przewodów
- RUS Клещи для снятия изляци
- CZ Kleště na demontáž hadic
- H Tömlőbilincs fogó
- RO Clește pt. indepartat furtune
- F Pince pour enlever les fils
- I Pinza spelacavi universale
- E Alicates de extracción de mangueras
- CN 油管分离钳

SLIDING CARD

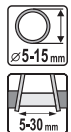

YATO	
YT-0657	6/36

- GB Transmission line disconnect tool set
- D Werkzeugsatz zum Trennen von Kraftstoffleitungen
- PL Zestaw do rozłączania przewodów
- RUS Набор для рассоединения топливopроводов
- CZ Sada na rozpojování palivového potrubí
- H Üzemanyagcső-lebontó készlet
- RO Set pt. deconectarea liniilor de combustibil
- F Set pour disjoindre des câbles
- I Set per scollegare i tubi di carburante
- E Juego para desconectar conductos de combustible
- CN 油管拆卸组套



8 PCS

FOR A/C DO KLIMATYZACJI

FOR FUEL LINE DO PRZEWODÓW PALIWA



BMC & COLOR SLEEVE

YATO	
YT-0630	20

- GB Spark plug puller set VAG
D Abzieher-Satz Zündspulen VAG
PL Zestaw ściągaczy do świek zapłonowych VAG
RUS Набор съемников для катушек зажигания VAG
CZ Sada stahováků zapalovací cívký
H Gyújtótekercs lehozó készlet
RO Set bobina de aprindere tragator
F Set d'extracteurs des bobines d'allumage
I Set per la rimozione rapida bobine di accensione nelle auto VAG
E Extractores bobinas de encendido grupo VAG
CN 四件套火花塞维修工具



4
PCS
FOR / DLA
V.A.G.

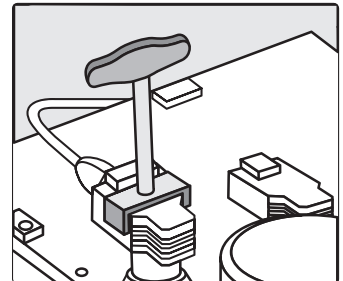

for / dla: VW, Audi, Skoda, Seat

YATO			
YT-06205	T type 1		Volkswagen FSI Golf / Bora 1998, Polo 2002, Touran 2004, New Beetle 2003, Passat 1997, T4+Audi A2 2001
	T type 2		Silniki/engines 6 cyl. 24V, 5 cyl. Golf / Bora 1998, Passat / Touareg 1997, Sharan 1996, Phaeton / Toureg 6 cyl. 2003, T5 z 6 cyl. silnikiem 2004
	T type 3		Volkswagen silnik / engines 2.0 z bezp. wtrysk / direct injection, Touran 2004, Passat 2006, Audi z bezp. wtrysk / direct injection A3 2.0 2004, A6 3.2 2005
	T type 4		Volkswagen z bezp. wtrysk / direct injection 2.0, Golf / Touran 2004, Passat 2006, Audi z bezp. wtrysk / direct injection, A3 2.0 2004, A6 3.2 2005

- GB Spark plug terminal pliers
D Zange für das Zündkerzenkabel
PL Szczypce do przewodów świec zapłonowych
RUS Щипцы к проводам свечей зажигания
CZ Kleště na kabely zapalovacích svíček
H Gyújtógyertya-kábel fogó

- RO Clește pt. conductele bujiilor de aprindere
F Pince pour fils d'allumage
I Pinze per candele
E Pinzas para los cables de las bujías de ignición
CN 火花塞高压线钳

SLIDING
CARD



200
mm
255
mm

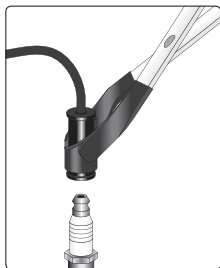

YATO	L (mm)	
YT-7320	255	10/60

- GB Multi-purpose hose & wire pliers
D Zangensatz für Schellen und Leitungen
PL Komplet szczypiec do opasek i przewodów
RUS Набор щипцов к хомутам и проводам
CZ Souprava kleští na spony a hadice
H Fogókészlet bilincsekhez és vezetékhez
RO Set clește pt. benzi și conducte
F Pince pour collier de serrage
I Set pinze per il morsetto
E Juego de pinzas para abrazaderas y cables
CN 多功能管夹钳

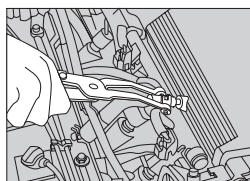

For engine air pipe
Do przewodów powietrznych listwy wtryskowej

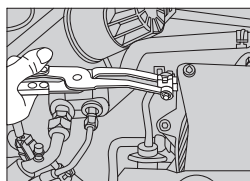

For engine intake air pipe
Do przewodów gumowych układu zasilania

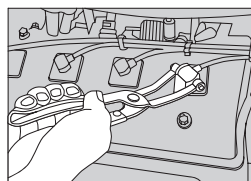

For spark plug lead
Do przewodów zapłonowych

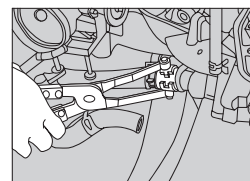

For cooling water pipe
Do przewodów gumowych układu chłodzenia

2
PCS

1/4"-3/4"

6.3-19.0
mm

217
mm

254
mm



SLIDING
CARD



YATO	L (mm)	
YT-0645	217	6/24
	254	

GB Hose clamp pliers
 D Zange zum Entspannen der Klemmschellen
 PL Szczypce do opasek zaciskowych rozprężnych
 RUS Щипцы к хомутам зажимным распорным
 CZ Kleště na samosvorné hadicové spony
 H Vízcsőbilincс fogó

RO Clește pt. benzile de strângere destindere
 F Pince pour collier de serrage
 I Set pinze per il morsetto
 E Pinzas para las abrazaderas de expansión
 CN 管夹钳

SLIDING CARD



215 mm



2 mm



ALLOY STEEL AISI 4130

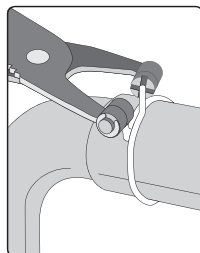

YATO	L (mm)	
YT-0646	215	12/72

GB Hose clamp pliers
 D Zange zum Entspannen der Klemmschellen
 PL Szczypce do opasek zaciskowych rozprężnych
 RUS Щипцы к хомутам зажимным распорным
 CZ Kleště na samosvorné hadicové spony
 H Vízcsőbilincс fogó

RO Clește pt. benzile de strângere destindere
 F Pince pour collier de serrage
 I Set pinze per il morsetto
 E Pinzas para las abrazaderas de expansión
 CN 管夹钳

SLIDING CARD



215 mm



4.5 mm



ALLOY STEEL AISI 4130

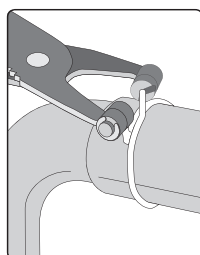

YATO	L (mm)	
YT-0647	215	12/72

GB Hose clamp pliers
 D Zange zum Entspannen der Klemmschellen
 PL Szczypce do opasek zaciskowych rozprężnych
 RUS Щипцы к хомутам зажимным распорным
 CZ Kleště na samosvorné hadicové spony
 H Vízcsőbilincс fogó

RO Clește pt. benzile de strângere destindere
 F Pince pour collier de serrage
 I Set pinze per il morsetto
 E Pinzas para las abrazaderas de expansión
 CN 管夹钳

SLIDING CARD



HRC 40

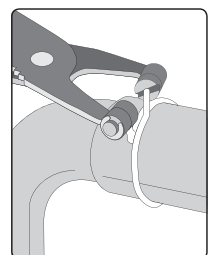

230 mm

YATO	L (mm)	
YT-0650	230	6/36

16



215 mm

YATO	L (mm)	
YT-0651	215	6/36

GB Exhaust pipe clamp pliers
 D Auspuffschellen-Sicherungszange
 PL Szczypce do opasek wydechu
 RUS Щипцы для пружинных зажимов
 CZ Kleště na spony výfuku
 H Kipufogóbilincс fogó

RO Clește pt. coliere teava de esapament
 F Pince pour collier d'échappement
 I Set pinze per il morsetto
 E Pinzas para bridas del tubo de escape
 CN 排气管夹钳

SLIDING CARD



300 mm

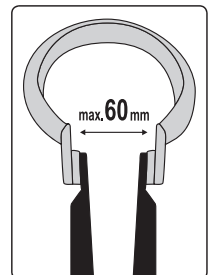

YATO	L (mm)	
YT-0652	300	20/40

for / dla: Peugeot, Citroën,
 Renault, Fiat, Ford

- GB Valve stem seal pliers
D Lange Zange für Ventildichtringe
PL Szczypce do uszczelniaaczy zaworowych, długie
RUS Щипцы для замены маслоъемных колпачков
CZ Kleště na těsnění ventilů, dlouhé
H Szelepszár szimering fogó hosszú

- RO Clește cu picior lung pt. sigilat supape
F Pince pour joints de queues de soupapes
I Pinza per tenuta anello stelo valvola
E Pinzas para juntas de vástago válvula
CN 气门油封钳

SLIDING
CARD



270
mm

FOR VALVE
STEM SEALS
DO USZCZELNIACZY
ZAWOROWYCH

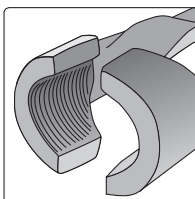

NON-SLIP



YATO	L (mm)	
YT-0648	270	12/60

- GB Pliers for band clips with a cord
D Zange für Rohrschellen mit Seil
PL Szczypce z linką do opasek zaciskowych
RUS Щипцы к зажимным хомутом с тросиком
CZ Kleště s lankem na samosvorné
hadicové spony
H Flexibilis bowdenes vízcsőbilincz fogó
RO Clește pt. cleme de prindere frânghie

- F Pince pour collier de serrage
I Pinza per il montaggio e lo smontaggio
delle clips elastiche
E Pinzas para bandas de apretadura
con cuerda
CN 延长型弹性管夹钳

SLIDING
CARD



CrMo
4140

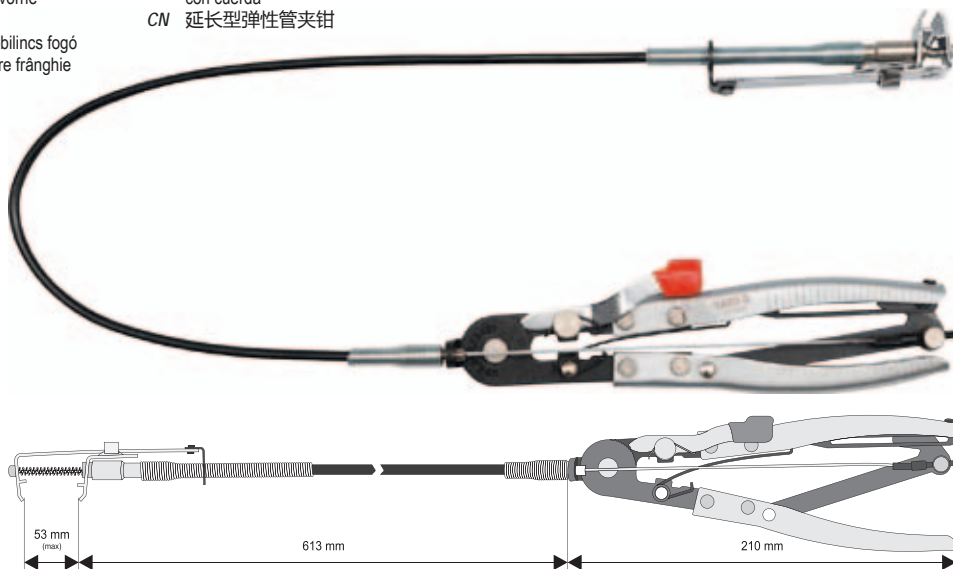

YATO		
YT-0653		12/36

- GB Pliers for band clips with a cord
D Zange für Rohrschellen mit Seil
PL Szczypce z linką do opasek zaciskowych
RUS Щипцы к зажимным хомутом с тросиком
CZ Kleště s lankem na samosvorné
hadicové spony
H Flexibilis bowdenes vízcsőbilincz fogó
RO Clește pt. cleme de prindere frânghie
F Pince pour collier de serrage
I Pinza per il montaggio
e lo smontaggio
delle clips elastiche
E Pinzas para bandas
de apretadura con cuerda
CN 延长型弹性管夹钳

SLIDING
CARD



CrMo
4140

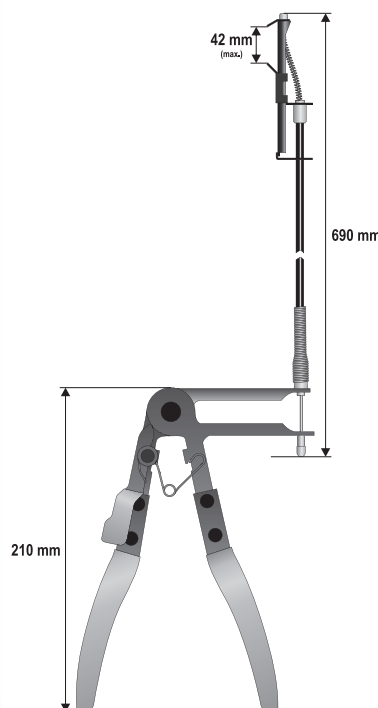

YATO		
YT-0677		25

- GB Hose clip pliers
 D Schlauchklemmzange
 PL Szczypce do opasek zaciskowych typu CLIC i CLIC-R
 RUS Плоскогубцы для зажима шлангов хомуты, CLIC-R
 CZ Kleště na hadicové spony
 H Tömlőbilincsz fogó
 RO Cleste furturn clip
 F Pince pour collier de serrage
 I Pinza per fascetta a CLIC e CLIC-R
 E Alicates abrazaderas
 CN 压线钳



SLIDING CARD



170 mm

CLIC CLIC-R

YATO	L (mm)	
YT-06475	170	15/60

- GB Water pump pulley locking wrench
 D Schlüssel für die Wasserpumpe
 PL Klucz do pompy wodnej
 RUS Ключ к водному насосу
 CZ Klič na vodní čerpadlo
 H Vízpumpafogó
- RO Cheie pt. pompe de apă
 F Clé de blocage pour pompe à eau
 I Chiave per la pompa del acqua
 E Llave para la bomba de agua
 CN 水泵皮带轮扳手

SLIDING CARD



245 mm

285 mm

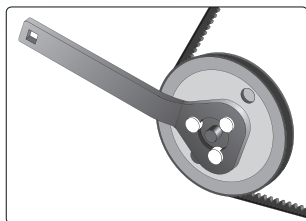

Volkswagen and Audi without air condition
 Volkswagen i Audi bez klimatyzacji

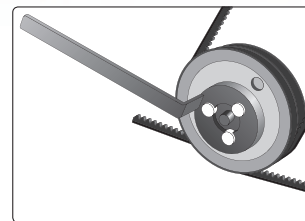

Volkswagen and Audi with air condition
 Volkswagen i Audi z klimatyzacją

YATO	L (mm)	
YT-0539	245	6/36

YATO	L (mm)	
YT-0540	285	6/36

- GB Tensioner pulley wrench
 D Zahnriemen Spannrollenschlüssel
 PL Klucz do rolki napinającej
 RUS Ключ для регулировки натяжного
- CZ Klič na napínák
 H Bordás szij feszítő
 RO Cheie de pretensionare a centurilor
 F Clé pour rouleau de tension
- I Chiave per il rullo tenditore
 E Llave del tensor de la correa dentada
 CN 滑轮定时扳手

SLIDING CARD



32 mm



YATO	
YT-06273	20/100

16

- GB Universal pulley holder & fan clutch set
 D Schlüssel zum Spannen der Riemenscheibe
 PL Klucz do napinania koła pasowego
 RUS Ключ для натягивания шкива
 CZ Klič k napínání řemenice
 H Szíjtárcsa feszítő kulcs
 RO Cheie pt. întindere roată de curea
 F Clé universelle pour poulie
 I Blocca puleggia
 E Llave tensora para polea
 CN 多用式皮带轮扳手



11 PCS

BMC & COLOR SLEEVE

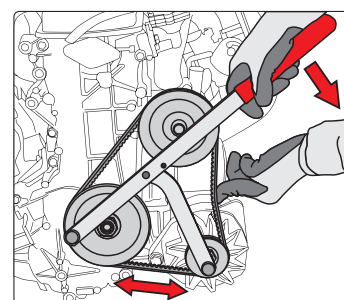

Ø 6-10 mm; Ø 8-11 mm;
 Ø 10-12 mm; Ø 11-16 mm

YATO	
YT-0627	6

- GB Piston ring compressor
D Kolbenring-Spannband
PL Zaciskacz do pierścieni
RUS Оправка поршневых колец
CZ Svěrka na kroužky
- H Gyűrűbepattintó
RO Clește pt. strâns inele
F Compresseur de segments de piston
I Morsetto per anelli

- E Apertador de anillos
CN 活塞环压缩机

AISI # 301 SK5

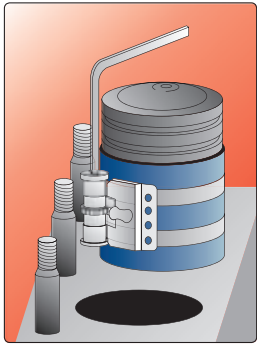

COLOR BOX

YATO	Ø (mm)	H (mm)	
YT-0635	50-125	75	30/60
YT-0636	90-175	100	30/60
YT-0637	90-175	150	20/40

- GB Belt gauge
D Werkzeug Spannungsprüfer
PL Przyrząd do kontroli naciągu paska rozrządu
RUS Прибор для проверки натяжения ремней
CZ Přístroj pro kontrolu napnutí rozvodového řemene
- H Méter szíjfeszességét
RO Tester intindere curea de distributie cu gradatie
F Controleur de tension de courroie
I Strumento per il controllo rapido della tensione cinghia distribuzione
E Medidor para determinar la tensión de la correa
CN 皮带张紧器

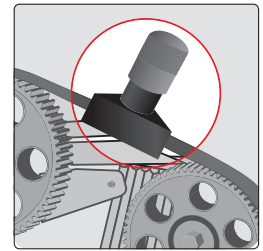

COLOR BOX

YATO	
YT-06019	20

- GB Twin cam locking tool for petrol & diesel engines
D Universelle Blockade der Steuerrollen
PL Uniwersalna blokada wałków rozrządu
RUS Универсальный набор блокировки распределителя
CZ Univerzální přípravek na zablokování rozvodných hřídelí
H Univerzális vezérműtengely rögzítő

- RO Blocadă universală arbore de direcție
F Outil de blocage d'arbre à cames
I Universale strumento di bloccaggio a camme
E Bloqueo universal de eje de distribución
CN 双凸齿轮固定器

FOR PETROL & DIESEL ENGINES
DO SILNIKÓW DIESLA I BENZYNOWYCH

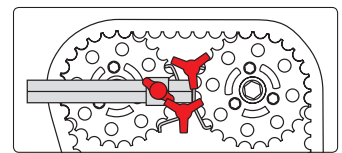

SLIDING CARD

YATO	
YT-06011	10/20

- GB Camshaft locking tool
D Nockenwellen-Arretierwerkzeug
PL Przyrząd do blokowania kół rozrządu
RUS Инструмент для блокирования распределительных механизмов
CZ Přípravek k montáži rozvodových kol
H Vezérlés rögzítő szerszám
RO Arbore cu came
F Outil de blocage d'arbre à cames
I Set di serrature di temporizzazione
E Aparato para bloquear el árbol de levas
CN 正时皮带固定器

SLIDING CARD



48 mm

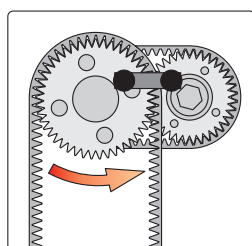

- VW Lupo since 1999
VW Polo since 1995
VW Caddy since 1996
VW Polo Classic since 1996
- VW Polo Variant since 1996
VW New Beetle 1.4 l
VW Golf 1.4 l, 1.6 l since 1998
VW Bora 1.4 l, 1.6 l since 1999

YATO	
YT-0601	6/36

- GB Diesel engine locking setting kit
D Blockade für die Steuerräder
PL Blokada do kół rozrządu
RUS Блокировка к колесам распределительных механизмов
CZ Souprava na fixaci rozvodových kol
H Diesel motor rögzítő készlet

- RO Blocadă roților distribuție
F Outil de blocage d'arbre à cames
I Cinghia di distribuzione di bloccaggio
E Bloqueo para las poleas del mecanismo de distribución
CN 正时皮带更换工具

3 PCS

FOR VALVETRAIN DO UKLADU ROZRZADU

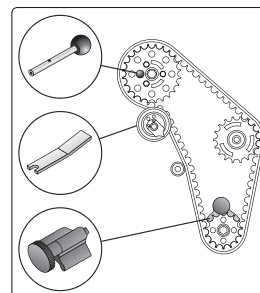

- SEAT: Arosa, Ibiza, Cordoba, Leon, Toledo, Alhambra (1999-2005);
SKODA: Fabia, Octavia (2000-2006)
3 i 4 cyl 1.2, 1.4, 1.9 TDI PD
2.0 SDI, 2.0 TDI PD

SLIDING CARD



YATO	
YT-0632	10/40

GB Timing locking set
 D Arretierwerkzeugsatz für Nockenwellen
 PL Zestaw blokad rozrządu
 RUS Набор блокировок к колесам
 распределительных механизмов
 CZ Blokovací sada pro opravy rozvodů
 H Vezérműrgőztítő szerszámkészlet
 RO Set blocare distributie auto
 F Outil de blocage d'arbre à cames
 I Set di bloccaggio distribuzione auto
 E Juego de bloques de distribución
 CN 正时皮带固定器组套



3
PCS

FOR VALVETRAIN
DO UKŁADU ROZRZĄDU

FOR DIESEL ENGINES
DO SILNIKÓW DIELSA

FOR GASOLINE ENGINES
DO SILNIKÓW BENZYNOWYCH

APPLICATION:
 RENAULT: Twingo, Clio, Kangoo, Megane, Scenic, Laguna, Espace 1.2, 1.4, 1.6, 1.8, 2.0 16v (98-06), 1.5dCi;
 NISSAN: Micra 1.5dCi, Kubistar 1.6 16v (03-06); OPEL: Vivaro 2.0 16v (01-06)

ZASTOSOWANIE:
 RENAULT: Twingo, Clio, Kangoo, Megane, Scenic, Laguna, Espace 1.2, 1.4, 1.6, 1.8, 2.0 16v (98-06), 1.5dCi;
 NISSAN: Micra 1.5dCi, Kubistar 1.6 16v (03-06); OPEL: Vivaro 2.0 16v (01-06)

ENGINE CODES:
 RENAULT: D4F, K4J, K4M, F4P F4R, F4Rt, F5R740, K9K;
 NISSAN: K9K, K4M; OPEL: FR4 720

SILNIKI O KODZIE:
 RENAULT: D4F, K4J, K4M, F4P F4R, F4Rt, F5R740, K9K;
 NISSAN: K9K, K4M; OPEL: FR4 720

BMC
& COLOR
SLEEVE



YATO 	
YT-06014	10

GB Timing locking set
 D Arretierwerkzeugsatz für Nockenwellen
 PL Zestaw blokad rozrządu
 RUS Набор блокировок к колесам
 распределительных механизмов
 CZ Blokovací sada pro opravy rozvodů

H Vezérműrgőztítő szerszámkészlet
 RO Set blocare distributie auto
 F Outil de blocage d'arbre à cames
 I Set di bloccaggio distribuzione auto
 E Juego de bloques de distribución
 CN 正时皮带固定器组套

4
PCS

FOR VALVETRAIN
DO UKŁADU ROZRZĄDU

FOR GASOLINE ENGINES
DO SILNIKÓW BENZYNOWYCH

DROP FORGED KUTE

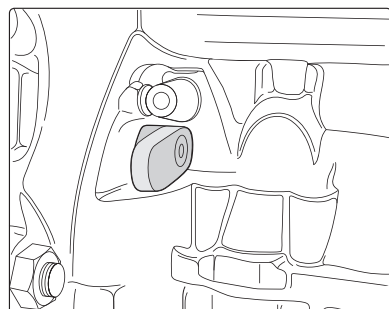
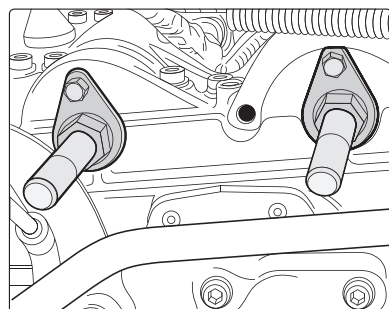

Timing locking set for engines 1.2 6V / 12V (chain)

Zestaw blokad rozrządu silników 1.2 6V / 12V (łańcuch)

APPLICATION:
 VW, SKODA, SEAT 1.2 12V and 1.2 6V (HTP);
 VW: Polo;
 SEAT: Ibiza, Cordoba;
 SKODA: Fabia HTP;
 Engine codes AZQ, AWY, BMD, BME (02-07).

ZASTOSOWANIE:
 VW, SKODA, SEAT 1.2 12V i 1.2 6V (HTP);
 VW: Polo;
 SEAT: Ibiza, Cordoba;
 SKODA: Fabia HTP;
 Silniki o kodzie AZQ, AWY, BMD, BME (02-07).

SET INCLUDES:
 • camshaft locking pin 1 pc
 • crankshaft locking pin 1 pc
 • camshaft locking clamps 2 pcs

ZESTAW ZAWIERA:
 • trzpień blokujący wałek rozrządu 1 szt.
 • trzpień blokujący wał korbowy 1 szt.
 • zacisk blokujący wałki rozrządu 2 szt.



YATO 	
YT-06012	10

- GB Timing locking set
D Arretierwerkzeugsatz für Nockenwellen
PL Zestaw blokad rozrządu
RUS Набор блокировок к колесам распределительных механизмов
CZ Blokovací sada pro opravy rozvodů
H Vezérműrögztítő szerszámkészlet
RO Set blocare distributie auto
F Outil de blocage d'arbre à cames
I Set di bloccaggio distribuzione auto
E Juego de bloques de distribución
CN 正时皮带固定器组套

APPLICATION:

FIAT: 500, Panda, Punto, Grande Punto, Albea, Linea, Bravo, Brava, Palio, Idea, Weekend, Siena, Stilo, Marea (97-10); LANCIA: Ypsilon, Musa (96-10)

ENGINE CODES:

1.2 16V - 176B9.000, 182B2.000, 188A5.000, 1.4 16V - 843A1.000, 169A3.000, 192B2.000, 198A1.000, 198A4.000, 199A6.000

ZASTOSOWANIE:

FIAT: 500, Panda, Punto, Grande Punto, Albea, Linea, Bravo, Brava, Palio, Idea, Weekend, Siena, Stilo, Marea (97-10); LANCIA: Ypsilon, Musa (96-10)

SILNIKI O KODZIE:

1.2 16V - 176B9.000, 182B2.000, 188A5.000, 1.4 16V - 843A1.000, 169A3.000, 192B2.000, 198A1.000, 198A4.000, 199A6.000



5
PCS

FOR VALVETRAIN
DO UKŁADU
ROZRZĄDU

FOR GASOLINE
ENGINES
DO SILNIKÓW
BENZYNOWYCH

BMC
& COLOR
SLEEVE



YATO

YT-06016



10

- GB Timing locking set
D Arretierwerkzeugsatz für Nockenwellen
PL Zestaw blokad rozrządu
RUS Набор блокировок к колесам распределительных механизмов
CZ Blokovací sada pro opravy rozvodů
H Vezérműrögztítő szerszámkészlet
RO Set blocare distributie auto
F Outil de blocage d'arbre à cames
I Set di bloccaggio distribuzione auto
E Juego de bloques de distribución
CN 正时皮带固定器组套

APPLICATION:

OPEL: Astra, Vectra, Signum, Zafira, 1.9 CDTi (04 - 06);

FIAT: 1.9, 2.4 JTD; 16v, 20v;

ALFA ROMEO: 147, 156, GT 1.9 JTD 16v, 2.4 JTD 20v

ENGINE CODES:

OPEL: Z19DTH, Z19DT;

ALFA ROMEO : 192 A5.000, 192 B1.000, 937 A4.000, 937 A5.000

ZASTOSOWANIE:

OPEL: Astra, Vectra, Signum, Zafira, 1.9 CDTi (04 - 06);

FIAT: 1.9, 2.4 JTD; 16v, 20v.; ALFA ROMEO: 147, 156, GT 1.9 JTD 16v, 2.4 JTD 20v

SILNIKI O KODZIE:

OPEL: Z19DTH, Z19DT; ALFA ROMEO : 192 A5.000, 192 B1.000, 937 A4.000, 937 A5.000



6
PCS

FOR VALVETRAIN
DO UKŁADU
ROZRZĄDU

FOR DIESEL
ENGINES
DO SILNIKÓW
DIELA

BMC
& COLOR
SLEEVE



YATO

YT-06013



10

- GB Timing locking set
D Arretierwerkzeugsatz für Nockenwellen
PL Zestaw blokad rozrządu
RUS Набор блокировок к колесам распределительных механизмов
CZ Blokovací sada pro opravy rozvodů
H Vezérműrögztítő szerszámkészlet
RO Set blocare distributie auto
F Outil de blocage d'arbre à cames
I Set di bloccaggio distribuzione auto
E Juego de bloques de distribución
CN 正时皮带固定器组套







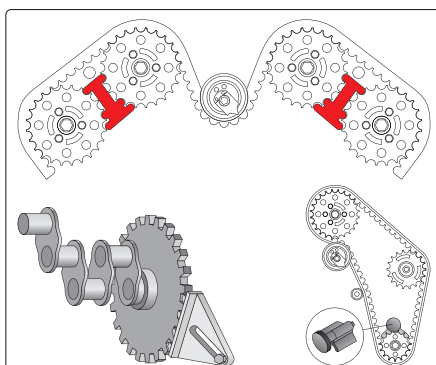

8
PCS

AI

BMC
& COLOR
SLEEVE



YATO	No.	No.	
	 Vauxhall/Opel: ASTRA G 1.7 TD, ASTRA G 2.0 16V, VECTRA 1.8/2.0 16V > 1995		Volkswagen: BORA 1.9TDI, GOLF 1.9TDI, LUPO 1.2/1.4/3.0 TDI, POLO 1.4TDI PASSAT 1.9TDI
	 Vauxhall/Opel: ASTRA G 1.4/1.6/1.8 16V > 1994, VECTRA 1.6/1.8 16V, ZAFIRA 1.6/1.8 16V		Citroen: BERLINGO 1.9D, DISPATCH 1.9D/TF-SO 1.9D, RELAY 1.9D/TD, SYNERGIE 1.9/2.0T, SANTIA 1.9/2.0 D/TD/HDI, XSARA 1.9/2.0 D/HDI, ZX 1.9D/TD, most diesels Fiat: DUCATO 2.0D, ULYSSE 1.8/2.0 TURBO Ford: most diesels Peugeot: 205 1.6/1.8/1.9D, 305 1.6/1.8/1.9D, 306 1.8/1.9D/TD, 309 1.6/1.9D-4.5 1.6/1.9D, 406 1.9D, 605 2.0D/TD, 806 1.9TD, BOXER 1.9/2.0 D/TD, EXPERT 1.9D, PARTNER 1.9D Talbot: EXPRESS D, HORIZON D-J5 D, SOLARA D
YT-0633	 right hand camshaft Saab: 900-9000 Vauxhall/Opel: CALIBRA 2.5/2.5i/2.6 V6, CAVALIER 2.5i V6, OMEGA B 2.5/2.6/3.0/3.2 V6, SINTRA 3.0 V6, VECTRA A 2.5i/2.6 V6		Isuzu: 1.5/1.7 diesel engines Vauxhall/Opel: 1.6/1.7 diesel engines, 1.2/1.4/1.6/1.8/2.0 OHC petrol engines
	 left hand camshaft Saab: 900-9000 Vauxhall/Opel: CALIBRA 2.5/2.5i/2.6 V6, CAVALIER 2.5i V6, OMEGA B 2.5/2.6/3.0/3.2 V6, SINTRA 3.0 V6, VECTRA A 2.5i/2.6 V6		
	 Rover: 25 1.4/1.6/1.8/VVC, 45 1.4/1.6/1.8, 75 1.8, 200 VI, 214 16V, 216 16V/CABRIO/COUPE, 218 COUPE, 414 16V, 416 16V, BRM 1.8VVC		

GB Timing locking set for V.A.G.
D Einstellwerkzeug Zahnriemen nockenwellen
 Arretierwerkzeug steuerriemen für V.A.G.
PL Zestaw blokad rozrządu dla V.A.G.
RUS Набор блокировок газораспределения V.A.G.

CZ Sada aretacie rozvodov pro V.A.G.
H Vezérműrogzító szerszámkészlet mert V.A.G.
RO Set blocare distributie auto pt. V.A.G.
F Outil de blocage d'arbre à cames

I Set di bloccaggio distribuzione auto
E Juego de bloques de distribución para V.A.G.
CN 大众&奥迪正时工具

34
PCS

FOR / DLA
V.A.G.

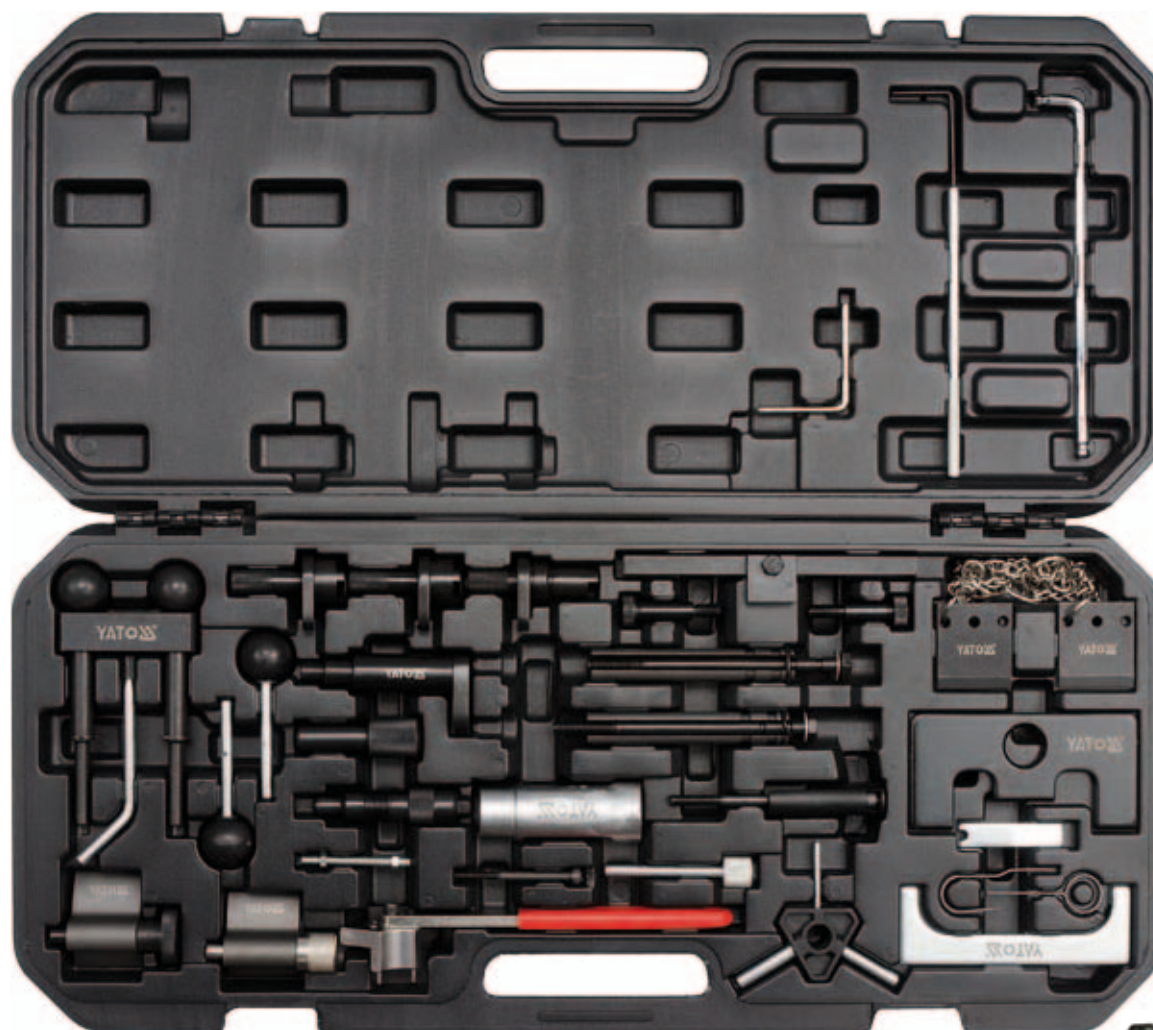

BMC
& COLOR
SLEEVE

YATO 	
YT-06015	4

16

GB Timing locking set for V.A.G.
D Einstellwerkzeug Zahnriemen nockenwellen
 Arretierwerkzeug steuerriemen für V.A.G.
PL Zestaw blokad rozrządu dla V.A.G.
RUS Набор блокировок газораспределения V.A.G.
CZ Sada aretacie rozvodov pro V.A.G.
H Vezérműrogzító szerszámkészlet mert V.A.G.
RO Set blocare distributie auto pt. V.A.G.
F Outil de blocage d'arbre à cames
I Set di bloccaggio distribuzione auto
E Juego de bloques de distribución para V.A.G.
CN 大众&奥迪正时工具



BMC
& COLOR
SLEEVE

4
PCS

FOR VALVETRAIN
DO UKŁADU
ROZRZĄDU

FOR GASOLINE
ENGINES
DO SILNIKÓW
BENZYNOWYCH

APPLICATION / ZASTOSOWANIE:

AUDI: A3 (03-10); SEAT: Altea, Ibiza, Leon;
 SKODA: Fabia II (07-09), Octavia (04-09), Roomster (06-09), Superb (09-10);
 VW: Eos (06-09), Golf (03-09), Golf Plus (05-09), Jetta (06-09), Passat (05-09),
 Polo (02-08), Scirocco (09-10), Tiguan (07-09), Touran (03-09)

ENGINE CODES / SILNIKI:

1.4 FSI: (AXU, BKG, BLN)
 1.4 TFSI: (BLG, BMY, BWK, CAVA, CAVB,
 CAVC, CAVD, CAVF, CAXA, CAXC, CDGA)
 1.6 FSI: (BAG, BLF, BLP, BTS)



YATO 	
YT-06017	10

- GB Wire brush set
- D Bürsten Sortiment
- PL Zestaw szczotek do gniazd wtryskiwaczy
- RUS Ерши с наружной резьбой в наборе
- CZ Rourové kartače válcové
- H Henger drótkefe
- RO Perii cilindrice pt. curatarea gaurilor
- F Brosse cylindrique
- I Vetro di protezione
- E Cepillos para limpieza interior
- CN 件套清洁组

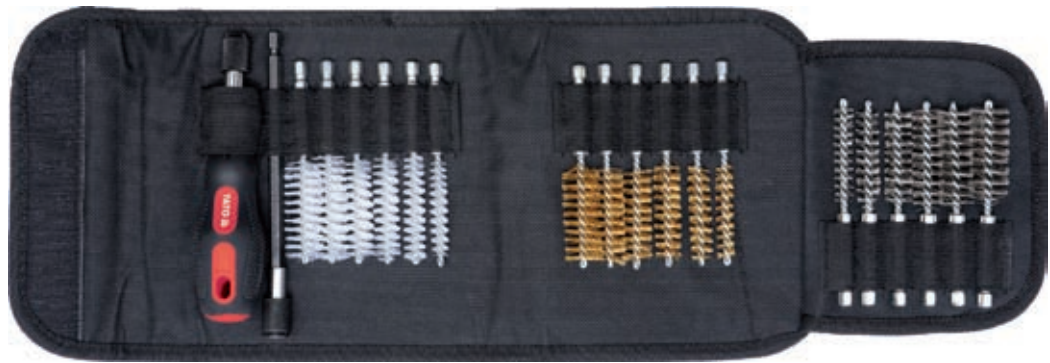
20 PCS	150 mm	1/4" 6.3mm	9,11,13 15,17,19 mm
NYLON	STAINLESS STEEL NERZIEWA	BRASS MOSIADZ	



NYLON CASE
& COLOR BOX

YATO 	
YT-08195	24

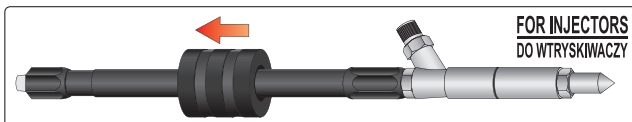

- GB Diesel injector puller
- D Stoßabziehvorrichtung für Einspritzdüse
- PL Ściągacz bezwładnościowy do wtryskiwaczy
- RUS Ударный съемник форсунок
- CZ Rázový vytahovač vstřikovačů
- H Diesel porlasztó kieszedő
- RO Dispozitiv de scoas injectoare
- F Extracteur à choc d'injecteurs
- I Martello scorrevole
per la rimozione degli iniettori
- E Tuerca tensora
de impacto para inyectoros
- CN 柴油喷嘴拔取器

BOSCH TYPE	LUCAS TYPE	M8 M12 M14
---------------	---------------	------------------



BMC
& COLOR
SLEEVE



YATO 	
YT-0617	20

- GB Overhead valve spring compressor
- D Vorrichtung zur Demontage von Motorventilen
- PL Przyrząd do demontażu zaworów silnikowych
- RUS Устройство для демонтажа клапанов двигателя
- CZ Přípravek na demontáž ventilů motoru
- H Szeleplehúzó készülék
- RO Dispozitiv pt. demontarea supapelor la motoare
- F Outil pour démonter les soupapes de moteur
- I Strumento per la rimozione di valvole motore
- E Instrumento para desmontaje de válvulas de motor
- CN 下压式凡尔钳

SLIDING
CARD

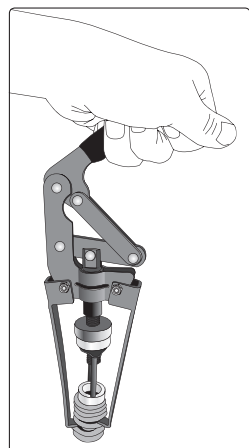

YATO 	
YT-0618	5/25

- GB Lambda sensor thread chaser
 D Lambdasonde gewinde reparatur-set
 PL Zestaw do naprawy gwintów sondy lambda
 RUS Набор для ремонта сорванной резьбы винтов
 CZ Sada na opravu závitu Lambda sondy
 H Menejavitó készlet Lambda szondához
 RO Dispozitiv pt. curatat filet sonda lambda
 F Set de réparation filetage de sonde lambda
 I Chiavi a bussola per sonda lambda
 E Cazador del hilo de rosca para sonda lambda
 CN 火星塞丝攻组套

FOR OXYGEN SENSOR DO SONDY LAMBDA
HRC 50
M12 x 1.25 **M18 x 1.5**



SLIDING CARD

YATO	
YT-1756	12/96

- GB Oxygen sensor crowfoot wrench
 D Schlüssel für die Lambdasonde
 PL Klucz do sondy lambda
 RUS Ключ для зонда lambda
 CZ Klič na sondu lambda
 H Lambda szonda kulcs
 RO Cheie pt. sonda lambda
 F Clé pour sonde lambda
 I Chiave per sonde lambda
 E Llave para la sonda lambda
 CN 氧传感器套筒扳手

SLIDING CARD



22 mm
 FOR OXYGEN SENSOR DO SONDY LAMBDA



CrMo SCM-440

YATO	
YT-1753	30/60



CrV 50BV30

YATO	
YT-1754	6/36

- GB Socket and oxygen sensor set
 D Steckschlüssel für die Lambda-Sonde
 PL Klucze nasadowe do sondy lambda
 RUS Торцовые ключи с внутренним многогранником для зонда lambda
 CZ Nástrčné kľiče na sondy lambda
 H Dugókulcs lambda szondához
 RO Prize pt. sonda lambda
 F Douille pour sonde lambda
 I Set di riparazione per filetti di sonde lambda
 E Llaves de cubo para la sonda lambda
 CN 氧传感器套筒扳手组套

- 22 mm; L=50 mm; 6PT; CrMo SCM440;
 22 mm; L=30 mm; 6PT; CrMo SCM440;
 22 mm; L=80 mm; 6PT; CrV 50BV30



3 PCS **22 mm** FOR OXYGEN SENSOR DO SONDY LAMBDA
CrMo SCM-440 **CrV 50BV30**



YATO	
YT-1752	20

- GB Oxygen sensor and fuel injectors wrench set
 D Steckschlüsselsatz für die Lambdasonde und die Einspritzdüsen
 PL Zestaw nasadek do sondy lambda i wtryskiwaczy
 RUS Набор насадок к лямбда-зондам и форсункам
 CZ Sada nástavců na demontáž sondy lambda a vstříkovačů
 H Dugókészlet lambda szondához és injektorokhoz
 RO Set inelare pt. sonda lambda și injectoare
 F Douilles pour sonde lambda et injecteurs
 I Set di riparazione per filetti di sonde lambda
 E Juego de boquillas para la sonda lambda y para inyectores
 CN 氧传感器套筒扳手组套

- 1/2" (12.7 mm) x 29 mm; L=90 mm; 6PT;
 3/8" (9.5 mm) x 22 mm; L=90 mm; 6PT;
 1/2" (12.7 mm) x 27 mm; L=78 mm; 12PT;
 3/8" (9.5 mm) x 27 mm; L=74 mm; 6PT;
 3/8" (9.5 mm) x 22 mm; L=80 mm; 6PT;
 1/2" (12.7 mm) x 22 mm; L=50 mm; 6PT;
 3/8" (9.5 mm) x 22 mm; L=30 mm; 6PT



7 PCS **1/2" 12.5mm** **3/8" 10mm** FOR OXYGEN SENSOR DO SONDY LAMBDA
CrMo SCM-440 **CrV 50BV30**
 FOR FUEL INJECTORS DO WTRYSKÓW PALIWA



BMC & COLOR SLEEVE

YATO	size / rozmiar	
YT-1751	1/2" (12.7 mm) 3/8" (9.5 mm)	5

- GB** Diesel injection socket set
D Aufsätze für die Einspritzungen bei Dieselmotoren
PL Zestaw nasadek do wtrysków w silnikach Diesla
RUS Набор насадок к форсункам в дизельных двигателях
CZ Sada nástavců na trysky dieselových motorů
H Szerszámkészlet Dieselmotor befecskendezőkhöz
RO Set de capete pt. injectoare în motoare Diesel
F Set des douilles pour injecteurs (diesel)
I Set di custodie per i motori diesel
E Juego de tapones para las inyecciones en los motores de Diesel
CN 柴油机喷油嘴套筒组套



6 PCS	1/2" 12.5mm	AS-DRIVE	CrV
FOR FUEL INJECTORS DO WTRYSKÓW PALIWA			

BMC
& COLOR
SLEEVE



21x90; 22x78; 22x110; 27x78; 28x78; 28x83 mm

YATO	size / rozmiar	
YT-0622	1/2" (12.7 mm)	10

- GB** Diesel injector and cutter set
D Fräsersatz für die Buchsen der Einspritzdüsen
PL Zestaw frezów do gniazd wtryskiwaczy common rail
RUS Комплект фрез для гнезд сопел форсунок
CZ Sada fréz na sedla trysek vstříkovačů
H Marókészlet befecskendező fúvókájának fészkehez
RO Set de freze pt. socluri de duze injectoare
F Alimentation d'un injecteur de common rail
I Set frese per sedi iniettori common rail
E Juego de fresas para el asiento de toberas de inyectoros
CN 7件套气门较刀

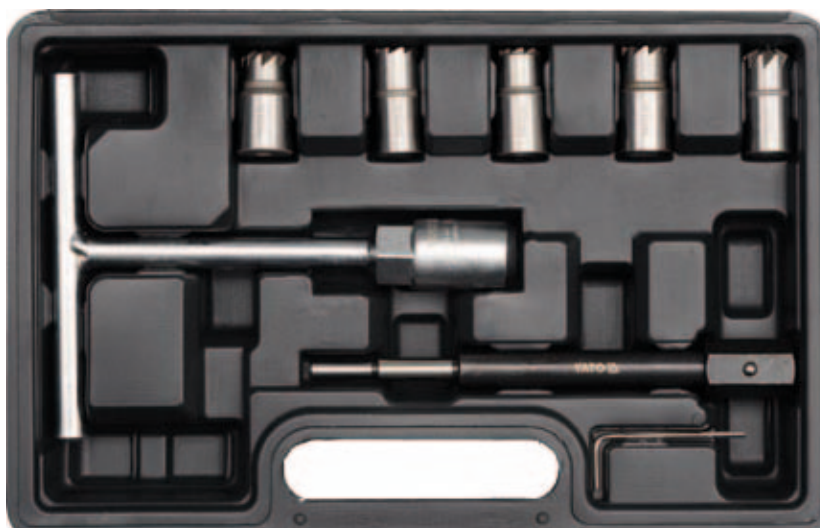

7
PCS

CrMoV
SKD11

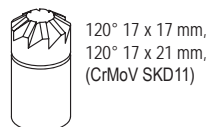
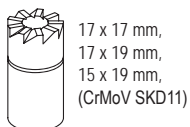
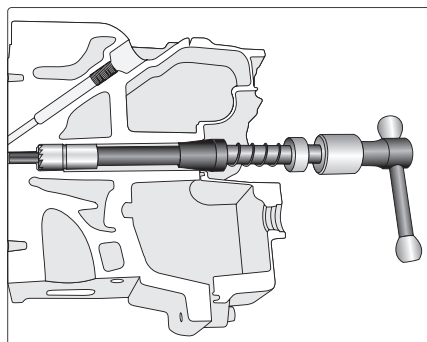

BMC
& COLOR
SLEEVE



YATO	
YT-17625	10

- GB** Tooth socket for injection nozzle
D Stiftschlüsselsatz für die Einspritzdüse in Lastkraftwagen
PL Zestaw kluczy czopowych do wtryskiwaczy w samochodach ciężarowych
RUS Набор шиповых ключей к форсункам грузовых автомобилей
CZ Sada klíčů na vstříkovače pro nákladní automobily
H Csapokulcs készlet tehergépkocsik befecskendezőjéhez
RO Set chei tubulare cu ungere pt. camioane
F Set de douilles injecteurs
I Set di chiavi per iniettori camion
E Juego de llaves de muñón para los inyectoros en camiones
CN 卡车喷油嘴套筒组套



4
PCS

1/2"
12.5mm

HEX

CrMo S45C CrV

FOR FUEL INJECTORS
DO WTRYSKÓW PALIWA

1/2" (12.7 mm); L=72 mm; 4T; CrV;

32 mm; M14 x 1.5 mm; L=70 mm, 4T; S45C;

1/2" (12.7 mm); L=120 mm; 3T; CrMo;

32 mm; L=120 mm, 4T; S45C

BMC
& COLOR
SLEEVE



YATO	size / rozmiar	
YT-1762	1/2" (12.7 mm)	16

- GB Fuel injection test kit
- D Diagnosesatz für die Prüfung der Kraftstoffeinspritzung
- PL Zestaw diagnostyczny do wtrysku paliwa
- RUS Пневматический набор к тормозным зажимам
- CZ Souprava k diagnostice vstřikování paliva
- H Diagnosztikai készlet üzemanyag - befecskendőzökhöz
- RO Ansamblu pt. diagnosticarea injectiei combustibilului
- F Kit de test de débit d'injecteur
- I Set diagnostico per iniettori la benzina
- E Juego de herramientas diagnosticas para la inyección de combustible
- CN 燃料注射测试组套

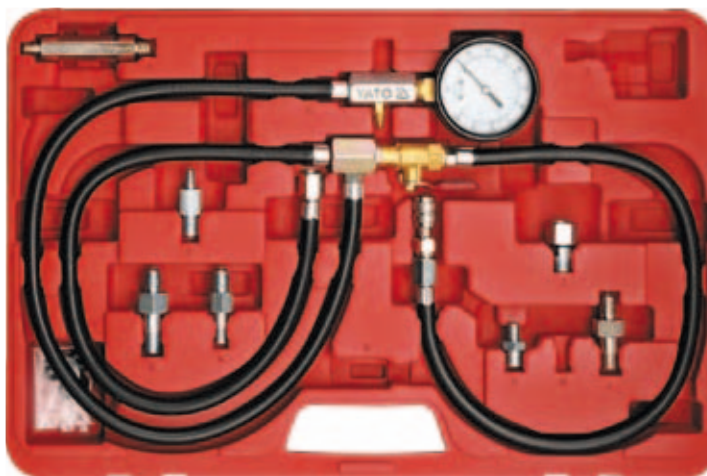

10
PCS
P max.
0.7 MPa

BMC
& COLOR
SLEEVE



YATO	
YT-0670	10

- GB Compression pressure gauge in a diesel engine
- D Kompressionsdruckmesser in Dieselmotoren
- PL Miernik ciśnienia sprężania w silnikach diesla
- RUS Измеритель давления компрессии в дизельных двигателях
- CZ Souprava k měření kompresních tlaků v dieselových motorech
- H Dieselmotorok kompresszióját mérő óra
- RO Manometrul presiunii aerului comprimat pt. motoarele diesel
- F Testeur de pression cylindrique diesel
- I Tester prova compressione motori diesel
- E Medidor de presión de la compresión en los motores diesel
- CN 柴油机压力测试组套

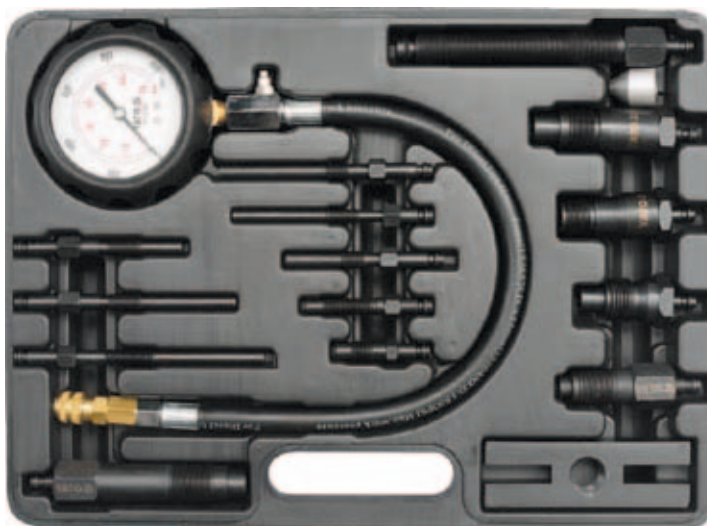

16
PCS
70 bar
max.
FOR DIESEL
ENGINE
DO SILNIKOW
DIESLA

BMC
& COLOR
SLEEVE

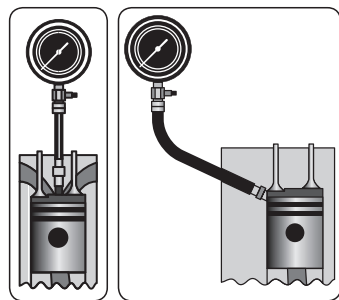

- 70 bar, 500 mm;
- 160 mm;
- M20x1.5: 75 mm; M22x1.5: 73 mm; M24x1.5: 88 mm; M24x2: 63 mm;
- M10x1: 83, 91, 102, 113, 119 mm; M10x1.25: 64, 135 mm; M12x1.25: 47 mm; M22x1.5: 118 mm;

YATO	
YT-7307	5

16

- GB Oil pressure tester
- D Öldruckanzeige
- PL Miernik ciśnienia oleju
- RUS Тестер давления масла с адаптерами
- CZ Tester tlaku oleje
- H Olajnyomásmérő készlet
- RO Tester presiune ulei
- F Set de testeurs de pression d'huile
- I Tester misurazione pressione dell'olio
- E Manómetro de aceite
- CN 自动波箱压力表

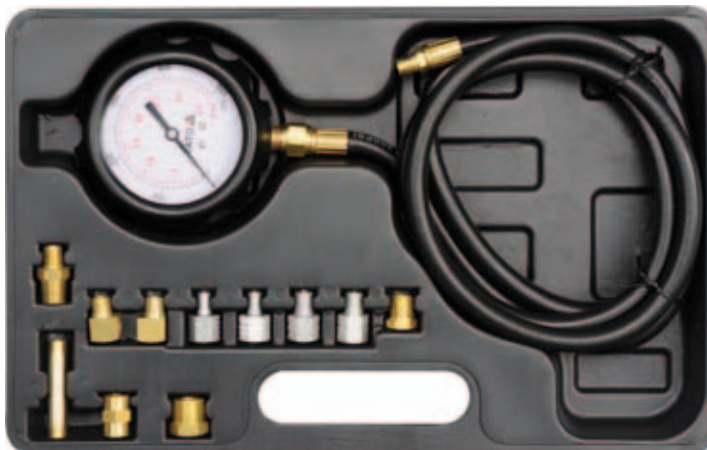

12
PCS
185 cm
HOSE
WAZ
FOR ALL TYPES
OF ENGINES
DO WSZYSTKICH
TYPOW SILNIKOW

0-35 bar
0-500 PSI

BMC
& COLOR
SLEEVE



YATO	
YT-73030	10

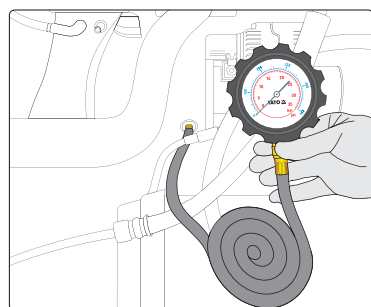

- | | | |
|---------------------------------------|--|--------------------------------|
| GB Compression tester | CZ Měřicí přístroj kompresního tlaku | I Monometro pressione |
| D Druckluftmessgerät | H Kompresszió mérő | E Medidor de compresión |
| PL Miernik ciśnienia sprężania | RO Aparat de măsurarea presiunii | CN 气缸压力表 |
| RUS Тестер компрессии | F Testeur de pression adaptateur cône | |

FOR ALL TYPES
DO WSZYSTKICH TYPOW



21 bar max.

FOR SPARK IGNITION
DO ZAPALONO SKROWEGO

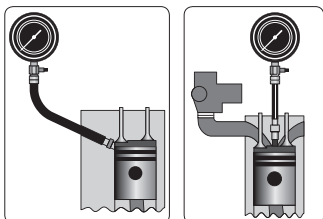

BMC & COLOR SLEEVE

RUBBER ADAPTOR ZŁĄCZE GUMOWE

COLOR BOX



THREADED ADAPTOR ZŁĄCZE GWINTOWANE

COLOR BOX



THREADED ADAPTOR ZŁĄCZE GWINTOWANE

RUBBER ADAPTOR ZŁĄCZE GUMOWE



YATO	
YT-7300	24/48

YATO	
YT-7301	12/24

YATO	
YT-7302	6/24

- | | |
|---|--|
| GB Flow meter common rail adapter set | CZ Souprava na diagnostiku vstřikovačů common rail, průtoková |
| D Überlauf-Diagnosesatz für die Einspritzdüse Common rail | H Diagnosztikai készlet common rail injektorokhoz, átfolyós |
| PL Przelewowy zestaw diagnostyczny do wtryskiwaczy common rail | RO Set diagnostic preaplin pt. injectoare common rail |
| RUS Диагностический набор к форсункам common rail; переливной | F Kit de test de débit d'injecteur common rail |
| CZ Souprava na diagnostiku vstřikovačů common rail, průtoková | I Set controllo portata iniettori common rail |
| H Diagnosztikai készlet common rail injektorokhoz, átfolyós | E Juego diagnóstico de flujo para inyectores common rail |
| RO Set diagnostic preaplin pt. injectoare common rail | CN 柴油燃油喷嘴检测工具 |
| F Kit de test de débit d'injecteur common rail | |
| I Set controllo portata iniettori common rail | |
| E Juego diagnóstico de flujo para inyectores common rail | |
| CN 柴油燃油喷嘴检测工具 | |

31 PCS

FOR 6 CYLINDERS DO 6 CYLINDRÓW



BMC & COLOR SLEEVE

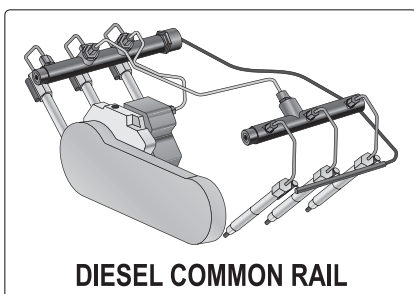

DIESEL COMMON RAIL

YATO	
YT-7306	5

GB Combined sockets for alternator
 D Werkzeugsatz für Lichtmaschine
 PL Zestaw do alternatorów ze sprzęgłem
 RUS Набор для альтернатора
 CZ Souprava na opravu alternátoru
 H Generátor szerszámkészlet
 RO Garnitură pt. alternator

F Set de clés à l'alternateur avec l'embrayage
 I Set di chiavi per smontaggio puleggia e alternatore
 E Enchufes combinados para alternador
 CN 发动机拆卸组套

13 PCS	1/2" 12.5mm	HEX	TORX	SPLINE	CrV
HRC 40-44	S45C	HRC 38-42	STEEL 8660	HRC 53-57	

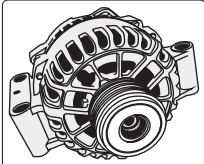

**FOR ALTERNATORS
DO ALTERNATORÓW**

- 1/2" (12.7 mm): M10, HBS, 33T, L=110 mm; CrV; HRC 40-44;
- 1/2" (12.7 mm): T50, HBS, 33T, L=110 mm; CrV; HRC 40-44;
- M8, M10, L=75 mm; 8660; HRC 53-57;
- T40, T50, L=75 mm; 8660; HRC 53-57;
- H8, H10, L=75 mm; 8660; HRC 53-57;
- H15, 33T, L=30 mm; CrV; HRC 40-44;
- H22, 33T, L=30 mm; CrV; HRC 40-44;
- H22, L=30 mm; S45C; HRC 38-42;
- Ø 35 x 30 mm; CrV; HRC 40-44;
- 1/2" (12.7 mm) x 10 mm; CrV; HRC 40-44



YATO	○	
YT-0421	1/2" (12.7 mm)	15

GB Combined sockets for alternator
 D Werkzeugsatz für Lichtmaschine
 PL Zestaw do alternatorów ze sprzęgłem
 RUS Набор для альтернатора
 CZ Souprava na opravu alternátoru
 H Generátor szerszámkészlet
 RO Garnitură pt. alternator

F Set de clés à l'alternateur avec l'embrayage
 I Set di chiavi per smontaggio puleggia e alternatore
 E Enchufes combinados para alternador
 CN 发动机拆卸组套

22 PCS	1/2" 12.5mm	HEX	TORX	SPLINE	CrV
3/8" 10mm	HRC 40-44	S45C	HRC 38-42	STEEL 8660	HRC 53-57

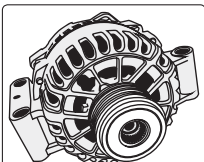
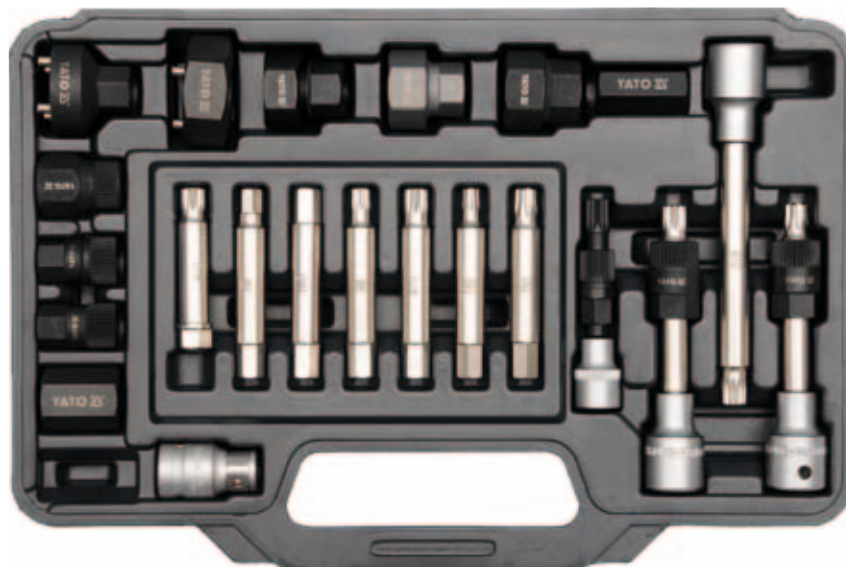

**FOR ALTERNATORS
DO ALTERNATORÓW**

- 1/2" (12.7 mm): M10, HBS, 33T, L=113 mm; CrV; HRC 40-44 / 8660; HRC 53-57;
- 1/2" (12.7 mm): T50, HBS, 33T, L=113 mm; CrV; HRC 40-44 / 8660; HRC 53-57;
- 3/8" (10 mm): M10, HBS, 33T, L=80 mm; CrV; HRC 40-44 / 8660; HRC 53-57;
- 1/2" (12.5 mm): M10; HBS, 33T, L=140 mm; CrV; HRC 40-44;
- M8, M10, L=75 mm; 8660; HRC 53-57;
- T40, T50, L=75 mm; 8660; HRC 53-57;
- H8, H10, L=75 mm; 8660; HRC 53-57;
- M8xH12, L=64 mm; 8660; HRC 53-57;
- H15, 33T, Ø 17 mm, L=30 mm, H15, 33T, Ø 19 mm, L=30 mm, H22, 33T, Ø 19 mm, L=30 mm; CrV; HRC 40-44;
- H17, H22, L=30 mm; S45C; HRC 38-42;
- Ø 35 x 30 mm; S45C; HRC 38-42;
- Ø 38 mm; S45C; HRC 38-42;
- H19x28, H21x28, H22x28; S45C; HRC 38-42;
- 1/2" (12.5 mm) (F) x 10 mm (F); CrV; HRC 40-44



YATO	○	○	
YT-04211	1/2" (12.7 mm)	3/8" (9.5 mm)	5

- GB Stroboscopic tube
- D Stroboskoplampe
- PL Lampa stroboskopowa
- RUS Стробоскопная лампа
- CZ Stroboskopická lampa
- H Stroboszkóp lámpa
- RO Lampă stroboscopică
- F Lampe stroboscopique
- I Lampada stroboscopica
- E Tubo estroboscópico
- CN 点火正时灯

12V

ENGINE SPEED
max. 8000 min⁻¹
max.

XENON

DOUBLE
BLISTER

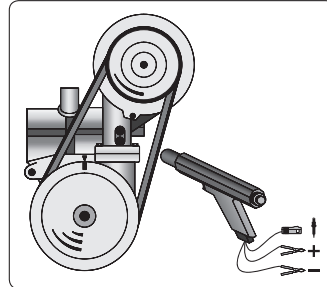

0-60°

YATO		YATO		YATO	
YT-7310	6/12	YT-7311	6/12	YT-7312	6/12

- GB Universal radiator pressure kit
- D Diagnosekit für Kühler
- PL Zestaw diagnostyczny do chłodnicy
- RUS Диагностический набор к радиатору
- CZ Souprava k diagnostice chladiče
- H Diagnosztikai készlet hűtőkhöz

- RO Ansamblu pt. diagnosticarea radiatorului
- F Set diagnostique pour radiateur de voiture
- I Set universale tester pressione del radiatore
- E Juego de herramientas diagnosticas para el radiador
- CN 万用水箱压力测试组套

14
PCS

P max.
0.25 MPa

200°C
max.

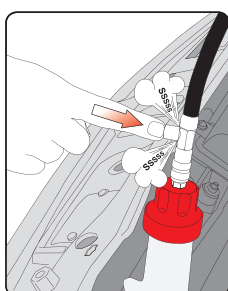
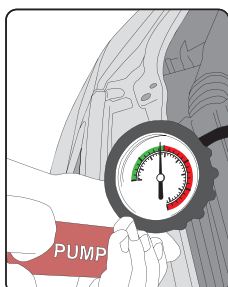
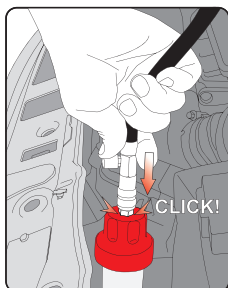

BMC
& COLOR
SLEEVE

YATO	No.			
YT-0672	2		General Motors	
	3		Mercedes, General Motors, Jeep	
	4		Peugeot, Subaru, Chrysler, Acura, General Motors, Mitsubishi, Nissan, Mazda, Toyota, Infiniti, GEO, Suzuki, Isuzu, Ford	
	5		Honda, Toyota, Suzuki, Mitsubishi, Chrysler, Acura	
	6		Audi, BMW, Volkswagen, Porsche	
	7		Volvo, Saab, Citroen, Renault, Fiat, Alfa Romeo, Jeep	
	8		Volkswagen	4
	9		Mercedes, General Motors, Jeep	
	10		BMW	
	11		Audi, Volkswagen	
	12		Ford, Land Rover, Opel, Jaguar, Mercedes	
	13		Mercedes	

- GB Hand-held vacuum pump
- D Unterdruckpumpe mit Zubehör
- PL Pompka podciśnieniowa z akcesoriami
- RUS Насос вакуумметрического давления с принадлежностями
- CZ Podtlaková pumpa s příslušenstvím
- H Vákuum- és ac-pumpa mérő, tartozékokkal
- RO Pompa de vidare cu accesorii
- F Pompe à vide avec les accessoires
- I Pompa a pressione con accessori
- E Bomba de subpresión con accesorios
- CN 手持式真空泵



16
PCS **-1÷0**
bar

BMC
& COLOR
SLEEVE



YATO
YT-0673 10

- GB Hand-held vacuum pump
- D Unterdruck-druckpumpe mit Zubehör
- PL Pompka ciśnieniowo-podciśnieniowa z akcesoriami
- RUS Насос вакуумметрического давления с принадлежностями
- CZ Podtlaková-tlaková pumpa s příslušenstvím
- H Vákuum- és ac-pumpa mérő, tartozékokkal
- RO Pompa de vidare cu accesorii
- F Pompe à vide avec les accessoires
- I Pompa a pressione con accessori
- E Bomba de subpresión-presión con accesorios
- CN 手持式真空泵



22
PCS **-1÷3**
bar

BMC
& COLOR
SLEEVE



YATO
YT-0674 5

16

- GB Flexible line clamp
- D Schlauchklemmsatz
- PL Komplet zacisków do przewodów z cieczą
- RUS Набор зажимов с фиксатором
- CZ Sada hadicových svěrek
- H Flexibilis cső elszorító készlet
- RO Clema flexibila
- F Set de pices pour serrer les
- I Set pinze per chiudere momentaneamente i manicotti
- E Juego de alicates apretadores para conductos de líquidos
- CN 油管封口钳组套

1/4" - 3/4"



1/2" - 5/4"



3/4" - 9/4"

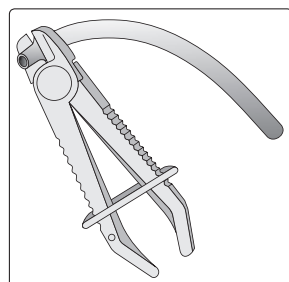

- 1/4" - 3/4" for brake and fuel lines
6.3 - 19.0 mm do przewodów hamulcowych i paliwowych
- 1/2" - 5/4" for flexible hose
12.5 - 32.0 mm do przewodów elastycznych
- 3/4" - 9/4" for radiator hose clamp
19.0 - 57.0 mm do przewodu chłodnicy

3
PCS

WILL NOT CUT HOSES
NIE NSZCZY PRZEWODÓW

NON-CONDUCTIVE
NIEPRZEWODZĄCE



SLIDING
CARD

YATO
YT-0840 25/50

- GB Spark plug socket
D Steckschlüssel mit Gummihalterung
PL Nasadka do świec
RUS Головка свечная
CZ Nastavec pro svíčky
H Gyújtógyertya toldalék
RO Cheie de bujii
F Douille à bougies
I Chiavi a bussola
E Boquilla de bujías
CN 六角火花塞套筒

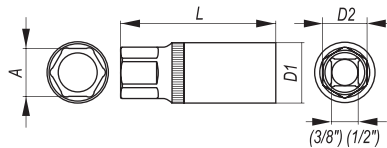

	3/8" 10mm	1/2" 12.5mm
AS-DRIVE	DIN 3121	CrV 50BV30



YATO	Ø	A	D1 (mm)	D2 (mm)	L (mm)	PCS packing	
YT-3851	3/8" (9.5 mm)	16.0	22.0	19.0	64.0	10	50/100
YT-1253	1/2" (12.7 mm)	16.0	22.0	19.0	64.0	10	50/100
YT-1254	1/2" (12.7 mm)	21.0	27.8	24.0	64.0	10	50/100

- GB Spark plug socket
D Kerzenschlüssel mit Verlängerungshebel
PL Klucz do świec z przedłużką
RUS Ключ к свечам с удлинителем

- CZ Klíč na svíčky s prodlužovacím nástavcem
H Gyertyakulcs hosszabbitóval
RO Cheie cu prelungitor, pt. bujii
F Douille à bougies

- I Chiavi per candele a tubo
E Llave para las bujías con extensión
CN 火花塞套筒

3/8" (10 mm) x 300 mm	CrV 50BV30	
--------------------------	---------------	--



YATO	Ø (mm)	
YT-0817	16	10/40
YT-0818	18	10/40
YT-0819	21	10/40

- GB Joined glow plug socket set
D Schlüsselsatz für Glühkerzen
PL Zestaw kluczy do świec żarowych
RUS Набор ключей к калильным свечам
CZ Sada klíčů na žhavicí svíčky
H Gyertyakulcs készlet
RO Set chei pt. bujii incandescente
F Set de douilles à bougies
I Set chiavi a bussola
E Juego de llaves para bujías incandescentes
CN 预热火花塞套筒组套



6 PCS	3/8" 10mm	BLOCKING SYSTEM SYSTEM BLOKOWĄCY
8, 9, 10, 12, 14, 16 mm		
CrV 50BV30		

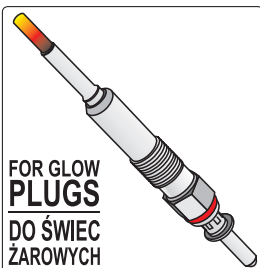

FOR GLOW
PLUGS
DO ŚWIEC
ŻAROWYCH



YATO	Ø	
YT-0534	3/8" (9.5 mm)	10

- GB Torque angle gauge
D Winkelmesser zum Anziehen von Schrauben
PL Kątomierz do dokręcania śrub
RUS Угломер для подвёртывания болтов
CZ Úhloměr k utahování šroubů
H Nyomaték szögmérő
RO Raportor pt. înşurubat şuruburi
F Rapporteur à serrer les vis
I Goniometro per il serraggio controllo
E Calibrador para apretar tornillos
CN 扭力角度规



1/2" 12.5mm	360°	CrV
----------------	------	-----



YATO		
YT-0593		12/48

- GB Metal conduit bender
 D Biegevorrichtung für Metallleitungen
 PL Giętarka do przewodów metalowych
 RUS Гибочный станок для проводов из металла
 CZ Ohýbačka kovových trubek
 H Hajlító fémvezetékekhez

- RO Mașina de indoit (curbat) pt. cabluri metalice
 F Cintreuse au câble de frein
 I Piegatrice per fili metallici
 E Dobladora de tubos de metal
 CN 弯管器

SLIDING CARD



AI



125 mm max. ∅ 6 mm



235 mm max. ∅ 12 mm

YATO	L (mm)	
YT-0813	125	24/96

YATO	L (mm)	
YT-0814	235	6/48

- GB Universal clutch adjustment set
 D Universal-set, um die Kupplungsscheibe einstellen
 PL Zestaw do centrowania tarczy sprzęgłowej
 RUS Комплект для центровки дисков сцепления
 CZ Univerzální sada pro nastavení spojky disk
 H Kuplung központosító készlet
 RO Trusa pt. centrare ambreiaje
 F Centreur d'embrayage
 I Set di centraggio frizione
 E Herramienta alineación embrague
 CN 燭磁動調每漢



9 PCS

∅ mm 11-25



BMC & COLOR SLEEVE

∅ 11, 15, 16.5, 17, 19, 20, 20.5, 25 mm

YATO	
YT-06311	20

- GB Brake retainer spring tool
 D Montagewerkzeug für Bremsfeder
 PL Ściągacz sprężynek szczęk hamulcowych
 RUS Съемник для тормозных пружин
 CZ Stahovač pružin brzdových čelistí
 H Fékrugó szerelő szerszám
 RO Dispozitiv pt. montat arc pe sabot

- F Extracteur de ressorts freins
 I Freno scarpa di fissaggio a molla compressori
 E Herramienta para resorte retenedor de frenos
 CN 刹车弹簧华司拆装器

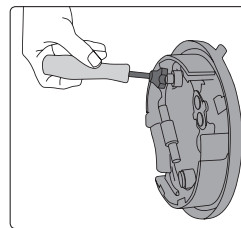

SLIDING CARD



FOR DRUM BRAKES DO HAMULCÓW BĘBNOWYCH



YATO	
YT-0685	12/96

YATO	
YT-0686	12/72

- GB Brake spring pliers kit
 D Bremsbacken-montage set
 PL Zestaw do montażu szczęk hamulcowych
 RUS Набор инструментов для тормозных пружин
 CZ Sada na montáž brzdových čelistí
 H Fogókészlet fékrugóhoz

- RO Dispozitiv pt. inlocuit garnituri cilindrii receptori
 F Set pour le montage des mâchoires de freins
 I Set per montaggio molle freni
 E Juego para resortes de frenos
 CN 刹车拆卸工具组套

3 PCS

FOR DRUM BRAKES DO HAMULCÓW BĘBNOWYCH

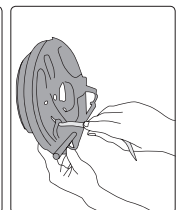
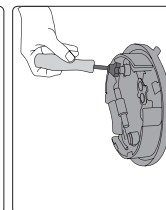
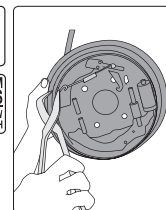

DOUBLE BLISTER



YATO	
YT-0684	6/24

- GB Professional brake tool set
D Werkzeugsatz zum Wechseln der Bremsbacken
PL Zestaw do wymiany szczęk hamulcowych
RUS Набор для замены тормозных колодок
CZ Sada na výměnu brzdových čelistí
H Fékpofa-cserélő készlet
RO Kit pt. înlocuirea sabotilor de frână
F Set pour mâchoires de freins
I Set di regolazione del freno
E Juego para el reemplazo de zapatas de freno
CN 刹车拆卸工具组套



8
PCS

FOR DRUM
BRAKES
DO HAMULCOWY
BĘBNOWYCH

BMC
& COLOR
SLEEVE



YATO
YT-0680

5

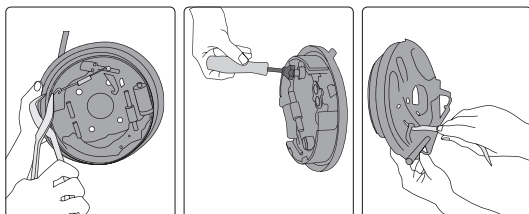

- GB Speedy brake pad compresses
D Ausdrückvorrichtung für Bremskolben
PL Wyciskacz do tłoczków hamulcowych
RUS Приспособление для выдавливания тормозных поршней
CZ Přípravek k zatlačování brzdových pístů
H Fékdugattyú visszanyomó
RO Presă pt. pistoane de frână
F Repousse piston d'étrier de frein
I Arretratore manuale per pistoncini freno
E Expulsor para pistones de frenos
CN 快速刹车片分离器



15-90
mm

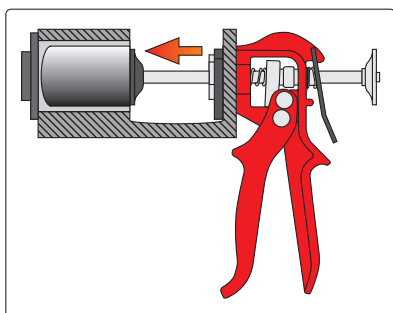

COLOR
BOX



YATO
YT-0604

16

- GB Disc brake spreader
D Scheibenbremsen Abscheider
PL Separator do hamulców tarczowych
RUS Распорка тормозных дисков
CZ Přípravek na montáž brzdových prasátek
H Fékmunkahenger visszanyomó
RO Separator disc ambreiaj
F Séparateur des freins à disque
I Separatore per pistoncini freno
E Separador de frenos de discos
CN 刹车片分离器

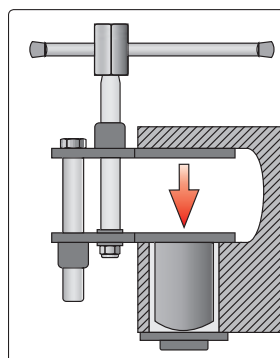

0-65
mm

1/2" (12.5 mm)
21 mm

COLOR BOX



YATO
YT-0610

12/24

- GB Disc brake piston tool
D Bremskolbenrücksteller universal
PL Uniwersalny klucz do wkręcania zacisków hamulcowych
RUS Ключ для тормозного поршня
CZ Univerzální klíč k montáži brzdových třmenů
H Féknyereg összenyomó

- RO Dispozitiv pt. impins etrier
F Clé universelle pour pinces de frein
I Attrezzo per l'arretamento della pinza dei freni
E Llave para comprimir pistones del freno de disco
CN 刹车分泵拆装器



for / dla: GM, FORD, Chrysler, VW, Fiat

3/8"
10mm

CrV

SLIDING
CARD



YATO
YT-0683

12/96

- GB Disc brake pad & caliper service tool kit
- D Werkzeugsatz von manuellen Separatoren für die Bremsklemmen
- PL Zestaw ręcznych separatorów do zacisków hamulcowych
- RUS Набор ручных сепараторов для тормозных зажимов
- CZ Ruční sada na montáž kotoučových brzd
- H Fék munkahenger prés készlet
- RO Set de separatoare manuale pt. etrier frâna
- F Set de repousse piston de frein
- I Kit universale regolazione manuale per pistoni freni
- E Juego de separadores manuales para abrazaderas de freno
- CN 刹车片分离器组套

11
PCS

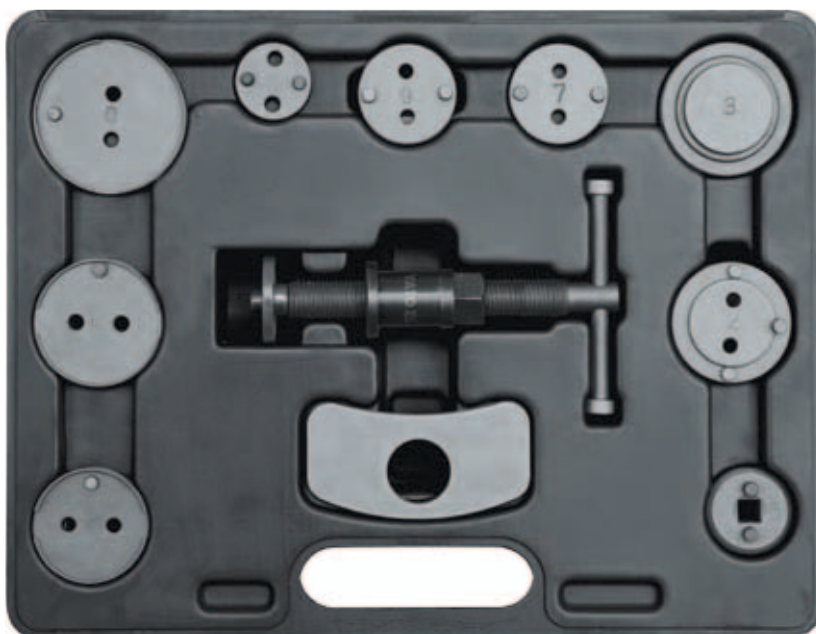

BMC
& COLOR
SLEEVE

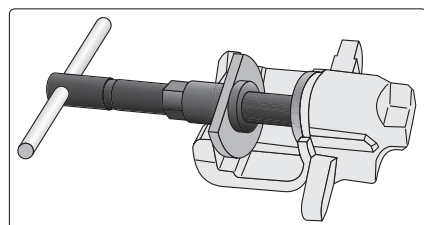

YATO 	No.	zacisk przedni (F)	zacisk tylny (R)	
YT-0681	1-1	siłownik		5
	1	płytkę oporową		
	5	adapter z gniazdem		
	2	Citroen: XM, Xantia		
	3	Alfa Romeo, Audi, Austin, BMW, Honda, Jaguar, MB, Mitsubishi, Nissan, Rover, Toyota, VW		
	4		Ford, Mazda, Subaru, Alfa Romeo, Saab	
	6		Nissan	
	7		Audi, Ford, Honda, Nissan, Rover, Saab, Subaru, VW	
	8	General Motors		
9	General Motors			

- GB Disc brake pad & caliper service tool kit
- D Werkzeugsatz von manuellen Separatoren für die Bremsklemmen
- PL Zestaw ręcznych separatorów do zacisków hamulcowych
- RUS Набор ручных сепараторов для тормозных зажимов
- CZ Ruční sada na montáž kotoučových brzd
- H Fék munkahenger prés készlet
- RO Set de separatoare manuale pt. etrier frâna
- F Set de repousse piston de frein
- I Kit universale regolazione manuale per pistoni freni
- E Juego de separadores manuales para abrazaderas de freno
- CN 刹车片分离器组套

12
PCS

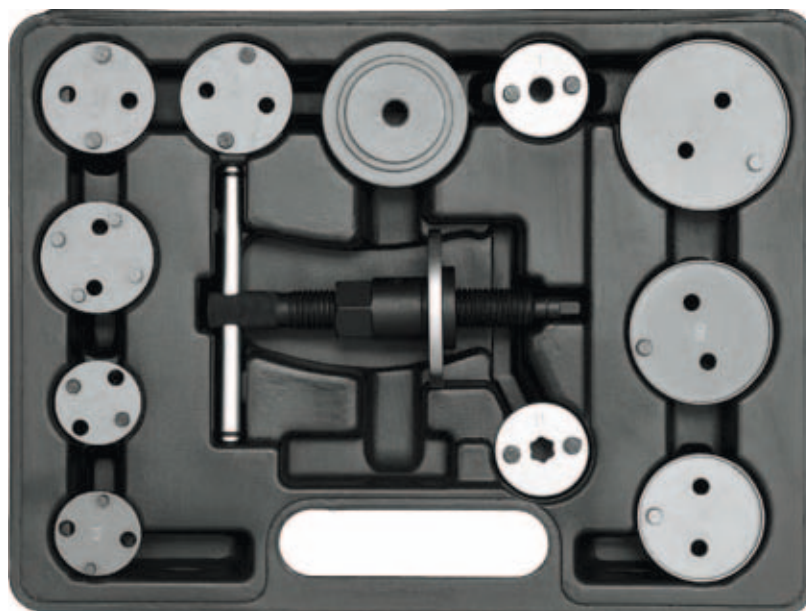

BMC
& COLOR
SLEEVE

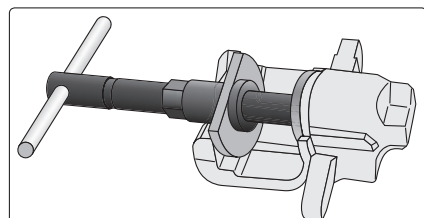

YATO 	No.	zacisk przedni (F)	zacisk tylny (R)	
YT-0611	0	General Motors - zaciski 2 1/2" (63.5 mm)		10
	1	Adapter do przedniego zacisku		
	2	Citroen XM, Xantia (F/R)		
	3		Opel (R)	
	4		Ford (R), Mazda (R), Saab (R), Alfa Romeo 164 2.0 (R), Honda (R), General Motors (R)	
	5	Nissan Maxima		
	6		Nissan Primera, VW Golf IV	
	7	Audi (F), Rover, Subaru (F), Ford (F), Nissan (F), Peugeot (F), Toyota (F), VW (F)		
	8	General Motors - zaciski 1 7/8" (47.6 mm)		
	9	General Motors - zaciski 2 1/8" (54.0 mm)		
	11		Adapter do tylnego zacisku	

- GB Disk brake pad and caliper
- D Pneumatischer Werkzeugsatz für Bremssattelsysteme
- PL Pneumatyczny zestaw do zacisków hamulcowych
- RUS Пневматический набор к тормозным зажимам
- CZ Pneumatická souprava k montáži kotoučových brzd
- H Pneumatikus készlet fék-munkahengerekhez
- RO Ansamblu pneumatic pt. cilindre de frana
- F Set pneumatique aux séparateurs de pinces de frein
- I Kit universale regolazione pneumatico per pistoni freni
- E Juego de herramientas neumaticas para apretadores de frenos
- CN 盘式制动衬块和制动钳

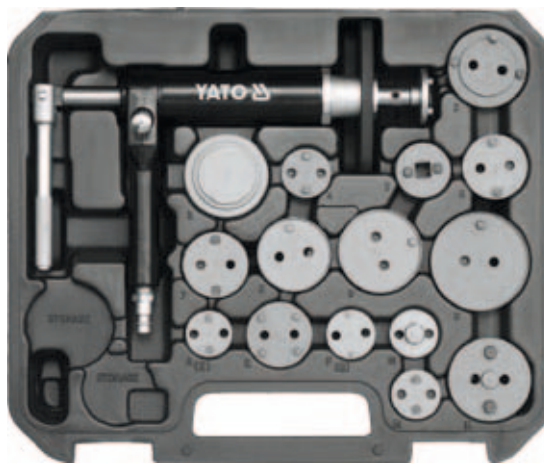
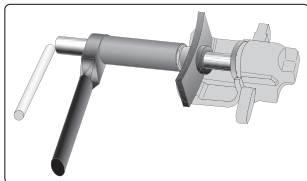

16
PCS

0.75
MPa

1/4"
6.3mm

BMC
& COLOR
SLEEVE



YATO	No.	zacisk przedni (F)	zacisk tylny (R)
YT-0671	0	General Motors - zaciski 2 1/2" (F) (63.5 mm)	
	2		Citroen XM, Xantia (F/R)
	3	Audi (F), Alfa Romeo (F), Fiat (F), Ford Fiesta (F), Isuzu (F), Honda Concerto (F), Jaguar (F/R), BMW (F), Mercedes-Benz (F), Mitsubishi Colt (F), Nissan: Almera, Stanza, Sunny (F), Rover (F), Toyota Camry (F), Volvo (F), VW (F)	
	4		Ford (R), Mazda (R), Saab (R), Alfa Romeo 164 2.0 (R), Honda (R), General Motors (R)
	5		Adapter z gniazdem 3/8"
	6		Nissan Primera (R), VW Golf IV (R)
	7		Audi (R), Rover, Subaru (R), Ford (R), Nissan (R), Peugeot (R), Toyota (R), VW (R)
	8	General Motors - zaciski 1 7/8" (47.6 mm)	
	9	General Motors - zaciski 2 1/8" (54.0 mm)	
	A		Renault (R)
	E		Nissan Maxima (F/R)
	F		Opel (R)
	K		Citroen (R)
	M		Ford (R), Cooper (R)
N		Saab, Honda (F/R)	

- GB Disc brake pad & caliper service tool kit
- D Werkzeugsatz von manuellen Separatoren für die Bremsklappen
- PL Zestaw ręcznych separatorów do zacisków hamulcowych
- RUS Набор ручных сепараторов для тормозных зажимов
- CZ Ruční sada na montáž kotoučových brzd
- H Fékmunkahenger prés készlet
- RO Set de separatoare manuale pt. etrier frâna
- F Set de repousse piston de frein
- I Kit universale regolazione manuale per pistoni freni
- E Juego de separadores manuales para abrazaderas de freno
- CN 刹车片分离器组套

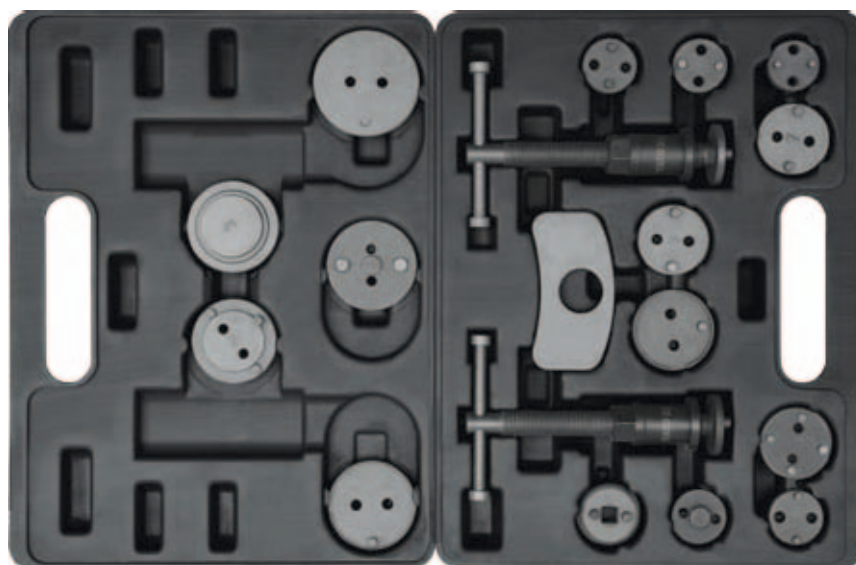
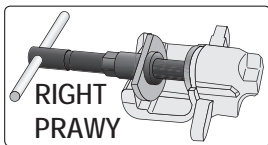
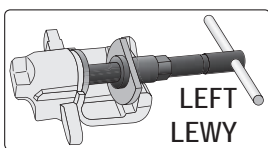

18
PCS

BMC
& COLOR
SLEEVE



YATO	No.	zacisk tylny (R)	zacisk tylny (R)	
YT-0682	1-1		silowniki z lewym i prawym gwintem	
	1		plytka oporowa	
	5	3/8" (10.0 mm)	adapter z gniazdem	
	0	2 1/2" (63.5 mm)	General Motors	
	2	2 1/64" (51.0 mm)	Citroen XM, Xantia	
	3	2 5/32" (55.0 mm)	Audi, Alfa Romeo, Fiat, Ford Fiesta, Honda, Jaguar, BMW, Mercedes, Mitsubishi Colt, Nissan, Rover, Austin, Toyota Camry, Volvo, VW: Passat, Golf GTI	Jaguar
	4	1 1/4" (32.0 mm)		Ford, Mazda, Saab, Alfa Romeo 164, Honda, General Motors
	6	1 21/32" (42.0 mm)		Nissan Primera, VW Golf IV
	7	1 21/32" (42.0 mm)		Audi, Rover, Subaru, Ford, Nissan, Peugeot, Toyota, VW
	8	1 7/8" (48.0 mm)	General Motors	
	9	2 1/8" (54.0 mm)	General Motors, Cadillac	
	E	1 21/32" (42.0 mm)		Nissan Maxima
	F	1 1/4" (32.0 mm)		Opel
	K	2 1/8" (54.0 mm)		Citroen
M	1 1/4" (32.0 mm)		Ford	
N	1 1/4" (32.0 mm)		Saab, Honda	
A	1 3/16" (30.0 mm)		Renault	

- GB Disc brake pad & caliper service tool kit
- D Werkzeugsatz von manuellen Separatoren für die Bremsklappen
- PL Zestaw ręcznych separatorów do zacisków hamulcowych
- RUS Набор ручных сепараторов для тормозных зажимов
- CZ Ruční sada na montáž kotoučových brzd
- H Féknyújtó készlet
- RO Set de separatoare manuale pt. etrier frâna
- F Set de repousse piston de frein
- I Kit universale regolazione manuale per pistoni freni
- E Juego de separadores manuales para abrazaderas de freno
- CN 刹车片分离器组套

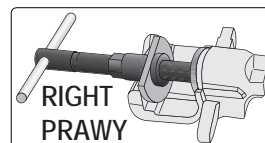
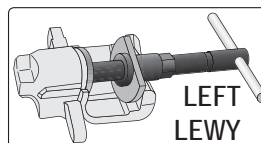

35
PCS
3/8"
10mm

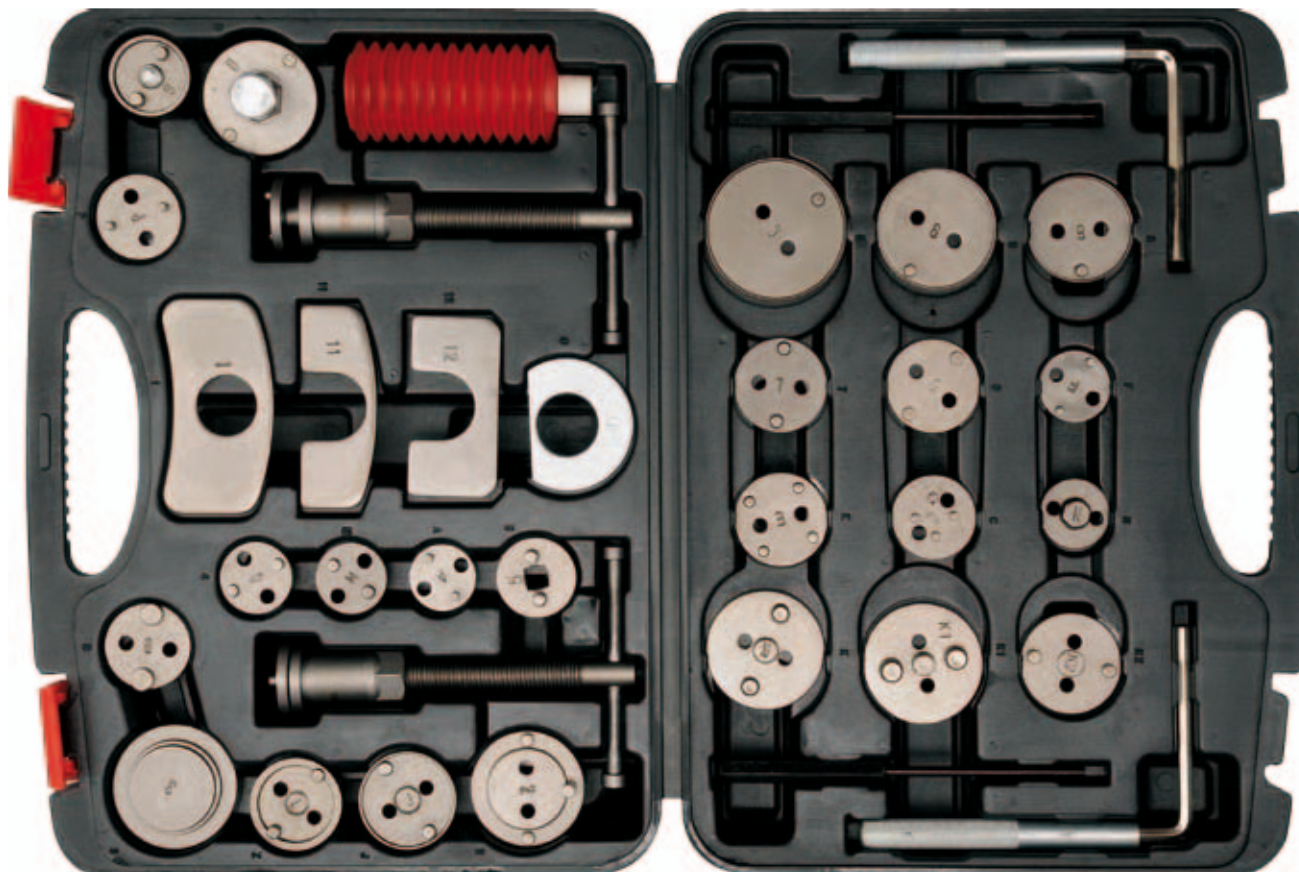

16

No.	No.	zacisk przedni (F)	zacisk tylny (R)
YT-06822	2	2 1/64" (51.0 mm)	Citroen Xantia, Honda Prelude
	3	2 5/32" (55.0 mm)	Fiat, Alfa Romeo, Isuzu, Mercedes Benz, BMW, Citroen, Ford, Honda, Jaguar, Nissan, Peugeot, Rover, Toyota, VAG, Volvo Jaguar
	4	1 1/4" (32.0 mm)	Ford, Mazda, Saab, Fiat, Alfa Romeo, General Motors
	5	3/8" (10.0 mm)	adapter z gniazdem
	7	1 21/32" (42.0 mm)	Nissan, VAG, Jaguar S
	6	1 21/32" (42.0 mm)	Audi, Rover, Subaru, Ford, Nissan, Peugeot, Toyota, VAG, Saab, Jaguar, GM
	8	1 7/8" (48.0 mm)	General Motors
	9	2 1/8" (54.0 mm)	General Motors, Cadillac
	0	2 1/2" (63.5 mm)	General Motors
	A	1 1/5" (30.5 mm)	Renault, BMW, Mini
	B	1 19/30" (41.5 mm)	Ford, Lincoln, Subaru
	C	1 19/30" (41.5 mm)	Mini, Nissan, Opel, Toyota
	D	2 1/64" (51.0 mm)	Renault, Citroen
	E	1 21/32" (42.0 mm)	Nissan Maxima
	F	1 1/4" (32.0 mm)	Opel, Fiat
	G	3/8" (10.0 mm)	Peugeot, GM
	J	1 22/33" (42.5 mm)	Fiat, Alfa Romeo, Audi, Citroen, Renault, Peugeot, Ford, Nissan, Saab, VAG, Subaru, Volvo
	K	2 1/8" (54.0 mm)	Citroen, Opel
	K1	2 1/8" (54.0 mm)	Renault, Citroen
	K2	1 22/33" (50.0 mm)	Citroen, Renault, Audi
P	1 19/30" (41.5 mm)	VAG, BMW, Ford, Lancia, Proton, Renault, Rover, Citroen	
M	1 1/4" (32.0 mm)	Ford, Mini, Nissan	
N	1 1/4" (32.0 mm)	Saab, Honda, Alfa Romeo, Ford Mondeo, Lancia, Volkswagen	
Z	1 3/16" (30.0 mm)	Ford, Mazda, Mitsubishi, Toyota Corolla	
1, 11, 12			plytka oporowa

- GB Coil spring clamp
D Federspanner
PL Ściągacz do sprężyn
RUS Съёмник пружин
CZ Stahovák pružin
tlumičů automobilů
H Rugóösszehűző
- RO Presa pt. arcuiri
F Compresseurs
de ressort
I Estrattore
per smonta molle
E Extractor de muelles
CN 弹簧夹



2
PCS

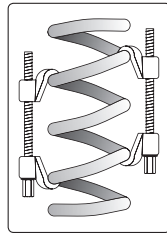
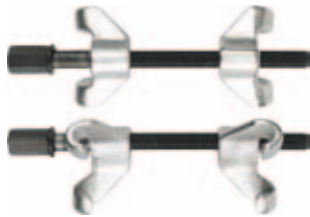

YATO	Ø (mm)	L (mm)	
YT-0605	90	200	5/10

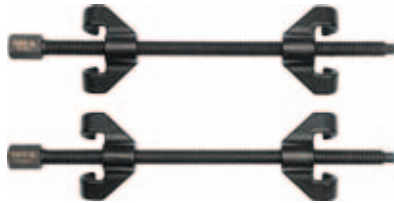

CrV

YATO	Ø (mm)	L (mm)	
YT-2544	82	370	8

COLD FORGED KUTE NA ZIMNO

YATO	Ø (mm)	L (mm)	
YT-2546	82	280	8
YT-2547	82	355	8

- GB Macpherson spring dumper extractor
D Abziehvorrichtung für Federn von MacPherson
PL Ściągacz do sprężyn MacPhersona
RUS Съёмник пружин подвески Макферсона
CZ Stahovák pružin McPherson
H MacPerson rugó összehűző
RO Extractor de arcuiri MacPherson
F Compresseurs de ressort MacPherson
I Estrattore per molle MacPherson
E Desmontador para los resortes de MacPherson
CN 弹簧压缩器

CrMo SCM-415



max. 2900kg

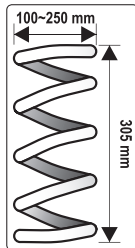

WHITE CARTON BOX & COLOR LABEL

YATO	
YT-2535	2

- GB Vice for shock absorber
D Halterung, Schraubstock für die Säule von MacPherson
PL Uchwyt, imadło do kolumny MacPhersona
RUS Тиски к подвеске Макферсона
CZ Upinací přípravek, svěrák na nápravy McPherson
H Fogantyú, satu MacPerson oszlophoz
RO Mâner, menghină pt. coloana MacPherson
F Poignée et étau pour la colonne MacPherson
I Manico e vice colonna MacPherson
E Mandril, torno para la columna de MacPherson
CN 弹簧避震器固定器

35~70
mm

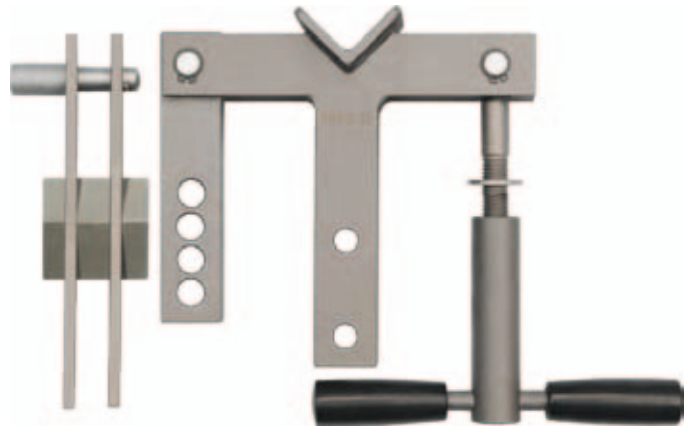

WHITE CARTON BOX & COLOR LABEL

YATO	
YT-2537	5

- GB Interchangeable fork spring compressor and removal tool
D Abziehvorrichtung für MacPherson-Federn mit austauschbaren Halterungen
PL Ściągacz do sprężyn MacPhersona z wymiennymi uchwytami
RUS Стяжка для снятия пружин Макферсона со сменными полукольцами
CZ Stahovák pružin McPherson s výměnitelnými čelistmi
H MacPerson rugó összehűző cserélhető pófakkal
RO Ancoră suspensie MacPherson cu mâner interschimbabile
F Compresseurs de ressort MacPherson
I Smonta ammortizzatori per sospensioni MacPherson
E Extractor de resortes MacPherson con mangos intercambiables
CN 免拆式减震弹簧压缩器

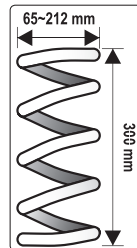

7
PCS

65-125
mm

88-160
mm

max. 1500kg

126-212
mm

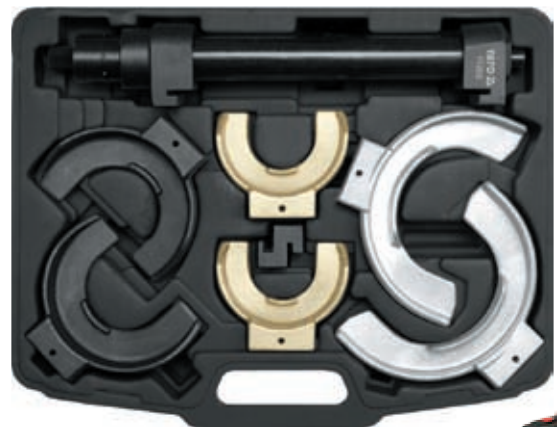

BMC & COLOR SLEEVE

YATO	
YT-2536	1

- GB Drive nut set
- D Stossdämpfer Nutmutter Einsätze
- PL Zestaw nasadek do amortyzatorów
- RUS Набор головок для амортизаторов
- CZ Sada hlavic na uložení tlumiče
- H Lengéscsillapítókiszedő szet
- RO Set prezoane
- F Set des embouts aux amortisseurs
- I Set di chiavi per aria condizionata
- E Juego de boquillas de amortiguadores
- CN 拆装减震器套件组套

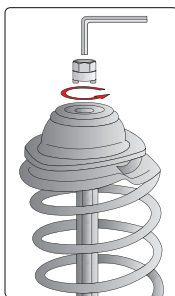

5
PCS



SLIDING
CARD

YATO	size / rozmiar (mm)	
YT-0621	10.5; 12.5; 14.5; 14.5; 14.0	12/48

- No. 1 10.5 mm VW Golf rear
- No. 2 12.5 mm VW Golf front
- No. 3 14.5 mm VW Polo, Golf, Passat, Audi 80
- No. 4 14.5 mm Austin Maestro
- No. 5 14.0 mm Mercedes Benz C-Class (W203)

- GB Turnbuckle for shock absorber's top lid
- D Schlüsselsatz zum Befestigen der Stoßdämpfer
- PL Zestaw kluczy do mocowania amortyzatorów
- RUS Набор ключей для крепления амортизаторов
- CZ Sada klíčů k montáži tlumičů
- H Kulcskészlet lengéscsillapítók rögzítéséhez
- RO Set chei pt. fixare amortizoare
- F Set de clés pour amortisseurs
- I Set chiavi per montare ammortizzatori
- E Juego de llaves para la instalación de amortiguadores
- CN 避震器拆卸器

39 PCS CrMo SCM415 CrV 6140 CrV 50BV30 STEEL 8660

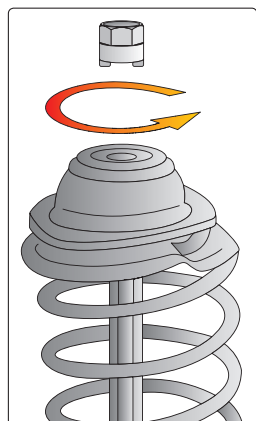

BMC
& COLOR
SLEEVE

YATO	size / rozmiar (mm)	type of car / model samochodu	size / rozmiar (mm)	type of car / model samochodu
CrMo SCM415	10.5 x 3.5	VW Golf Rear Axle	D5	Nissan
	12.5 x 3.5	VW Golf Front Axle	D10	Nissan, Ford
	14.5 x 5	VW Polo, Golf, Passat, Audi 80	8	Mercedes-Benz
	14.5 x 3	Austin Maestro	9	Opel/Vauxhall, Chrysler
	14 x 2.5	Mercedenz Benz W203 (C-class), W209 (CLK)	10	Chrysler, Ford
	14	Honda, Nissan	11	Japanese Cars
	16	VW, Audi, Seat, Fiat	5	Honda
	17	Ford, VW, Audi, Seat, Fiat	6	Seat, Fiat, Citroen, Peugeot, Ford, Opel, Renault, Japanese Cars, BMW
	18	Ford, VW, Audi, Seat, Rover, Fiat, Opel, Peugeot, Renault, Japanese Cars	7	VW, Audi, Seat, Fiat, Citroen, Peugeot, Mercedes-Benz (W203), Renault
	19	VW, Audi, Seat, Citroen, Fiat, Opel, Peugeot, Toyota	8	Mercedes-Benz
	21	Mercedenz-Benz W203, Chrysler, VW, Audi, Ford, Japanese Cars	3	Mercedes-Benz, Opel, Renault
	22	VW, Audi, Seat, Citroen, Fiat, Opel, Peugeot, Renault, BMW	3.5	Chrysler, Ford, Citroen, Peugeot
24	Volvo	4	Citroen, Peugeot	
27	VW, Audi, Citroen, Peugeot	M12	Opel/Vauxhall	
CrV 6140	4	Nissan	T50	Nissan, Ford
	5.2	VW, Audi, Nissan	T60	Ford
	6	VW, Audi, Renault		
	6.3	Nissan		
	7	VW, Audi, Seat, Fiat		
	8	Seat, Fiat		
	9	Japanese Cars		
	10	Seat, Fiat, Volvo		
CrV 50BV30	5	Ford, VW, Audi, Seat, Rover, Fiat, Opel, Peugeot, Renault, Japanese Cars		
	6	Seat, Fiat, Citroen, Peugeot, Ford, Opel, Renault, Japanese Cars, BMW		
	7	VW, Audi, Seat, Citroen, Fiat, Opel, Peugeot, Renault, BMW		
	8	Volvo		
	9	VW, Audi, Citroen, Peugeot		
	10	Nissan		
	11	VW, Audi, Nissan		
	12	VW, Audi, Renault		
	13	Nissan		
	14	VW, Audi, Seat, Fiat		
	15	Seat, Fiat		
	16	Japanese Cars		
17	Seat, Fiat, Volvo			

- GB Tire valve stem inserter
- D Abziehvorrichtung für die Gummiventile
- PL Przeciągacz do zaworków gumowych
- RUS Протяжка к резиновым клапанам
- CZ Páka k provlékání bezdušových ventilů
- H Gumiszelep-metsző
- RO Broșă pt. supapele cauciucate
- F Levier tire-valve
- I Brocca valvola di gomma
- E Brocha de tracción para las válvulas de goma
- CN 气门插入工具

SLIDING
CARD

290
mm

RUBBER
VALVES
ZAWORKY
GUMOWE



YATO	L (mm)	
YT-0619	290	12/72

- GB Wheel balance pliers
D Auswuchtgewicht-Zange
PL Szczypce do wyważania kół
RUS Клещи для балансировки колес
CZ Kleště pro vyvažování kol
H Centirsúly szerelő szerszám
RO Cleste pt. cauciuc
- F Pincers pour le contrepois à agrafe de roue de voiture
I Pinze per equilibrio ruota
E Tenazas de equilibrar ruedas
CN 平衡钳

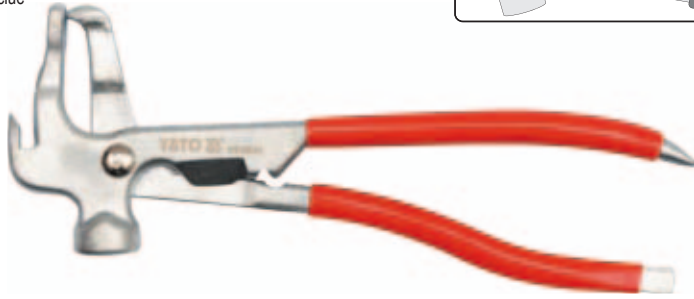
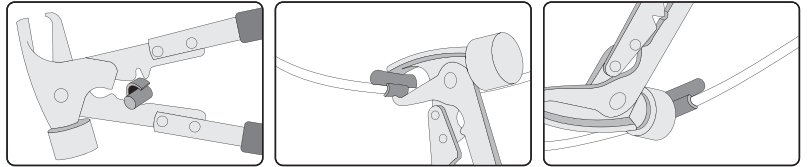

SLIDING CARD

YATO		
YT-0643		12/48

- GB Deep thin wall impact sockets
D Schon-Kraftschraubereinsatz für Alufelgen
PL Zestaw nasadek udarowych do felg aluminiowych
RUS Набор головок для алюминиевых дисков
CZ Sada nástrčných klíčů na alu ráfky
H Hosszított dugókulcs készlet, könnyűfém felnikhez
RO Dibli de impact cu mufare in interior
F Set de douilles profondes à choc
I Set di chiavi a bussola per dadi ruota di alluminio
E Juego de boquillas de percusión para llantas de aluminio
CN 风动薄壁长套筒



3 PCS	1/2" 12.5mm	17 19 21 mm
CrMo SCM-440	26 29 31 mm	AS-DRIVE

- for service station and tire workshops
- for maximum impact loads
- drive locks
- ultra thin walls and nylon cover for working with alu rims
- anodised colour finish for fast identification of size
- dla serwisów i warsztatów oponiarskich
- do największych obciążeń udarowych i tętniących
- zamki blokujące
- ultra cienkie ścianki i nylonowe pokrycie do pracy z felgami aluminiowymi
- anodowane kolorowe wykończenie dla szybkiej identyfikacji rozmiaru



BMC & COLOR BOX

YATO	Ø	
YT-1056	1/2" (12.7 mm)	12/24

- GB Rubber valve core torque tool
D Drehmomentwerkzeug für gummi Dichtende Reifenventileinsätze
PL Klucz dynamometryczny do zaworków gumowych
RUS Ключ динамометрический для резиновых клапанов
CZ Klíč momentový k montáži gumových ventilů
H Szeleptűkiszerező kulcs gumitömítésű szelephez
RO Surubelnita din plastic pt. supapa
F Clé dynamométrique pour soupapes
I Giravite dinamometrica per valvole
E Llave dinamométrica de válvulas de goma
CN 定扭橡胶气门芯拆卸工具

SLIDING CARD

0.25
Nm

RUBBER VALVES ZAWORY GUMOWE

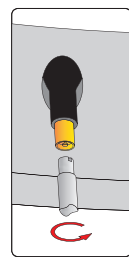

YATO		
YT-0795		50/200

- GB Metal valve core torque tool
D Drehmomentwerkzeug für metallisch Dichtende Reifenventileinsätze
PL Klucz dynamometryczny do zaworków metalowych
RUS Ключ динамометрический для металлических клапанов
CZ Klíč momentový k montáži kovových ventilů
H Szeleptűkiszerező kulcs fémtömítésű szelephez
RO Surubelnita metalica pt. supapa
F Clé dynamométrique pour soupapes
I Giravite dinamometrica per valvole
E Llave dinamométrica de válvulas de metal
CN 定扭橡胶气门芯拆卸工具

SLIDING CARD

0.45
Nm

METAL VALVES ZAWORY METALOWE

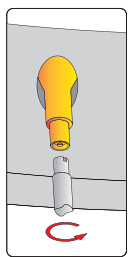

YATO		
YT-0796		50/200

- GB Cross rim wrench
D Kreuzschlüssel
PL Krzyżakowy klucz do kół
RUS Ключ-крест балонный
CZ Klíč na kola křížový
H Kereszt kerékkulcs
RO Cheie în cruce pt. roți
F Clé en croix aux roues
I Chiavi a croce per auto ruota
E Llave cruz para ruedas
CN 十字套筒扳手



CrV



PLASTIC HANGER

YATO	size / rozmiar	
YT-0800	17 x 19 x 21 x 22 mm	10
YT-0801	17 x 19 x 21 x 1/2" (12.7 mm)	10
YT-0802	24 x 27 x 32 x 3/4" (19.0 mm)	3

- GB T-type sleeved ratchet wrench
- D Radmutter Schlüssel für Autos
- PL Klucz do kół samochodowych
- RUS Ключ к автомобильным колесам
- CZ Klíč na kola automobilů
- H Kerékkulcs
- RO Cheie pt. roți de automobile
- F Clé cliquet aux roues
- I Chiavi per ruota auto
- E Llaves para las ruedas de automóviles
- CN T型棘轮扳手组套



- 4 PCS
- 1/2" 12.5mm
- 44T
- CrV 50BV30
- AS-DRIVE



PLASTIC HANGER



YATO	
YT-0803	5/10

1/2" (12.7 mm): 17, 19, 21, 23 mm

- GB Folding cross wrench
- D Radmutter Schlüssel
- PL Składany klucz do kół w etui
- RUS Балонный крестовой разборный ключ с чехлом
- CZ Skládací křížový klíč na matice
- H Összecsukható kereszt csavarkulcs
- RO Cheie cruce pt. șuruburi roți
- F Clé démonte roue en croix démontable
- I Pierevole cress chiave
- E llaves para las ruedas de automóviles
- CN 快速十字扳手

- 4 PCS
- 17 mm
- 19 mm
- 21 mm
- 23 mm
- 1/2" 12.5mm
- CrV
- WALLET ETUI

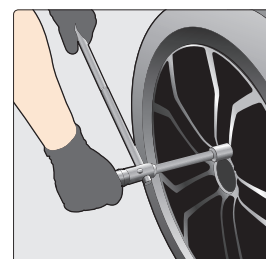

YATO	size / rozmiar	
YT-08035	1/2" (12.7 mm)	10

- GB Wrecking bar
- D Reifenmontierhebel
- PL Łyzka do opon
- RUS Прибор для шиномонтажа
- CZ Montážní páka na pneumatiky
- H Gumiabroncs kar
- RO Levier pt. roți
- F Cuillère à pneus
- I Leva per pneumatici
- E Desmontable para las llantas
- CN 轮胎起子



- 300 mm
- 400 mm
- 500 mm
- 600 mm
- CrV

YATO	size / rozmiar (mm)	
YT-0807	300	20
YT-0808	400	20
YT-0809	500	5/20
YT-0810	600	5/20

- GB Tire level
- D Reifenmontierhebel
- PL Łyzka do opon
- RUS Прибор для шиномонтажа
- CZ Montážní páka na pneumatiky
- H Gumiabroncs kar
- RO Levier pt. roți
- F Cuillère à pneus
- I Leva per pneumatici
- E Desmontable para las llantas
- CN 撬棒



SLIDING CARD



- 380 mm
- CrMo

YATO	size / rozmiar (mm)	
YT-0811	380	10/50

- GB Rectangular telescopic inspection mirror
D Teleskop Inspektionsspiegel
PL Lusterko inspekcyjne
- RUS Зеркало инспекционное телескопическое
CZ Zrcátko kontrolní teleskopické
H Vizsgáló tükör, teleszkópos nyéllal
- RO Oglinda telescopica pt. inspectie
F Miroir d'inspection
I Telescopio ispezione specchietto
- E Espejo rectangular telescópico de inspección
CN 可伸缩矩形检测镜

50x90 mm
TELESCOPIC HANDLE
285x770 mm



YATO
YT-0660 12/144

- GB LED lighted telescopic inspection mirror
D Prüfspiegel mit Beleuchtung
PL Lusterko inspekcyjne z lampką
- RUS Зеркало досмотровое с подсветкой
CZ Inspekční zrcadélko s lampou
H Vizsgáló tükör, lámpával
- RO Oglindă pt. inspectie cu lampă
F Miroir d'inspection avec lampe
I Specchio di ispezione con lampada
- E Espejo de control con lámpara
CN 带灯检测镜

265 - 920 mm; ∅54 mm
TELESCOPIC HANDLE
TELESKOPOWY UCHWYT

LED

STAINLESS STEEL
STAL
NIERDZEWNA



YATO
YT-0663 10/100

- GB Inspection camera
D Inspektionskamera
PL Kamera inspekcyjna
RUS Контрольная камера
CZ Inspekční kamera
H Felügyelő kamera
RO Cameră de inspectie
F Camera d'inspection
I Camera di ispezione
E Cámara de inspección
CN 手持式电子可视检查仪



BMC & COLOR SLEEVE

900 mm
60°
12.2 mm
LED CAMERA LIGHTING
OSWIETLACIE KAMERY LED

9V (6LR61) BATTERY

LCD COLOR SCREEN
320 x 240 QVGA
KOLOROWY EKRAŃ LCD

YATO
YT-7291 LCD TFT 2.4" (61 mm) 4



9V (6LR61) BATTERY

LCD COLOR SCREEN
320 x 240 QVGA
KOLOROWY EKRAŃ LCD

YATO
YT-7290 LCD TFT 3.5" (89 mm) 4



WI-FI
3.7V LiPo Polymer BATTERY
AKUMULATOR LiPo Polymer

LCD COLOR SCREEN
320 x 240 QVGA
KOLOROWY EKRAŃ LCD

YATO
YT-7292 LCD TFT 3.5" (89 mm) 4

GB Telescopic magnetic pick up tool
D Teleskop magnet Heber
PL Chwytyk teleskopowy z magnesem
RUS Захват магнитный телескопический

CZ Patka teleskopická magnetická
H Felszedő mágnes, teleszkópos nyéllel
RO Telescop magnetic
F Capteur magnétique

I Telescopio magnete
E Herramienta levantadora magnética, telescópica
CN 可伸缩磁性拾拾器

2 kg



TELESCOPIC HANDLE
250x750 mm



YATO
YT-0661 12/144

GB Telescopic magnetic pick up tool
D Teleskop magnet Heber
PL Chwytyk teleskopowy z magnesem
RUS Захват магнитный телескопический

CZ Patka teleskopická magnetická
H Felszedő mágnes, teleszkópos nyéllel
RO Telescop magnetic
F Capteur magnétique avec une diode

I Telescopio magnete
E Herramienta levantadora magnética, telescópica
CN 可伸缩磁性拾拾器



190 - 800mm
TELESCOPIC HANDLE
UCHWYT TELESKOPOWY



YATO
YT-0661 12/144

GB Telescopic magnetic pick up tool
D Teleskop magnet Heber
PL Chwytyk teleskopowy z magnesem
RUS Захват магнитный телескопический
CZ Patka teleskopická magnetická
H Felszedő mágnes, teleszkópos nyéllel
RO Telescop magnetic
F Capteur magnétique telescopique
I Telescopio a specchio
E Herramienta levantadora magnética, telescópica
CN 可伸缩磁性拾拾器

22.5 kg

82 mm

TELESCOPIC HANDLE
UCHWYT TELESKOPOWY
59~99 cm



YATO
YT-0860 L (mm) 59-99 6/24

GB Telescopic pick up and mirror set
D Inspektionsatz: Spiegel + Greifer
PL Zestaw inspekcyjny: lusterko + chwytak
RUS Проверочный набор + держатель и зеркальце
CZ Inspekční souprava: zrcadlo + držák
H Teleszkópos ellenőrző készlet: tükör + felvevő
RO Garnitură de control: oglindă + benă
F Kit miroir + grappin
I Set per ispezione: specchio + supporto
E Juego de inspección: espejo + cuchara de mordazas
CN 检测镜拾拾器组套

PLASTIC BOX & DOUBLE BLISTER



4 PCS

0,5 kg (max)
1,5 kg (max)

160 - 520 mm
TELESCOPIC HANDLE
UCHWYT TELESKOPOWY

250 - 930 mm, Ø 57 mm
TELESCOPIC HANDLE
UCHWYT TELESKOPOWY



YATO
YT-0662 10/40

GB Magnetic parts tray
D Magnetschale
PL Miska magnetyczna
RUS Магнитный поднос
CZ Miska magnetická
H Mágneses tálca

RO Tava magnetica
F Bol magnétique
I Ciotola magnetica

E Bandeja de accesorios magnética
CN 磁盘

COLOR BOX



Ø mm
110

YATO
YT-08295 12/48



Ø mm
150

YATO
YT-0830 12/48

GB Magnetic parts tray
D Magnetschale
PL Miska magnetyczna
RUS Магнитный поднос
CZ Miska magnetická
H Mágneses tálca
RO Tava magnetica
F Bol magnétique
I Ciotola magnetica
E Bandeja de accesorios magnética
CN 磁盘

0,10-0,12 T (TESLA)

Ø mm
150



COLOR BOX

YATO
YT-08305 20

GB Magnetic parts tray
D Magnetschale
PL Miska magnetyczna
RUS Магнитный поднос
CZ Miska magnetická
H Mágneses tálca
RO Tava magnetica
F Bol magnétique
I Ciotola magnetica
E Bandeja de accesorios magnética
CN 磁盘

COLOR BOX



350x150 mm



YATO
YT-0831 6/12

GB Magnetic tool holder
D Magnet Werkzeughalter
PL Listwa magnetyczna
RUS Магнитная рейка
CZ Magnetický držák nářadí

H Mágneses tartó
RO Suport magnetic
F Barre et porte
I Striscia magnetica

E Bandeja de accesorios magnética
CN 磁性工具架

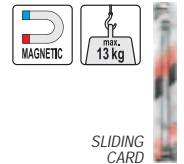

YATO	
YT-0835	4/16

GB Magnetic holder for tools
D Magnethalter für Schlagschrauber
PL Uchwyt magnetyczny na narzędzia
RUS Магнитный держатель для ударного гайковерта
CZ Magnetický držák nářadí
H Mágneses befogó
RO Suport magnetic pt. scule pneumatice

F Support magnétique pour outils pneumatiques
I Fissaggio magnetico per chiave ad impulsione pneumatica
E Soporte magnético para llave de impacto
CN 磁性喷枪架



15 kg max.

COLOR BOX



YATO	
YT-08707	5/10

GB Tweezer
D Pinzette
PL Peşeta
RUS Пинцет

CZ Pinzeta
H Csipesz
RO Pensetă
F Pince

I Pinza
E Pinzas
CN 镊子

SLIDING CARD



302 STAINLESS STEEL / STAL NIERDZEWNA
ANTI MAGNETIC / ANTYMAGNETYCZNA
ANTIACID / KWASO-ODPORNA



140 mm HRC 30

YATO	L (mm)	
YT-6903	140	20/480



115 mm HRC 30

YATO	L (mm)	
YT-6907	115	20/480



140 mm HRC 40

YATO	L (mm)	
YT-6916	140	20/480

GB Workshop creeper
D Werkstatt-Liege
PL Leżanka warsztatowa
RUS Лежак ремонтный
CZ Lehátko
H Fekpad gurulos
RO Targa
F Chariot de visite
I Lettino sdraio sotto vettura
E Camilla de taller
CN 汽修躺板



100 cm

WHITE CARTON BOX & COLOR LABEL



YATO	
YT-0880	1

GB Workshop LED battery lamp
 D LED Akku-handleuchte
 PL Diodowa lampa warsztatowa akumulatorowa
 RUS Светодиодная беспроводная лампа
 CZ Ruční svítidla LED
 H Ledes szerelőlámpa címkéjű cikkeg
 RO Lampa portabila cu acumulator leduri
 F Lampe a LED rechargeable
 I Lampada LED per officina
 E Linterna LED recargable
 CN 可充式LED灯



3W	3.7V 2200mAh Li-Ion
250 lm	6000 K
230V~50Hz BATTERY CHARGER LADOWARKA	CHARGING TIME CZAS LADOWANIA 5 h
IP54	WORK TIME CZAS PRACY 3.5 h
IK07	HOOK HAK
POLYCARBONATE DIFFUSER KŁOSZ Z POLIWĘGLANU	MAGNETIC

COB LED

360°

HANGING COLOR BOX WITH WINDOW

YATO
YT-08563 10

GB Workshop LED battery lamp
 D LED Akku-handleuchte
 PL Diodowa lampa warsztatowa akumulatorowa
 RUS Светодиодная беспроводная лампа
 CZ Ruční svítidla LED
 H Ledes szerelőlámpa címkéjű cikkeg
 RO Lampa portabila cu acumulator leduri
 F Lampe a LED rechargeable
 I Lampada LED per officina
 E Linterna LED recargable
 CN 可充式LED灯

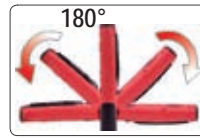

FRONT LIGHTING FUNKCJA LATARKI	3.5+3 W	3.7V 2200mAh Li-Ion
280 lm	6000 K	
USB BATTERY CHARGER LADOWARKA	CHARGING TIME CZAS LADOWANIA 5.5 h	
IP54	WORK TIME CZAS PRACY 3.5 h	
IK07	x2 HOOK HAK	
POLYCARBONATE DIFFUSER KŁOSZ Z POLIWĘGLANU	x3	

SMD LED



HANGING COLOR BOX

YATO
YT-08508 12

GB Workshop LED battery lamp
 D LED Akku-handleuchte
 PL Diodowa lampa warsztatowa akumulatorowa
 RUS Светодиодная беспроводная лампа
 CZ Ruční svítidla LED
 H Ledes szerelőlámpa címkéjű cikkeg
 RO Lampa portabila cu acumulator leduri
 F Lampe a LED rechargeable
 I Lampada LED per officina
 E Linterna LED recargable
 CN 可充式LED灯



CRI 95	5W	3.7V 2600mAh Li-Ion	400 lm	4500 K
CHARGING TIME CZAS LADOWANIA 4h	WORK TIME CZAS PRACY 4h			
IP65	IK07			
HOOK HAK	2x			

COB LED

360°

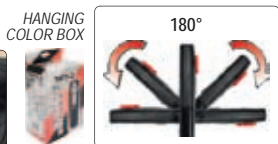

YATO
YT-08509 12

GB Workshop LED battery lamp
 D LED Akku-handleuchte
 PL Diodowa lampa warsztatowa akumulatorowa
 RUS Светодиодная беспроводная лампа
 CZ Ruční svítidla LED
 H Ledes szerelőlámpa címkéjű cikkeg
 RO Lampa portabila cu acumulator leduri
 F Lampe a LED rechargeable
 I Lampada LED per officina
 E Linterna LED recargable
 CN 可充式LED灯



COB LED

COLOR BOX

YATO
YT-08502 10

GB Workshop LED battery lamp
D LED Akku-handleuchte
PL Diodowa lampa warsztatowa akumulatorowa
RUS Светодиодная беспроводная лампа
CZ Ruční svítidla LED
H Ledes szerelőlámpa címkéjű cikkek
RO Lampa portabila cu acumulator leduri
F Lampe a LED rechargeable
I Lampada LED per officina
E Linterna LED recargable
CN 可充莫駄釘腑



3+1 LED
3.7V
3600mAh
Li-Ion
250 lm
230V~50Hz
BATTERY CHARGER
LADÓVÁRKA
12V
BATTERY CHARGER
LADÓVÁRKA
CHARGING TIME
CZAS ŁADOWANIA
4.5 h
WORK TIME
CZAS PRACY
5 h
3 LED
HOOK HAK
MAGNETIC
IP64



POWER LED



YATO
YT-08561 10

GB Workshop LED battery lamp
D LED Akku-handleuchte
PL Diodowa lampa warsztatowa akumulatorowa
RUS Светодиодная беспроводная лампа
CZ Ruční svítidla LED
H Ledes szerelőlámpa címkéjű cikkek
RO Lampa portabila cu acumulator leduri
F Lampe a LED rechargeable
I Lampada LED per officina
E Linterna LED recargable
CN 可充莫駄釘腑



30+7 LED
140 lm
3.7V
2000mAh
Li-Ion
USB BATTERY CHARGER
LADÓVÁRKA
WORK TIME
CZAS PRACY
4h
CHARGING TIME
CZAS ŁADOWANIA
4h
x3
x2 HOOK HAK
POLYCARBONATE DIFFUSER
KÖZÖS Z PÓLMECHANI

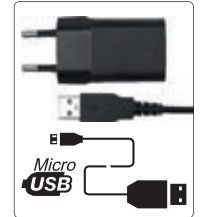
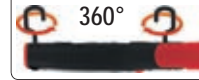
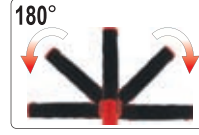

YATO
YT-08507 12

GB Workshop LED battery lamp
D LED Akku-handleuchte
PL Diodowa lampa warsztatowa akumulatorowa
RUS Светодиодная беспроводная лампа
CZ Ruční svítidla LED
H Ledes szerelőlámpa címkéjű cikkek
RO Lampa portabila cu acumulator leduri
F Lampe a LED rechargeable
I Lampada LED per officina
E Linterna LED recargable
CN 可充莫駄釘腑

27 LED
13000 MCD
3.6V
1200mAh
Ni-MH
12V
BATTERY CHARGER
LADÓVÁRKA
230V~50Hz
BATTERY CHARGER
LADÓVÁRKA
WATER PROOF
ODPORNA NA WODĘ
WORK TIME
CZAS PRACY
4h
CHARGING TIME
CZAS ŁADOWANIA
4h
HOOK HAK
MAGNETIC



LED

DOUBLE BLISTER



YATO
YT-08523 10

GB Workshop LED battery lamp
D LED Akku-handleuchte
PL Diodowa lampa warsztatowa akumulatorowa
RUS Светодиодная беспроводная лампа
CZ Ruční svítidla LED
H Ledes szerelőlámpa címkéjű cikkek
RO Lampa portabila cu acumulator leduri
F Lampe a LED rechargeable
I Lampada LED per officina
E Linterna LED recargable
CN 可充莫駄釘腑

30+7 LED
13000 MCD
3.6V
1200mAh
Ni-MH
12V
BATTERY CHARGER
LADÓVÁRKA
230V~50Hz
BATTERY CHARGER
LADÓVÁRKA
FRONT LIGHTING
FUNKCIJA LATARNI
CHARGING TIME
CZAS ŁADOWANIA
4-5 h
WORK TIME
CZAS PRACY
15h
7LED
4h
30LED
HOOK HAK
MAGNETIC



LED

COLOR BOX



YATO
YT-08505 10

GB Rechargeable work lamp
 D Led Werkstattlampe
 PL Diodowa lampa warsztatowa
 RUS Светодиодная лампа LED
 CZ Montážní lampa diodová bezpřívodová
 H Ledlámpa
 RO Lampa cu LED
 F Lampe a LED rechargeable
 I Lampada LED per officina
 E Lámpara inalámbrica de diodos
 CN 可充电工作灯



60+1 LED	13000 MCD	7.2V 800mAh Ni-MH	230V~ 50Hz BATTERY CHARGER LADOWARKA
WORK TIME CZAS PRACY 4h	CHARGING TIME CZAS LADOWANIA 4h	WATER PROOF ODPORNA NA WODE	HOOK HAK
12V BATTERY CHARGER LADOWARKA	MAGNETIC	LED	

DOUBLE
BLISTER



YATO
YT-0852 5/20

GB LED workshop lamp
 D LED Werkstattlampe
 PL Diodowa lampa warsztatowa
 RUS Светодиодный светильник для мастерской
 CZ Montážní lampa
 H LED lámpa
 RO Lampa cu LED
 F Lampe d'atelier a LED
 I Lampada LED per autofficina
 E Lámpara de taller LED
 CN 可充式射灯



8 LED	80 lm	1.5V 3x AAA	WORK TIME CZAS PRACY 20 h 8 LED
SMD LED			

SLIDING
CARD



YATO
YT-08514 12/72

GB LED workshop lamp
 D LED Werkstattlampe
 PL Diodowa lampa warsztatowa
 RUS Светодиодная беспроводная лампа
 CZ Montážní lampa
 H LED lámpa
 RO Lampa cu LED
 F Lampe d'atelier a LED
 I Lampada LED per autofficina
 E Lámpara de taller LED
 CN 可充式射灯



8+1 LED	280 lm	3 LIGHTING OPTIONS OPCJE SWIECENIA	FRONT LIGHTING FUNKCJA LATARKI
WORK TIME CZAS PRACY 4 h 9 LED	1.5V 3x AA	HOOK HAK	MAGNETIC
SMD LED			



COLOR
BOX



YATO
YT-08513 50

GB LED workshop lamp
 D LED Werkstattlampe
 PL Diodowa lampa warsztatowa
 RUS Светодиодная лампа LED
 CZ Montážní lampa
 H LED lámpa
 RO Lampa cu LED
 F Lampe d'atelier a LED
 I Lampada LED per autofficina
 E Lámpara de taller LED
 CN 可充式射灯



4 LED	400 lm	IP65	CABLE H05RN-F KABEL
230V~ 50Hz	HOOK HAK	4.9m	POWER LED

COLOR
BOX



YATO
YT-08531 10

GB Workshop LED battery lamp
D LED Akku-handleuchte
PL Diodowa lampa warsztatowa akumulatorowa
RUS Светодиодная лампа LED
CZ Ruční svítilna LED
H Ledes szerelőlámpa cirkékjú cikkek

RO Lampa portabila cu acumulator leduri
F Lampe a LED rechargeable
I Lampada LED trasportabile per illuminazione di vani motore
E Linterna LED recargable
CN 引擎盖检修灯

SMD

LED

100 LED	600 lm	7.4V 2000mAh Li-Ion
230V~50Hz BATTERY CHARGER LASOWARKA	CHARGING TIME CZAS ŁADOWANIA 3-4 h	WORK TIME CZAS PRACY 4 h 100 LED
HOOK HAK	MAGNETIC	

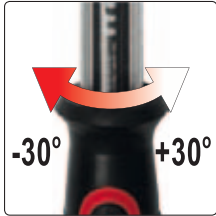

YATO
YT-08503 8

GB Workshop LED battery lamp
D LED Akku-handleuchte
PL Diodowa lampa warsztatowa akumulatorowa
RUS Светодиодная лампа LED
CZ Ruční svítilna LED
H Ledes szerelőlámpa cirkékjú cikkek

RO Lampa portabila cu acumulator leduri
F Lampe a LED rechargeable
I Lampada LED trasportabile per illuminazione di vani motore
E Linterna LED recargable
CN 引擎盖检修灯

LED

120 LED	13000 MCD	60 LED	120 LED
7.2V 1800mAh NiMH	230V~50Hz BATTERY CHARGER LASOWARKA	WORK TIME CZAS PRACY 8 h 60 LED	WORK TIME CZAS PRACY 4h 120LED
CHARGING TIME CZAS ŁADOWANIA 4-5 h	HOOK HAK	MAGNETIC	

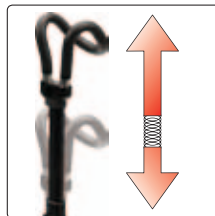
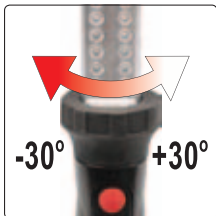

YATO
YT-08530 4

GB Workshop LED battery lamp
D LED Akku-handleuchte
PL Diodowa lampa warsztatowa akumulatorowa
RUS Светодиодная лампа LED
CZ Ruční svítilna LED
H Ledes szerelőlámpa cirkékjú cikkek

RO Lampa portabila cu acumulator leduri
F Lampe a LED rechargeable
I Lampada LED trasportabile per illuminazione di vani motore
E Linterna LED recargable
CN 引擎盖检修灯

SMD
LED

12W	1200 lm	4000 K	230V~50Hz
CABLE HOSRN-F KABEL	5 m	2x 1.0 mm ²	POLYCARBONATE DIFFUSER FILM Z POLYMERLAND
HOOK HAK	IP54		

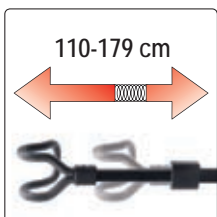

YATO
YT-08532 8

- GB LED aluminium torch
- D LED Taschenlampe aus Aluminium
- PL Latarka aluminiowa LED
- RUS LED алюминиевый фонарик
- CZ LED svítilna z hliníku
- H LED-es fém zseblámpa
- RO LED lanterna aluminiu
- F LED lampe de poche en aluminium
- I Torcia in alluminio
- E linterna de aluminio
- CN LED铝合金手电筒

9 LED 1.5V 3x AAA

LED



YATO			
YT-08570		24/192	

- GB High power diode torch with zoom function
- D Hochleistungs diode Taschenlampe mit Zoom-Funktion
- PL Latarka z diodą wysokiej mocy oraz funkcją zoom
- RUS Фонарик с LED высокой мощности и функцией зума
- CZ Svítilna s LED vysoký výkon a funkce zoom
- H Elemlámpa LED-es nagy teljesítményű és zoom funkciójával
- RO Lanterna cu LED-uri de mare putere si functie de zoom
- F Lampe de poche avec LED haute puissance et la fonction de zoom
- I Torcia di metallo
- E linterna con LED de alta potencia y función de zoom
- CN 手电筒LED高功率和变焦功能

3W 100 lm

IP64 1.5V 2x AA WATER PROOF ODPORNÁ NA WODĘ

POWER LED



YATO	W	lm	
YT-08571	3	100	24/96

- GB High power diode torch with zoom function
- D Hochleistungs diode Taschenlampe mit Zoom-Funktion
- PL Latarka z diodą wysokiej mocy oraz funkcją zoom
- RUS Фонарик с LED высокой мощности и функцией зума
- CZ Svítilna s LED vysoký výkon a funkce zoom
- H Elemlámpa LED-es nagy teljesítményű és zoom funkciójával
- RO Lanterna cu LED-uri de mare putere si functie de zoom
- F Lampe de poche avec LED haute puissance et la fonction de zoom
- I Torcia di metallo
- E linterna con LED de alta potencia y función de zoom
- CN 手电筒LED高功率和变焦功能

3W 110 lm

IP64 1.5V 2x AA WATER PROOF ODPORNÁ NA WODĘ

POWER LED



YATO	W	lm	
YT-08572	3	110	12/72

- GB High power diode torch with zoom function
- D Hochleistungs diode Taschenlampe mit Zoom-Funktion
- PL Latarka z diodą wysokiej mocy oraz funkcją zoom
- RUS Фонарик с LED высокой мощности и функцией зума
- CZ Svítilna s LED vysoký výkon a funkce zoom
- H Elemlámpa LED-es nagy teljesítményű és zoom funkciójával
- RO Lanterna cu LED-uri de mare putere si functie de zoom
- F Lampe de poche avec LED haute puissance et la fonction de zoom
- I Torcia di metallo
- E linterna con LED de alta potencia y función de zoom
- CN 手电筒LED高功率和变焦功能

3W 100 lm

IP64 1.5V 2x AA WATER PROOF ODPORNÁ NA WODĘ

POWER LED



YATO	W	lm	
YT-08575	3	100	12/72

16

- GB High power diode torch with zoom function
- D Hochleistungs diode Taschenlampe mit Zoom-Funktion
- PL Latarka z diodą wysokiej mocy oraz funkcją zoom
- RUS Фонарик с LED высокой мощности и функцией зума
- CZ Svítilna s LED vysoký výkon a funkce zoom
- H Elemlámpa LED-es nagy teljesítményű és zoom funkciójával
- RO Lanterna cu LED-uri de mare putere si functie de zoom
- F Lampe de poche avec LED haute puissance et la fonction de zoom
- I Torcia di metallo
- E linterna con LED de alta potencia y función de zoom
- CN 手电筒LED高功率和变焦功能

3W 130 lm

IP64 1.5V 2x C WATER PROOF ODPORNÁ NA WODĘ

POWER LED



YATO	W	lm	
YT-08577	3	130	12/48

- GB LED head lamp
- D LED kopflampe
- PL Diodowa lampka czołowa
- RUS Голобный светодиодный фонарь
- CZ LED montážní lampa - čelovka
- H LED fejlámpa
- RO Lampa cu LED
- F Lampe frontale LED
- I Lampada da testa
- E linterna de diodo
- CN LED头灯

3W 100 lm

IP64 1.5V 3x AAA WATER PROOF ODPORNÁ NA WODĘ

POWER LED

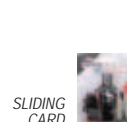

YATO	W	lm	
YT-08590	3	100	50/100

- GB Automotive circuit tester
D KFZ Prüflampe
PL Wskaźnik elektryczny samochodowy
RUS Пробник напряжения автомобильный
CZ Zkoušečka napětí autoelektrikářská
H Próbálampa

- RO Tester pt. circuite auto
F Testeur de tension de voiture
I Tester elettrico per auto
E Indicador eléctrico de coche
CN 汽车测电笔

SLIDING
CARD



CABLE
KABEL
90 cm



6-24 V

YATO		
YT-2865	10/250	



6-12 V

YATO		
YT-2866	10/100	

- GB Number stamp
D Nummernstempel
PL Znaczniki cyfrowe
RUS Клейма цифровые
CZ Razidla číselná
H Számbeütők
RO Poansoane cu cifre
F Chiffres à frapper
I Punzoni marcatori
E Marcadores de números
CN 数字冲模

9 PCS
NUMBERS
NUMERY
0 - 9
1045 CARBON
STEEL
HRC
50-55



PLASTIC BOX
& COLOR SLEEVE



YATO	No (mm)	PCS packing:	
YT-6854	6	9	20
YT-6855	8	9	18

- GB Letter stamp
D Buchstabenstempel
PL Znaczniki literowe
RUS Клейма буквенные
CZ Razidla písmenová
H Betűbetűtők
RO Poansoane cu litere
F Lettres à frapper
I Punzoni marcatori
E Marcadores de letras
CN 字母冲模

27 PCS
LETTERS
LITERY
A - Z &
1045 CARBON
STEEL
HRC
50-55



PLASTIC BOX
& COLOR SLEEVE



YATO	No (mm)	PCS packing:	
YT-6862	6	27	12
YT-6863	8	27	8

- GB Thread repair set
D Reparatursatz für Gewinde
PL Zestaw do naprawy gwintów
RUS Набор для ремонта резьбы
CZ Souprava na opravu závitů
H Menetjavító készlet
RO Set pt. reparare filete
F Set d'helicoils
I Kit di riparazione per filettature
E Juego para reparar roscas
CN 螺纹修复组套



METAL BOX
& COLOR BOX

HSS
4341
STAINLESS
STEEL
MERCELEWNA

88
PCS

YATO	size / rozmiar	
YT-1769	M6 x 1.0 x 10.8 mm	5/10
	M8 x 1.25 x 10.8 mm	
	M10 x 1.5 x 13.5 mm	



131
PCS

YATO	size / rozmiar	
YT-1763	M5 x 0.8 x 6.7 mm	5/10
	M6 x 1.0 x 10.8 mm	
	M8 x 1.25 x 10.8 mm	
	M10 x 1.5 x 13.5 mm	
	M12 x 1.75 x 16.3 mm	

- GB Wire threads
D Spiraleinlagen für Gewindereparatur
PL Wkłady spiralne do naprawy gwintów
RUS Метчики и сверла для ремонта резьбы
CZ Spirálové vložky na opravu závitů
H Menetjavító betétek

- RO Insertii spirală pt. reparare filete
F Helicoil
I Inserti a spirale per riparazione
E Elementos espirales para reparar roscas
CN 不锈钢螺纹套

POLYBAG
WITH
HEADER



for / dla: YT-1763, YT-1769

STAINLESS
STEEL
MERCELEWNA

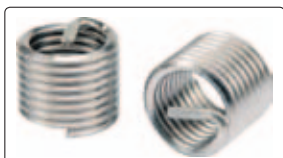

YATO	size / rozmiar	PCS packing:	
YT-1764	M5 x 0.8 x 6.7 mm	20	50/250
YT-1765	M6 x 1.0 x 10.8 mm	20	50/250
YT-1766	M8 x 1.25 x 10.8 mm	20	50/200
YT-1767	M10 x 1.5 x 13.5 mm	15	25/100
YT-1768	M12 x 1.75 x 16.3 mm	10	25/100

- GB Dual foot tire gauge
- D Reifendruckprüfer
- PL Ciężniomierz do aut ciężarowych
- RUS Манометр для грузовых автомобилей
- CZ Tlakomer na nákladní auta
- H Nyomásmérő tehergépkocsikhoz
- RO Indicator de presiune pt. camioane
- F Manometre pneu pour camions
- I Manometro per automezzi
- E Manómetro de caomones
- CN 胎压表



SLIDING CARD

YATO 	
YT-24301	25/100

- GB Foot pump with gauge
- D Fusspumpe
- PL Pompka nożna z manometrem
- RUS Насос ножный с манометром
- CZ Nožní pumpa z manometrem
- H Lábpumpa nyomásmérővel

- RO Pompă de picior cu manometru
- F Pompe à pied avec manomètre
- I Pompa a pedale con manometro
- E Bomba de pierna con manometro
- CN 打气筒



COLOR BOX

YATO 	
YT-7349	10

- GB Foot pump with gauge
- D Fusspumpe
- PL Pompka nożna z manometrem
- RUS Насос ножный с манометром
- CZ Nožní pumpa z manometrem
- H Lábpumpa nyomásmérővel
- RO Pompă de picior cu manometru

- F Pompe à pied avec manomètre
- I Pompa a pedale con manometro
- E Bomba de pierna con manometro
- CN 打气筒



TWIN PISTON
PODWÓJNY TŁOK



COLOR BOX

YATO 	
YT-7350	10

- GB Hand pump with manometer
- D Hand-Luftpumpe mit Manometer
- PL Pompka słupkowa z manometrem
- RUS Насос ручной с манометром
- CZ Pumpa z manometrem
- H Kézi pumpa manométerrel

- RO Pompa de mana cu manometru
- F Pompe manuelle avec manomètre
- I Pompa verticale con manometro
- E Bomba de barrote con manometro
- CN 带压力表打气筒



PLASTIC HANGER & TAG CARD





YATO 	
YT-7352	6

GB Funnel
D Trichter
PL Lejek
RUS Воронка гибкая
CZ Nálevka
H Kétrészes tölcseér
RO Pálnie
F Entonnoir
I Imbuto
E Embudo
CN 漏斗



Ø
135mm
PP

YATO 	Ø (mm)	
YT-0694	135	192

GB Long funnel
D Trichter
PL Lejek dlugi
RUS Воронка гибкая
CZ Nálevka
H Kétrészes tölcseér
RO Pálnie
F Entonnoir
I Imbuto
E Embudo
CN 漏斗





Ø
120mm
PP

YATO 	L (mm)	Ø (mm)	
YT-0693	455	120	48

GB Operating fluids funnel
D Trichter
PL Lejek do płynów eksploatacyjnych
RUS Воронка гибкая
CZ Nálevka
H Kétrészes tölcseér
RO Pálnie
F Entonnoir
I Imbuto
E Embudo
CN 漏斗





Ø
100mm
PP

YATO 	Ø (mm)	
YT-0695	100	180

GB Operating fluids funnel
D Trichter
PL Lejek do płynów eksploatacyjnych
RUS Воронка гибкая
CZ Nálevka
H Kétrészes tölcseér
RO Pálnie
F Entonnoir
I Imbuto
E Embudo
CN 漏斗





Ø
240mm
PP

YATO 	Ø (mm)	
YT-0696	240	48

GB Fuel and oil funnel
D Trichter
PL Lejek do paliwa i oleju eksploatacyjnych
RUS Воронка гибкая
CZ Nálevka
H Kétrészes tölcseér
RO Pálnie
F Entonnoir pour essence et huile
I Imbuto
E Embudo
CN 漏斗





Ø
150mm
PP

YATO 	Ø (mm)	
YT-0692	150	30

GB Oil funnel
D Trichter
PL Lejek do oleju
RUS Воронка гибкая
CZ Nálevka
H Kétrészes tölcseér
RO Pálnie
F Entonnoir
I Imbuto
E Embudo
CN 漏斗



Ø
280mm
PP

YATO 	Ø (mm)	
YT-0697	280	48

GB Oil drain pan
D Ölwanne
PL Miska do oleju
RUS Миска для масла
CZ Miska na olej
H Fárdotlaj felfogó edény
RO Recipient pt. ulei
F Bol à l'huile
I Vaschetta per cambio olio
E Escudilla para aceite
CN 接油盆





PP

YATO 	l	Ø (cm)	
YT-0699	8	37	48



PE

YATO 	l	Ø (cm)	
YT-0716	10	37	6
YT-0717	15	42	4



GB Oil drainer
D Öleinfüllanlage
PL Zlewarka do oleju
RUS Устройство для слива масла
CZ Olejová nádrž s odsáváním
H Fárdotlaj leszívó
RO Dispozitiv pt. schimbat ulei
F Récupérateur d'huile
I Scolapiatti dell'olio
E Decantador para aceite
CN 泄油器



75-155 cm
PE

WHITE CARTON BOX & COLOR LABEL



YATO 	l	Ø (cm)	
YT-0718	20	42	1

GB Hydraulic bottle jack
 D Hydraulischer Stempelwagenheber
 PL Podnośnik hydrauliczny słupkowy
 RUS Домкрат гидравлический
 CZ Pístový zvedák hydraulický
 H Hidraulikus emelő

RO Cric hidraulic
 F Elévateur
 I Cric idraulico a bottiglia
 E Gato de embolo hidr.
 CN 立式液压千斤顶

COLOR BOX

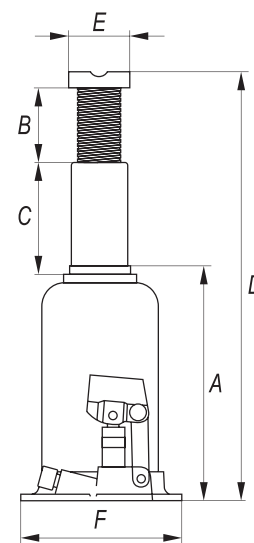
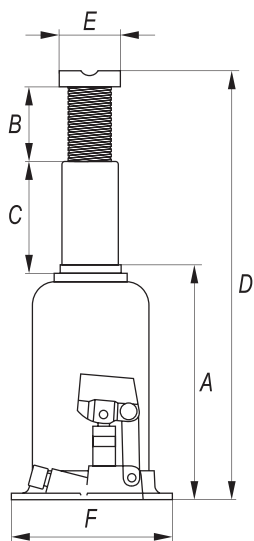

YATO	T	A (mm)	B (mm)	C (mm)	D (mm)	E (mm)	F (mm)	
YT-17000	2	181	48	164	345	25	88x92	6
YT-17001	3	194	60	180	374	27	92x100	6
YT-17002	5	216	60	180	413	29	96x110	4
YT-17003	8	230	80	147	457	32	103x118	2
YT-17004	10	230	80	150	460	36	110x123	2
YT-17005	12	230	80	155	465	40	116x134	2
YT-17006	15	230	82	150	462	43	140x134	2
YT-17007	20	242	60	150	452	45	144x150	2
YT-17008	32	285	-	180	465	69	190x152	1
YT-17009	50	300	-	180	480	83	218x176	1



YATO	T	A (mm)	B (mm)	C (mm)	D (mm)	E (mm)	F (mm)	
YT-1702	5	212	110	146	468	40	110x112	5
YT-1704	10	220	115	148	483	48	124x127.5	3
YT-1706	15	231	113	154	498	56	140x142	2
YT-1707	20	241	115	165	521	60	165x161	2
YT-1709	30	244	108	140	492	65	186x174	1

GB Two-piston hydraulic bottle jack
 D Hydraulischer Stempelwagenheber
 PL Podnośnik hydrauliczny słupkowy dwutłokowy
 RUS Домкрат гидравлический
 CZ Pístový zvedák hydraulický

H Hidraulikus emelő
 RO Cric hidraulic
 F Elévateur deux niveaux
 I Cric idraulico a bottiglia
 E Gato de embolo hidr.
 CN 液壓雙級千斤頂

COLOR BOX

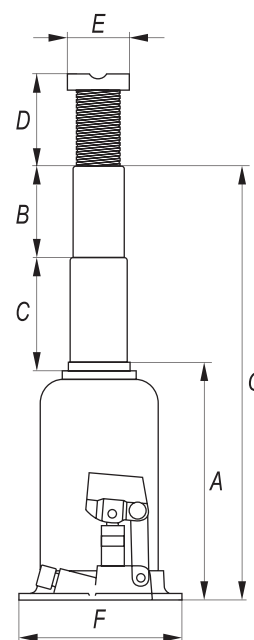
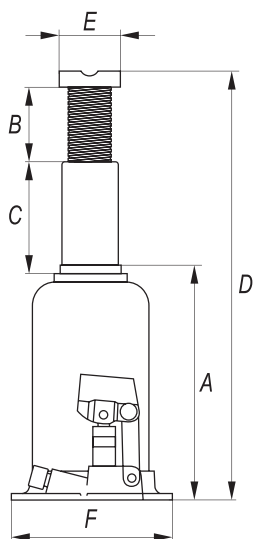

YATO	T	A (mm)	B (mm)	C (mm)	D (mm)	E (mm)	F (mm)	
YT-1711	5	222	146	138	500	41	130x136	2
YT-1713	10	128	63	38	223	47	160x165	2

YATO	T	A (mm)	B (mm)	C (mm)	D (mm)	E (mm)	F (mm)	G (mm)	
YT-1714	10	210	120	118	78	48	165x161	442	1
YT-1715	12	236	138	128	98	56	186x174.5	498	1

- GB Hydraulic floor jack
- D Hydraulischer Rangierwagenheber
- PL Podnośnik hydrauliczny
- RUS Домкрат гидравлический
- CZ Pístový zvedák hydraulický
- H Hidraulikus emelő
- RO Cric tip crocodil
- F Elévateur hydraulique
- I Sollevatore idraulico
- E Gato de embolo hidr.
- CN 卧式液压千斤顶



LOW PROFILE

2t

359 mm
89 mm

BMC & COLOR SLEEVE



YATO	T	
YT-1720	2	1



2.5t

457 mm
89 mm

COLOR BOX



YATO	T	
YT-1721	2.5	1



3t

465 mm
130 mm

COLOR BOX



YATO	T	
YT-17211	3	1

- GB Jack stand
- D Unterstellböcke
- PL Podstawka pod samochód
- RUS Подставка под автомобиль
- CZ Podstavec pod auto
- H Gépkocsi alátét
- RO Chituc de metal
- F Paire de chandelles
- I Coppia cavalletti
- E Apoyos de coche
- CN 千斤顶支架

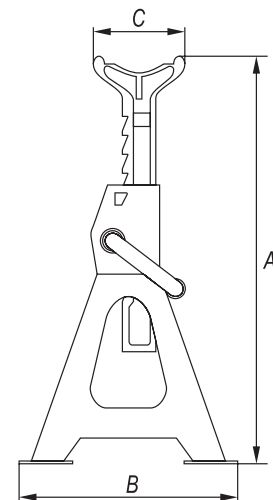

COLOR BOX



YATO	T	A (mm)	B (mm)	C (mm)	PCS packing	
YT-17310	2	265-415	190x165	77x40	2	1
YT-17311	3	280-420	182x201	85x29	2	1
YT-17312	6	382-600	258x285	100x29	2	1

- GB Electronic battery charger
- D Elektronisches Ladegerät
- PL Prostownik elektroniczny
- RUS Электронное зарядное устройство
- CZ Elektronická nabíječka
- H Elektronikus akkumulátortöltő
- RO Redresor electric
- F Chargeur de batterie voiture
- I Avviatore elettronico
- E Rectificador electrónico
- CN 蓄电池充电器



COLOR BOX



6 V	1 A
12 V	4 A
200 Ah max	230V~50Hz
WET GEL AGM	MOKRY ŽELOWY AGM



YATO 	
YT-8300	8





230V~50Hz	5-160 Ah
2 A	12 V
8 A	
WET GEL AGM	MOKRY ŽELOWY AGM



6 V	8 A
12 V	
5-200 Ah	230V~50Hz
WET GEL AGM	MOKRY ŽELOWY AGM



YATO 	
YT-83016	12

YATO 	
YT-8301	8

- GB Electronic battery charger
- H Elektronikus akkumulátortöltő
- D Elektronisches Ladegerät
- RO Redresor electric
- PL Prostownik elektroniczny
- F Chargeur de batterie voiture
- RUS Электронное зарядное устройство
- I Avviatore elettronico
- CZ Elektronická nabíječka
- E Rectificador electrónico
- CN 蓄电池充电器

COLOR BOX



12 V	12 A
6-200 Ah	230V~50Hz
	WET MOKRY

YATO 	
YT-8302	8



12 V	
15 A	6-200 Ah
230V~50Hz	WET GEL AGM
MOKRY ŽELOWY AGM	

YATO 	
YT-8303	8

GB Battery charger with boost function
D Ladegerät mit Boost-Funktion
PL Prostownik z funkcją wspomagania ładowania
RUS Выпрямитель с функцией поддержки зарядки
CZ Nabíječky s funkcií boost
H Akkumulátortöltő boost funkció

RO Redresor baterie cu functie boost
F Chargeur de batterie voiture support boost
I Carica batterie con boost
E Cargador de baterías arrancador boost
CN 充电器

COLOR BOX





230V~50Hz 12V 24V



16 A 120-240 Ah WET MOKRY

25 A 170-350 Ah WET MOKRY

YATO  YT-8304  2

YATO  YT-8305  2



15 A 10-300 Ah WET MOKRY AGM BOOST ROZRUCH 12V 75 A 

30 A  50-600 Ah WET MOKRY AGM BOOST ROZRUCH 12V 145 A

YATO  YT-83051  2

YATO  YT-83052  2

GB Battery charger with engine start-up supporting function
D Ladegerät mit Starthilfe
PL Prostownik z funkcją wspomagania rozruchu
RUS Выпрямитель с функцией поддержки запуска
CZ Nabíječky s funkcií startovani motoru
H Akkumulátortöltő indító

RO Redresor cu functie de pomire de sprijin
F Chargeur de batterie voiture support demarrage
I Carica batterie carrellato con funzione di avviatore rapido
E Cargador de baterías arrancador
CN 充电器启动机

GREY CARTON BOX & COLOR LABEL

230V~50Hz WET MOKRY



12V 27 A START ROZRUCH 300 A

24V 25 A START ROZRUCH 240 A

20-600 Ah

12V 32 A START ROZRUCH 390 A

24V 31 A START ROZRUCH 360 A

20-700 Ah

12V 38 A START ROZRUCH 540 A

24V 35 A START ROZRUCH 450 A

20-800 Ah

YATO  YT-83060  1

YATO  YT-83061  1

YATO  YT-83062  1

GB Jumpstart wires
D Starterkabel
PL Przewody rozruchowe
RUS Пусковые провода

CZ Startovací kabely
H Indító kábelek
RO Cabluri demarare
F Câbles de démarrage

I Cavi carica batteria
E Cables de arranque
CN 输出线

WINDOW BAG
WITH ZIPPER

2.5m



YATO	rated load / obciążenie nominalne (A)	
YT-83151	200	12

YATO	rated load / obciążenie nominalne (A)	
YT-83152	400	12

YATO	rated load / obciążenie nominalne (A)	
YT-83153	600	12

GB Analogue battery tester
D Analoges Batterieprüfgerät
PL Tester akumulatorów analogowy
RUS Аналоговый тестер аккумуляторов
CZ Analogový tester akumulátorů
H Analóg akkuteszter
RO Tester acumulatori analog
F Testeur de charge batterie
I Tester analogico per batteria
E Tester analógico para acumuladores
CN 电池测试器

6 V

12 V

CCA
200-
1000 A



COLOR
BOX



YATO	
YT-8310	10

GB Digital battery tester
D Digitales Batterieprüfgerät
PL Tester akumulatorów cyfrowy
RUS Цифровой тестер аккумуляторов
CZ Digitální tester akumulátorů
H Digitális akkuteszter
RO Tester acumulatori digital
F Testeur digital de charge batterie
I Tester digitale per batteria
E Tester digital para acumuladores
CN 电池测试器

12 V

LED
DISPLAY

CCA
150-
1400 A



COLOR
BOX



YATO	
YT-8311	10

GB Battery tester
D Batterieprüfgerät
PL Tester akumulatorów
RUS Тестер аккумуляторов
CZ Tester akumulátorů
H Akkuteszter
RO Tester acumulatori
F Testeur électronique de charge
batterie et alternateur
I Tester per batteria
E Tester para acumuladores
CN 电池测试器

12 V

BATTERY
TEST
TEST
AKUMULATORA

ALTERNATOR
TEST
TEST
ALTERNATORA



DOUBLE
BLISTER



YATO	
YT-83101	12/72

GB Refractometer
D Refraktometer
PL Refraktometr
RUS Рефрактометр
CZ Refraktometer
H Refraktometria

RO Refractometrul
F Réfractomètre
I Rifrattometro
E Refractometro
CN 冰点仪

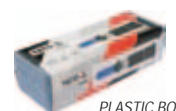

PLASTIC BOX
& COLOR SLEEVE

YATO	
YT-06722	20

- GB Chain block
D Kettenzug Flaschenzug
PL Wyciągarka łańcuchowa
RUS Таль цепная
CZ Zvedák řetězový
H Láncoz csigasor emelő
RO Scripete cu lant
F Treuil à chaîne
I Paranco a catena
E Cabria de cadena
CN 手拉葫芦



GREY
CARTON BOX
& COLOR LABEL

YATO	max. load capacity / max. ładowność (kg)	
YT-58950	500	1
YT-58951	1000	1
YT-58953	2000	1
YT-58954	3000	1
YT-58955	5000	1

PLYWOOD BOX
& COLOR LABEL

YATO	max. load capacity / max. ładowność (kg)	
YT-58957	10000	1

- GB Rope winch
D Handseilwinde
PL Wyciągarka linowa
RUS Канатная лебедка
- CZ Lanové vyťahovací zařízení
H Drótköteles csőrő
RO Troliu cu cablu orizontal
F Treuil à corde
- I Paranco a corda
E Cabria de cuerdas
CN 绳索拉紧器



1000
daN

YATO	daN	L (m)	Ø (mm)	
YT-5911	1000	3	5	6



1300
daN

YATO	daN	L (m)	Ø (mm)	
YT-5913	1300	3	5	6



1500
daN

YATO	daN	L (m)	Ø (mm)	
YT-5914	1500	3	6	3

- GB Electric hoist
D Elektro-Seilwinde
PL Elektryczny wciągnik linowy
RUS Электрическая канатная лебедка
CZ Elektrický naviják kladkostroj
H Elektromos csőrő
RO Troliu electric cu cablu
F Treuil électrique à corde
I Verricello elettrico
E Cabria eléctrica de cuerdas
CN 电动葫芦

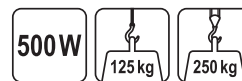

YATO		8 min max. 11m	4 min max. 5.5m	
YT-5901	2	125 kg	250 kg	

YATO		8 min max. 11m	4 min max. 5.5m	
YT-5904	2	250 kg	500 kg	

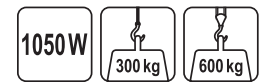
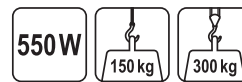

YATO		8 min max. 11m	4 min max. 5.5m	
YT-5902	2	150 kg	300 kg	

YATO		8 min max. 11m	4 min max. 5.5m	
YT-5905	2	300 kg	600 kg	



- GB Shop crane
- D Werkstattkran
- PL Żuraw warsztatowy
- RUS Кран подкатной гидравлический
- CZ Hydraulický jeřáb
- H Motorkiemelő zsráf
- RO Girafa pt. scos motor
- F Grue d'atelier
- I Gru idraulica
- E Grúa hidráulica para motores
- CN 吊机



GREY CARTON BOX
& COLOR LABEL



600
kg

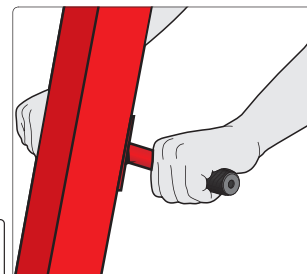

YATO 
YT-55560



1



1000
kg

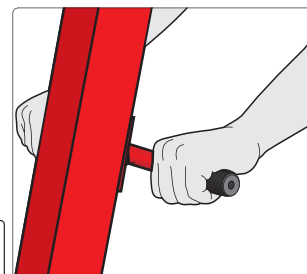

YATO 
YT-55561



1



2000
kg

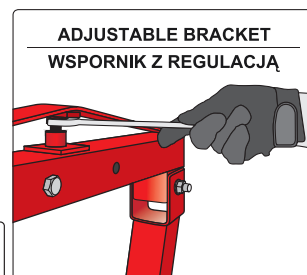

YATO 
YT-55562



1

GB Shop press
D Hydraulische Werkstattpresse
PL Prasa hydrauliczna
RUS Гидравлический пресс

CZ Hydraulický lis
H Hidraulikus prés
RO Prasa hidraulică
F Presse hydraulique

I Pressa idraulica
E Prensa de hidráulica
CN 压力机

GREY CARTON BOX
& COLOR LABEL



12t

0-695
mm

400
mm

20t

0-695
mm

490
mm



30t

0-795
mm

520
mm



YATO  
YT-55580 1

YATO  
YT-55581 1

YATO  
YT-55582 1

GB Crane crossbeam
D Traverse zum Kran
PL Traversa do żurawia
RUS Траверса для крана
CZ Jeřábová traverza
H Traverz a zsiráf emelőhöz

RO Traversă pt. macara
F Balancier pour grue d'atelier
I Traversa per gru
E Viga transversal para grua
CN 平衡器

680
kg

315
mm

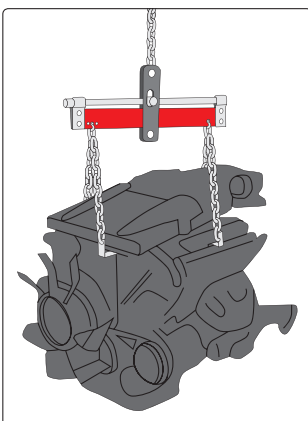

WHITE CARTON BOX
& COLOR LABEL



YATO  
YT-55565 1

GB Engine suspension beam
D Aufnahmevorrichtung des Motors
PL Belka do podwieszenia silnika
RUS Балка для вывешивания двигателя

CZ Nosník k zavěšení motoru
H Motorfelfüggesztő gerenda
RO Grindă pt. suspendarea motorului
F Poutre de suspension de moteur
I Fascio sospensione del motore

E La viga para suspender el motor
CN 发动机平衡架

500kg
max.

150
cm

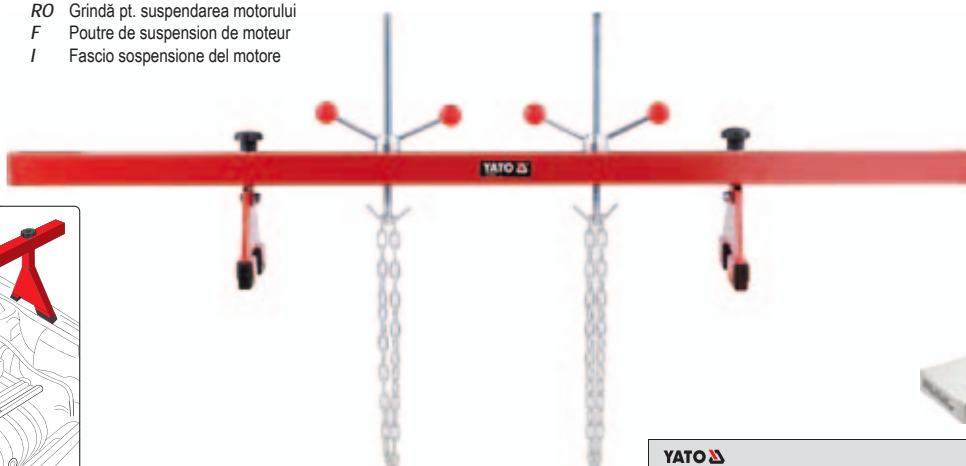
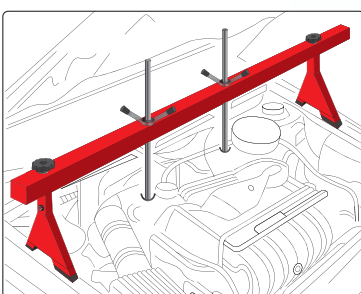

WHITE CARTON BOX
& COLOR LABEL



YATO  
YT-55568 1

GB Self locking nuts assortment
D Sortiment Muttern metrisch mit Sicherheit
PL Zestaw nakrętek metrycznych z zabezpieczeniem

RUS Набор гаек самоконтращиеся, с нейлоновой вставкой
CZ Šestihranné matice s bezpečností
H Nuts metrikus menet biztonsági
RO Set piulite autoblocante

F Hex écrou set avec la sécurité
I Set di autobloccanti metrica dadi
E Porcas rosca métrica com a segurança
CN 146件套螺母组套

PLASTIC HANGING BOX



146
PCS

INSERT LOCK
ZABEZPEČENIE

MIX
SIZE ROZMIAROW



M4, M5, M6, M8, M10, M12

YATO

YT-06774

5/20

GB Metric nuts assortment
D Sortiment Muttern metrisch
PL Zestaw nakrętek metrycznych
RUS Набор гаек

CZ Šestihranné matice
H Nuts metrikus menet
RO Set piulite
F Hex écrou set

I Set di metrica dadi
E Porcas rosca métrica
CN 300件套螺母组套

PLASTIC HANGING BOX



300
PCS

MIX
SIZE ROZMIAROW

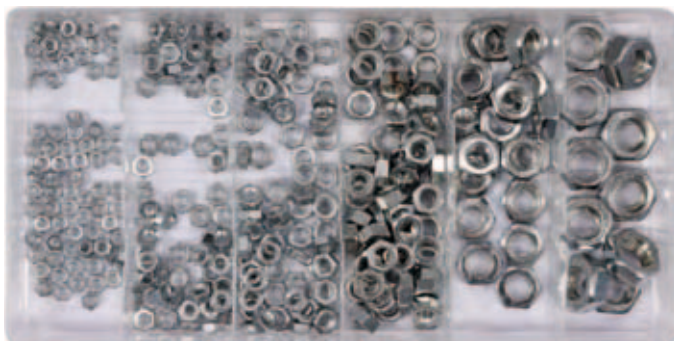

M3, M4, M5, M6, M8, M10

YATO

YT-06772

5/20

GB Stainless steel nuts assortment
D Sortiment Muttern metrisch rostfrei
PL Zestaw nakrętek metrycznych nierdzewnych
RUS Набор гаек шестигранных нержавеющей

CZ Nerezové oceli šestihranné matice
H Nuts metrikus menet rozsdamentes
RO Set piulite inox
F Hex écrou set inoxydable

I Set di acciaio inossidabile metrica dadi
E Rosca métrica tuerca inoxidable
CN 300件套不锈钢螺母组套

PLASTIC HANGING BOX



300
PCS

MIX
SIZE ROZMIAROW

STAINLESS STEEL
MERZDZEWNA

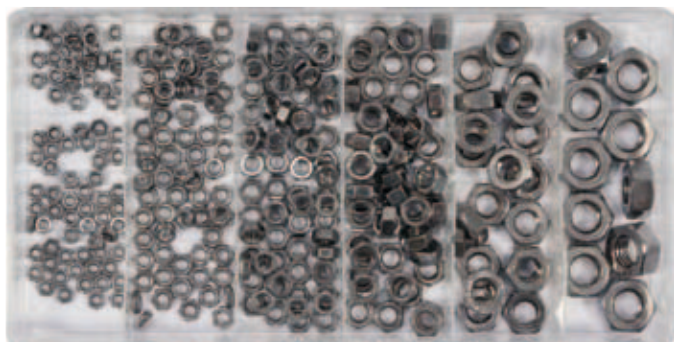

M3, M4, M5, M6, M8, M10

YATO

YT-06773

5/20

GB Hex nut with top assortment
D Sortiment Muttern metrisch geschlossen
PL Zestaw nakrętek metrycznych kolpakowych

RUS Набор гаек колпачковых
CZ Šestihranné matice zavřeno
H Nuts metrikus menet zárt
RO Set piulite inchise

F Hex écrou set fermé
I Set di dadi campana-metrica
E Rosca métrica tuercas cerrado
CN 150件套不锈钢螺母组套

PLASTIC HANGING BOX



150
PCS

MIX
SIZE ROZMIAROW

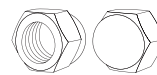
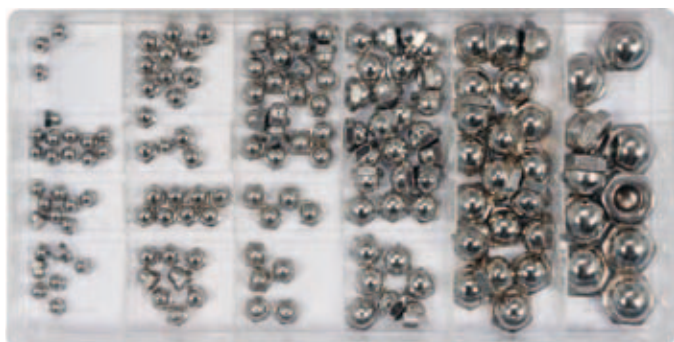

M3, M4, M5, M6, M8, M10

YATO

YT-06775

5/20

GB Metric wing nut assortment
D Sortiment Flügelmutter
PL Zestaw nakrętek motylkowych
RUS Набор гаек типа «барашек»

CZ Křídlaté matice lisované
H Szárnyas anya
RO Set piulițe fluture
F Assortiment d'écrous papillon

I Set di metrica dadi
E Tuerclas con orejas
CN 蝶形螺母

PLASTIC
HANGING BOX



150
PCS

MIX
SIZE
ROZMIAROW

METRIC
METRYCZNE

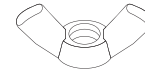

M4, M5, M6, M8, M10

YATO
YT-06776 25

GB Aluminium washer set
D Aluminium Dichtring Sortiment
PL Zestaw podkładek aluminiowych
RUS Набор алюминиевых шайб

CZ Sada hliníkových podložek
H Réz alátét készlet
RO Set saibe aluminii
F Assortiment de joints en aluminium

I Set di rondelle in alluminio
E Juego de arandelas de aluminio para tapones
CN 300件套铝垫片

PLASTIC BOX



300
PCS

MIX
SIZE
ROZMIAROW

METRIC
METRYCZNE

Al



10x 5x9x1.0 mm	10x 8x14x1.5 mm	10x 12x16x1.0 mm	10x 14x20x1.5 mm	10x 18x24x1.5 mm	10x 22x29x1.5 mm
10x 6x10x1.0 mm	10x 9x14x1.5 mm	10x 12x16x1.5 mm	10x 14x20x2.0 mm	10x 20x24.5x1.5 mm	10x 24x29x1.5 mm
10x 6x12x1.0 mm	10x 10x14x1.0 mm	10x 12x18x1.5 mm	10x 16x20x1.5 mm	10x 20x24.5x0.8 mm	10x 24x32x2.0 mm
10x 8x12x1.0 mm	10x 10x14x1.0 mm	10x 13x18x1.0 mm	10x 16x22x1.5 mm	10x 19x26x2.0 mm	10x 26x34x2.0 mm
10x 8x14x1.0 mm	10x 10x16x1.0 mm	10x 14x18x1.5 mm	10x 18x22x1.5 mm	10x 22x27x1.0 mm	10x 28x36x2.0 mm

5x9x1.0 mm, 8x14x1.5 mm, 12x16x1.0 mm, 14x20x1.5 mm, 18x24x1.5 mm, 22x29x1.5 mm, 6x10x1.0 mm, 9x14x1.0 mm, 12x16x1.5 mm, 14x20x2.0 mm, 20x24.5x1.5 mm, 24x29x1.5 mm, 6x12x1.0 mm, 10x14x1.0 mm, 12x18x1.5 mm, 16x20x1.5 mm, 20x24.5x0.8 mm, 24x32x2.0 mm, 8x12x1.0 mm, 10x14x1.5 mm, 13x18x1.0 mm, 16x22x1.5 mm, 19x26x2.0 mm, 26x34x2.0 mm, 8x14x1.0 mm, 10x16x1.0 mm, 14x18x1.5 mm, 18x22x1.5 mm, 22x27x1.0 mm, 28x36x2.0 mm

YATO
YT-06865 5/20

GB Copper washer set
D Kupfer Dichtring Sortiment
PL Zestaw podkładek miedzianych
RUS Набор колец медных

CZ Podložky měděné těsnící
H Réz tömítés készlet
RO Saibe din cupru
F Patins en cuivre

I Set di spessori
E Arandelas de cobre
CN 件套紫铜垫片

PLASTIC
HANGING BOX



150
PCS

MIX
SIZE
ROZMIAROW

Cu



5x10x1 mm 10 pcs	8x11x1 mm 10 pcs	11x17x1.5 mm 10 pcs	12.5x20x1.5 mm 10 pcs	15x20x2 mm 10 pcs	16.5x24x2 mm 10 pcs
6x10x1 mm 10 pcs	10x16x1 mm 10 pcs	14x18x1 mm 10 pcs	14x20x1.5 mm 10 pcs	16x22x2 mm 10 pcs	17.5x24x2 mm 10 pcs
7x10x1 mm 10 pcs	10.5x17x1.5 mm 10 pcs	12x20x1.5 mm 10 pcs	12x20x1.5 mm 10 pcs	15x20x2 mm 10 pcs	17.5x24x2 mm 10 pcs

5x10x1.0 mm, 6x10x1.0 mm, 7x10x1.0 mm, 8x11x1.0 mm, 10x16x1.0 mm, 10.5x17x1.5 mm, 11x17x1.5 mm, 14x18x1.0 mm, 12x20x1.5 mm, 12.5x20x1.5 mm, 14x20x1.5 mm, 15x20x2.0 mm, 16x22x2.0 mm, 16.5x24x2.0 mm, 17.5x24x2.0 mm

YATO
YT-06871 5/20

GB Copper washer set
D Kupfer Dichtring Sortiment
PL Zestaw podkładek miedzianych
RUS Набор колец медных

CZ Podložky měděné těsnící
H Réz tömítés készlet
RO Saibe din cupru
F Patins en cuivre

I Set di spessori
E Arandelas de cobre
CN 件套紫铜垫片

PLASTIC BOX



300
PCS

MIX
SIZE
ROZMIAROW

METRIC
METRYCZNE

SOFT
TYPE
MIEKKI
MATERIAL

Cu



10x 5x9x1.0 mm	10x 8x14x1.5 mm	10x 12x16x1.0 mm	10x 14x20x1.5 mm	10x 18x24x1.5 mm	10x 22x29x1.5 mm
10x 6x10x1.0 mm	10x 9x14x1.0 mm	10x 12x16x1.5 mm	10x 14x20x2.0 mm	10x 20x24x1.5 mm	10x 24x29x1.5 mm
10x 6x12x1.0 mm	10x 10x14x1.0 mm	10x 12x18x1.5 mm	10x 16x20x1.5 mm	10x 20x24x0.8 mm	10x 24x32x2.0 mm
10x 8x12x1.0 mm	10x 10x14x1.5 mm	10x 13x18x1.0 mm	10x 16x22x1.5 mm	10x 19x26x2.0 mm	10x 26x34x2.0 mm
10x 8x14x1.0 mm	10x 10x16x1.0 mm	10x 14x18x1.5 mm	10x 18x22x1.5 mm	10x 22x27x1.0 mm	10x 28x36x2.0 mm

5x9x1.0 mm, 8x14x1.5 mm, 12x16x1.0 mm, 14x20x1.5 mm, 18x24x1.5 mm, 22x29x1.5 mm, 6x10x1.0 mm, 9x14x1.0 mm, 12x16x1.5 mm, 14x20x2.0 mm, 20x24.5x1.5 mm, 24x29x1.5 mm, 6x12x1.0 mm, 10x14x1.0 mm, 12x18x1.5 mm, 16x20x1.5 mm, 20x24.5x0.8 mm, 24x32x2.0 mm, 8x12x1.0 mm, 10x14x1.5 mm, 13x18x1.0 mm, 16x22x1.5 mm, 19x26x2.0 mm, 26x34x2.0 mm, 8x14x1.0 mm, 10x16x1.0 mm, 14x18x1.5 mm, 18x22x1.5 mm, 22x27x1.0 mm, 28x36x2.0 mm

YATO
YT-06872

5/20

GB Copper gasket & oil drain plug assortment
D Ölablassschraube Kupfer Schrauben und O-Ringe
PL Zestaw podkładek miedzianych i korków spustowych
RUS Набор медных шайб и сливных пробок поддона двигателя

CZ Sada měděných podložek a zátek pro olejové výpustě
H Olajteknő csavar és rézalátét készlet
RO Set busoane baie ulei
F Boulons de carter d'huile & assortiment bagues

I Set di rondelle in rame a spine
E Tornillos y juntas para tapon de carter
CN 534PC;油封

PLASTIC BOX



534
PCS

MIX
SIZE
ROZMIAROW

Cu



50x 6 mm	50x 8 mm	50x 10 mm	50x 12 mm	50x 13 mm	50x 14 mm
50x 15 mm	50x 16 mm	50x 18 mm	50x 20 mm	5x M8x1	5x M10x1
5x M12x1.5	5x G1/4	5x M14x1.5	3x M16x1.5	3x M18x1.5	3x M20x1.5

6 mm, 8 mm, 10 mm, 12 mm, 13 mm, 14 mm, 15 mm, 16 mm, 18 mm, 20 mm;
M8x1.0, M10x1.0, M12x1.5, M14x1.5, M16x1.5, M18x1.5, M20x1.5; G1/4

YATO
YT-06864

10

GB Bodywork nuts & screws assortment
D Sortiment Karosseriemutter mit Schrauben
PL Zestaw wkrętów i podkładek do karoserii
RUS Набор саморезов и металлических клипс для кузовных работ

CZ Tělo matice a šroub kit
H Karosszéria csavar és anya készlet
RO Set asamblare clema / holsuruburi
F Assortiment de vis et d'écrous cage

I Set viti e rondelle al corpo
E Body kit tornillo
CN 170件套螺丝U型圈组套

PLASTIC
HANGING BOX



170
PCS

MIX
SIZE
ROZMIAROW



M3, M4, M5, M6;

M3x8 mm, M4x16 mm,
M5x12 mm, M6x20 mm

YATO
YT-06780

5/20

GB Metric nuts & bolts assortment
D Metric Mutter und Bolzen Sortiment
PL Zestaw śrub, nakrętek, podkładek i wkrętów

RUS Набор винты / гайки / болты / шайбы
CZ Sada šroubů, matic, podložek
H Csavarkészlet
RO Set suruburi / piulite

F Ecrous et boulons métrique assortment
I Set di viti, dadi, rondelle e viti
E Tuercas y tornillos métrica surtido
CN 347PC机丝自攻

PLASTIC
HANGING BOX



347
PCS

MIX
SIZE
ROZMIARÓW



 32x 3 x 12 mm	 26x 3 x 20 mm	 13x 5 x 24 mm	 43x 2.5 x 12 mm	 32x 3 x 19 mm	 10x 4 x 24 mm
 59x M5	 19x M6	 19x M5 x 25 mm	 24x M5 x 20 mm	 11x M6 x 20 mm	 10x M6

3x12 mm, 3x20 mm, 5x24 mm; 2.5x12 mm, 3x19 mm, 4x24 mm;
M5, M6; M5x20 mm, M5x25 mm, M6x20 mm;
M5, M6

YATO	
YT-06771	6/24

GB Clevis pin assortment
D Bolzen mit Kopf
PL Zestaw sworzni z łbem i otworem
RUS Набор штифтов с отверстиями под шплинт

CZ Čepy s hlavou
H Csapszeget kit
RO Set bolturi pt. securizare
F Axe de chape

I Set di perni con testa e il foro
E Kit de pasador de horquilla
CN 60PC销柱

PLASTIC
HANGING BOX



60
PCS

MIX
SIZE
ROZMIARÓW

5-12
mm



5x25 mm, 6x25 mm, 6x30 mm, 6x40 mm, 6x45 mm, 6x50 mm,
6x60 mm, 6x65 mm, 8x25 mm, 8x30 mm, 8x40 mm, 8x45 mm,
8x50 mm, 8x60 mm, 8x65 mm, 8x70 mm, 10x25 mm, 10x40 mm,
10x50 mm, 12x40 mm, 12x50 mm

YATO	
YT-06786	4/16

GB Grease nipple set
D Schmiernippel
PL Zestaw smarowniczek
RUS Набор масленок

CZ Sady mazacích hlavíc
H Zsírógomb (zsírzófej) készlet
RO Set gresoare metalice
F Set de graisseurs métriques

I Set grasso capezzoli
E Engrasador
CN 件套黄油嘴组套

PLASTIC
HANGING BOX



110
PCS

METRIC
METRYCZNE



 M6x1	 M6x1 45° 5 pcs	 M8x1 10 pcs	 M8x1 90° 5 pcs	 M10x1 90° 5 pcs	 M10x1 10 pcs
 M6x1 90° 60 pcs	 M6x1 90° 5 pcs	 M8x1 45° 5 pcs	 M10x1 45° 5 pcs		

M6x1, M6x1 45°, M6x1 90°, M8x1, M8x1 45°, M8x1 90°, M10x1, M10x1 45°, M10x1 90°

YATO	
YT-06888	5/20

GB Aluminium rivet assortment
 D Aluminium Blindnieten Sortiment
 PL Zestaw aluminiowych nitów zrywalnych

RUS Набор заклепок
 CZ Sada hliníkové nity
 H Csőves alumínium szegecsek
 RO Set popniruri

F Rivets tubulaires en aluminium
 I Set di rivetto alluminio
 E Remaches tubulares de aluminio
 CN 400件套铆钉组套

PLASTIC HANGING BOX



400 PCS

MIX SIZE ROZMIAŃ

AI



2.4, 3.2, 4.0, 4.8 mm

YATO YT-36420 5/20

GB Spring assortment
 D Schraubenfeder Sortiment
 PL Zestaw sprężynek
 RUS Набор пружинок оцинкованных

CZ Sada pružin
 H Rugó készlet
 RO Arcuri tensiune
 F Assortiment ressorts

I Set di molle
 E Caja surtido de de resortes
 CN 件套弹簧组套

PLASTIC HANGING BOX



200 PCS

MIX SIZE ROZMIAŃ



10 pcs 7.0 x 12.5 mm 5.0 x 20.5 mm	6 pcs 9.5 x 16.0 mm 8 pcs 8.0 x 28.5 mm	12 pcs 8.5 x 47.0 mm 8.0 x 44.5 mm	8 pcs 4.5 x 44.5 mm 9.0 x 35.0 mm	10 pcs 5.5 x 38.0 mm
10 pcs 6.5 x 10.0 mm 5.5 x 25.5 mm	12 pcs 9.5 x 19.0 mm	12 pcs 7.0 x 51.0 mm 4.0 x 79.5 mm	10 pcs 7.0 x 38.0 mm	10 pcs 8.5 x 36.5 mm 7.0 x 19.0 mm

YATO YT-06875 5/20

GB Hitch pin assortment set
 D Sortiment Federsplinte
 PL Zestaw zawleczek sprężystych
 RUS Набор шплинтов с фиксацией

CZ Pružinové závlačky
 H Rugós csap
 RO Set sigurante securizare
 F Assortiment goupilles beta

I Set di spine elastiche
 E Pasadores surtido beta
 CN 150PC R型销

PLASTIC HANGING BOX



150 PCS

6 SIZES ROZMIAŃ



2.4x31 mm, 2x33 mm, 2x40 mm,
 2.8x42 mm, 3.5x45 mm, 4x75 mm

YATO YT-06883 6/24

GB Splint pin assortment
D Splinte Sortiment
PL Zestaw zawleczek prostych
RUS Набор шплинтов

CZ Set závlačky
H Saszeg készlet
RO Cuie spintecate mici
F Goupilles - goupille fendue

I Set di perni
E Dividir cotter pinos
CN 件套开口销组套

PLASTIC
HANGING BOX



555
PCS

MIX
SIZE
ROZMIAROW



 1.6x25 mm, 2.4x25 mm, 2.4x38 mm,
3.2x32 mm, 3.2x50 mm, 4.0x64 mm

YATO  
YT-06873 5/10

GB Splint pin assortment
D Splinte Sortiment
PL Zestaw zawleczek prostych
RUS Набор шплинтов

CZ Set závlačky
H Saszeg készlet
RO Cuie spintecate mici
F Goupilles - goupille fendue

I Set di perni
E Dividir cotter pinos
CN 件套开口销组套

PLASTIC
HANGING BOX



1000
PCS

MIX
SIZE
ROZMIAROW



 1.5x25 mm, 2.4x25 mm, 2.4x38 mm,
3.0x32 mm, 3.0x50 mm, 4.0x60 mm

YATO  
YT-06885 12

GB E-ring circlips assortment
D Sortiment E-Sicherungsringe
PL Zestaw zawleczek typu „E”
RUS Набор Э-образных
стопорных колец

CZ Otevření pojistný kroužek
H „E” klip választék készlet
RO Set inele seger alezaj
F „E” clip assortment kit

I Set di spine tipo „E”
E E-ring anillo
de retención variedad
CN 卡簧

PLASTIC
HANGING BOX



300
PCS

1.5-22
mm

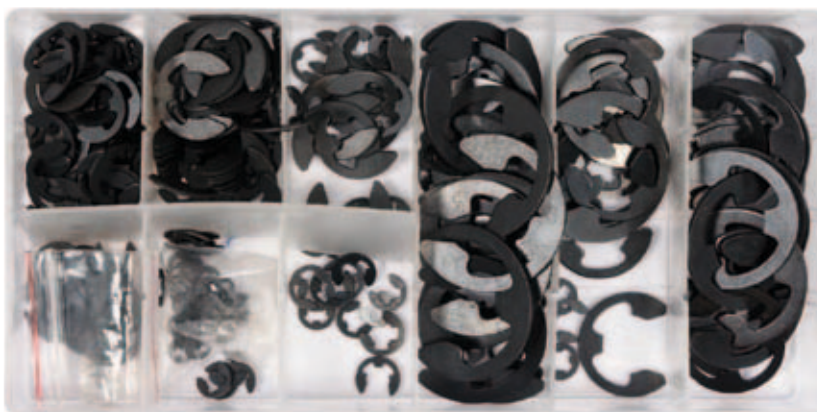

 1.5 mm, 3 mm, 5 mm, 6 mm, 10 mm,
12 mm, 15 mm, 19 mm, 22 mm

YATO  
YT-06884 25

GB Linch-pins assortment
D Klappsplint Sortiment
PL Zestaw zawleczek z kółkiem
RUS Набор шплинтов с кольцом

CZ Kolík pojistný
H Rugos biztosítoszeg készlet
RO Set pini pt. securizare
F Assortiment goupille clip

I Set di perni dalla ruota
E Pasador clip
CN 50件套弹性销组套

PLASTIC BOX



50
PCS

MIX
SIZE
ROZMIAROW

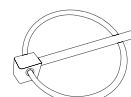

Ø 4.5x36 mm, Ø 6.0x45 mm,
Ø 8.0x45 mm, Ø 11.0x45 mm

YATO
YT-06787 6/12

GB Hose clamp assortment
D Schlauchschelle Sortiment
PL Zestaw obejm ślimakowych
RUS Набор хомутов

CZ Spony stahovac na hadice sada
H Tömélbilincs csőszerelés szett
RO Coliere furtun
F Colliers de serrage universels

I Fascetta assortmento
E Manguera helicoidal instalación de tuberías abrazadera conjunto
CN 26件套喉箍

PLASTIC HANGING BOX



26
PCS

MIX
SIZE
ROZMIAROW

16-40
mm



16, 22, 25, 28, 35, 40 mm

YATO
YT-06782 5/20

16

GB External / internal circlip assortment
D Aussen / Innen seegerring sortiment
PL Zestaw pierścieni Segera wewnętrznych / zewnętrznych
RUS Набор стопорных колец

CZ Sada vnitřní / vnější kroužky
H Állítsa belső / külső seeger-gyűrű
RO Set inele seger arbore
F Externe / interne assortiment de circlip

I Set all'esterno / all'interno degli anelli Segera
E Sortimento freio externo / interno
CN 225件套外挡圈

PLASTIC HANGING BOX



225
PCS

MIX
SIZE
ROZMIAROW

EXTERNAL
ZEWNETRZNE

INTERNAL
WEWNETRZNE

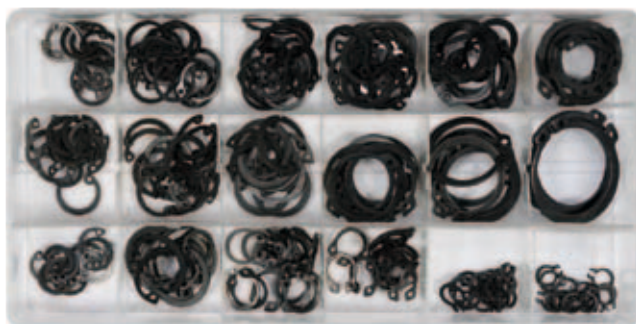

10x Ø 13 mm	15x Ø 13 mm	15x Ø 14 mm	15x Ø 16 mm	15x Ø 19 mm	10x Ø 20 mm
10x Ø 14 mm	15x Ø 18 mm	10x Ø 19 mm	10x Ø 22 mm	10x Ø 25 mm	5x Ø 32 mm
15x Ø 11 mm	10x Ø 20 mm	15x Ø 11 mm	15x Ø 9 mm	15x Ø 8 mm	15x Ø 6 mm

INTERNAL / WEWNETRZNE: Ø 11, 13, 14, 16, 19, 20 mm
EXTERNAL / ZEWNETRZNE: Ø 6, 8, 9, 11, 13, 14, 16, 19, 20, 22, 25, 32 mm

YATO
YT-06882 5/20

GB External circlip assortment
D Aussen-seegerring-sortiment
PL Zestaw pierścieni segera zewnętrznych
RUS Кольца стопорные внешние
CZ Sada pojistné kroužky
H Külső seeger-gyűrű készlet

RO Set agrafe
F Set de circlips ext.
I Set all'esterno degli anelli Segera
E Anillos seeger para agujeros exteriores
CN 件套外挡圈组套

PLASTIC
HANGING BOX



300
PCS



Ø 3, 4, 5, 6, 8, 9, 11, 12, 13, 14, 15, 19, 20, 22, 25, 26, 28, 32 mm

YATO 	
YT-06880	5/20

GB Internal circlip assortment
D Innen-seegerring-sortiment
PL Zestaw pierścieni segera wewnętrznych
RUS Кольца стопорные внутренние
CZ Sada pojistné kroužky
H Belső seeger-gyűrű készlet

RO Set agrafe
F Set de circlips int.
I Set all'interno degli anelli Segera
E Anillos seeger para agujeros interiores
CN 件套内挡圈组套



PLASTIC
HANGING BOX



300
PCS



Ø 3, 4, 5, 6, 8, 9, 11, 12, 13, 14, 15, 19, 20, 22, 25, 26, 28, 32 mm

YATO 	
YT-06881	5/20

GB Feather keys assortment
D Sortiment Federkeile
PL Zestaw klínów półokrągłych
RUS Шпонки полукруглые

CZ Sada klínů polokruhových
H Ives hornyok biztosítására
RO Set pene disc pt. imbinari arbore
F Aspérule clés assortment

I Set di cunei semicirculari
E Surtido de chavetas media luna
CN 键销

PLASTIC
HANGING BOX



80
PCS



 3.0x5.0x13 mm, 3.0x6.5x16 mm, 4.0x5.0x13 mm,
4.0x6.5x16 mm, 4.0x7.5x19 mm, 5.0x7.5x19 mm,
5.0x9.0x22 mm, 6.0x9.0x22 mm

YATO 	
YT-06790	5/20

GB Socket head set screw assortment metric
D Sortiment Madenschrauben, metrisch
PL Zestaw śrub imbusowych bez łba
RUS Набор винтов установочных с плоским концом

CZ Šroub stavěcí, plochý konec, bez úpravy
H Set menetes sasszegekkel
RO Set splituri filetate
F Set clavettes de vis

I Set di viti esagonali senza testa
E Conjunto de tornillo chavetas
CN 160件套无头螺钉组套

PLASTIC HANGING BOX



160
PCS

MIX
SIZE
ROZMĚRŮ



3x5 mm, 4x5 mm, 5x6 mm, 6x6 mm, 6x6 mm F, 6x10 mm, 8x10 mm, 8x10 mm F, 8x12 mm, 10x10 mm, 10x10 mm F, 10x12 mm

YATO	
YT-06777	5/20

GB Rubber Grommet Assortment
D Gummi-durchgangs-tullen sortiment
PL Zestaw przelotek gumowych
RUS Набор резиновых втулок

CZ Gumové průchodka
H Gumi grommet készlet
RO Presetupa cauciu pt. cablu
F Coffret passe-cloison caoutchouc

I Gommino angello
E Caja surtido de pasamuros de goma
CN 件套垫圈组套

PLASTIC HANGING BOX



180
PCS

MIX
SIZE
ROZMĚRŮ



5 PCS D= 22.0 mm ID= 15.0 mm OD= 28.0 mm	40 PCS D= 9.5 mm ID= 6.0 mm OD= 13.0 mm	5 PCS D= 15.8 mm ID= 12.0 mm OD= 19.0 mm	40 PCS D= 7.9 mm ID= 5.0 mm OD= 10.0 mm	25 PCS 	5 PCS D= 25.4 mm ID= 17.0 mm OD= 32.0 mm
		40 PCS D= 6.3 mm ID= 3.0 mm OD= 8.0 mm	20 PCS D= 12.7 mm ID= 11.0 mm OD= 15.0 mm	D= 11.0 mm ID= 9.0 mm OD= 15.0 mm	

YATO	dimensions / wymiary (mm)	
YT-06778	6.3; 7.9; 9.5; 11.0; 12.7; 15.8; 22.0; 25.4	5/20

GB Roll pin assortment
D Hohlspannstifte Spannsteife Sortiment
PL Zestaw kolków sprężystych
RUS Набор штифтов разрезных пружинных цилиндрических

CZ Pružné válcové kolíky se štěrbinou
H Rugalmas hengeres csapok a nyílásba
RO Set splituri elastice
F Rouleau broche / pin assortiment de printemps

I Perno del rullo assortimento
E Acero pasador elástico
CN 315件套热收缩管组套

PLASTIC HANGING BOX



315
PCS

MIX
SIZE
ROZMĚRŮ



1.5x5mm, 1.5x8mm, 1.5x20mm, 2x6mm, 2x12mm, 2x25mm, 2.5x16mm, 2.5x25mm, 2.5x30mm, 3x16mm, 3x25mm, 3x30mm, 4x16mm, 4x25mm, 4x40mm, 5x16mm, 5x25mm, 5x30mm, 5.5x16mm, 5.5x30mm, 5.5x45mm, 6x16mm, 6x30mm, 6x45mm, 8x20mm, 8x40mm, 8x50mm, 10x20mm, 10x40mm, 10x50mm

YATO	
YT-06785	5/20

GB O-ring assortment
D O-ring Sortiment
PL Zestaw O-ringów gumowych
RUS Набор резиновых прокладок

CZ Gumové „o“ kroužky sada
H O gyűrű készlet
RO Garnituri din cauciuc
F Set d'o-rings en caoutchouc

I Set guarnizioni O-ring
E Kit de junta tórica
CN 件套O型圈组套

PLASTIC
HANGING BOX



225
PCS

HEAT RESISTANT
TEMPERATURAOOPORNE

OIL, PETROL,
CHEMICAL
RESISTANT
ODPORNE NA OLEJ,
BENZYNIE,
CHEMICALIA



3x1 mm ○ 20 pcs	4x1 mm ○ 20 pcs	4,5x2 mm ○ 20 pcs	5x2 mm ○ 20 pcs	6x2 mm ○ 20 pcs	6x2,5 mm ○ 20 pcs
13x3 mm ○ 5 pcs	14x2,5 mm ○ 5 pcs	17x2,5 mm ○ 5 pcs	18x4 mm ○ 5 pcs	20x2 mm ○ 5 pcs	22x2 mm ○ 5 pcs
6x3 mm ○ 20 pcs	7x2 mm ○ 20 pcs	8x2 mm ○ 20 pcs	9x2 mm ○ 5 pcs	10x2 mm ○ 5 pcs	12x3 mm ○ 5 pcs

YATO
YT-06877

5/20

GB O-Rings assortment for air conditioning
D O-Ringe für die Klimaanlage
PL Zestaw O-ringów HNBR do klimatyzacji
RUS Набор резиновых прокладок для систем кондиционирования воздуха

CZ Gumový kroužek set klimatizace
H Gumi gyűrű készlet légkondicionáló
RO Inele pt. aer condiționat
F Cercle en caoutchouc boîte de kit combinaison

I O-Ring assortimento per l'aria condizionata
E Kit círculo caucho combinación caja
CN 270PC 绿色O型圈

PLASTIC
HANGING BOX



270
PCS

MIX
SIZE
ROZMIAROW

HNBR
MATERIAL



20x ∅ 5,29 x 1,78 mm	20x ∅ 6,07 x 1,78 mm	20x ∅ 6,8 x 1,9 mm	20x ∅ 7,65 x 1,78 mm	20x ∅ 7,8 x 1,9 mm	20x ∅ 8 x 2 mm
20x ∅ 8,8 x 1,9 mm	15x ∅ 10,82 x 1,78 mm	15x ∅ 10,77 x 2,62 mm	15x ∅ 11 x 2 mm	15x ∅ 12 x 2 mm	10x ∅ 13,9 x 1,8 mm
10x ∅ 13,95 x 2,62 mm	10x ∅ 10 x 2 mm	10x ∅ 15 x 2 mm	10x ∅ 17 x 2 mm	10x ∅ 17,17 x 1,78 mm	10x ∅ 17,04 x 3,53 mm

∅ 5.29 x 1.78 mm, 6.07 x 1.78 mm, 6.8 x 1.9 mm, 7.65 x 1.78 mm, 7.8 x 1.9 mm, 8 x 2 mm, 8.8 x 1.9 mm, 10.82 x 1.78 mm, 10.77 x 2.62 mm, 11 x 2 mm, 12 x 2 mm, 13.9 x 1.8 mm, 13.95 x 2.62 mm, 10 x 2 mm, 15 x 2 mm, 17 x 2 mm, 17.17 x 1.78 mm, 17.04 x 3.53 mm

YATO
YT-06879

6/24

GB O-ring assortment
D O-ring Sortiment
PL Zestaw O-ringów gumowych
RUS Набор резиновых прокладок

CZ Gumové „o“ kroužky sada
H O gyűrű készlet
RO Garnituri din cauciuc
F Set d'o-rings en caoutchouc

I Set guarnizioni O-ring
E Kit de junta tórica
CN 件套O型圈组套

PLASTIC BOX



419
PCS

MIX
SIZE
ROZMIAROW

NBR
MATERIAL

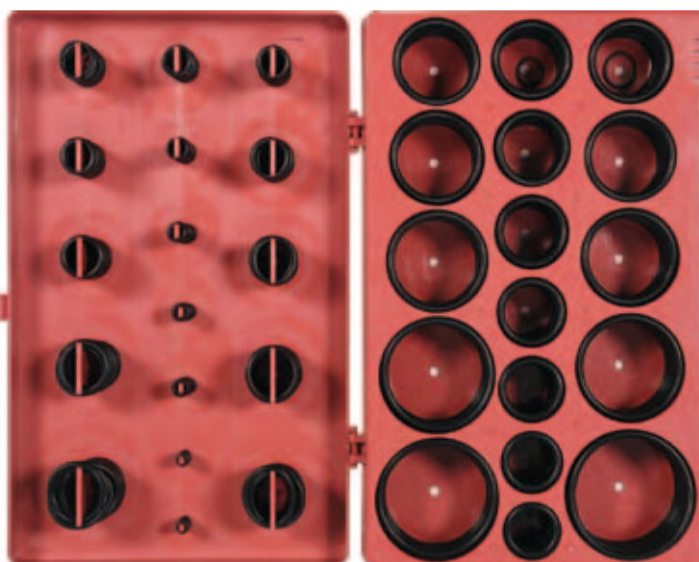

3x1.5 mm, 4.4x2 mm, 5x2 mm, 7x1.5 mm, 10x1.5 mm, 10x2.5 mm, 11x2.5 mm, 13x1.5 mm, 13x2.5 mm, 14x2.5 mm, 16x2.5 mm, 18x2.5 mm, 19x2.5 mm, 21x2.5 mm, 22x2.5 mm, 18x3.5 mm, 20x3.5 mm, 22x3.5 mm, 23.5x3.5 mm, 25x3.5 mm, 26.5x3.5 mm, 28x3.5 mm, 30x3.5 mm, 31x3.5 mm, 33x3.5 mm, 34.5x3.5 mm, 36x3.5 mm, 38x3.5 mm, 41x3.5 mm, 44x3.5 mm, 47x3.5 mm, 50x3.5 mm

YATO
YT-06876

24

- | | | |
|-------------------------------------|-----------------------------------|--|
| GB Heat-shrink tubing set | CZ Smršťovací bužírka tepelné | I Tubo termoretraibile per isolare |
| D Schrumpfschlauch - Sortiment | H Hőre zsugorodó cső szettek | E Surtido tubo de conexión eléctrica cable manga |
| PL Zestaw koszulek termokurczliwych | RO Set tuburi termocontractabile | CN 件套热收缩管 |
| RUS Набор термоусадочных трубок | F Gaine thermoretractable coffret | |

PLASTIC HANGING BOX



127 PCS MIX SIZE ROZMIAROW 125°C max. 600 V max.



Ø 2.0 x 40, 2.5 x 40, 3.5 x 40, 5.0 x 40, 7.0 x 80, 10.0 x 80, 13.0 x 85 mm

YATO	
YT-06866	5/20

- | | | |
|---|----------------------------|-----------------------------|
| GB Terminal connectors | RUS Набор экспресс-клемм | F Connecteur rapide |
| D Kabelschuhe schnellkupplung kabelklemme | CZ Kabelova rychlospojka | I Connettori terminali |
| PL Zestaw szybkozłączy elektrycznych | H Gyors csatlakozó auto | E Conector rapido electrico |
| | RO Conector rapid pt. auto | CN 件套连接片组套 |

PLASTIC HANGING BOX



50 PCS MIX SIZE ROZMIAROW

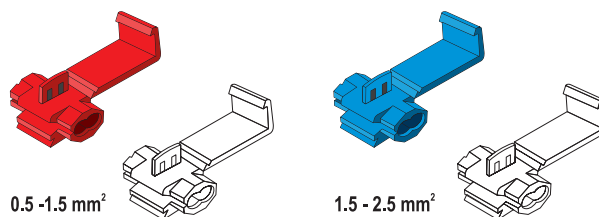

YATO	dimensions / wymiary (mm²)	
YT-06868	0.5 - 1.5; 1.5 - 2.5	5/20

- | | | |
|---|--|-----------------------------------|
| GB Electrical clip assortment | CZ Terminal alligator krokodil přichytek | I Set di perni per misure e prove |
| D Krokodil-Klemmen-Kortiment | H Krokodil csipesz készlet | E Crocodile clip |
| PL Zestaw złączy elektrycznych - krokodylki | RO Sortiment cleme crocodil | CN 件套夹头组套 |
| RUS Набор разъемов - крокодил | F Assortiment pinces crocodile | |

PLASTIC HANGING BOX



28 PCS MIX SIZE ROZMIAROW



10 pcs / sztuk - Alligator - clip without insulation / Krokodylki nieizolowane
 6 pcs / sztuk - Alligator - clip insulation / Krokodylki izolowane
 4 pcs / sztuk - Big charging clip insulation / Zaciski duże izolowane
 6 pcs / sztuk - Mini alligator - clip / Krokodylki małe izolowane
 2 pcs / sztuk - Small charging clip insulation / Zaciski małe izolowane

YATO	dimensions / wymiary (mm)	
YT-06870	50; 55; 60; 65; 70; 80	5/20

Memo

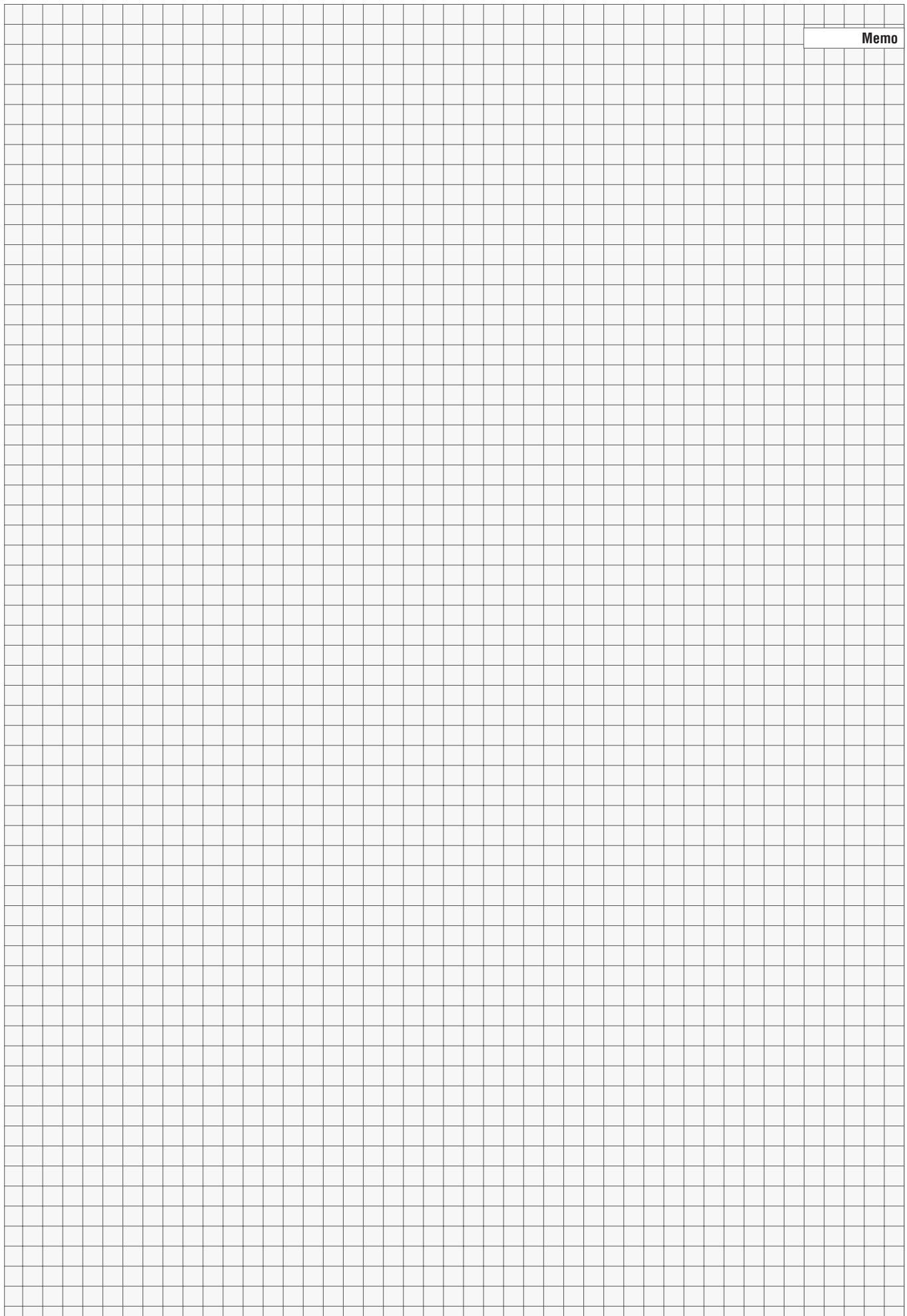

17

Welding equipment & accessories Narzędzia spawalnicze i akcesoria



Welding helmets & accessories
Przyłbice spawalnicze i akcesoria

396



Profile connection & forming pliers
Szcypce do łączenia i kształtowania profili

400



Ball peen hammers & sets
Młotki blacharskie i zestawy

397



Spot weld cutter sets
Zestawy rozwiertaków do zgrzewów

400



Dead blow hammers
Młotki bezodrzutowe

397



Combination edge setters & hole punch pliers
Dziurkarko-felcarki

400



Lock grip pliers
Szcypce zaciskowe

398-399



Magnetic holders
Wsporniki magnetyczne

401



Self-locking multi grip pliers

Szcypce blacharskie..... 398

Welding locking pliers

Szcypce zaciskowe, spawalnicze..... 399

Flat locking pliers

Szcypce zaciskowe o szerokich szczękach..... 399

C-type welding locking pliers

Szcypce zaciskowe, kłamrowe typu „C”..... 399

Chain locking pliers

Szcypce zaciskowe z łańcuchem..... 399

Tin snips

Nożyce do blachy

402-405



GB Auto-darkening welding helmet
 D Schweißsmaske, selbstverdunkelnd
 PL Przyłbica spawalnicza samościemniająca
 RUS Маска для сварки, самостоятельно затемняющаяся
 CZ Svářečská kukla samostmívací
 H Ónmagától sötétedő hegesztőpajzs

RO Mască de sudură auto-întunecare
 F Masque de soudage
 I Oscuramento casco di saldatura
 E Casco auto-oscurecedor para soldadura
 CN 工具车双挂板

COLOR BOX



DARK STATE STAN CIEMNY 9-13	LIGHT STATE STAN JASNY 4	REACTION TIME CZAS REAKCJI 1/25000 s	BRIGHTENING TIME CZAS ROZJAŚNIANIA 0,1-1,0 s
FILTER TEST TEST FILTRA		LOW BATTERY ALARM WSKAZNIK POZIOMU BATERII	
2x3V CR2045 BATTERIES NOT INCLUDED BATERII NIE SĄ DOŁĄCZONE		WORKING TEMPERATURE TEMPERATURA PRACY -5°C + +55°C	

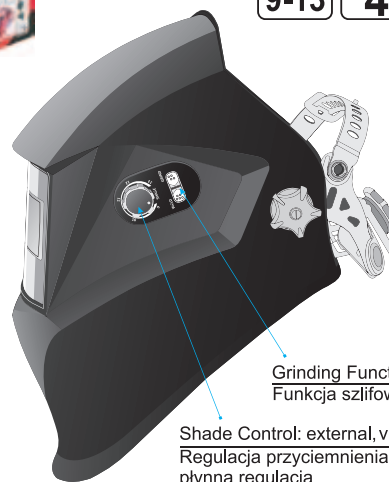

Grinding Function: YES
Funkcja szlifowania: TAK

Shade Control: external, variable
Regulacja przyciemnienia: zewnętrzna, płynna regulacja

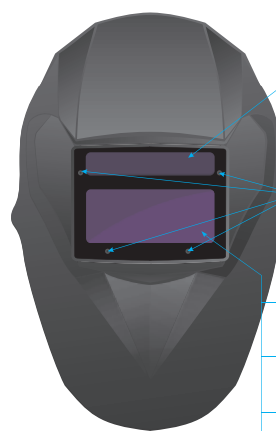

Solar cell filter power supply during welding
Ogniowo słoneczne zasilanie filtra podczas spawania

Arc Sensor: 4
Liczba czujników łuku: 4

Viewing Area: 98x43 mm
Obszar pola widzenia: 98x43 mm

UV/IR Protection
Ochrona przed promieniowaniem UV/IR

Automatic power on / off
Automatyczne włączenie / wyłączenie

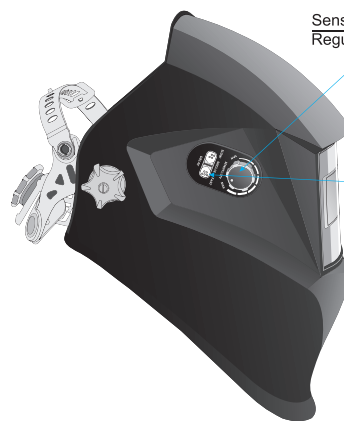

Sensitivity Control
Regulacja czułości

The rate of dimming
Szybkość ściemniania
0.3 - 1.0 ms

- EN 379
- optical class: 1 / 1 / 1 / 1
- cover lens YT-73924 included
- klasa optyczna: 1 / 1 / 1 / 1
- w zestawie szybki ochronne YT-73924

YATO	
YT-73921	6

TYPE FC-11 EN 166:2001 B

5 PCS	123x98 mm	PC
-----------------	---------------------	-----------

for / dla: YT-73921

POLYBAG WITH HEADER

YATO	
YT-73924	20/160

4 POINT HEADGEAR
WIĘŻBA 4 PUNKTOWA

Lock into a detent when lifted
Blokada w pozycji podniesionej

3 position slider to adjust the distance from eyes to lens
3 pozycje regulacji odległości od filtra

Regulation at the occipital area
Regulacja pozycji potylicznej

Ratchet with soft rubber grip to adjust size without removing the helmet
Regulacji obwodu za pomocą systemu grzechotkowego

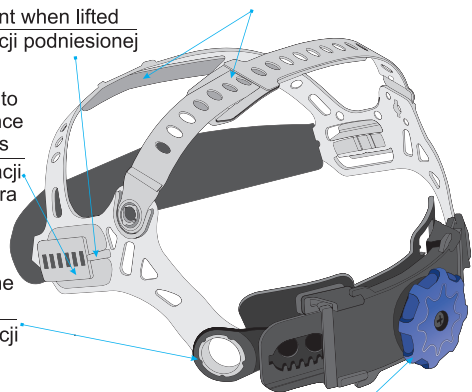

2-point crown strap adjustment to rise or lower the helmet
2 punktowa regulacja wysokości

GB Front cover lens
D Außerschutzglas
PL Szybka ochronna do przyłbicy samościemniającej
RUS Стекло защитное наружное
CZ Přední krycí sklíčko
H Kűlső védőlemez
RO Protecția exterioră de plastic
F Verres de protection
I Martello per lamiera
E Cubierta de la lente de soldadura
CN 前盖镜片



- GB Auto body fender set
D Karosserie-Ausbeulsatz
PL Komplet młotków blacharskich
RUS Молотки рихтовочные
CZ Souprava klempířských kladívek
H Bádogos kalapács készlet
RO Set de ciocane de tablă
F Set pour carrossier
I Martello per lamiera
E Juego de mazos de hojalatero
CN 钣金工具组套



7
PCS

DROP
FORGED
KUTE

GENUINE
HICKORY

BMC
& COLOR
SLEEVE



YATO	m (g)	
YT-4590	4900	4

- GB Ball pein hammer
D Ausbeulhammer
PL Młotek blacharski
RUS Молоток рихтовочный
CZ Klempířské kladívko
H Bádogos kalapács
RO Ciocan pt. tablă
F Marteau à panne ronde
I Martello per lamiera
E Martillo de hojalatero
CN 圆头锤



FIBREGLASS
WŁÓKNO
SZKLANE

YATO	m (g)	L (mm)	A (mm)	H (mm)	
YT-4515	225	280	26	80	6/36
YT-4516	450	315	34	100	6/24
YT-4518	900	380	40	125	6/12

- GB Ball pein hammer
D Ausbeulhammer
PL Młotek blacharski
RUS Молоток рихтовочный
CZ Klempířské kladívko
H Bádogos kalapács
RO Ciocan pt. tablă
F Marteau à panne ronde
I Martello per lamiera
E Martillo de hojalatero
CN 圆头锤

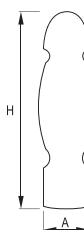

YATO	m (g)	L (mm)	A (mm)	H (mm)	
YT-4519	225	295	26	80	6/36
YT-4520	450	335	35	100	6/24
YT-4521	680	360	36	115	6/12
YT-4522	900	380	40	125	6/12

- GB Dead blow mallet
D Rückschlagsfreier
Schonhammer
PL Młotek bezodrztowy
RUS Молоток безинерционный
CZ Palička nárazová plněná
celogumová
H Visszarúgás mentes
gumikalapács
RO Ciocan cu absorbție
F Maillet sans recul
I Martello morto colpo
E Martillo sin reacción
CN 防震无回弹橡胶锤



PU

YATO	m (g)	L (mm)	Ø (mm)	H (mm)	
YT-4624	265	318	30.0	94	10/40
YT-4625	430	350	40.0	100	6/36
YT-4626	490	348	45.0	110	6/36

- GB Dead blow mallet
D Rückschlagsfreier
Schonhammer
PL Młotek bezodrztowy
RUS Молоток безинерционный
CZ Palička nárazová
plněná celogumová
H Visszarúgás mentes
gumikalapács
RO Ciocan cu absorbție
F Maillet sans recul
I Martello morto colpo
E Martillo sin reacción
CN 防震无回弹橡胶锤



PU

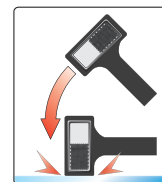

YATO	m (g)	L (mm)	Ø (mm)	H (mm)	
YT-4620	740	300	44.5	100.0	4/24
YT-4622	900	336	53.5	100.0	4/24
YT-4623	1300	350	59.0	118.5	3/12

- GB PU & nylon heads mallet
D Schonhammer
mit PU & Nylon-Schlagkopf
PL Młotek blacharski
RUS Молоток рихтовочный
CZ Palička klempířská
H Vaskalapács
RO Ciocan tinichigerie
cap PU / nylon
F Marteau spécial
en PU / nylon
I Martello per lamiera
E Martillo chapista
CN 木柄安装锤



PU

NYLON

YATO	m (g)	L (mm)	Ø (mm)	H (mm)	
YT-4630	150	250	22	75	6/48
YT-4631	250	280	28	85	6/36
YT-4632	340	315	35	95	6/36
YT-4633	660	350	45	105	6/24
YT-4634	1340	380	60	132	4/16

GB Self-locking multi grip pliers
 D Grip-Festhaltezeange
 PL Szczypce blacharskie
 RUS Зажим ручной сварочный
 для закрепления лент и профилей
 CZ Kleště klempířské samodržící

H Önzáró rögzítőfogó
 RO Cleste autoblocant pt. tinichigerie
 F Pince pour tôle
 I Pinze per lamiera
 E Pinzas de chapa
 CN 多功能大力钳

200 mm 0-15 mm 70 mm TYPE W CrMo



SLIDING CARD

YATO	L (mm)	
YT-2160	200	12/24

GB Self-locking multi grip pliers
 D Grip-Festhaltezeange
 PL Szczypce blacharskie
 RUS Зажим ручной сварочный
 для закрепления лент и профилей
 CZ Kleště klempířské samodržící

H Önzáró rögzítőfogó
 RO Cleste autoblocant pt. tinichigerie
 F Pince pour tôle
 I Pinze per lamiera
 E Pinzas de chapa
 CN 多功能大力钳

230 mm 0-15 mm 45 mm TYPE JJ CrMo



SLIDING CARD

YATO	L (mm)	
YT-2161	230	12/24

GB Self-locking multi grip pliers
 D Grip-Festhaltezeange
 PL Szczypce blacharskie
 RUS Зажим ручной сварочный
 для закрепления лент и профилей
 CZ Kleště klempířské samodržící

H Önzáró rögzítőfogó
 RO Cleste autoblocant pt. tinichigerie
 F Pince pour tôle
 I Pinze per lamiera
 E Pinzas de chapa
 CN 多功能大力钳

215 mm 0-10 mm 45 mm TYPE LL CrMo



SLIDING CARD

YATO	L (mm)	
YT-2162	215	12/36

GB Self-locking multi grip pliers
 D Grip-Festhaltezeange
 PL Szczypce blacharskie
 RUS Зажим ручной сварочный
 для закрепления лент и профилей
 CZ Kleště klempířské samodržící

H Önzáró rögzítőfogó
 RO Cleste autoblocant pt. tinichigerie
 F Pince pour tôle
 I Pinze per lamiera
 E Pinzas de chapa
 CN 多功能大力钳

210 mm 0-15 mm 25 mm TYPE J CrMo



SLIDING CARD

YATO	L (mm)	
YT-2163	210	12/36

- GB Sliding arm welding locking pliers
D Parallel-gripzange
PL Szybkonastawne szczypce spawalnicze
RUS Образная струбина с захватом
CZ Paralelné samosvorné kleště
H Szorítórúdas önzáró fogó
RO Clește de mana cu prindere tip menhina
F Pince-étau - serre-joint coulissant
I Scorrevole pinze di bloccaggio di saldatura braccio
E Pinzas de presión tipo sargento
CN C型滑杆大力钳

260 mm 0-150 mm

QUICK-ADJUSTMENT
SZYBKONASTAWNY



HALF
DOUBLE
BLISTER

YATO	L (mm)	
YT-21570	260	2/16

- GB Welding locking pliers
D Klemmzange zum Schweißen
PL Szczypce zaciskowe spawalnicze
RUS Клеши давяльные сварочные
CZ Kleště samosvorné svářečské
H Hegesztő fogó
RO Clește de strângere pt. sudură
F Pincés de serrage pour soudeur
I Pinze di bloccaggio per saldatura
E Pinzas de tornillo (de apriete) para soldar
CN 焊接用大力钳

HALF
DOUBLE
BLISTER



225 mm

TYPE
U



YATO	L (mm)	
YT-2461	225	6/24

- GB Flat locking pliers
D Klemmzange mit breiten Backen
PL Szczypce zaciskowe o szerokich szczękach
RUS Клеши давяльные с широкими губками
CZ Kleště samosvorné se širokými čelistmi
H Lapos fogó
RO Clește de strângere plat / patent
F Pince de serrage large
I Pinze con ganasce piane e paletta
E Pinzas de tornillo (de apriete) con mordazas anchas
CN 铁皮大力钳

HALF
DOUBLE
BLISTER



200 mm

0-12.7 mm

78 mm



YATO	L (mm)	
YT-2463	200	6/24

- GB C-type welding locking pliers
D Klemm- und Klammerzange vom Typ „C“
PL Szczypce zaciskowe klamrowe typu „C“
RUS Клеши давяльные типа „C“
CZ Kleště samosvorné upínací typu „C“
H „C“ fogó
RO Clește de strângere cu clemă tip „C“
F Pince de serrage type „C“
I Pinze di bloccaggio tipo „C“
E Pinzas de tornillo (de apriete) de grapa tipo „C“
CN C型大力钳

HALF
DOUBLE
BLISTER



280 mm

0-100 mm

TYPE
C



YATO	L (mm)	
YT-2466	280	6/24

YATO	L (mm)	
YT-2468	280	6/24

- GB Chain locking pliers
D Klemmzange mit Kette
PL Szczypce zaciskowe z łańcuchem
RUS Клеши давяльные с цепью
CZ Kleště samosvorné s řetězem
H Láncos csőfogó
RO Clește de strângere cu lanț
F Pince de serrage avec une chaîne
I Pinze di bloccaggio con la catena
E Pinzas de tornillo (de apriete) con cadena
CN 链条大力钳

HALF
DOUBLE
BLISTER



500 mm

40 Mn



YATO		
YT-2469		6/24

GB Profile connection pliers
 D Zange zum Verbinden der Profile
 PL Szczypce do łączenia profili
 RUS Щипцы для соединения профилей
 CZ Kleště ke spojování profilů
 H Profílegyesítő fogó
 RO Cleste pt. imbinarea profilelor
 F Pince pour sertir les profiles
 I Pinze per la unione profili
 E Pinzas para conectar perfiles
 CN 龙骨钳



275 mm A380 ALLOY (HEAD) GR15 BEARING STEEL (PUNCH)

YATO	L (mm)	
YT-5130	275	6/24



345 mm 65 Mn MATERIAL OF PUNCH PUNKTAK

YATO	L (mm)	
YT-5131	345	6/24

GB Spot weld cutter & drill bit set
 D Schweißpunktbohrer Set Schweißpunktfräser
 PL Zestaw rozwiertaków do zgrzewów punktowych
 RUS Набор для высверливания точечной сварки
 CZ Sada na odvrtání bodových svárů
 H Hegeztőpont maró készlet
 RO Set de freze pt. suduri în puncte
 F Jeu de fraises pour points de soudage
 I Set di alesatori per punti di saldatura
 E Juego de puntos de soldadura de la fresa
 CN 点焊刀

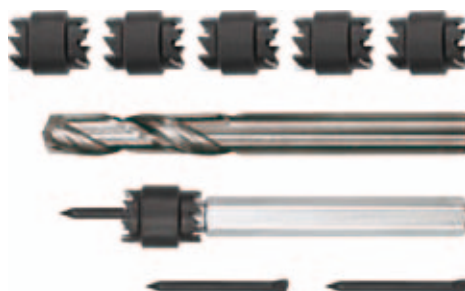

9 PCS 8 mm 10 mm HSS



YATO		
YT-28920		10/60

GB Combination edge setter / hole punch pliers
 D Kombinierte Absetzzange Lochzange
 PL Dziurkarko-felcarka
 RUS Дырокол, кромокгоиб
 CZ Falcovačka a děrovačka
 H Lyukasztó peremező fogó
 RO Cleste pt. fasonat si gaurit tabla

F Pince spéciale perforatrice carrosserie
 I Combinazione: bordo setter / pinza perforare
 E Solapadora y ponchadora manual
 CN 点焊刀

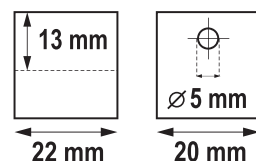

YATO		
YT-21582		10



GB Adjustable angle welding magnet
D Verstellbarer Magnet-Werkstückhalter
PL Wspornik magnetyczny spawalniczy regulowany
RUS Регулируемый магнит заварки угла
CZ Polohovací magnetický držák ke svařování
H Állítható, mágneses, hegesztő támasz
RO Dispozitiv magnetic reglabil pt. sudura
F Support magnétique de soudure
I Supporto della saldatura magnetico
E Soporte magnético de soldadura, ajustable
CN 焊接磁铁



DOUBLE
BLISTER



YATO	(kg)	mm	
YT-0862	2x22.5	85x65x22	6

GB Magnetic welding holder
D Magnet-Werkstückhalter
PL Kątownik magnetyczny spawalniczy
RUS Магнитная струбцина заварки

CZ Magnetický uhelník ke svařování
H Mágneses, hegesztő szögvas
RO Dispozitiv magnetic fixare pt. sudura
F Support magnétique de soudure

I Angolo magnetico da saldatura
E Escuadra magnética de soldadura
CN 焊接磁铁

DOUBLE
BLISTER



YATO	(kg)	mm	
YT-0863	11.5	82x120x13	6/48

YATO	(kg)	∅ (mm)	mm	
YT-0864	22.5	18	102x155x17	6/30
YT-0865	34.0	46	122x190x25	6/18

GB Magnetic welding holder
D Magnet-Werkstückhalter
PL Kątownik magnetyczny spawalniczy
RUS Магнитная струбцина заварки

CZ Magnetický uhelník ke svařování
H Mágneses, hegesztő szögvas
RO Dispozitiv magnetic fixare pt. sudura
F Support magnétique de soudure

I Triangolo magnetico da saldatura
con interruttore
E Escuadra magnética de soldadura
con interruptor
CN 焊接磁铁

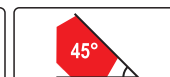

DOUBLE
BLISTER



YATO	(kg)	mm	
YT-0866	11.5	64x95x14	6/24
YT-0867	34.0	111x136x24	6/18

GB Magnetic welding holder with switch
D Magnet-Werkstückhalter mit Schalter
PL Kątownik magnetyczny spawalniczy
z wyłącznikiem
RUS Магнитный держатель заварки
с выключателем

CZ Magnetický uhelník ke svařování s vypínačem
H Mágneses, hegesztő szögvas, kapcsolóval
RO Dispozitiv magnetic fixare pt. sudura
cu intreruptor
F Support magnétique de soudure

I Triangolo magnetico da saldatura
con interruttore
E Escuadra magnética de soldadura,
con interruptor
CN 焊接磁铁

DOUBLE
BLISTER



YATO	(kg)	mm	
YT-0870	13.5	107x160x26	6/24

GB Tin snips
D Blechscherer
PL Nożyce do cięcia blachy

RUS Ножницы по металлу
CZ Nůžky na plech
H Lemezvágó olló

RO Foarfece pt. tablă
F Cisaille à tôle
I Cesioie per lamiere

E Tijeras para chapas
CN 铁皮剪

SLIDING CARD



LEFT CUT
CIECIE LEWE

CrMo

INCREASED CUTTING POWER
ZWIĘKSZONA SIŁA CIECIA

HRC 60-62

DIN 6438



HRC 60-62

DIN 6438



YATO	L (mm)	cutting length (mm)	cutting capacities (mm)				6/36
			copper	cold-rolled steel	hard steel HRC35	stainless steel 304	
YT-1910	260	35	1.80	1.50	1.00	0.90	6/36

YATO	L (mm)	cutting length (mm)	cutting capacities (mm)				6/36
			copper	cold-rolled steel	hard steel HRC35	stainless steel 304	
YT-1915	235	30	1.50	1.20	1.00	0.70	6/36

HRC 60-62

DIN 6438



HRC 56-62

SERRATED EDGES
ZABKOWANA KRAWĘDZ OSTRZY

HIGH FREQUENCY HARDENING
HARTOWANIE IMPULSOWE



YATO	L (mm)	cutting length (mm)	cutting capacities (mm)				6/36
			copper	cold-rolled steel	hard steel HRC35	stainless steel 304	
YT-1918	260	32	1.80	1.50	1.00	0.90	6/36

YATO	L (mm)	cutting length (mm)	cutting capacities (mm)				6/36
			copper	cold-rolled steel	hard steel HRC35	stainless steel 304	
YT-1960	250	40	2.00	1.50	1.00	0.80	6/36

GB Tin snips
D Blechscherer
PL Nożyce do cięcia blachy
RUS Ножницы по металлу
CZ Nůžky na plech
H Lemezvágó olló
RO Foarfece pt. tablă
F Cisaille à tôle
I Cesioie per lamiere
E Tijeras para chapas
CN 铁皮剪



LEFT CUT
CIECIE LEWE

HRC 60-62

90°

SERRATED EDGES
ZABKOWANA KRAWĘDZ OSTRZY



SLIDING CARD



YATO	L (mm)	cutting length (mm)	cutting capacities (mm)				6/36
			copper	cold-rolled steel	hard steel HRC35	stainless steel 304	
YT-1913	225	30	0.78	0.53	0.46	0.36	6/36

GB Tin snips
D Blechscherer
PL Nożyce do cięcia blachy

RUS Ножницы по металлу
CZ Nůžky na plech
H Lemezvágó olló

RO Foarfece pt. tablă
F Cisaille à tôle
I Cesioie per lamiere

E Tijeras para chapas
CN 铁皮剪

SLIDING CARD



STRAIGHT CUT
CIECIE PROSTE

CrMo

INCREASED CUTTING POWER
ZWIĘKSZONA SIŁA CIECIA

HRC 60-62

DIN 6438



HRC 60-62

DIN 6438



YATO	L (mm)	cutting length (mm)	cutting capacities (mm)				6/36
			copper	cold-rolled steel	hard steel HRC35	stainless steel 304	
YT-1912	260	35	1.80	1.50	1.00	0.90	6/36

YATO	L (mm)	cutting length (mm)	cutting capacities (mm)				6/36
			copper	cold-rolled steel	hard steel HRC35	stainless steel 304	
YT-1922	290	75	1.10	0.94	0.70	0.53	6/36

HRC 60-62

DIN 6438



HRC 56-62

SERRATED EDGES
ZABKOWANA KRAWĘDZ OSTRZY

HIGH FREQUENCY HARDENING
HARTOWANIE IMPULSOWE



YATO	L (mm)	cutting length (mm)	cutting capacities (mm)				6/36
			copper	cold-rolled steel	hard steel HRC35	stainless steel 304	
YT-1923	230	25	2.00	1.60	1.20	1.20	6/36

YATO	L (mm)	cutting length (mm)	cutting capacities (mm)				6/36
			copper	cold-rolled steel	hard steel HRC35	stainless steel 304	
YT-1962	250	45	2.00	1.50	1.00	0.80	6/36

GB Tin snips
D Blechscherer
PL Nożyce do cięcia blachy

RUS Ножницы по металлу
CZ Nůžky na plech
H Lemezvágó olló

RO Foarfece pt. tablă
F Cisaille à tôle
I Cesioie per lamiere

E Tijeras para chapas
CN 铁皮剪

SLIDING
CARD



RIGHT
CUT
CIECIE
PRAWIE

CrMo

INCREASED
CUTTING
POWER
ZWIĘKSZONA
SIŁA CIĘCIA

HRC
60-62

DIN
6438



HRC
60-62

DIN
6438



YATO	L (mm)	cutting length (mm)	cutting capacities (mm)				6/36
			copper	cold-rolled steel	hard steel HRC35	stainless steel 304	
YT-1911	260	35	1.80	1.50	1.00	0.90	6/36

YATO	L (mm)	cutting length (mm)	cutting capacities (mm)				6/36
			copper	cold-rolled steel	hard steel HRC35	stainless steel 304	
YT-1916	235	30	1.50	1.20	1.00	0.70	6/36

HRC
60-62

DIN
6438



HRC
56-62

SERRATED
EDGES
ZĄBKOWANA
KRAWĘDZ
OSTRY

HIGH
FREQUENCY
HARDENING
HARTOWANIE
IMPULSOWE



YATO	L (mm)	cutting length (mm)	cutting capacities (mm)				6/36
			copper	cold-rolled steel	hard steel HRC35	stainless steel 304	
YT-1919	260	32	1.80	1.50	1.00	0.90	6/36

YATO	L (mm)	cutting length (mm)	cutting capacities (mm)				6/36
			copper	cold-rolled steel	hard steel HRC35	stainless steel 304	
YT-1961	250	40	2.00	1.50	1.00	0.80	6/36

GB Tin snips
D Blechscherer
PL Nożyce do cięcia blachy
RUS Ножницы по металлу
CZ Nůžky na plech
H Lemezvágó olló
RO Foarfece pt. tablă
F Cisaille à tôle
I Cesioie per lamiere
E Tijeras para chapas
CN 铁皮剪



RIGHT
CUT
CIECIE
PRAWIE

HRC
60-62

CrMo

90°

SERRATED
EDGES
ZĄBKOWANA
KRAWĘDZ
OSTRY

SLIDING
CARD



YATO	L (mm)	cutting length (mm)	cutting capacities (mm)				6/36
			copper	cold-rolled steel	hard steel HRC35	stainless steel 304	
YT-1914	225	30	0.78	0.53	0.46	0.36	6/36

GB Tin snips
D Blechscherer
PL Nożyce do cięcia blachy
RUS Ножницы по металлу
CZ Nůžky na plech
H Lemezvágó olló
RO Foarfece pt. tablă
F Cisaille à tôle
I Cesioie per lamiere
E Tijeras para chapas
CN 铁皮剪



LEFT
CUT
CIECIE
LEWIE

DROP
FORGED
KUTE

HRC
58-61

SLIDING
CARD



YATO	L (mm)	cutting length (mm)	cutting capacities (mm)				6/24
			copper	cold-rolled steel	hard steel HRC35	stainless steel 304	
YT-1900	260	30	0.94	0.78	0.60	0.45	6/24

GB Tin snips
D Blechscherer
PL Nożyce do cięcia blachy
RUS Ножницы по металлу
CZ Nůžky na plech
H Lemezvágó olló

RO Foarfece pt. tablă
F Cisaille à tôle
I Cesioie per lamiere
E Tijeras para chapas
CN 铁皮剪

SLIDING
CARD



RIGHT
CUT
CIECIE
PRAWIE

DROP
FORGED
KUTE

HRC
58-61



YATO	L (mm)	cutting length (mm)	cutting capacities (mm)				6/24
			copper	cold-rolled steel	hard steel HRC35	stainless steel 304	
YT-1901	260	30	0.94	0.78	0.60	0.45	6/24

YATO	L (mm)	cutting length (mm)	cutting capacities (mm)				6/24
			copper	cold-rolled steel	hard steel HRC35	stainless steel 304	
YT-1902	300	50	0.94	0.78	0.60	0.45	6/24

GB Tin snips
D Blechscherer
PL Nożyce do cięcia blachy
RUS Ножницы по металлу

CZ Nůžky na plech
H Lemezvágó olló
RO Foarfece pt. tablă
F Cisaille à tôle

I Cesioie per lamiere
E Tijeras para chapas
CN 铁皮剪

SLIDING CARD



For cutting straight and tight curves left or right

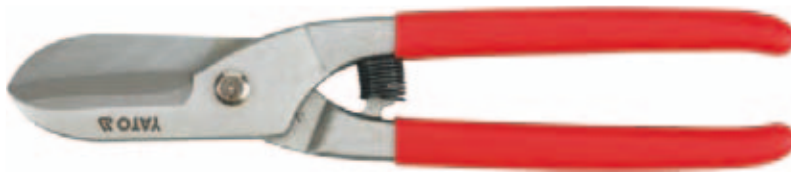

HRC 58-61

YATO	L (mm)	cutting length (mm)	cutting capacities (mm)				6/36
			copper	cold-rolled steel	hard steel HRC35	stainless steel 304	
YT-1924	254	52	0.94	0.78	0.60	0.45	6/36



STRAIGHT CUT
CIĘCIE PROSTE
HRC 58-61
DROP FORGED
KUTE

YATO	L (mm)	cutting length (mm)	cutting capacities (mm)				6/36
			copper	cold-rolled steel	hard steel HRC35	stainless steel 304	
YT-1925	225	52	0.94	0.78	0.60	0.45	6/36

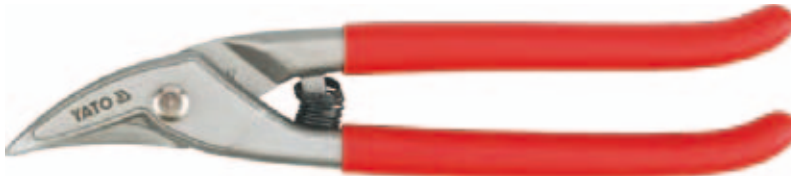

HRC 58-60

YATO	L (mm)	cutting length (mm)	cutting capacities (mm)				6/36
			copper	cold-rolled steel	hard steel HRC35	stainless steel 304	
YT-1920	260	42	1.20	1.00	0.60	0.50	6/36

GB Tin snips
D Blechscherer
PL Nożyce do cięcia blachy
RUS Ножницы по металлу
CZ Nůžky na plech
H Lemezvágó olló
RO Foarfece pt. tablă
F Cisaille à tôle
I Cesioie per lamiere
E Tijeras para chapas
CN 铁皮剪

SLIDING CARD



S55C
DROP FORGED
STEEL
STAL KUTA
NA ZIMNO

HRC 55-60

HIGH
FREQUENCY
HARDENING
HARTOWANIE
IMPULSOWE

GB Tin snips
D Blechscherer
PL Nożyce do cięcia blachy
RUS Ножницы по металлу
CZ Nůžky na plech
H Lemezvágó olló
RO Foarfece pt. tablă
F Cisaille à tôle
I Cesioie per lamiere
E Tijeras para chapas
CN 铁皮剪

SLIDING CARD



S55C
DROP FORGED
STEEL
STAL KUTA
NA ZIMNO

HRC 55-60

HIGH
FREQUENCY
HARDENING
HARTOWANIE
IMPULSOWE



YATO	L (mm)	cutting length (mm)	cutting capacities (mm)				6/36
			copper	cold-rolled steel	hard steel HRC35	stainless steel 304	
YT-1963	200	40	1.5	1.0	0.6	0.6	6/36
YT-1964	250	60	1.8	1.2	0.8	0.8	6/24
YT-1965	300	75	2.0	1.4	0.8	0.8	6/12



YATO	L (mm)	cutting length (mm)	cutting capacities (mm)				6/36
			copper	cold-rolled steel	hard steel HRC35	stainless steel 304	
YT-1970	260	42	2.0	1.4	1.0	1.0	6/36

- GB Steel strap cutter
D Stahlgurtblechscherer
PL Nożyce do cięcia taśmy stalowej
RUS Ножницы для резки стальной ленты
CZ Nůžky na plech
H Lemezvágó olló
RO Foarfece pt. tablă
F Cisaille à bande acier
I Cesoia per taglio reggetta in acciaio
E Tijeras para bandejas de acero
CN 钢带剪

HRC
58-61

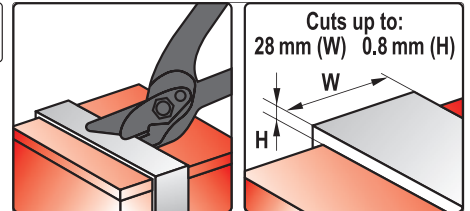

Cuts up to:
28 mm (W) 0.8 mm (H)



SLIDING
CARD

YATO	L (mm)	cutting length (mm)	cutting capacities (mm)				6/24
			copper	cold-rolled steel	hard steel HRC35	stainless steel 304	
YT-1930	305	28	-	1.00	0.80	0.60	

- GB Portable notchers
D Schere zum Ausschneiden von Ecken
PL Nożyce do wycinania naroży
RUS Ножницы для наружных углов
CZ Nůžky na vystřihování rohů
H Sarokkivágó olló
- RO Foarfece pt. taierea colturilor
F Ciseaux pour le coupage des coins
I Cesoie per taglio reggetta in angoli
E Tijera para esquinas
CN 截角器

300
mm 90°

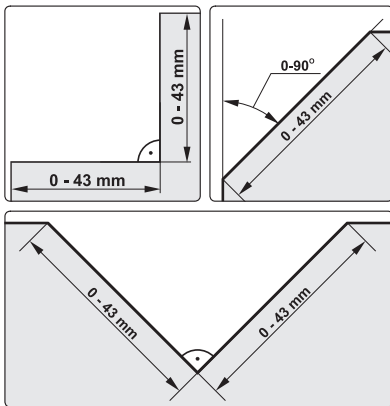

COLOR
BOX

YATO	L (mm)	15
YT-1939	300	

- GB Straight pliers
D Zange zum Blechbiegen
PL Kleszcze do gięcia blach
RUS Клещи с тупым ножом для жести
CZ Kleště na ohýbání plechu
H Falcfogó
RO Cleste pt. indoirea tablei
- F Pince à fléchir la tôle
I Taglie per la lamiera
E Tenazas para
doblar hojalata
CN 钣金钳

COLOR
BOX



45° 55 mm

90° 55 mm



180° 55 mm

YATO	L (mm)	10/20	YATO	L (mm)	10/20	YATO	L (mm)	10/20
YT-5416	280		YT-5417	260		YT-5415	280	

18

**Power & gasoline tools
Elektronarzędzia
i narzędzia spalinowe**



Cordless tools Narzędzia akumulatorowe 408-411 	Hot air guns Opalarki 422-423 
Angle grinders Szlifierki kątowe 412 	Burners & soldering tools Palniki i lutownice 423-425 
Car polishers Polerki samochodowe 413 	Glue guns Pistolety do klejenia 425 
Cut-off machines Przecinarki do metalu 413 	Pipe welders Zgrzewarki do rur 425 
Drilling machines Wiertarki 414-415 	Generators Generatory 426-427 
Drywall screwdrivers Wkrętarki do regipsów 415 	Pumps Pompy 427-428 
Rotary hammers Młotowiertarki 415-416 	Cordless garden tools & accessories Ogrodowe narzędzia akumulatorowe i akcesoria 429-430 
Circular saws Pilarki tarczowe 417 	Cordless chainsaws Akumulatorowe pilarki łańcuchowe..... 429 Cordless grass trimmers Akumulatorowe wykasarki..... 430 Cordless hedge trimmers Akumulatorowe nożyce do żywopłotu..... 430
Miter saws Ukośnice 417-418 	Electric garden tools Ogrodowe narzędzia elektryczne 431 
Jig saws Wyrzynarki 418-419 	Electric chainsaws Elektryczne pilarki łańcuchowe..... 431
Planers Strugi 419 	Gasoline garden tools & accessories Ogrodowe narzędzia spalinowe i akcesoria 431-438 
Sabre saws Piły szablaste 419 	Gasoline sprayers Opryskiwacze spalinowe..... 431 Gasoline chainsaws Pilarki spalinowe..... 432 Gasoline brushcutters Kosy spalinowe..... 433 Gasoline hedge trimmers Spalinowe nożyce do żywopłotu..... 433 Accessories Akcesoria..... 434
Finishing sanders Szlifierki oscylacyjne 419 	Electric hoists Elektryczne wciągarki linowe 438 
Multi-purpose oscillating tools Wielofunkcyjne narzędzia oscylacyjne 420-421 	
Knives Noże 422 	

GB Cordless drill / driver
 D Akkuschauber- und -bohrer
 PL Wiertarko-wkrętarła akumulatorowa
 RUS Аккумуляторная дрель с шурупвертом
 CZ Akumulátorový vrtací sroubovák
 H Akkumulátoros fúró-csavarhúzó
 RO Bormasina-surubelnita cu acumulator
 F Perceuse rechargeable
 I Trapano avvitatore a batteria
 E Taladro-desarmador con acumulador
 CN 充电式电钻



10.8 V	Li-Ion	1h QUICK CHARGING SYSTEM SZYBKA ŁADOWANIE	0-350 min ² 0-1300 min ¹
24 Nm	↻	⚡	10 mm



additional battery in set
 dodatkowy akumulator w zestawie

BMC & COLOR SLEEVE

YATO	V	
YT-82851	10.8	5

GB Cordless drill / driver
 D Akkuschauber- und -bohrer
 PL Wiertarko-wkrętarła akumulatorowa
 RUS Аккумуляторная дрель с шурупвертом
 CZ Akumulátorový vrtací sroubovák
 H Akkumulátoros fúró-csavarhúzó
 RO Bormasina-surubelnita cu acumulator
 F Perceuse rechargeable
 I Trapano avvitatore a batteria
 E Taladro-desarmador con acumulador
 CN 充电式电钻



14.4 V	Li-Ion	1h QUICK CHARGING SYSTEM SZYBKA ŁADOWANIE	0-350 min ² 0-1200 min ¹
36 Nm	↻	⚡	10 mm

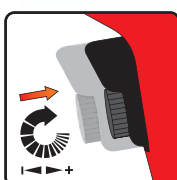

additional battery in set
 dodatkowy akumulator w zestawie

BMC & COLOR SLEEVE

YATO	V	
YT-82853	14.4	3

GB Cordless drill / driver
 D Akkuschauber- und -bohrer
 PL Wiertarko-wkrętarła akumulatorowa
 RUS Аккумуляторная дрель с шурупвертом
 CZ Akumulátorový vrtací sroubovák
 H Akkumulátoros fúró-csavarhúzó
 RO Bormasina-surubelnita cu acumulator
 F Perceuse rechargeable
 I Trapano avvitatore a batteria
 E Taladro-desarmador con acumulador
 CN 充电式电钻



18 V	Li-Ion	1h QUICK CHARGING SYSTEM SZYBKA ŁADOWANIE	0-350 min ² 0-1200 min ¹
42 Nm	↻	⚡	10 mm

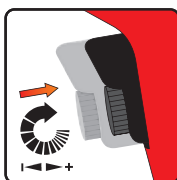

additional battery in set
 dodatkowy akumulator w zestawie

BMC & COLOR SLEEVE

YATO	V	
YT-82855	18	3

GB Battery
D Akkumulator
PL Akumulator
RUS Аккумулятор
CZ Akumulátor
H Akumulátor
RO Acumulatorul
F Batterie
I Batteria
E Bateria
CN 锂电池



10.8 V  1h  1500 mAh



WHITE CARTON BOX & COLOR LABEL



for / dla: YT-82850, YT-82900

YATO 	V	
YT-82857	10.8	40

GB Battery
D Akkumulator
PL Akumulator
RUS Аккумулятор
CZ Akumulátor
H Akumulátor
RO Acumulatorul
F Batterie
I Batteria
E Bateria
CN 锂电池



14.4 V  1h  1500 mAh



WHITE CARTON BOX & COLOR LABEL



for / dla: YT-82853, YT-82855

YATO 	V	
YT-82858	14.4	20
YT-82859	18	20

GB Battery charger
D Ladegerät
PL Ładowarka
RUS Зарядное устройство
CZ Nabíječka
H Akkutöltő
RO Redresor
F Chargeur de batterie
I Caricabatteria
E Rectificador
CN 充电器



230V~ 50Hz   1h  



WHITE CARTON BOX & COLOR LABEL



for / dla: YT-82851, YT-82857, YT-82900

YATO 	V	
YT-82861	10.8	8

GB Battery charger
D Ladegerät
PL Ładowarka
RUS Зарядное устройство
CZ Nabíječka
H Akkutöltő
RO Redresor
F Chargeur de batterie
I Caricabatteria
E Rectificador
CN 充电器



230V~ 50Hz    1h  



WHITE CARTON BOX & COLOR LABEL



for / dla: YT-82853, YT-82858,
YT-82855, YT-82859

YATO 	V	
YT-82862	14.4	8
YT-82863	18	8

GB Cordless impact wrench
 D Akku-schlagschrauber
 PL Akumulatorowy klucz udarowy
 RUS Аккумуляторный ударный гайковерт
 CZ Akumulátorový rázový utahovák
 H Aakkus ütvecsavarozó
 RO Pistol impact cu acumulator
 F Clé a choc sans fil
 I Chiave ad impulsi con chiavi a bussola esagonale
 E Inalámbrico llave de impacto
 CN 气动棘轮扳手

1/2" 12.5mm	280 Nm	18 V	0-2200 min	T 0-3300 mm
Li-Ion	3000 mAh	2h QUICK CHARGING SZYBKE ŁADOWANIE	LED BATTERY INDICATOR WYŚWIETLACZNIKI WYKAZUJĄCE POZIOMY KIERUNKOWANIE	17,19 21,22 mm

GB Cordless impact wrench
 D Akku-schlagschrauber
 PL Akumulatorowy klucz udarowy
 RUS Аккумуляторный ударный гайковерт
 CZ Akumulátorový rázový utahovák
 H Aakkus ütvecsavarozó
 RO Pistol impact cu acumulator
 F Clé a choc sans fil
 I Chiave ad impulsi con chiavi a bussola esagonale
 E Inalámbrico llave de impacto
 CN 气动棘轮扳手

1/2" 12.5mm	280 Nm	18 V	0-2200 min	T 0-3300 mm
Li-Ion	3000 mAh	2h QUICK CHARGING SZYBKE ŁADOWANIE	LED BATTERY INDICATOR WYŚWIETLACZNIKI WYKAZUJĄCE POZIOMY KIERUNKOWANIE	17,19 21,22 mm

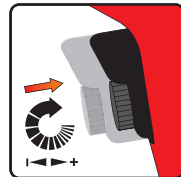

BMC
& COLOR SLEEVE

BMC
& COLOR SLEEVE

additional battery in set
 dodatkowy akumulator
 w zestawie

YATO	Nm	Box
YT-82930	280	3

YATO	Nm	Box
YT-82931	280	3

18

GB Battery
 D Akkumulator
 PL Akumulator
 RUS Аккумулятор
 CZ Akumulátor
 H Akumulátor
 RO Acumulatorul
 F Batterie
 I Batteria
 E Bateria
 CN 锂电池



WHITE CARTON BOX
& COLOR LABEL



18 V	Li-Ion	3000 mAh	2h QUICK CHARGING SZYBKE ŁADOWANIE
---------	--------	-------------	--

for / dla: YT-82930, YT-82931

YATO	V	Box
YT-82932	18	20

- GB Multi-purpose oscillating tool
- D Multifunktionales Oszillationswerkzeug
- PL Wielofunkcyjne narzędzie oscylacyjne
- RUS Многофункциональный инструмент
- CZ Multifunkční oscilační nářadí
- H Multifunkciós rezgő szerszám
- RO Unealtă multifuncțională oscilantă
- F Outil multifonctions oscillant
- I Oscillante strumento multifunzione
- E Herramienta oscilatoria multusos
- CN 多功能啊雄莓

BMC
& COLOR SLEEVE



10.8
V

Li-Ion



1h
QUICK CHARGING
SZYBKIE ŁADOWANIE

5000-15000
min!

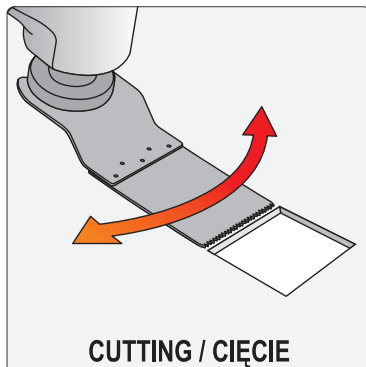
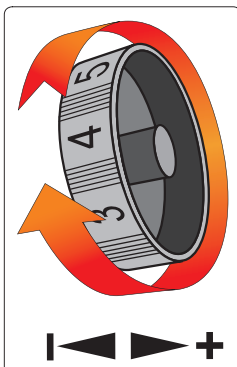
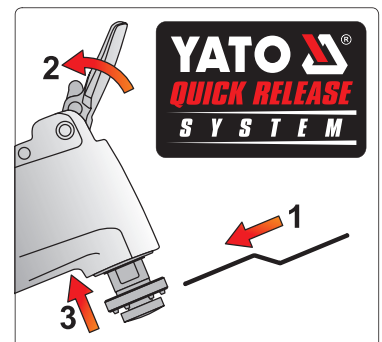
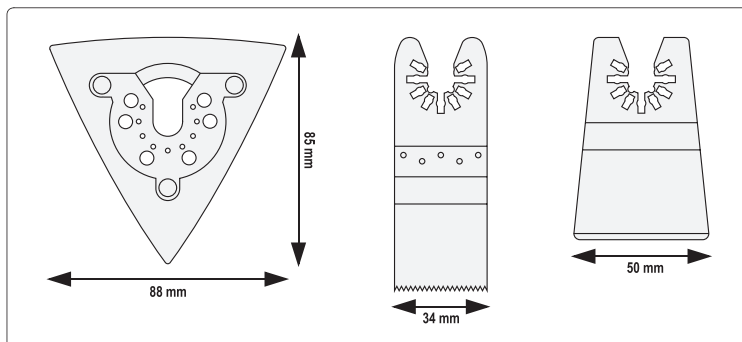

additional battery in set
dodatkowy akumulator
w zestawie



YATO 	V	
YT-82900	10.8	5



- GB Angle grinder
- D Winkelschleifmaschine
- PL Szlifierka kątowa
- RUS Угловой шлифовальный станок
- CZ Úhlová bruska
- H Sarokcsiszológ
- RO Polizor unghiular
- F Meuleuse d'angle
- I Smelgiatrice angolare
- E Lijadera de angulo
- CN 角向磨光机



230V~50Hz	750 W
11500 min ⁻¹	115 mm
M14	



COLOR BOX

YATO 	W	
YT-82091	720	8



- GB Angle grinder
- D Winkelschleifmaschine
- PL Szlifierka kątowa
- RUS Угловой шлифовальный станок
- CZ Úhlová bruska
- H Sarokcsiszológ
- RO Polizor unghiular
- F Meuleuse d'angle
- I Smelgiatrice angolare
- E Lijadera de angulo
- CN 角向磨光机



230V~50Hz	850 W
11000 min ⁻¹	125 mm
M14	



COLOR BOX

YATO 	W	
YT-82094	850	10



- GB Angle grinder
- D Winkelschleifmaschine
- PL Szlifierka kątowa
- RUS Угловой шлифовальный станок
- CZ Úhlová bruska
- H Sarokcsiszológ
- RO Polizor unghiular
- F Meuleuse d'angle
- I Smelgiatrice angolare
- E Lijadera de angulo
- CN 角向磨光机



230V~50Hz	1100 W
11000 min ⁻¹	125 mm
M14	



COLOR BOX

YATO 	W	
YT-82100	1100	6



- GB Angle grinder
- D Winkelschleifmaschine
- PL Szlifierka kątowa
- RUS Угловой шлифовальный станок
- CZ Úhlová bruska
- H Sarokcsiszológ
- RO Polizor unghiular
- F Meuleuse d'angle
- I Smelgiatrice angolare
- E Lijadera de angulo
- CN 角向磨光机



230V~50Hz	2100 W
6500 min ⁻¹	230 mm
DUST PROOF MOTOR ZABEZPIECZENIE PRZECIWPYLEWIE	M14
	



COLOR BOX

YATO 	W	
YT-82103	2100	2

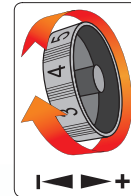

- GB Car polisher
- D Autopoliermaschine
- PL Polerka samochodowa
- RUS Полировальная машина
- CZ Leštička na automobily
- H Gépkocsi polírozógép
- RO Masina de lustruit automobile
- F Polisseur de voiture
- I Levigatrice rotoorbitale
- E Maquina para pulir coches
- CN 抛光机



230V~ 50Hz	1200 W
1000-3000 mm ²	180 mm
M16	5 m
	



BMC
& COLOR SLEEVE



YATO 	W	
YT-82195	1200	3

- GB Grinding wheel cutter for metal
- D Trennschleifer für Metall
- PL Przecinarka ściernicowa do metalu
- RUS Абразивно-отрезной станок по металлу
- CZ Rozbrušovací pila na kovy
- H Gyorsdaraboló fémhez
- RO Ferăstrău abraziv pt. metal
- F Scie a métaux
- I Macchina da taglio
- E Cortador abrasivo para metales
- CN 型材切割机

230V~ 50Hz	2300 W
0-3800 mm ²	355x25.4
CUTTING CIĘCIE 0-90°	LONG LIFE MOTOR TRWAŁY SILNIK
	





COLOR
BOX

YATO 	W	
YT-82180	2300	1

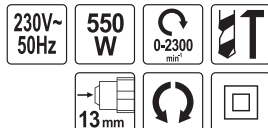
GB Impact drill
 D Schlagbohrmaschine
 PL Wiertarka udarowa
 RUS Ударная дрель
 CZ Nárazová vrtačka
 H Kezelési utasítás
 RO Masina de gaurit
 F Perceuse à percussion
 I Trapano a percussione
 E Taladradora de percusión
 CN 冲击钻





COLOR BOX

YATO 	W	
YT-82030	550	5

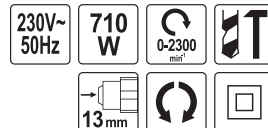
GB Impact drill
 D Schlagbohrmaschine
 PL Wiertarka udarowa
 RUS Ударная дрель
 CZ Nárazová vrtačka
 H Kezelési utasítás
 RO Masina de gaurit
 F Perceuse à percussion
 I Trapano a percussione
 E Taladradora de percusión
 CN 冲击钻





COLOR BOX

YATO 	W	
YT-82035	710	5

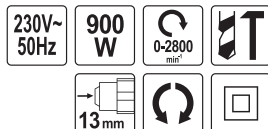
GB Impact drill
 D Schlagbohrmaschine
 PL Wiertarka udarowa
 RUS Ударная дрель
 CZ Nárazová vrtačka
 H Kezelési utasítás
 RO Masina de gaurit
 F Perceuse à percussion
 I Trapano a percussione
 E Taladradora de percusión
 CN 冲击钻





COLOR BOX

YATO 	W	
YT-82040	900	5

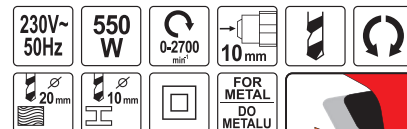
GB Electric drill
 D Elektrobohrmaschine
 PL Wiertarka elektryczna
 RUS Электрическая дрель
 CZ Elektrická vrtačka
 H Elektromos fűrógép
 RO Mașină de găurit electrică
 F Perceuse à métal
 I Trapano
 E Taladro eléctrico
 CN 电钻



COLOR BOX

YATO 	W	
YT-82050	550	5

GB Electric drill
D Elektrobohrmaschine
PL Wiertarka elektryczna
RUS Электрическая дрель
CZ Elektrická vrtačka
H Elektromos fűrógép
RO Mașină de găurit electrică
F Perceuse à métal
I Trapano
E Taladro eléctrico
CN 电钻

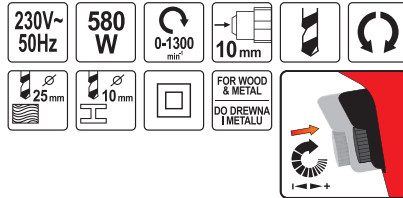

COLOR BOX

YATO	W	
YT-82051	580	5

GB Drywall screwdriver
D Trockenbauschrauber
PL Wkrętarka elektryczna
RUS Сетевой шуруповерт
CZ Sádokartonáfský šroubovák
H Gipszkarton csavarzó
RO Șurubelniță pt. gips-carton
F Perceuse aux plaques de plâtre
I Trapano
E Atornilladores para construcción en seco
CN 墙板螺丝刀

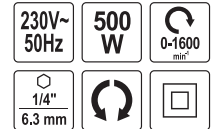

COLOR BOX

YATO	W	
YT-82070	500	5

GB Rotary hammer
D Bohrhammer
PL Młotowiertarka SDS-plus
RUS Перфоратор
CZ Vrtací kladivo
H Fűrókalapács
RO Ciocan rotopercutor
F Marteau perforateur
I Martello rotativo
E Martillo perforador
CN 电锤

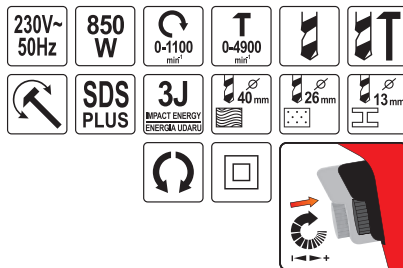

BMC & COLOR SLEEVE

YATO	W	
YT-82120	850	4

GB Rotary hammer
D Bohrhammer
PL Młotowiertarka SDS-plus
RUS Перфоратор
CZ Vrtací kladivo
H Fűrókalapács
RO Ciocan rotopercutor
F Marteau perforateur
I Martello rotativo
E Martillo perforador
CN 电锤

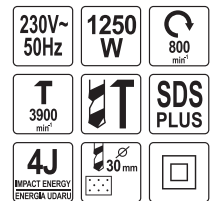





BMC & COLOR SLEEVE



YATO	W	
YT-82125	1250	2

- GB Rotary hammer
- D Bohrhämmer
- PL Miotowiertarka SDS-plus
- RUS Перфоратор
- CZ Vrtací kladivo
- H Fúrókalapács
- RO Ciocan rotopercutor
- F Marteau perforateur
- I Martello rotativo
- E Martillo perforador
- CN 电锤









230V~ 50Hz	1500 W	 800 min ⁻¹
 3900 min ⁻¹		SDS PLUS
5J IMPACT ENERGY ENERGIA UDARU	 32mm	





YATO 	W	
YT-82127	1500	2

- GB Rotary hammer
- D Bohrhämmer
- PL Miotowiertarka SDS-max
- RUS Перфоратор
- CZ Vrtací kladivo
- H Fúrókalapács
- RO Ciocan rotopercutor
- F Marteau perforateur
- I Martello rotativo
- E Martillo perforador
- CN 电锤









230V~ 50Hz	1050 W	 0-480 min ⁻¹	 0-3780 min ⁻¹
		 38mm	SDS MAX
9J IMPACT ENERGY ENERGIA UDARU			





YATO 	W	
YT-82130	1050	2

- GB Rotary hammer
- D Bohrhämmer
- PL Miotowiertarka SDS-max
- RUS Перфоратор
- CZ Vrtací kladivo
- H Fúrókalapács
- RO Ciocan rotopercutor
- F Marteau perforateur
- I Martello rotativo
- E Martillo perforador
- CN 电锤



230V~ 50Hz	1600 W	 175-350 min ⁻¹	 1150-2350 min ⁻¹
		 52mm	SDS MAX
25J IMPACT ENERGY ENERGIA UDARU			



YATO 	W	
YT-82135	1600	1

GB Circular saw
D Handkreissäge
PL Piłarka elektryczna
RUS Дисковая пила
CZ Ručná kružná píla
H Kézi körfűrész
RO Ferăstrău circular de mana
F Tronçonneuse
I Sega circolare
E Sierra circular
CN 电圆锯

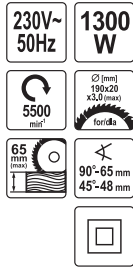

COLOR BOX

YATO	W	
YT-82150	1300	2

GB Circular saw
D Handkreissäge
PL Piłarka elektryczna
RUS Дисковая пила
CZ Ručná kružná píla
H Kézi körfűrész
RO Ferăstrău circular de mana
F Tronçonneuse
I Sega circolare
E Sierra circular
CN 电圆锯

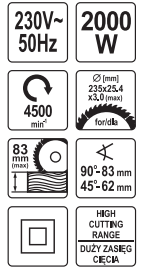

COLOR BOX

YATO	W	
YT-82153	2000	2

GB Mitre saw
D Paneelsäge
PL Ukośnica
RUS Панельная пила
CZ Pokosová píla se základzem
H Sínes gérvágó
RO Ferăstrău circular staționar
F Scie à onglet radiale
I Sega angolare taglio leghe
E Ingletadora telescópica
CN 斜切锯



COLOR BOX

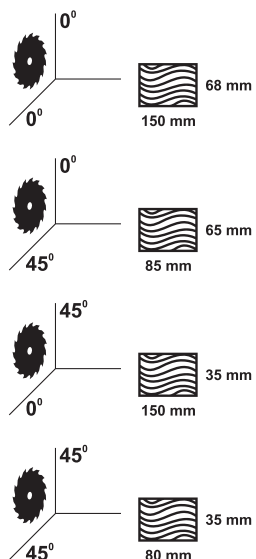

YATO	W	
YT-82170	1800	1

- GB Mitre saw
- D Paneelsäge
- PL Ukośnica
- RUS Панельная пила
- CZ Pokosová pila se zákluzem
- H Sines gérvágó
- RO Ferăstrău circular staționar
- F Scie à onglet radiale
- I Segha angolare taglio leghe
- E Ingletadora telescópica
- CN 斜切锯

230V~ 50Hz	1800 W	4800 mm ²
255x30x2,8 (mm)	60T	



COLOR BOX

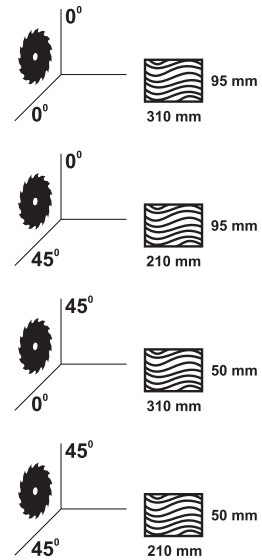

YATO	W	
YT-82171	1800	1

- GB Jig saw
- D Stichsäge
- PL Wyrzynarka
- RUS Электрический лобзик
- CZ Přímočará pila
- H Szűrőfűrész
- RO Ferăstrău pt. traforaj
- F Scie sauteuse
- I Seghetto alternativo
- E Sierra de calar
- CN 曲线锯

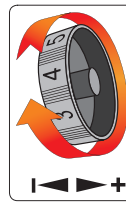

230V~ 50Hz	550 W
800-2600 mm ²	65 mm
6mm	

- GB Jig saw
- D Stichsäge
- PL Wyrzynarka
- RUS Электрический лобзик
- CZ Přímočará pila
- H Szűrőfűrész
- RO Ferăstrău pt. traforaj
- F Scie sauteuse
- I Seghetto alternativo
- E Sierra de calar
- CN 曲线锯

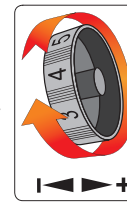

230V~ 50Hz	750 W
800-3000 mm ²	80 mm
6mm	



COLOR BOX

YATO	W	
YT-82270	550	5



COLOR BOX

YATO	W	
YT-82271	750	5

- GB Jig saw
- D Stichsäge
- PL Wyrzynarka
- RUS Электрический лобзик
- CZ Přímočará pila
- H Szúrófűrész
- RO Ferăstrău pt. traforaj
- F Scie sauteuse
- I Seghetto alternativo
- E Sierra de calar
- CN 曲线锯





QUICK REPLACEMENT **SZYBKĄ WYMIANĄ**

230V~50Hz **750 W**



800-2800 min⁻¹ 110 mm

10 mm 45°



COLOR BOX

YATO 	W	
YT-82272	750	5

- GB Electric planer
- D Elektrohobel
- PL Śruga elektryczny
- RUS Электрорубанок
- CZ Elektrický hoblík
- H Elektromos gyalu
- RO Rindea electrica
- F Rabot
- I Pialla elettrica
- E Garlopa electrica
- CN 电刨





230V~50Hz **1050 W**

16000 min⁻¹ 0-3 mm

82 mm 



COLOR BOX

YATO 	W	
YT-82140	1050	4

- GB Sabre saw
- D Stichsägee
- PL Pila szablasta
- RUS Сабельная пила
- CZ Šavlová pila
- H Szablyafűrész
- RO Ferăstrău electric
- F Scie sabre
- I Sega elettrica alternativa
- E Serra de sabre
- CN 往复锯



QUICK REPLACEMENT **SZYBKĄ WYMIANĄ**

230V~50Hz **1200 W**



800-2800 min⁻¹ 210 mm

10 mm 





COLOR BOX

YATO 	W	
YT-82280	1200	4

- GB Finishing sander
- D Schwingschleifer
- PL Szlifierka oscylacyjna
- RUS Виброшлифмашина
- CZ Oscilační bruska
- H Vibrációs csiszológép
- RO Polizor oscilant
- F Ponceuse vibrante
- I Levigatrici orbitali
- E Lijadora de oscilación
- CN 砂光机



230V~50Hz **260 W**



13000 min⁻¹ 

50mm x6

GRIT / ZIARNOŚĆ: 60, 80, 100, 120, 180, 240



COLOR BOX

YATO 	W	
YT-82230	260	4

- GB Multi-purpose oscillating tool
- D Multifunktionales Oszillationswerkzeug
- PL Wielofunkcyjne narzędzie oscylacyjne
- RUS Многофункциональный инструмент
- CZ Multifunkční oscilační nářadí
- H Multifunkciós rezgő szerszám
- RO Unealtă multifuncțională oscilantă
- F Outil multifonctions oscillant
- I Oscillante strumento multifunzione
- E Herramienta oscilatoria multiusos
- CN 多功能啊雄莓

BMC
& COLOR
SLEEVE



10.8
V

Li-Ion

1h
QUICK CHARGES
SYSTEM
LADUNGWARE

5000-15000
min



additional battery in set
dodatkowy akumulator
w zestawie

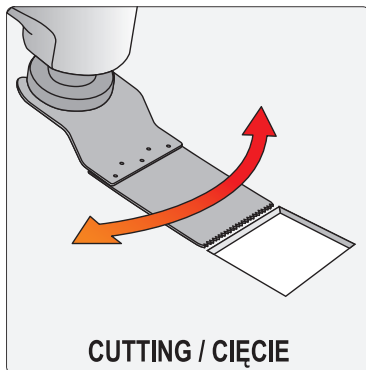
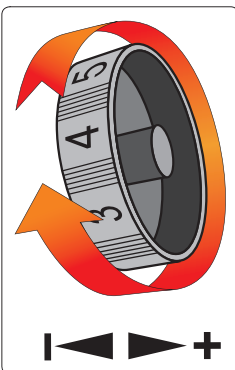
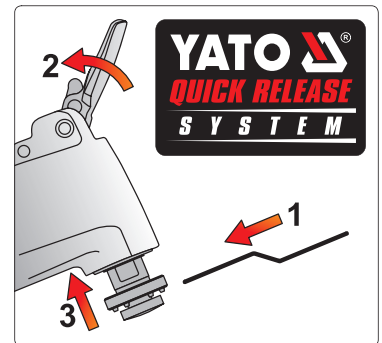
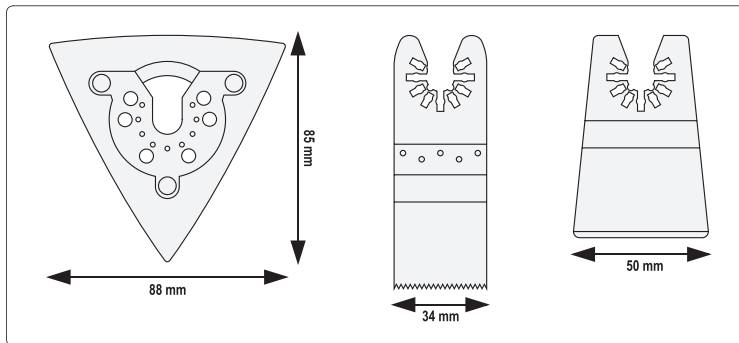

YATO	V	
YT-82900	10.8	5

- GB Multi-purpose oscillating tool
- D Multifunktionales Oszillationswerkzeug
- PL Wielofunkcyjne narzędzie oscylacyjne
- RUS Многофункциональный инструмент
- CZ Multifunkční oscilační nářadí
- H Multifunkciós rezgő szerszám
- RO Unealtă multifuncțională oscilantă
- F Outil multifonctions oscillant
- I Oscillante strumento multifunzione
- E Herramienta oscilatoria multiusos
- CN 多功能啊雄莓

BMC
& COLOR
SLEEVE



230V~ 50Hz	300 W
 15000-22000 mm ²	

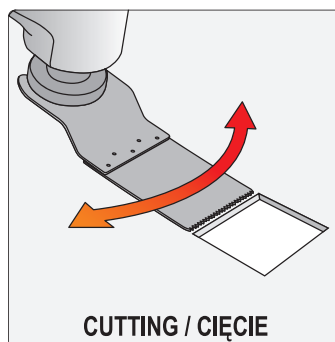
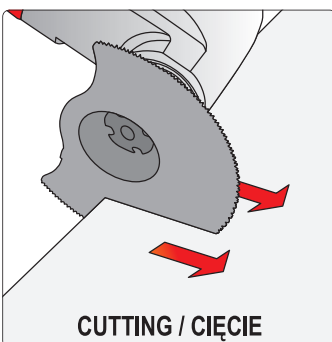
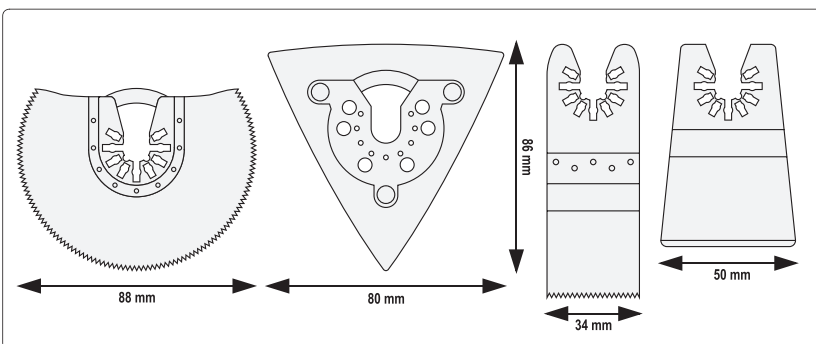
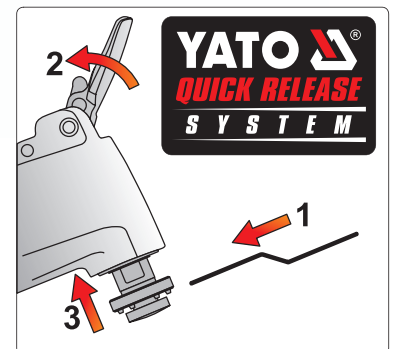

YATO 	W	
YT-82220	300	4

GB Thermal knife for polystyrene foam
 D Thermomesser für Styropor
 PL Nóż termiczny do styropianu
 RUS Термонож для пенопласта

CZ Termický nůž na pěnový polystyrén
 H Polisztirol vágó hőkés
 RO Cuițit termic pt. stiropian
 F Couteau thermique à styrofoam

I Coltello termico per polistirolo
 E Cuchilla térmica para poliestireno
 CN 热切割刀

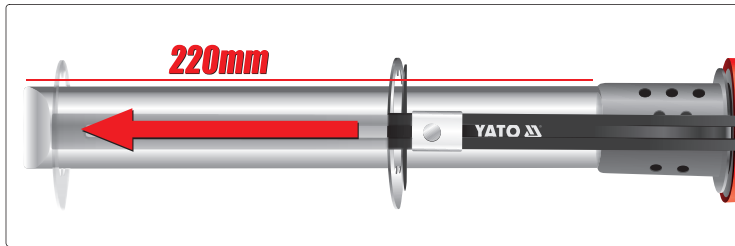
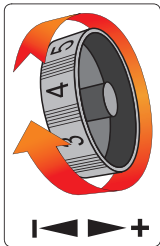
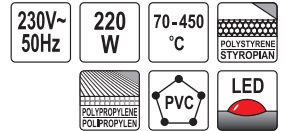

COLOR BOX



YATO	W	L (mm)	
YT-82190	220	220	10

GB Hot air gun
 D Heissluftpistole
 PL Opalarka
 RUS Фен для обжигания краски
 CZ Opalovací stroj
 H Hőlégfúvó
 RO Fion pt. ars vopseaua
 F Décapeur thermique
 I Generatore aria calda
 E Secadora
 CN 热风枪

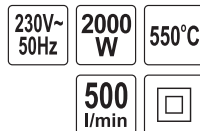

GB Hot air gun with accessories
 D Heissluftpistole
 PL Opalarka z akcesoriami
 RUS Фен для обжигания краски в наборе
 CZ Opalovací stroj s příslušenstvím
 H Hőlégfúvó tartozékokkal
 RO Fion cu accesorii pt. ars vopseaua
 F Décapeur thermique
 I Generatore aria calda con accessori
 E Secadora con accesorios
 CN 热风枪

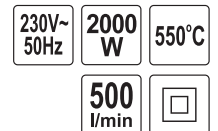

COLOR BOX

YATO	W	
YT-82288	2000	10



BMC & COLOR SLEEVE

YATO	W	
YT-82291	2000	5

- GB Hot air gun with accessories
D Heissluftpistole
PL Opalarka z akcesoriami
RUS Фен для обжигания краски в наборе
CZ Opalovací stroj s příslušenstvím
H Hőlégtűvő tartozékokkal
RO Fion cu accesorii pt. ars vopsea
F Décapeur thermique
I Generatore aria calda con accessori
E Secadora con accesorios
CN 热风枪

230V~50Hz 2000 W
550°C 500 l/min
LED

TEMPERATURE ADJUSTMENT



REGULACJA TEMPERATURY



YATO	W	
YT-82292	2000	5

- GB Hot air gun with accessories
D Heissluftpistole
PL Opalarka z akcesoriami
RUS Фен для обжигания краски в наборе
CZ Opalovací stroj s příslušenstvím
H Hőlégtűvő tartozékokkal
RO Fion cu accesorii pt. ars vopsea
F Décapeur thermique
I Generatore aria calda con accessori
E Secadora con accesorios
CN 热风枪

230V~50Hz 2000 W
600°C 500 l/min
LCD DISPLAY

TEMPERATURE ADJUSTMENT



REGULACJA TEMPERATURY



YATO	W	
YT-82293	2000	5

- GB Gas torch
D Gasbrenner
PL Palnik gazowy
RUS Газовая паяльная лампа
CZ Plynový hořák
H Gázégő
- RO Arzător de gaz
F Brûleur à gaz
I Saldatore bruciatore a gas
E Soplete de gas
CN 火焰枪

PIEZO 30 ml 60-90 min GAS GAZ

LOCK BLOKADA BUTANE lighter gas BUTAN (gaz do zapalniczy) CHILD PROTECTION ZABEZPECZENIE PRZED DZIECIAMI

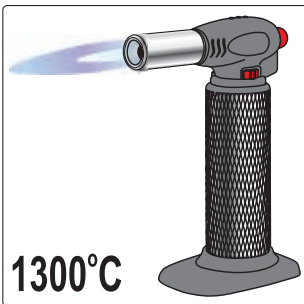

YATO		
YT-36700		10/20

- GB Soldering tool set
D Gaslötkolben satz
PL Lutownica gazowa z akcesoriami
RUS Газовый паяльный набор
CZ Plynova pajka souprava
H Gaz forrasztópaka készletek
RO Set ciocan de lipit cu gaz
F Fer à souder à gaz
I Saldatore a gas
E Soldador a gas con accesorios
CN 自动点火多功能瓦斯组套

SOLDERING IRON
LUTOWNICA 450°C

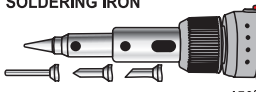

HOT AIR GUN
OPALARKA 600°C

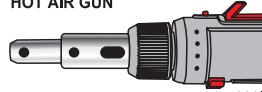

TORCH
PALNIK 1300°C

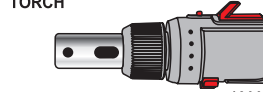

7 PCS 30-125 W
30 ml 75 min
GAS GAZ PIEZO
LOCK BLOKADA BUTANE lighter gas BUTAN (gaz do zapalniczy) CHILD PROTECTION ZABEZPECZENIE PRZED DZIECIAMI

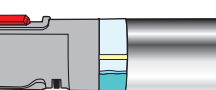
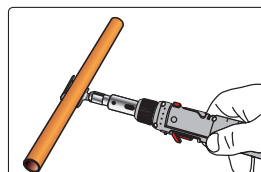
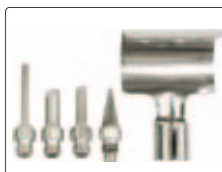

GAS LEVEL INSPECTION WINDOW KONTROLA POZIOMU GAZU

YATO	W	
YT-36706	30-125	6

PLASTIC BOX & HANGING COLOR BOX

- GB Soldering tool 3 in 1
- D Gaslötkolben 3 in 1
- PL Lutownica gazowa 3 w 1
- RUS Газовый паяльник 3-в-1
- CZ Plynová pájka 3 in 1
- H Gaz-forrasztópaka 3 in 1
- RO Ciocan de lipit cu gaz 3 in 1
- F Fer à souder à gaz
- I Saldatore a gas
- E Soldador de gas 3 in 1
- CN 瓦斯焊接工具



PIEZO	30~70 W	12 ml	60 min	GAS GAZ
LOCK BLOKADA	BUTANE lighter gas BUTAN gaz de zapalnică	PROPANE-BUTANE lighter gas PROPAN-BUTAN gaz de zapalnică	CHILD PROTECTION ZABEZPEČENIE PŘED DĚTMI	

SOLDERING IRON LUTOWNICA 350°C	HOT AIR GUN OPALARKA 550°C	TORCH PALNIK 1300°C	GAS LEVEL INSPECTION WINDOW KONTROLA POZIOMU GAZU
--	--------------------------------------	-------------------------------	---

SLIDING CARD

YATO	W	
YT-36704	30-70	12/72

- GB Gas blow torch
- CZ Plynový hořák
- I Saldatore bruciatore a gas
- D Lötbrenner
- H Gázégő
- E Soplete de gas
- PL Palnik gazowy
- RO Arzător de gaz
- CN 火焰枪
- RUS Газовая горелка
- F Bruleur à gaz

PIEZO	1.28 kW	GAS GAZ	AIR POWETRZE	LOCK BLOKADA	BUTANE BUTAN
-------	---------	---------	--------------	--------------	--------------



SLIDING CARD

YATO	kW	
YT-36709	1.28	6/12

- GB Soldering iron
- D Lötkolben
- PL Lutownica orogowa
- RUS Электропаяльник
- CZ Pájka odporová
- H Forrasztópáka
- RO Ciocan de lipit
- F Fer à souder
- I Saldatore a stagno
- E Soldador de resistencia
- CN 电烙铁



HANGING DISPLAY COLOR BOX

YATO	W	max. temperature of soldering tip / max. temperatura grotu (°C)	dimensions of soldering tip / wymiary grotu (mm)	
YT-8271	30	400	ø3.8 x 70	16
YT-8272	60	500	ø6.0 x 78	16
YT-8273	80	520	ø6.8 x 64	16

- GB Transformer soldering gun
- D Lötpistole
- PL Lutownica transformatorowa
- RUS Паяльник электрический
- CZ Transformátorová páječka
- H Forrasztópáka
- RO Aparat de lipit letcon cu transformator
- F Fer à souder
- I Saldatore istantaneo
- E Soldador transformador
- CN 电烙铁



230V~50Hz	180 W	WORKING MODE TRYB PRACY S2 20%
-----------	-------	--------------------------------

LED

WORK LIGHT OŚWIETLENIE PRACY

BMC & COLOR SLEEVE

YATO	W	
YT-8245	180	10

- GB Soldering station
- D Lötstation
- PL Stacja lutownicza
- RUS Паяльная станция
- CZ Letovací stanice
- H Forrasztópáka állomás
- RO Stație de lipit
- F Station de soudage
- I Stazione digitale di saldatura
- E Estación de soldadura
- CN 数显焊台

230V~50Hz	48W	150-450°C	7.1mm 65mm	LCD DISPLAY
-----------	-----	-----------	---------------	----------------

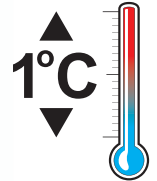

YATO	W	
YT-82455	48	4

- GB Electric glue gun
- D Heissklebepistole
- PL Pistolet do klejenia
- RUS Пистолет для клея
- CZ Pistolet na lepení
- H Ragasztópisztoly
- RO Pistol pt. lipit
- F Pistolet à colle
- I Pistola colla
- E Pistola de cola
- CN 热胶枪



230V~50Hz	35 (400) W	150-200°C	15 g/min
3-6 min	11 mm		

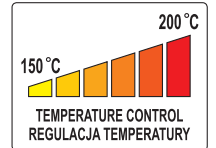

YATO	W	diameter of glue stick średnica wkladu (mm)	capacity wydajność (g/min)	
YT-82401	35 (400)	11	15	12/24

- GB PVC plastic pipe welder
- D Schweissgerät für thermoplastische Rohre
- PL Zgrzewarka do rur termoplastycznych
- RUS Сварочная машина для термопластиковых труба
- CZ Svářečka na termoplastické trubky
- H Hegesztő berendezés termoplasztikus csövekhez

- RO Masina de sudat tevi termoplastice
- F Soudeur en tuyauterie en PVC
- I Polifusore saldatore per tubi
- E Maquina de soldar las tubos termoplasticos
- CN 热熔器

230V~50Hz	850 W	0-300°C	16, 20, 25, 32 [mm]	40, 50, 63
-----------	-------	---------	---------------------	------------



YATO	W	
YT-82250	850	2

GB Gasoline generator
 D Stromgenerator
 PL Generator prądowórczy
 RUS Генератор тока
 CZ Generátor vytvářející proud
 H Áramfejlesztő generátorhoz
 RO Generator de curent
 F Groupe électrogène
 I Generatore di corrente
 E Generator de corriente
 CN 发电机



230V-50Hz
 2x
2.5 kW
 196 cm³
15 l
10.9 A

 EASY START
 ŁATWY ROZRUCH

GB Gasoline generator
 D Stromgenerator
 PL Generator prądowórczy
 RUS Генератор тока
 CZ Generátor vytvářející proud
 H Áramfejlesztő generátorhoz
 RO Generator de curent
 F Groupe électrogène
 I Generatore di corrente
 E Generator de corriente
 CN 发电机



230V-50Hz
 2x
3.2 kW
 242 cm³
25 l
13.9 A

 EASY START
 ŁATWY ROZRUCH



GREY
 CARTON BOX
 & COLOR
 LABEL

• spare parts available
 • dostępne części zamienne

YATO	kW	
YT-85432	2.5	1



GREY
 CARTON BOX
 & COLOR
 LABEL

• spare parts available
 • dostępne części zamienne

YATO	kW	
YT-85434	3.2	1

GB Gasoline generator
 D Stromgenerator
 PL Generator prądowórczy
 RUS Генератор тока
 CZ Generátor vytvářející proud
 H Áramfejlesztő generátorhoz
 RO Generator de curent
 F Groupe électrogène
 I Generatore di corrente
 E Generator de corriente
 CN 发电机



230V-50Hz
 2x
4.0 kW
 389 cm³
25 l
17.4 A

 EASY START
 ŁATWY ROZRUCH

GB Gasoline generator
 D Stromgenerator
 PL Generator prądowórczy
 RUS Генератор тока
 CZ Generátor vytvářející proud
 H Áramfejlesztő generátorhoz
 RO Generator de curent
 F Groupe électrogène
 I Generatore di corrente
 E Generator de corriente
 CN 发电机



230V-50Hz
 2x
5.0 kW
 389 cm³
25 l
21.7 A

 EASY START
 ŁATWY ROZRUCH



GREY
 CARTON BOX
 & COLOR
 LABEL

• spare parts available
 • dostępne części zamienne

YATO	kW	
YT-85437	4.0	1



GREY
 CARTON BOX
 & COLOR
 LABEL

• spare parts available
 • dostępne części zamienne

YATO	kW	
YT-85440	5.0	1

GB Gasoline generator
D Stromgenerator
PL Generator prądowórczy
RUS Генератор тока
CZ Generátor vytvářející proud
H Áramfejlesztő generátorhoz
RO Generator de curent
F Groupe électrogène
I Generatore di corrente
E Generator de corriente
CN 发电机

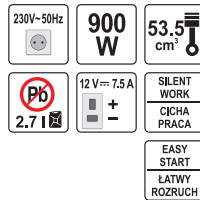

COLOR BOX



- electronics connection possibility
- spare parts available
- możliwość podłączenia elektroniki
- dostępne części zamienne

YATO	W	weight / waga (kg)	
YT-85421	900	48	1

GB Gasoline generator
D Stromgenerator
PL Generator prądowórczy
RUS Генератор тока
CZ Generátor vytvářející proud
H Áramfejlesztő generátorhoz
RO Generator de curent
F Groupe électrogène
I Generatore di corrente
E Generator de corriente
CN 发电机

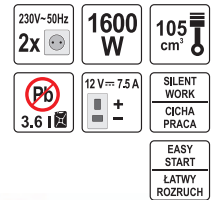

COLOR BOX



- electronics connection possibility
- spare parts available
- możliwość podłączenia elektroniki
- dostępne części zamienne

YATO	W	weight / waga (kg)	
YT-85422	1600	68	1

GB Gasoline water pump
D Pumpe mit verbrennungsmotor
PL Pompa spalinowa
RUS Бензонасос
CZ Čerpadlo se spalovacím motorem
H Robbanómotoros szivattyú
RO Pompa cu motor cu ardere internă
F Pompe à eau
I Motopompa
E Bomba de combustion
CN 汽油抽水泵

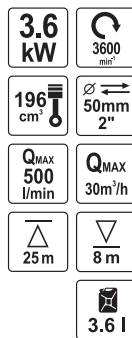

BROWN CARTON BOX & COLOR LABEL

YATO		
YT-85401		1

GB Gasoline water pump
D Pumpe mit verbrennungsmotor
PL Pompa spalinowa
RUS Бензонасос
CZ Čerpadlo se spalovacím motorem
H Robbanómotoros szivattyú
RO Pompa cu motor cu ardere internă
F Pompe à eau
I Motopompa
E Bomba de combustion
CN 汽油抽水泵



BROWN CARTON BOX & COLOR LABEL

YATO		
YT-85402		1

GB Gasoline water pump
D Pumpe mit verbrennungsmotor
PL Pompa spalinowa
RUS Бензонасос
CZ Čerpadlo se spalovacím motorem
H Robbanómotoros szivattyú
RO Pompa cu motor cu ardere internă
F Pompe à eau
I Motopompa
E Bomba de combustion
CN 汽油抽水泵

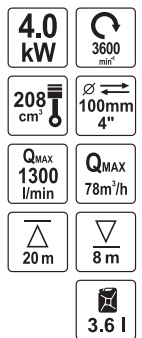

BROWN CARTON BOX & COLOR LABEL

YATO		
YT-85403		1

- GB Submersible pump for dirty water and wastewater
- D Tauchpumpe für Schmutzwasser
- PL Pompa zatapiałna do wody brudnej i ścieków
- RUS Погружной насос для грязной воды
- CZ Pohoné čerpadlo pro odpadní vody
- H Bűvárszivattyú szennyvíz
- RO Pompă submersibilă pt. apă uzată
- F Pompe submersible pour eaux usees
- I Pompa sommersa per acque reflue
- E Bomba sumergible para aguas residuales
- CN 污水和废水的潜水泵

230V~50Hz **750 W** Q max 16000 l/h

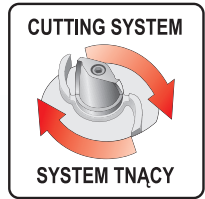

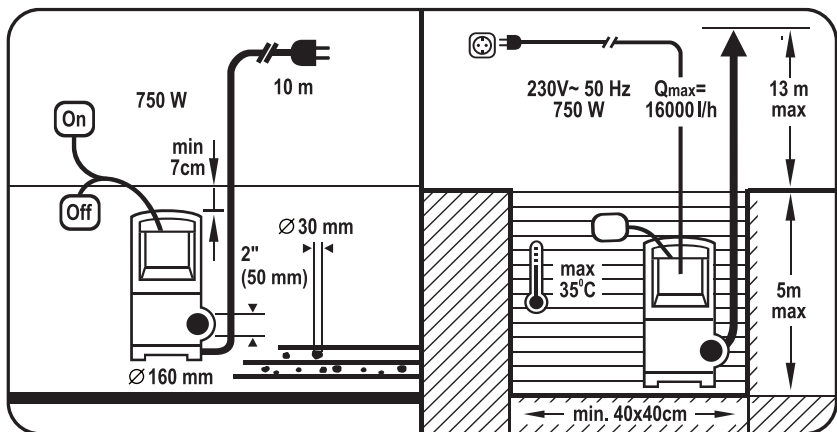

Δ [m]	Q [l/h]
0	16000
1	15000
2	14000
3	13500
4	12500
5	11500
6	11000
7	10500
8	9500
9	8000
10	5500
11	3500
12	2000
13	500

18



COLOR BOX

YATO 	W	l/h	H (max)	
YT-85350	750	16000	13	1



GB Cordless chainsaw
D Akku-kettensäge
PL Akumulatorowa pilarka łańcuchowa
RUS Аккумуляторная цепная пила
CZ Akumulátorová řetězová pila
H Akkus lánkfűrész

RO Ferăstraie cu lanț cu acumulator
F Tronçonneuse
I Motosega a batteria
E Inalámbrico motosierra
CN 无绳链锯

40 V	2.5 Ah	 12" 30.5 cm	 Li-Ion
<small>AUTOMATIC CHAIN LUBRICATION AUTOMATYCZNE SMAROWANIE ŁAŃCZUKU (TRZECIO)</small>	<small>TOOL-FREE ADJUSTMENT OF CHAIN TENSION BEZNAKŁADOWY REGULACJA NAPIĘCIA ŁAŃCUCHA</small>	<small>CHARGE LEVEL INDICATOR WSKAZNIK STANU NAŁADOWANIA BATERII</small>	<small>OIL TANK 0.18 l</small>



COLOR BOX

YATO 	V	
YT-85090	40	2



GB Battery
D Akkumulator
PL Akumulator
RUS Аккумулятор
CZ Akumulátor
H Akumulátor
RO Acumulatorul
F Batterie
I Batteria
E Bateria
CN 锂电池

40 V	2.5 Ah	100 Wh	<small>CHARGE LEVEL INDICATOR WSKAZNIK STANU NAŁADOWANIA BATERII</small>	 Li-Ion
----------------	------------------	------------------	--	---



WHITE CARTON BOX & COLOR LABEL

for / dla: YT-85090

YATO 	V	
YT-85132	40	10

GB Battery charger
D Ladegerät
PL Ładowarka
RUS Зарядное устройство
CZ Nabíječka
H Akkutöltő
RO Redresor
F Chargeur de batterie
I Caricabatteria
E Rectificador
CN 充电器

for/dla: 40V	230V~ 50Hz	for/dla:  Li-Ion	1h QUICK CHARGING SZYBŁA ŁADOWANIE	
------------------------	----------------------	---	---	---



WHITE CARTON BOX & COLOR LABEL

for / dla: YT-85090,
YT-85132

YATO 	V	
YT-85133	40	18

GB Cordless chainsaw
D Akku-kettensäge
PL Akumulatorowa pilarka łańcuchowa
RUS Аккумуляторная цепная пила
CZ Akumulátorová řetězová pila
H Akkus lánkfűrész

RO Ferăstraie cu lanț cu acumulator
F Tronçonneuse
I Motosega a batteria
E Inalámbrico motosierra
CN 无绳链锯

18 V	3.0 Ah	 10" 25 cm	 Li-Ion	<small>AUTOMATIC CHAIN LUBRICATION AUTOMATYCZNE SMAROWANIE ŁAŃCZUKU (TRZECIO)</small>	<small>OIL TANK 0.21 l</small>
----------------	------------------	---	---	---	------------------------------------



COLOR BOX

YATO 	V	
YT-85080	18	2

- GB Cordless pole saw
- D Akku-Hochentaster
- PL Akumulatorowa okrzesywarka na wysięgniku
- RUS Аккумуляторный телескопический высоторез
- CZ Akumulátorová vyvétvovací pila
- H Akumulátoros magassági ágnyeső
- RO Ferăstraie cu lanț cu telescopic
- F Elagueuse sur perche
- I Potatore a batteria
- E Sierra de pértiga telescópica
- CN 高枝锯

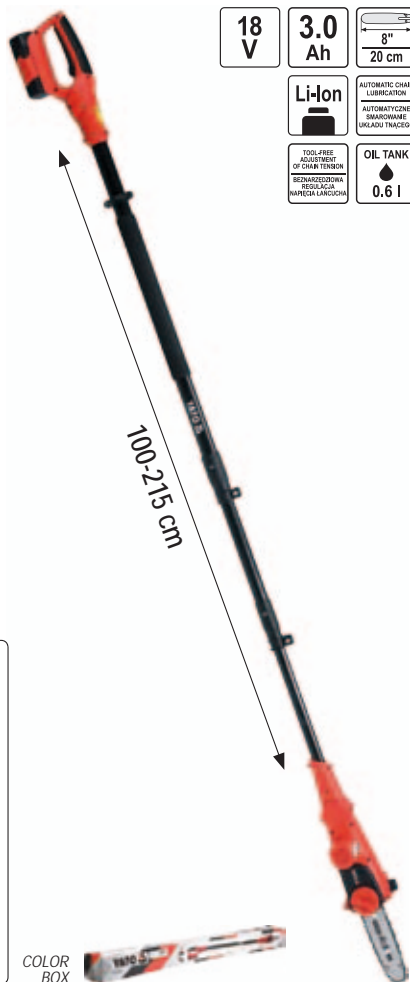

18 V 3.0 Ah 8" 20 cm

Li-Ion

TOOL-FREE ADJUSTMENT OF CHAIN TENSION
BEZPŁATNE DOKŁADNIENIE NAPIĘCIA ŁAŃCOWY
MAREKKA ŁAŃCOWY

AUTOMATIC CHAIN LUBRICATION
AUTOMATYCZNE SMAROWANIE ŁAŃCOWY (TRACED)

OIL TANK 0.6 l

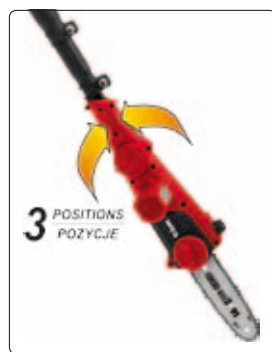

COLOR BOX

YATO	V	
YT-85120	18	2

- GB Cordless grass trimmer
- D Akku-Rasentrimmer
- PL Akumulatorowa podkaszarka do trawy
- RUS Аккумуляторный телескопический высоторез
- CZ Akumulátorová sekačka na trávu
- H Akkus szegélynyíró
- RO Trimmer de gazon cu acumulator
- F Coupe bordures sans fil
- I Tosaerba a filo a batteria
- E Desmalezadora inalámbrico
- CN 打草机

COLOR BOX



18 V 3.0 Ah 8800 min⁻¹ Li-Ion 250mm



YATO	V	
YT-85110	18	4

- GB Cordless hedge trimmer
- D Akku-Heckenschere
- PL Akumulatorowe nożyce do żywoplotu
- RUS Аккумуляторный кусторез
- CZ Akumulátorové nůžky na živé ploty
- H Akkus sövénynyíró
- RO Foarfece de tăiat gard viu cu acumulator
- F Taille-haies sans fil
- I Tagliasiepi a batteria
- E Cortasetos inalámbrico
- CN 充电式修枝剪



18 V 3.0 Ah Li-Ion 2400 min⁻¹ 450mm

COLOR BOX

YATO	V	
YT-85100	18	2

- GB Battery
- D Akkumulator
- PL Akumulator
- RUS Аккумулятор
- CZ Akumulátor
- H Akumulátor
- RO Acumulatorul
- F Batterie
- I Batteria
- E Bateria
- CN 锂电池



18 V 3.0 Ah 54 Wh Li-Ion

WHITE CARTON BOX & COLOR LABEL

for / dla: YT-85080, YT-85100, YT-85110, YT-85120

YATO	V	
YT-85130	18	18

- GB Battery charger
- D Ladegerät
- PL Ładowarka
- RUS Зарядное устройство
- CZ Nabíječka
- H Akkutöltő
- RO Redresor
- F Chargeur de batterie
- I Caricabatteria
- E Rectificador
- CN 充电器



for/dla: 18V 230V~50Hz for/dla: Li-Ion

WHITE CARTON BOX & COLOR LABEL

for / dla: YT-85080, YT-85100, YT-85110, YT-85120, YT-85130



YATO	V	
YT-85131	18	27

- GB Electric chainsaw
- D Kettensäge
- PL Piłarka elektryczna
- RUS Электропила цепная
- CZ Elektrická pila
- H Elektromos fűrész
- RO Ferăstrău cu lanț
- F Tronçonneuse électrique
- I Motosega elettrica
- E Motosierra eléctrica
- CN 电链锯

2.2 kW	230V~ 50Hz	16" 40 cm	AUTOMATIC CHAIN LUBRICATION AUTOMATYCZNE SMAROWANIE LINKARU łańcucha	100% FREE ADJUSTMENT OF CHAIN TENSION BEZNAPIĘCZNA REGULACJA NAPIĘCIA ŁAŃCUCHA	OIL TANK 0.23 l	
------------------	----------------------	---------------------	--	---	---------------------------	---



COLOR
BOX

YATO 	kW	
YT-84920	2.2	2

- GB Gasoline backpack sprayer
- D Benzin Motorsprüher
- PL Opryskiwacz plecakowy spalinowy
- RUS Бензиновый ранец-опрыскиватель
- CZ Motorový rosič
- H Benzines permetező
- RO Pulverizatoare pe benzina
- F Pulvérisateur à essence
- I Atomizzatore
- E Pulverizador de gasolina
- CN 喷雾喷粉机

2.13 kW 2.9 KM	41.5 cm	12 m max	≤3 l/min	16 l
--------------------------	-------------------	--------------------	-----------------	-------------



WHITE
CARTON BOX
& COLOR
LABEL



YATO 	kW	KM	
YT-85140	2.13	2.9	1

- GB Gasoline chainsaw
- D Motorsägen
- PL Piłarka spalinowa
- RUS Бензопила
- CZ Motorová pila
- H Benzin láncfűrész
- RO Drujba pe benzina
- F Tronçonneuses
- I Motosega a benzina
- E Motosierra de gasolina
- CN 油锯

1.8 kW 2.4 KM	45 cm ³	C max 11000 min ⁻¹	AUTOMATIC CHAIN LUBRICATION AUTOMATYCZNE SMAROWANIE ŁKADKĄ TRĄCZOSZĄ	ANTI-VIBRATION SYSTEM SYSTEM ANTYWIBRACYJNY	18" 44 cm
+2		0.325" 8.255 mm	0.058" 1.5 mm	OIL TANK 40 : 1 0.26 l	



Matching YATO bars / Pasujące prowadnice z programu YATO: YT-84934, YT-84936
 Matching YATO chains / Pasujące łańcuchy z programu YATO: YT-84940, YT-84941, YT-84942, YT-84943, YT-84944



**QUICK CHANGE
OF AIR FILTER
ŁATWA WYMIANA FILTRA
POWIETRZA**

**POCKET FOR UNIVERSAL WRENCH
SCHOWEK NA KLUCZ UNIWERSALNY**

YATO	kW	KM	L (mm)	
YT-84900	1.8	2.4	440	1

- GB Gasoline chainsaw
- D Motorsägen
- PL Piłarka spalinowa
- RUS Бензопила
- CZ Motorová pila
- H Benzin láncfűrész
- RO Drujba pe benzina
- F Tronçonneuses
- I Motosega a benzina
- E Motosierra de gasolina
- CN 油锯

2.0 kW 2.7 KM	49.3 cm ³	C max 8500 min ⁻¹	AUTOMATIC CHAIN LUBRICATION AUTOMATYCZNE SMAROWANIE ŁKADKĄ TRĄCZOSZĄ	ANTI-VIBRATION SYSTEM SYSTEM ANTYWIBRACYJNY	20" 50 cm
+2		0.325" 8.255 mm	0.05" 1.3 mm	OIL TANK 40 : 1 0.26 l	



Matching YATO bars / Pasujące prowadnice z programu YATO: YT-84933
 Matching YATO chains / Pasujące łańcuchy z programu YATO: YT-84945



**QUICK CHANGE
OF AIR FILTER
ŁATWA WYMIANA FILTRA
POWIETRZA**



**POCKET FOR UNIVERSAL WRENCH
SCHOWEK NA KLUCZ UNIWERSALNY**

YATO	kW	KM	L (mm)	
YT-84905	2.0	2.7	500	1

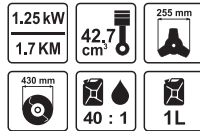
GB Brushcutter
D Motorsensen
PL Kosa spalinowa
RUS Бензокоса
CZ Motorový křovinořez
H Motoros kasza
RO Motocoasa
I Falce fienaiia a benzina
E Motoguadaña de gasolina
CN 割草机



COLOR BOX

YATO 	kW	KM	
YT-85000	1.25	1.7	1

GB Brushcutter
D Motorsensen
PL Kosa spalinowa
RUS Бензокоса
CZ Motorový křovinořez
H Motoros kasza
RO Motocoasa
I Falce fienaiia a benzina
E Motoguadaña de gasolina
CN 割草机

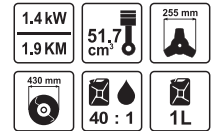



COLOR BOX

YATO 	kW	KM	
YT-85002	1.4	1.9	1

GB Petrol hedge trimmer
D Benzin-Heckenscheren
PL Spalinowe nożyce do żywoplotu
RUS Бензоножницы
CZ Plotostřih na živé ploty
H Benzines sövényvágó
RO Tuns gard viu
F Taille-haie
I Tosasiepi per privati
E Corta sebes a gasolina
CN 绿篱剪



COLOR BOX

YATO 	kW	KM	L (mm)	
YT-85021	0.7	0.99	550	1

GB Chainsaw guide bar / CZ Vodicí lišta k řetězové pile / I Barra per motosega
 D Kettensägeführung / H Láncevezető / E Barra guia motosierra
 PL Prowadnica do pił łańcuchowych / RO Lama de ghidai pt. ferastrau / CN 导板
 RUS Шина для бензопил / F Guide de tronçonneuse

COLOR PAPER POUCH

Mn 65



for / dla: YT-84950, YT-84960

competitors / odpowiedniki: Oregon: 140SPEA074; Alpina: 4112560; Stihl: 3005 000 809; Windsor: 14ST50SSR
 for / dla: Alpina: 270, 280, Elletra 160, Elletra 170, Energy 1.6, Energy 1.8, P360, P361, P370, P390, P391, Sinergy 35, Sinergy 40; Oleo-Mac: 240, OEM200; Stihl: 009, 010, 011, 012, 017, 018, 019, 019T, 020, 020T, 021, 021C, 023, 025, 25, MS160, MS170, MS180, MS181, MS191, MS192, MS200, MS200T, MS210, MS211, MS230, MS231, MS241, MS250, MS251, MSE140, MSE200

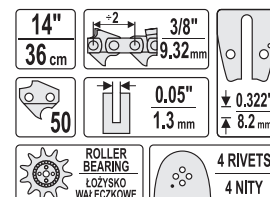

YATO	size / rozmiar	
YT-84930	14" (36 cm)	20



for / dla: YT-84951, YT-84960

competitors / odpowiedniki: Oregon: 140SDEA041; Oleo-mac: 50030218; Husqvarna: 501854149; Windsor: 14PKU50SSR; Makita: 442035661, 472035661, 482035661; Alpina: 4112300; Dolmar: 412035661, 452035661, 462035661; Partner: 530044328

for / dla: Al-Ko: 2000, 2300, 25A, E1200, E125, E1400, E1500, KE3500, VARIO, KE4000, KS, KSB; Alpina: 352, 382, A10E, A14E, E120, E130, E150, ELECTRIC, ES182, ES202, KS1400B, KS1500B; Bosch: 1586, 40-19PRO, AKE30B, AKE30LI, AKE35-19PRO, AKE35B, AKE40B, BULLCRAFT, GKE35BC, GKE40BC, PKE25, PKE30B, PKE35B, PKE40; Dolmar: 100, 101, 102, 103, 104, 105, 106, 108, 275, 285, ES140, ES151, ES152, ES152A, ES153, ES160, ES161, ES162, ES162A, ES163, ES172, ES172A, ES173, ES183, ES2035, ES2040, ES3, ES30, ES37, ES40, ES41, ES6, PS33, PS330, PS3300TH, PS34, PS340, PS341, PS3410, PS344, PS350, PS390, PS400, PS401, PS41, PS45; Echo: CS2600ES, CS260TES, CS2700ES, CS310WES, CS3500ES, CS350WES, CS351WES; Einhell: BG-EC-1840TC, BG-PC-4040, EKS1650, KSE, KSE1435, KSE1635, KSE1640, KSE2000, PES1540, PES1640, PES30, PES34, PES35, PES40, PKS1635, PKS1840, PROF: Hitachi: CS280A, CS280B, CS30EH, CS350A, CS350B, CS35B; Homelite: 20AV, 23AV, 27, 3300, 3335, 350, 3550, 3800, 3850, 4500, 4550, S40, HCS3335, HCS4041CA, PS33, RANGER, TIMBERMAN, UT10901, UT10926, UT10974; Husqvarna: 23, E16, E316, E317, E321, T425; Jonsered: 2033TH; Makita: 5012, 5014, 5016, BUC122RFE, BUC250RDE, DCS232T, DCS300, DCS330S, DCS340, DCS341, DCS3410TH, DCS350, DCS3501, DCS380, DCS390, DCS400, DCS401, DCS4610, EA3201, EA3500F35B, EA3500F40B, UC250DWB, UC3000, UC3030A, UC3500, UC3501, UC3520A, UC3530AK, UC4000, UC4020A, UC4030AK, UC4530A; McCulloch: 10-42, 10-49, 335, 435, 440, 441, 442, 4600, 4700, 4900, 5000, 738, TIMBERBEAR-849, TITAN41, TITAN46; Oleo-Mac: 931, 932, GS35, GS350, GS370, GS410C; Partner: 330, 335, 340, 345, 350, 351, 352, 360, 370, 385, 391, 395, P390, P420, P842; Ryobi: APR02, PCN3335; Skil: 1620U, 1634U, 1636U

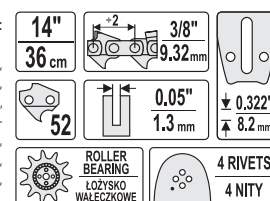

YATO	size / rozmiar	
YT-84931	14" (36 cm)	20



for / dla: YT-84961

competitors / odpowiedniki: Oregon: 158SLHD009; Husqvarna: 508914356; Windsor: 15HS58SPNA
 for / dla: Alpina: P660, P680, P700, P750, P800, PROF700, PROF800; Dolmar: PS6400, PS6400H, PS7300, PS7300H, PS7900, PS7900H, PS9000, PS9010; Dolpima: PS190, PS290, PS390, PS490; Echo: CS3500, CS350WES, CS351WE; Husqvarna: 1100, 160, 162, 181, 2100XP, 2101, 2101XP, 260, 266, 268, 272, 281XP, 285, 288XP, 298, 298X, 298XG, 3120, 3120XP, 365, 371, 371XP, 371XPG, 372, 372XP, 372XPG, 380, 385, 385XP, 394, 394XP, 394XPG, 395, 395XP, 395XPG, 480, 562XP, 570, 575, 575XP, 576XP, 61, 64, 65, 66, 70, 77; Jonsered: 1020, 2065, 2071, 2077, 2083, 2094, 2095, 2165, 2171, 2186, 625, 630, 630 SUPER, 670, 670 CHAMP, 820; Makita: DCS6400, DCS6401, DCS7300, DCS7301, DCS7900, DCS79001, DCS9000, DCS9010; Partner: 660, 710, P7700; Solo: 603, 662, 665, 667, 670, 675, 680, 681, 690, 694

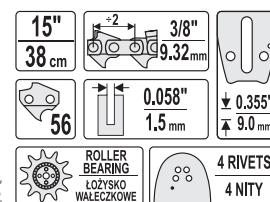

YATO	size / rozmiar	
YT-84932	15" (38 cm)	20



for / dla: YT-84905, YT-84945, YT-84962

competitors / odpowiedniki: Oregon: 50MLBK095; Dolmar: 415038141; Husqvarna: 508926164, 508926364; Makita: 445038141; Windsor: 15CJL50SPYJ
 for / dla: Dolmar: 109, 110, 111, 112, 113, 114, 115, 116, PS460, PS4600, PS4605, S500, PS5000, PS510, PS5100S, PS540; Husqvarna: 133, 136, 137, 141, 142, 154, 234, 238, 240, 242, 242XP, 246, 254, 257, 261, 262, 339XP, 340, 345, 346, 346XP, 350, 351, 353, 357, 357XP, 359, 36, 40, 41, 42, 435, 435E, 44, 440E, 444, 445, 445E, 45, 450E, 455 RANCHER, 455E RANCHER, 460, 460 RANCHER, 50, 51, 550, 560XP, T435; Jonsered: 2012, 2014, 2015, 2016, 2036, 2040, 2041, 2045, 2050, 2051, 2054, 2055, 2063, 2141, 2145, 2147, 2149, 2150, 2152, 2153, 2155, 2156, 2159, 2163, 370, 380, 410, 420, 425, 435, 45, 450, 451, 451EVS, 452, 455, 490, 495SP, 50, 51, 510, 52, 520, 521, 525, 535, 590, CS2149W, CS2152W; Makita: 45, DCS430, DCS43001, DCS43001, DCS43001, DCS4301, DCS431, DCS460, DCS4600S, DCS4600S, DCS500, DCS5000, DCS5000, DCS5030, DCS520, DCS5200; Oleo-Mac: 850, 938, 940, 941, 942, 942C, 945, 946, 947, 950, 950 Super, 950A, 951, 952, 956, 962 E300F, GS410CX, GS44; Partner: 1200EL, 1400EL, 1450EL, 1500EL, 1650EL, 365, 400, 405, 410, 450, 460, 465, 470, 495, 500, 510, 540, 545, P500, P5000, P5500; Solo: 639, 641, 644, 645, 647, 650, 651, 652, 656, 665

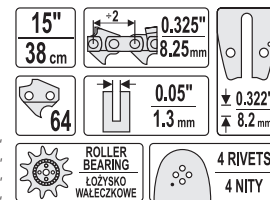

YATO	size / rozmiar	
YT-84933	15" (38 cm)	20



for / dla: YT-84900, YT-84941, YT-84963

competitors / odpowiedniki: Oregon: 158PXBK095; Dolmar: 415038631; Husqvarna: 508912164, 508912364; Makita: 445038631; Solo: 6900343, 6900343K, 6900343N
 for / dla: Dolmar: 109, 110, 111, 112, 113, 114, 115, 116, ES1800, PS460, PS4600, PS4605, PS500, PS5000, PS510, PS5100S, PS540; Homelite: 250, 252, 290, 290C, 300, 300, 340, 340C, 3850B, 3850C, 4045, 415B, 444, 4550B, HCS4040, HCS4446CA; Husqvarna: 133, 136, 137, 141, 142, 154, 234, 235, 238, 240, 242, 242XP, 246, 254, 257, 261, 262, 339XP, 340, 345, 346, 346XP, 350, 351, 353, 357, 357XP, 359, 36, 40, 41, 42, 435, 435E, 44, 440, 440E, 444, 445, 445E, 45, 450E, 455 RANCHER, 455E RANCHER, 460, 460 RANCHER, 50, 51, 550, 560XP, T435; Jonsered: 2012, 2014, 2015, 2016, 2036, 2040, 2041, 2045, 2050, 2051, 2054, 2055, 2063, 2141, 2145, 2147, 2149, 2150, 2152, 2153, 2155, 2156, 2159, 2163, 370, 380, 410, 420, 425, 435, 45, 450, 451, 451EVS, 452, 455, 490, 495SP, 50, 51, 510, 52, 520, 521, 525, 535, 590, CS2149W, CS2152W; Makita: 45, DCS430, DCS43001, DCS43001, DCS4301, DCS431, DCS460, DCS4600S, DCS500, DCS5000, DCS5000, DCS5030, SPS01-45, SPS01-52, SPS02-45, YD 40/45, YD40, YD52; Oleo-Mac: 850, 938, 940, 941, 942, 942C, 945, 946, 947, 950, 950 Super, 950A, 951, 952, 956, 962 E300F; Partner: 365, 400, 405, 410, 450, 460, 465, 470, 495, 500, 510, 540, 545, P500, P5000, P5500

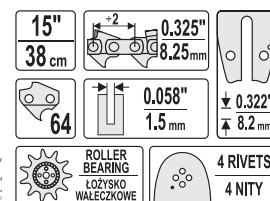

YATO	size / rozmiar	
YT-84934	15" (38 cm)	20

GB Chainsaw guide bar
D Kettensägeführung
PL Prowadnica do pił łańcuchowych
RUS Шина для бензопил

CZ Vodicí lišta k řetězové pile
H Láncevezető
RO Lama de ghidai pt. ferastrau
F Guide de tronçonneuse

I Barra per motosega
E Barra guia motosierra
CN 导板

COLOR
PAPER
POUCH



Mn
65



for / dla: YT-84953, YT-84960

competitors / odpowiedniki: Oregon: 160SDEA041; Oleo-Mac: 50050092; Husqvarna: 530044508; Windsor: 16PKU50SSR; Makita: 442040661, 442040061; Alpina: 4112500; Partner: 530044329

for / dla: Al-Ko: 2000, 2300, 25A, E1200, E125, E1400, E1500, KE3500 VARIO, KE4000, KS, KSB; Alpina: 352, 382, A10E, A14E, E120, E130, E150, ELECTRIC ES182, ES202, KS1400B, KS1500B; Dolmar: 100, 101, 102, 103, 104, 105, 106, 108, 275, 285, ES140, ES151, ES152, ES152A, ES153, ES160, ES161, ES162, ES162A, ES163, ES172, ES172A, ES173, ES183, ES2035, ES2040, ES3, ES30, ES37, ES40, ES41, ES6, PS33, PS330, PS3300TH, PS34, PS340, PS341, PS3410, PS344, PS350, PS390, PS400, PS401, PS41, PS45; Echo: CS2600ES, CS260TES, CS2700ES, CS310WES, CS3500ES, CS350WES, CS351WES, CS360WES; Hitachi: CS280A, CS280B, CS280C, CS350A, CS350B, CS35B; Homelite: 20AV, 23AV, 27, 3300, 3335, 3350, 3550, 3800, 3850, 4500, 4550, CS40, HCS3335, HCS4041CA, PS33, RANGER, TIMBERMAN, UT10901, UT10926, UT10974; Husqvarna: 23, E16, E316, E317, E321, T425; Jonsered: 2033TH; Makita: 5012, 5014, 5016, BUC122RFE, BUC250RDE, DCS230T, DCS300, DCS300S, DCS330, DCS330S, DCS340, DCS340, DCS341, DCS3410TH, DCS350, DCS3500, DCS3501, DCS3520A, DCS380, DCS390, DCS400, DCS401, DCS4610, UC3000, UC3030A, UC3500, UC3501, UC3520A, UC3530AK, UC4000, UC4030AK; McCulloch: 338, 442; Oleo-Mac: 931, 932, GS35, GS350, GS370, GS410C; Partner: 330, 335, 340, 345, 350, 351, 352, 360, 370, 385, 391, 395, P390, P420, P842; Ryobi: APR02, PCN3335

16" 40 cm		3/8" 9.32 mm	
56		0.05" 1.3 mm	0.322" 8.2 mm
	ROLLER BEARING ŁOŻYSKO WALECZKOWE		4 RIVETS 4 NITY
YATO size / rozmiar		YT-84953 16" (40 cm) 20	



for / dla: YT-84900, YT-84943, YT-84963

competitors / odpowiedniki: Oregon: 188SLGK095; Dolmar: 415045631; Makita: 415045631; Windsor: 18CJL58SPYJ9

for / dla: Dolmar: 109, 110, 111, 112, 113, 114, 115, 116, ES1800, PS460, PS4600, PS4605, PS500, PS5000, PS510, PS5100S, PS540; Homelite: 250, 252, 290, 290C, 300, 340, 340C, 3850B, 3850C, 4045, 415B, 444, 4550B, HCS4040, HCS4446CA; Husqvarna: 133, 136, 137, 141, 142, 154, 234, 238, 240, 242, 242XP, 246, 254, 257, 261, 262, 339XP, 340, 345, 346, 346XP, 350, 351, 353, 357, 357XP, 359, 36, 40, 41, 42, 435, 435E, 44, 440, 440E, 444, 445, 445E, 45, 450E, 455 RANCHER, 455E, RANCHER, 460, 460 RANCHER, 50, 51, 550, 560XP, T435; Jonsered: 2012, 2014, 2015, 2016, 2036, 2040, 2041, 2045, 2050, 2051, 2054, 2055, 2063, 2141, 2145, 2147, 2149, 2150, 2152, 2153, 2155, 2156, 2159, 2163, 370, 380, 410, 420, 425, 435, 45, 450, 451, 451EVS, 452, 455, 490, 495, P50, 51, 510, 52, 520, 521, 525, 535, 590, CS2149W, CS2152W; Makita: 45, DCS430, DCS43001, DCS4300I, DCS431, DCS460, DCS4600S, DCS500, DCS5000, DCS5030, DCS520, DCS5200I; NAC: NO-CS38, SPS01-45, SPS01-52, SPS02-45, YD 40/45, YD40, YD52; Oleo-Mac: 850, 938, 940, 941, 942, 942C, 945, 946, 947, 950, 950 Super, 950A, 951, 952, 956, 962, E300F; Partner: 365, 400, 405, 410, 450, 460, 465, 470, 495, 500, 510, 540, 545, P500, P5000, P5500; Solo: 639, 641, 644, 645, 647, 650, 651, 652, 656, 665

18" 45 cm		0.325" 8.25 mm	
72		0.058" 1.5 mm	0.322" 8.2 mm
	ROLLER BEARING ŁOŻYSKO WALECZKOWE		4 RIVETS 4 NITY
YATO size / rozmiar		YT-84936 18" (45 cm) 20	

GB Chain for chainsaw
D Kette für Kettensägen
PL Łańcuch tnący do pił
RUS Цепь для бензопилы

CZ Řetěz pro řetězové pily
H Lánclánzfűrész
RO Lant pt. drijba
F Chaîne de tronçonneuse

I Taglio per motoseghea
E Cadena de motosierra
CN 鏈沫

COLOR BOX
WITH EURO HOLE



for / dla: YT-84900

for / dla: Alpina: A40, A40E, P400, P450, P460, P500, P510, P522, PRO540, PRO600, PROF-41, PROF-45; Dolmar: 109, 110, 111, 112, 113, 114, 115i, 116, ES1800, PS460, PS4600, PS4605, PS500, PS5000, PS510, PS5100S, PS540; Echo: CS4200ES, CS4400; Homelite: 250, 252, 290, 290C, 300, 340, 340C, 3850B, 3850C, 415B, 444, 4550B, HCS4040, HCS4045, HCS4446CA; Husqvarna: 133, 136, 137, 140, 141, 142, 154, 234, 235, 238, 240, 240e, 242, 242XP, 246, 254, 254XP, 257, 261, 262, 338XPT, 339XP, 340, 345, 346, 346XP, 350, 351, 353, 357, 357XP, 359, 36, 365, 372XP, 40, 41, 42, 435, 435E, 44, 444, 445, 445E, 45, 450E, 455 RANCHER, 455E RANCHER, 460 RANCHER, 50, 51, 55, T435; Jonsered: 520, 2012, 2014, 2015, 2016, 2036, 2040, 2041, 2045, 2050, 2051, 2054, 2055, 063, 2141, 2145, 2147, 2149, 2150, 2152, 2153, 2155, 2156, 2159, 2163, 370, 380, 410, 420, 425, 435, 45, 450, 451, 451EVS, 452, 455, 490, 495, 495SP, 50, 51, 510, 52, 521, 525, 535, 590, CS2149W, CS2152W; Makita: 45, DCS430, DCS43001, DCS4300I, DCS431, DCS460, DCS4600S, DCS4630, DCS500, DCS5000, DCS5030, DCS520, DCS5200I; NAC: NO-CS38, SPS01-45, SPS01-52, SPS02-45, YD 40/45, YD40, YD52; Oleo-Mac: 850, 938, 940, 941, 942, 945, 946, 947, 950, 950 Super, 950A, 951, 952, 956, 962, E300F; Partner: 1650, 365, 400, 405, 410, 450, 460, 465, 470, 495, 500, 510, 540, 545, P500, P5000, P5500

14" 36 cm		0.325" 8.25 mm	56
	0.058" 1.5 mm		SEMI-CHISEL POL-OLITO
	LUBRICATION SYSTEM SYSTEM SMAROWANIA		
YATO size / rozmiar		YT-84940 14" (36 cm) 50	



for / dla: YT-84900, YT-84934

for / dla: Dolmar: 109, 110, 111, 112, 113, 114, 115i, 116, ES1800, PS460, PS4600, PS4605, PS500, PS5000, PS5510, PS5100S, PS540; Husqvarna: 154, 257, 440e, 133, 136, 137, 140, 141, 142, 234, 235, 238, 240, 240e, 242, 242XP, 246, 254, 254XP, 261, 262, 338XPT, 339XP, 340, 345, 346, 346XP, 350, 351, 353, 357, 357XP, 359, 36, 365, 372XP, 40, 41, 42, 435, 435E, 44, 444, 445, 445E, 45, 450E, 455 RANCHER, 455E RANCHER, 460 RANCHER, 50, 51, 55, T435; Jonsered: 520, 2012, 2014, 2015, 2016, 2036, 2040, 2041, 2045, 2050, 2051, 2054, 2055, 063, 2141, 2145, 2147, 2149, 2150, 2152, 2153, 2155, 2156, 2159, 2163, 370, 380, 410, 420, 425, 435, 45, 450, 451, 451EVS, 452, 455, 490, 495, 495SP, 50, 51, 510, 52, 521, 525, 535, 590, CS2149W, CS2152W; Makita: 45, DCS430, DCS43001, DCS4300I, DCS431, DCS460, DCS4600S, DCS4630, DCS500, DCS5000, DCS5030, DCS520, DCS5200I; NAC: NO-CS38, SPS01-45, SPS01-52, SPS02-45, YD 40/45, YD40, YD52; Oleo-Mac: 850, 938, 940, 941, 942, 945, 946, 947, 950, 950 Super, 950A, 951, 952, 956, 962, E300F; Partner: 1650, 365, 400, 405, 410, 450, 460, 465, 470, 495, 500, 510, 540, 545, P500, P5000, P5500

15" 38 cm		0.325" 8.25 mm	64
	0.058" 1.5 mm		SEMI-CHISEL POL-OLITO
	LUBRICATION SYSTEM SYSTEM SMAROWANIA		
YATO size / rozmiar		YT-84941 15" (38 cm) 50	



for / dla: YT-84900

for / dla: Dolmar: 109, 110, 111, 112, 113, 114, 115i, 116, ES1800, PS460, PS4600, PS4605, PS500, PS5000, PS5510, PS5100S, PS540; Husqvarna: 154, 257, 440e, 133, 136, 137, 140, 141, 142, 234, 235, 238, 240, 240e, 242, 242XP, 246, 254, 254XP, 261, 262, 338XPT, 339XP, 340, 345, 346, 346XP, 350, 351, 353, 357, 357XP, 359, 36, 365, 372XP, 40, 41, 42, 435, 435E, 44, 444, 445, 445E, 45, 450E, 455 RANCHER, 455E RANCHER, 460 RANCHER, 50, 51, 55, T435; Jonsered: 520, 2012, 2014, 2015, 2016, 2036, 2040, 2041, 2045, 2050, 2051, 2054, 2055, 063, 2141, 2145, 2147, 2149, 2150, 2152, 2153, 2155, 2156, 2159, 2163, 370, 380, 410, 420, 425, 435, 45, 450, 451, 451EVS, 452, 455, 490, 495, 495SP, 50, 51, 510, 52, 521, 525, 535, 590, CS2149W, CS2152W; Makita: 45, DCS430, DCS43001, DCS4300I, DCS431, DCS460, DCS4600S, DCS4630, DCS500, DCS5000, DCS5030, DCS520, DCS5200I; NAC: NO-CS38, SPS01-45, SPS01-52, SPS02-45, YD 40/45, YD40, YD52; Oleo-Mac: 850, 938, 940, 941, 942, 945, 946, 947, 950, 950 Super, 950A, 951, 952, 956, 962, E300F; Partner: 1650, 365, 400, 405, 410, 450, 460, 465, 470, 495, 500, 510, 540, 545, P500, P5000, P5500

16" 40 cm		0.325" 8.25 mm	66
	0.058" 1.5 mm		SEMI-CHISEL POL-OLITO
	LUBRICATION SYSTEM SYSTEM SMAROWANIA		
YATO size / rozmiar		YT-84942 16" (40 cm) 50	

GB Chain for chainsaw
D Kette für Kettensägen
PL Łańcuch łańcuch do pił
RUS Цепь для бензопилы

CZ Řetěz pro řetězové pily
H Lánca láncfűrész
RO Lant pt. drijba
F Chaîne de tronçonneuse

I Taglio per motoseghea
E Cadena de motosierra
CN 锯沫

COLOR BOX
WITH EURO HOLE



KICKBACK REDUCTION
REDUKCIJA ODRZUTU
VIBRATION REDUCTION
REDUKCIJA WBRACJA
Mn 65



for / dla: YT-84900, YT-84936

for / dla: Dolmar: 109, 110, 111, 112, 113, 114, 115i, 116, ES1800, PS460, PS4600, PS4605, PS500, PS5000, PS5510, PS5100S, PS540; Husqvarna: 154, 257, 440e, 133, 136, 137, 140, 141, 142, 234, 235, 238, 240, 240e, 242, 242XP, 246, 254, 254XP, 261, 262, 338XPT, 339XP, 340, 345, 346, 346XP, 350, 351, 353, 357, 357XP, 359, 36, 365, 372XP, 40, 41, 42, 435, 435E, 44, 444, 445, 445E, 45, 450E, 455 RANCHER, 455E RANCHER, 460 RANCHER, 50, 51, 55, T435; Jonsered: 520, 2012, 2014, 2015, 2016, 2036, 2040, 2041, 2045, 2050, 2051, 2054, 2055, 063, 2141, 2145, 2147, 2149, 2150, 2152, 2153, 2155, 2159, 2163, 370, 380, 410, 420, 425, 435, 45, 450, 451, 451EVS, 452, 455, 490, 495P, 50, 51, 510, 52, 521, 525, 535, 590, CS2149W, CS2152W; Makita: 45, DCS430, DCS43001, DCS43001, DCS431, DCS460, DCS4600S, DCS4630, DCS500, DCS5000, DCS5030, DCS5200; Oleo-Mac: 850, 938, 940, 941, 942, 945, 946, 947, 950, 950 Super, 950A, 951, 952, 956, 962, E300F; Partner: 1650, 365, 400, 405, 410, 450, 460, 465, 470, 495, 500, 510, 540, 545, P500, P5000, P5500

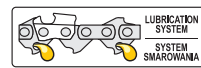
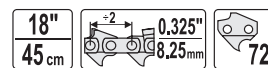

YATO	size / rozmiar	
YT-84943	18" (45 cm)	50



for / dla: YT-84900

for / dla: Dolmar: 109, 110, 111, 112, 113, 114, 115i, 116, ES1800, PS460, PS4600, PS4605, PS500, PS5000, PS5510, PS5100S, PS540; Husqvarna: 154, 257, 440e, 133, 136, 137, 140, 141, 142, 234, 235, 238, 240, 240e, 242, 242XP, 246, 254, 254XP, 261, 262, 338XPT, 339XP, 340, 345, 346, 346XP, 350, 351, 353, 357, 357XP, 359, 36, 365, 372XP, 40, 41, 42, 435, 435E, 44, 444, 445, 445E, 45, 450E, 455 RANCHER, 455E RANCHER, 460 RANCHER, 50, 51, 55, T435; Jonsered: 520, 2012, 2014, 2015, 2016, 2036, 2040, 2041, 2045, 2050, 2051, 2054, 2055, 063, 2141, 2145, 2147, 2149, 2150, 2152, 2153, 2155, 2159, 2163, 370, 380, 410, 420, 425, 435, 45, 450, 451, 451EVS, 452, 455, 490, 495P, 50, 51, 510, 52, 521, 525, 535, 590, CS2149W, CS2152W; Makita: 45, DCS430, DCS43001, DCS43001, DCS431, DCS460, DCS4600S, DCS4630, DCS500, DCS5000, DCS5030, DCS5200; Oleo-Mac: 850, 938, 940, 941, 942, 945, 946, 947, 950, 950 Super, 950A, 951, 952, 956, 962, E300F; Partner: 1650, 365, 400, 405, 410, 450, 460, 465, 470, 495, 500, 510, 540, 545, P500, P5000, P5500

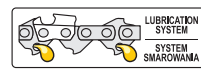
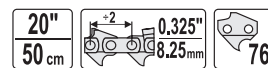

YATO	size / rozmiar	
YT-84944	20" (50 cm)	50



for / dla: YT-84905, YT-84933

for / dla: Dolmar: 109, 110, 111, 112, 113, 114, 115i, 116, PS460, PS4600, S4605, PS500, PS5000, PS510, PS5100S, PS540; Husqvarna: 133, 136, 137, 141, 142, 154, 234, 238, 240, 242, 42XP, 246, 254, 254XP, 257, 261, 262, 338XPT, 339XP, 340, 345, 346, 346XP, 350, 351, 353, 357, 357XP, 359, 36, 65, 40, 41, 42, 435, 435E, 44, 440E, 444, 445, 445E, 45, 450E, 455 RANCHER, 455E RANCHER, 460, 460 RANCHER, 50, 51, 55, T435; Jonsered: 2012, 2014, 2015, 2016, 2036, 2040, 2041, 2045, 2050, 051, 2054, 2055, 2063, 2141, 2145, 2147, 2149, 2150, 2152, 2153, 2155, 2156, 2159, 2163, 370, 380, 410, 420, 425, 435, 45, 450, 451, 451EVS, 452, 455, 490, 495P, 50, 51, 510, 52, 520, 521, 525, 535, 590, CS2149W, CS2152W; Makita: 45, DCS430, DCS43001, DCS43001, DCS431, DCS460, DCS4600S, DCS4630, DCS500, DCS5000, DCS5030, DCS5200; Oleo-Mac: 850, 938, 940, 941, 941C, 942, 945, 946, 947, 950, 950 Super, 950A, 951, 952, 956, 962, E300F, GS350, GS370, GS410CX; Partner: 1200EL, 1400EL, 1450EL, 1500EL, 1650EL, 365, 400, 405, 410, 450, 460, 465, 470, 495, 500, 510, 540, 545, P500, P5000, P5500

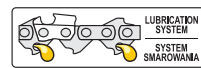
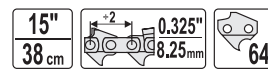

YATO	size / rozmiar	
YT-84945	15" (38 cm)	50



for / dla: Alpina: 270, 280, 330, 380, 432, 438, EURO-40, EURO-45, Elletra 160, Elletra 170, Energy 1.6, Energy 1.8, P360, P370, P390, PR350, Sinergy 35, Sinergy 40; Dolmar: CS2040, PS3300TH; Husqvarna: T425; McCulloch: 3500, 370, 374, 375, 384, 400, 400P, 430, 442, 445, 470, 474, 484, 838, 839, ELECTRA MAC 16E, MAC110, MAC120, MAC130, MAC140, MAC4, MAC6, MAC90, MAC935, MC115, MM30, MM36, PM310, PM320, PM330, PM340, PM36, PM360, PM364, PM370, PM380, PM394, PM400, M470, PM480, PM484, PM510, PM730; Oleo-Mac: 240, OEM200; Partner: 1535EL, 1540, 1540EL, 1640, 1835, 1840, 352, 371, 391, 538E, 542E, P1535, P351; Stihl: 009, 010, 011, 012, 017, 018, 019, 019T, 020, 020T, 021, 021C, 023, 025, 25, MS160, MS170, MS180, MS181, MS191, MS192, MS200, MS200T, MS210, MS211, MS230, MS231, MS241, MS250, MS251, MSE140, MSE200

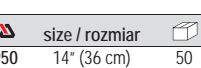
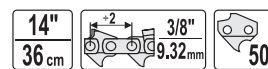

YATO	size / rozmiar	
YT-84950	14" (36 cm)	50



for / dla: YT-84931

for / dla: Al-Ko: 2000, 2300, 25A, E1200, E125, E1400, E1500, KE3500 VARIO, KE4000, KS, KSB; Alpina: 352, 382, A10E, A14E, E120, E130, E150, ELECTRIC, ES182, ES202, KS1400B, KS1500B; Dolmar: 100, 101, 102, 103, 104, 105, 106, 108, 275, 285, CS2040, ES140, ES151, ES152, ES152A, ES153, ES160, ES161, ES162, ES162A, ES163, ES172, ES172A, ES173, ES183, ES2035, ES2040, ES3, ES30, ES37, ES40, ES41, ES6, PS33, PS330, PS3300TH, PS330TH, PS34, PS340, PS341, PS3410, PS344, PS350, PS390, PS400, PS401, PS41, PS45; Echo: CS2600ES, CS260TES, CS2700ES, CS3500ES, CS3500ES, CS3500ES, CS3500ES, CS3500ES; Hitachi: CS280A, CS280B, CS350A, CS350B, CS35B; Homelite: 20AV, 23AV, 27, 3300, 3335, 3350, 3550, 3800, 4500, 4550, CS40, HCS3335, HCS4041CA, PS33, RANGER, TIMBERMAN, UT10901, UT10926, UT10974; Husqvarna: 136, 137, 1400, 141, 142, 16, 1600, 23, 243, 315, 316, 318, 320, 321, 33, 333, 334, 335XPT, 338, 338XPT, 36, 41, E16, E316, E317, E321, T425; Jonsered: 2033TH, 2035, 2115, 2115EL, 2116, 2117, 2118EL, 2121, 2135, 2137, 2138, 2139; Makita: 5012, 5016, BUC122RFE, BUC250RDE, DCS230T, DCS232T, DCS300, DCS300S, CS330, DCS330S, DCS34, DCS340, DCS341, DCS3410TH, DCS350, DCS3500, DCS3501, DCS3520A, DCS380, DCS390, DCS400, DCS401, DCS4610, UC3000, UC3030A, UC3500, UC3501, UC3520A, UC3530AK, UC4000, UC4030AK; McCulloch: MS1215, MS1415, MS1425, MS1435, MS1630, MS1635AV, MS1640, MS1645, MS1834N, MS1845J; Oleo-Mac: 931, 932, GS35, GS350, GS370; Partner: 330, 335, 340, 345, 350, 351, 360, 370, 385, 391, 395, P390, P420, P842; Ryobi: APR02, PCN33351

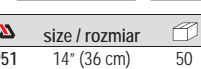
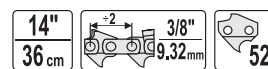

YATO	size / rozmiar	
YT-84951	14" (36 cm)	50



for / dla: YT-84935

for / dla: Al-Ko: 2000, 2300, 25A, E1200, E125, E1400, E1500, KE3500 VARIO, KE4000, KS, KSB; Alpina: 352, 382, A10E, A14E, E120, E130, E150, ELECTRIC, ES182, ES202, KS1400B, KS1500B; Dolmar: 100, 101, 102, 103, 104, 105, 106, 108, 275, 285, CS2040, ES140, ES151, ES152, ES152A, ES153, ES160, ES161, ES162, ES162A, ES163, ES172, ES172A, ES173, ES183, ES2035, ES2040, ES3, ES30, ES37, ES40, ES41, ES6, PS33, PS330, PS3300TH, PS330TH, PS34, PS340, PS341, PS3410, PS344, PS350, PS390, PS400, PS401, PS41, PS45; Echo: CS2600ES, CS260TES, CS2700ES, CS3500ES, CS3500ES, CS3500ES, CS3500ES, CS3500ES; Hitachi: CS280A, CS280B, CS350A, CS350B, CS35B; Homelite: 20AV, 23AV, 27, 3300, 3335, 3350, 3550, 3800, 4500, 4550, CS40, HCS3335, HCS4041CA, PS33, RANGER, TIMBERMAN, UT10901, UT10926, UT10974; Husqvarna: 136, 137, 1400, 141, 142, 16, 1600, 23, 243, 315, 316, 318, 320, 321, 33, 333, 334, 335XPT, 338, 338XPT, 36, 41, E16, E316, E317, E321, T425; Jonsered: 2033TH, 2035, 2115, 2115EL, 2116, 2117, 2118EL, 2121, 2135, 2137, 2138, 2139; Makita: 5012, 5016, BUC122RFE, BUC250RDE, DCS230T, DCS232T, DCS300, DCS300S, CS330, DCS330S, DCS34, DCS340, DCS341, DCS3410TH, DCS350, DCS3500, DCS3501, DCS3520A, DCS380, DCS390, DCS400, DCS401, DCS4610, UC3000, UC3030A, UC3500, UC3501, UC3520A, UC3530AK, UC4000, UC4030AK; McCulloch: MS1215, MS1415, MS1425, MS1435, MS1630, MS1635AV, MS1640, MS1645, MS1834N, MS1845J; Oleo-Mac: 931, 932, GS35, GS350, GS370; Partner: 330, 335, 340, 345, 350, 351, 360, 370, 385, 391, 395, P390, P420, P842; Ryobi: APR02, PCN3335

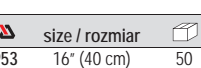
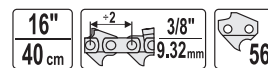

YATO	size / rozmiar	
YT-84953	16" (40 cm)	50

GB Chain for chainsaw
D Kette für Kettensägen
PL Łańcuch łańcuch do pił
RUS Цепь для бензопилы

CZ Řetěz pro řetězové pily
H Lānc lāncfűrész
RO Lant pt. drujba
F Chaîne de tronçonneuse

I Taglio per motosegna
E Cadena de motosierra
CN 蠟沫

COLOR BOX
WITH EURO HOLE



for / dla: YT-84935

for / dla: Al-Ko: 2000, 2300, 25A, E1200, E125, E1400, E1500, KE3500 VARIO, KE4000, KS, KSB; Alpina: 352, 382, A10E, A14E, E120, E130, E150, ELECTRIC, ES182, ES202, KS1400B, KS1500B; Dolmar: 100, 101, 102, 103, 104, 105, 106, 108, 275, 285, CS2040, ES140, ES151, ES152, ES152A, ES153, ES160, ES161, ES162, ES162A, ES163, ES172, ES172A, ES173, ES183, ES2035, ES2040, ES3, ES30, ES37, ES40, ES41, ES6, PS33, PS330, PS3300TH, PS330TH, PS34, PS340, PS341, PS3410, PS344, PS350, PS390, PS400, PS401, PS41, PS45; Echo: CS2600ES, CS260TES, CS2700ES, CS3500ES, CS3500WES, CS351WES; Hitachi: CS280A, CS280B, CS350A, CS350B, CS35B; Homelite: 20AV, 23AV, 27, 3300, 3335, 3350, 3500, 3800, 4500, 4550, CS40, HCS3335, HCS4041CA, PS33, RANGER, TIMBERMAN, UT10901, UT10926, UT10974; Husqvarna: 23, E16, E316, E317, E321, T425; Jonsered: 2033TH; Makita: 5012, 5016, BUC122RFE, BUC250RDE, DCS232T, DCS230T, DCS300, DCS300S, DCS330, DCS330S, DCS34, DCS340, DCS341, DCS3410TH, DCS350, DCS3500, DCS3501, DCS3520A, DCS380, DCS390, DCS400, DCS401, DCS4610, UC3000, UC3030A, UC3500, UC3501, UC3520A, UC3530AK, UC4000, UC4030AK; Oleo-Mac: 931, 932, GS35, GS350, GS370; Partner: 330, 335, 340, 345, 350, 351, 370, 385, 395, P390, P420; Ryobi: APR02, PCN3335

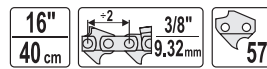

YATO	size / rozmiar	
YT-84954	16" (40 cm)	50

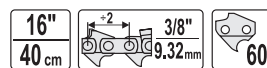

YATO	size / rozmiar	
YT-84955	16" (40 cm)	50

GB Chain for chainsaw
D Kette für Kettensägen
PL Łańcuch łańcuch do pił
RUS Цепь для бензопилы

CZ Řetěz pro řetězové pily
H Lānc lāncfűrész
RO Lant pt. drujba
F Chaîne de tronçonneuse

I Taglio per motosegna
E Cadena de motosierra
CN 蠟沫

PAPER SPOOL & COLOR LABEL
PLUS 30 PCS OF ADDITIONAL
COLOR BOXES & POLYBAGS



+30 PCS



for / dla: YT-84930, YT-84931, YT-84935

for / dla: Alpina: 270, 280, 330, 380, 432, 438, EURO-40, EURO-45, Elletra 160, Elletra 170, Energy 1.6, Energy 1.8, P360, P370, P390, PR350, Sinergy 35, Sinergy 40; Dolmar: CS2040, PS3300TH; Husqvarna: T425; McCulloch: 3500, 370, 374, 375, 384, 400, 400P, 430, 442, 445, 470, 474, 484, 838, 839, ELECTRA MAC 16E, MAC110, MAC120, MAC130, MAC140, MAC4, MAC6, MAC930, MAC935, MC115, MM30, MM36, PM310, PM320, PM330, PM340, PM36, PM360, PM364, PM370, PM380, PM394, PM400, M470, PM480, PM484, PM510, PM730; Oleo-Mac: 240, OEM200; Partner: 1535EL, 1540, 1540EL, 1640, 1835, 1840, 352, 371, 391, 538E, 542E, P1535, P351; Stihl: 009, 010, 011, 012, 017, 018, 019, 019T, 020, 020T, 021, 021C, 023, 025, 25, MS160, MS170, MS180, MS181, MS191, MS192, MS200, MS200T, MS210, MS211, MS230, MS231, MS241, MS250, MS251, MSE140, MSE200



YATO	size / rozmiar	
YT-84960	16" (40 cm)	1

for / dla: YT-84932

for / dla: Alpina: P700, P750, P800, PROF700, PROF800; Dolmar: 115, 117, 119, 120, 120SI, 122, 123, 1231, 133, 143, 152, 153, 186, 219, CA, KMS4, PS43, PS6000I, PS6000IH, PS6400, PS6400H, PS6800I, PS6800IH, PS7300, PS7300H, PS7900, PS7900H, PS9000, PS9000I; Echo: CS3500, CS3500WES, CS351WE; Husqvarna: 1100, 154, 160, 162, 181, 2100XP, 2101, 2101XP, 254, 257, 260, 261, 262, 266, 268, 272, 281XP, 285, 288XP, 298, 298X, 298XG, 3120, 3120XP, 357, 357XP, 359, 362, K34365, 371, 371XP, 371XPG, 372, 372XP, 372XPG, 380, 385, 385XP, 394, 394XP, 394XPG, 395, 395XP, 395XPG, 455, 480, 55, 560XP, 562XP, 570, 575, 575XP, 576XP, 61, 64, 65, 66, 70, 77; Jonsered: 1020, 2063, 2065, 2071, 2077, 2083, 2094, 2095, 2159, 2163, 2165, 2171, 2186, 625, 630, 630 SUPER, 670, 670 CHAMP, 820; Makita: DCS460, DCS4600, DCS500, DCS5030, DCS6400, DCS6401, DCS7301, DCS79001, DCS9000, DCS9010; Oleo-Mac: 250A, 251, 252, 254, 261, 264, 271, 272, 284, 350, 355, 460, 480, 481, 482, 484, 970, 971, 980, 981, E300; Partner: 550, 660, 710, P770

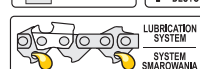

YATO	size / rozmiar	
YT-84961	16" (40 cm)	1

for / dla: YT-84905, YT-84933

for / dla: Dolmar: 109, 110, 111, 112, 113, 114, 115, 116, PS460, PS4600, S4605, PS500, PS5000, PS510, PS5100S, PS540; Husqvarna: 133, 136, 137, 141, 142, 154, 234, 238, 240, 242, 42XP, 246, 254, 254XP, 257, 261, 262, 338XPT, 339XP, 340, 345, 346, 346XP, 350, 351, 353, 357, 357XP, 359, 36, 65, 40, 41, 42, 435, 435E, 44, 440E, 444, 445, 445E, 45, 450E, 455 RANCHER, 455E RANCHER, 460, 460 RANCHER, 50, 51, 55, T435; Jonsered: 2012, 2014, 2015, 2016, 2036, 2040, 2041, 2045, 2050, 051, 2054, 2055, 2063, 2141, 2145, 2147, 2149, 2150, 2152, 2153, 2155, 2156, 2159, 2163, 370, 380, 410, 420, 425, 435, 45, 450, 451, 451EVS, 452, 455, 490, 495P, 50, 51, 510, 52, 520, 521, 525, 535, 590, CS2149W, CS2152W; Makita: 45, DCS430, DCS43001, DCS4300I, DCS431, DCS4310, DCS4600S, DCS4630, DCS500, DCS5000, DCS5030, DCS520, DCS5200I; Oleo-Mac: 850, 938, 940, 941, 941C, 942, 945, 946, 947, 950, 950 Super, 950A, 951, 952, 956, 962, E300F, GS350, GS370, GS410CX; Partner: 1200EL, 1400EL, 1450EL, 1500EL, 1650EL, 365, 400, 405, 410, 450, 460, 465, 470, 495, 500, 510, 540, 545, P500, P5000, P5500

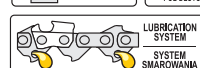

YATO	size / rozmiar	
YT-84962	16" (40 cm)	1

for / dla: YT-84900, YT-84934, YT-84936

for / dla: Dolmar: 109, 110, 111, 112, 113, 114, 115, 116, ES1800, PS460, PS4600, PS4605, PS500, PS5000, PS5510, PS5100S, PS540; Husqvarna: 154, 257, 440E, 133, 136, 137, 140, 141, 142, 234, 235, 238, 240, 240e, 242, 242XP, 246, 254, 254XP, 261, 262, 338XPT, 339XP, 340, 345, 346, 346XP, 350, 351, 353, 357, 357XP, 359, 36, 365, 372XP, 40, 41, 42, 435, 435E, 44, 444, 445, 445E, 45, 450E, 455 RANCHER, 455E RANCHER, 460 RANCHER, 50, 51, 55, T435; Jonsered: 520, 2012, 2014, 2015, 2016, 2036, 2040, 2041, 2045, 2050, 2051, 2054, 2055, 063, 2141, 2145, 2147, 2149, 2150, 2152, 2153, 2155, 2156, 2159, 2163, 370, 380, 410, 420, 425, 435, 45, 450, 451, 451EVS, 452, 455, 490, 495P, 50, 51, 510, 52, 521, 525, 535, 590, CS2149W, CS2152W; Makita: 45, DCS430, DCS43001, DCS4300I, DCS431, DCS460, DCS4600S, DCS4630, DCS500, DCS5000, DCS5030, DCS520, DCS5200I; NAC: NO-CS38, SPS01-45, SPS01-52, SPS02-45, YD 40/45, YD40, YD52; Oleo-Mac: 850, 938, 940, 941, 942, 945, 946, 947, 950, 950 Super, 950A, 951, 952, 956, 962, E300F; Partner: 1650, 365, 400, 405, 410, 450, 460, 465, 470, 495, 500, 510, 540, 545, P500, P5000, P5500

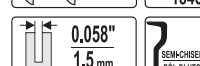

YATO	size / rozmiar	
YT-84963	16" (40 cm)	1

- GB Chainsaw chain spinner
- D Sägekette nietgerät
- PL Nitownica do łańcuchów do pilarek
- RUS Станок для клепания цепей
- CZ Nitovačka pilových řetězů
- H Szegecselő készülék fűrészláncához
- RO Masina de nituit lanturi si de spart lanturi
- F Riveteuse d'établi pour chaines de tronçonneuses
- I Catena spinner
- E Remachadora banco cadenas de motosierra
- CN 剿蠟

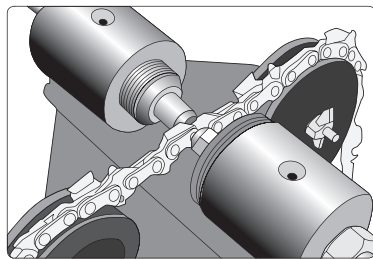
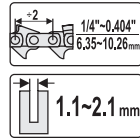

COLOR BOX



YATO	
YT-84970	6

- GB Chainsaw chain breaker
- D Sägeketten Entnietgerät
- PL Rozkuwarka do łańcuchów pilarek
- RUS Станок для расклепки цепей
- CZ Roznitovačka pilových řetězů
- H Szegecskinyomó fűrészláncához
- RO Masina spart lant drujba
- F Deriveteuse chaîne de tronçonneuse
- I Catena breaker
- E Rompe cadenas de motosierra
- CN 誘蠟

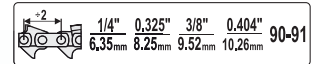

COLOR BOX



YATO	
YT-84971	6

- GB Electric hoist
- D Elektro-Seilwinde
- PL Elektryczny wciągnik linowy
- RUS Электрическая канатная лебедка
- CZ Elektrický naviják kladkostroj
- H Elektromos csőrő
- RO Troliu electric cu cablu
- F Treuil électrique à corde
- I Verricello elettrico
- E Cabría eléctrica de cuerdas
- CN 电动葫芦



COLOR BOX



500 W		
	125 kg	250 kg
YATO	W	
YT-5901	500	2
	8 m/min max. 11m	4 m/min max. 5.5m
	125 kg	250 kg

550 W		
	150 kg	300 kg
YATO	W	
YT-5902	550	2
	8 m/min max. 11m	4 m/min max. 5.5m
	150 kg	300 kg

900 W		
	250 kg	500 kg
YATO	W	
YT-5904	900	2
	8 m/min max. 11m	4 m/min max. 5.5m
	250 kg	500 kg

1050 W		
	300 kg	600 kg
YATO	W	
YT-5905	1050	2
	8 m/min max. 11m	4 m/min max. 5.5m
	300 kg	600 kg

19

Lock cylinders Wkładki do zamków



Lock cylinders
Wkładki do zamków

442



Brass lock cylinders

Wkładki mosiężne..... 442

Brass lock cylinders with knob

Wkładki mosiężne z gałką..... 442

- GB Lock cylinder
- D Schliesszylinder
- PL Wkładka do zamka
- RUS Замок цилиндрический
- CZ Vložka na zámek
- H Zárbetét
- RO Yală pt. broască
- F Serrure à encastrer
- I Cilindro con pomolo
- E Inserción de latón
- CN 锁芯

BRASS
MOSIADZ



Lock cylinder received „Test Certificate”
issued by Instytut Techniki Budowlanej

Wkładka posiada „Świadectwo Badań”
wystawione przez Instytut Techniki Budowlanej

COLOR BOX
& MESH
PLASTIC TRAY



YATO	L (mm)	mm	
YT-69900	62	31/31	12/60
YT-69901	67	31/36	12/60
YT-69902	72	31/41	12/60
YT-69903	87	36/51	12/60

- GB Lock cylinder
- D Schliesszylinder
- PL Wkładka do zamka
- RUS Замок цилиндрический
- CZ Vložka na zámek
- H Zárbetét
- RO Yală pt. broască
- F Serrure à encastrer
- I Cilindro con pomolo
- E Inserción de latón
- CN 锁芯

BRASS
MOSIADZ

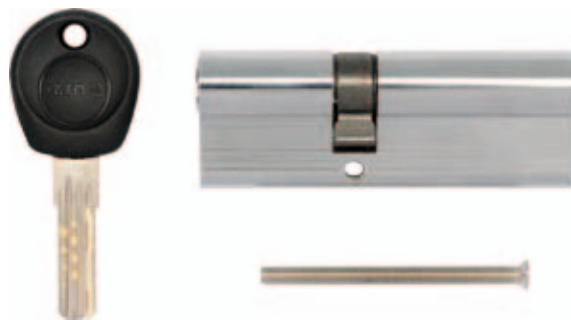

Lock cylinder received „Test Certificate”
issued by Instytut Techniki Budowlanej

Wkładka posiada „Świadectwo Badań”
wystawione przez Instytut Techniki Budowlanej

COLOR BOX
& MESH
PLASTIC TRAY



YATO	L (mm)	mm	
YT-69905	62	31/31	12/60
YT-69906	67	31/36	12/60
YT-69907	72	31/41	12/60
YT-69908	87	36/51	12/60

- GB Lock cylinder
- D Schliesszylinder
- PL Wkładka do zamka
- RUS Замок цилиндрический
- CZ Vložka na zámek
- H Zárbetét
- RO Yală pt. broască
- F Serrure à encastrer
- I Cilindro con pomolo
- E Inserción de latón
- CN 锁芯

BRASS
MOSIADZ



Lock cylinder received „Test Certificate”
issued by Instytut Techniki Budowlanej

Wkładka posiada „Świadectwo Badań”
wystawione przez Instytut Techniki Budowlanej

COLOR BOX
& MESH
PLASTIC TRAY



YATO	L (mm)	mm	
YT-69910	62	31/31	12/60
YT-69911	67	31/36	12/60
YT-69912	67	36/31	12/60
YT-69913	72	31/41	12/60
YT-69914	72	41/31	12/60

- GB Lock cylinder
- D Schliesszylinder
- PL Wkładka do zamka
- RUS Замок цилиндрический
- CZ Vložka na zámek
- H Zárbetét
- RO Yală pt. broască
- F Serrure à encastrer
- I Cilindro con pomolo
- E Inserción de latón
- CN 锁芯

BRASS
MOSIADZ

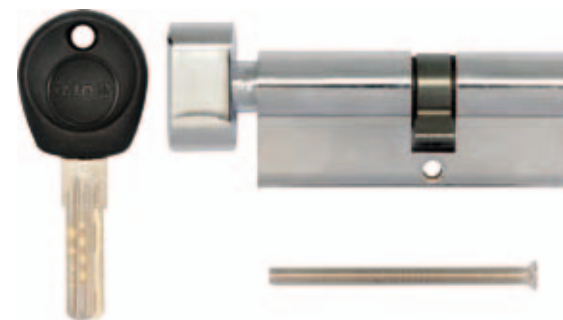

Lock cylinder received „Test Certificate”
issued by Instytut Techniki Budowlanej

Wkładka posiada „Świadectwo Badań”
wystawione przez Instytut Techniki Budowlanej

COLOR BOX
& MESH
PLASTIC TRAY



YATO	L (mm)	mm	
YT-69920	62	31/31	12/60
YT-69921	67	31/36	12/60
YT-69922	67	36/31	12/60
YT-69923	72	31/41	12/60
YT-69924	72	41/31	12/60

Memo



20

Accessories
Akcesoria



Tool belts
Pasy na narzędzia

446



Tool bags
Torby narzędziowe

447



Tool pockets
Kieszenie na narzędzia

446-447



- GB Heavy duty nail & tool pouch
- D Werkzeuggürtel mit Nägel- und Schraubentaschen
- PL Pas z kieszeniami na gwoździe i narzędzia
- RUS Ремень с сумками для гвоздей и инструментов
- CZ Pás na nářadí pětikapsový
- H Szeg és szerszámartató öv
- RO Centura port scule
- F Ceinture porte-outils clous
- I Cintura con le tasche per chiodi e utensili
- E Cinturón porta herramientas y accesorios varios
- CN 重型工具袋



21
POCKETS
KIESZENI

120
cm

HEAVY
DUTY
NYLON

COLOR BOX



COWHIDE BELT



YATO	
YT-7400	10

- GB Pouch belt
- D Gürtel für Werkzeugtaschen
- PL Pas na kieszenie na narzędzia
- RUS Пояс для карманов для инструмента
- CZ Opasek na monterské kapsáře
- H Öv erszényhez
- RO Cureau cu buzunar
- F Ceinture porte-outils
- I Cintura con le tasche porta utensili
- E Cinturón para bolsas de herramientas
- CN 工具腰带



HEADER
CARD



90-120
cm

HEAVY
DUTY
NYLON

YATO	
YT-7409	50/100

- GB 8-pocket tool bag
- D Gürtelwerkzeugtasche mit 8 Fächern
- PL 8. kieszeniowa torba na narzędzia
- RUS Сумка - 8 карманов для инструмента
- CZ Kapsář na nářadí 8-kapsový
- H Szerszámartató erszény, 8 zsebbel
- RO Geanta pt. scule 8 buzunare
- F Pochette à outils
- I Borsa porta attrezzi con 8 tasche
- E Bolso para herramientas de 8 bolsillos
- CN 工具包

HEADER
CARD



8
POCKETS
KIESZENI

HEAVY
DUTY
NYLON



YATO	
YT-7410	20/40

- GB Universal cordless drill holder
- D Gürteltasche für Akkuschauber
- PL Kieszeń na wiertarkę akumulatorową
- RUS Карман для аккумуляторной дрели
- CZ Kapsář za opasek na akuvrtáčku
- H Univerzális tartóerszény akkus csavabehajtóhoz

- RO Suport universal pt. bormasina
- F Pochette à perceuse sans fil
- I Fondina per trapano a batteria
- E Bolsa porta taladradora de acumulador
- CN 电钻通用挂袋

HEADER
CARD



HEAVY
DUTY
NYLON



YATO		YATO	
YT-7413	20/40	YT-7414	48/96

- GB Nail / tool pouch
- D Gürtelwerkzeugtasche
- PL Kieszeń na gwoździe i narzędzia
- RUS Карман для гвоздей и инструментов
- CZ Kapsář na nářadí
- H Szeg és szerszámartató erszény
- RO Buzunar pt. scule / cuie
- F Pochette à outils et clous
- I Tasche per chiodi e utensili
- E Bolsa porta herramientas y accesorios varios
- CN 钉子袋

HEADER
CARD



HEAVY
DUTY
NYLON



YATO		YATO	
YT-7416	20/40	YT-7417	39/156

- GB Nail pocket + hammer loop
D Hammer und Nägel-Gürteltasche
PL Kieszka z uchwytem na młotek
RUS Карман-держатель для молотка
CZ Kapsář za opasek na kladivo
H Szeg tartó erszény kalapáccstartóval
RO Suport pt. ciocan
F Pochette à outils + porte-marteau
I Tasca porta martello
E Bolsa con el soporte para martillo
CN 锤头钉子袋



HEAVY
DUTY
NYLON

HEADER
CARD



YT-7419



40/80

- GB Mobile phone pouch
D Handy-Gürteltasche
PL Kieszka na telefon komórkowy
RUS Карман для мобильного телефона
CZ Pouzdro za opasek na mobilni telefon
H Mobil telefon tartó
RO Suport pt. telefon
F Pochette à téléphone portable
I Tasca porta cellulare
E Bolsa de teléfono móvil
CN 手机袋



HEAVY
DUTY
NYLON

HEADER
CARD



YT-7420



27/54

- GB Tool bag
D Werkzeugtasche
PL Torba na narzędzia
RUS Сумка для инструмента
- CZ Taška montérská
H Szerszámos táská
RO Geanta pt. scule
F Sac à outils
- I Borsa per attrezzi
E Bolso de herramientas
CN 工具包

HEAVY
DUTY
NYLON



YT-7430



12



16
POCKETS
KIESZENI



YT-7433



12

- GB Steel tube tool carrier
D Werkzeugkoffer
PL Walizka narzędziowa
RUS Семодан для инструмента
CZ Taška na nářadí
H Szerszámtartó csövázás
RO Geanta de otel pt. portbagaj
F Sac à outils
I Valigetta per attrezzi
E Maletin de herramientas
CN 钢管柄工具包

31
POCKETS
KIESZENI

HEAVY
DUTY
NYLON



YT-7435



4

- GB Foldable chair with bag
D Werkzeugtasche mit Klappstuhl
PL Torba narzędziowa z krzeselkiem
RUS Стул складной с сумкой для инструмента
CZ Taška na nářadí se stojánkem
H Összecsukható szék tartózsebbel
RO Scaun rabatabil cu geanta
F Sac à outils + tabouret
I Sedia pieghevole per borsa attrezzi
E Bolso de herramientas con silla plegable
CN 带包折叠椅

22
POCKETS
KIESZENI

HEAVY
DUTY
NYLON



YT-7446



10

21

Health & safety articles
Artykuły BHP



Safety glasses
Okulary ochronne

450-451



Hearing protectors
Nauszniki przeciwhałasowe

455



Safety goggles
Gogle ochronne

451



Working shoes
Buty robocze

456-457



Working gloves
Rękawice robocze

452



Safety sandals

Sandały robocze..... 456

Low-cut safety shoes

Półbuty robocze..... 456

Middle-cut safety shoes

Trzewiki robocze..... 457

Knee pads
Nakolanniki

452



Working clothes

Odzież robocza

458-461



Disposable dust masks
Półmaski filtrujące

453-454



Vests

Kamizelki..... 458

Working jackets

Bluzy i kurtki robocze..... 458

Working trousers

Spodnie robocze..... 460

Working overalls

Spodnie robocze ogrodniczki i kombinezony..... 460

Ear plugs
Zatyczki do uszu

455



GB Safety glasses
D Schutzbrille
PL Okulary ochronne

RUS Очки защитные открытые
CZ Ochranné brýle
H Védőszemüveg

RO Ochelari pt. protectie
F Lunettes de protection
I Occhiali protettivi

E Gafas protectoras
CN 劳保眼镜

PAPER
HANGING
CARD





TYPE 90960 EN 166:2001 F

	
YT-7360	12/240



TYPE 9844 EN 166:2001 F

	
YT-7361	12/240



TYPE 91977 EN 166:2001 F

	
YT-7363	12/240



TYPE 91659 EN 166:2001 F

	
YT-7365	12/240





TYPE 91708 EN 166:2001 F

	
YT-7367	12/240



TYPE 91797 EN 166:2001 F

	
YT-7369	12/240



TYPE 91692 EN 166:2001 F

	
YT-7371	12/240





TYPE B524 EN 166:2001 F

	
YT-73631	12/300



TYPE B532 EN 166:2001 F

	
YT-73761	12/300



TYPE 9844 EN 166:2001 F

	
YT-7362	12/240



TYPE 91977 EN 166:2001 F

	
YT-7364	12/240



TYPE 91659 EN 166:2001 F

	
YT-7366	12/240





TYPE 91708 EN 166:2001 F

	
YT-7368	12/240





TYPE 91293 EN 166:2001 F

	
YT-7374	12/240





TYPE 91380 EN 166:2001 F

	
YT-7376	12/240





TYPE B517 EN 166:2001 F

	
YT-73641	12/300





TYPE B510 EN 166:2001 EN 169:2002

	
YT-73744	12/300



TYPE B532 EN 166:2001 F

	
YT-73760	12/300

GB Safety glasses
D Schutzbrille
PL Okulary ochronne

RUS Очки защитные открытые
CZ Ochranné brýle
H Védőszemüveg

RO Ochelari pt. protectie
F Lunettes de protection
I Occhiali protettivi

E Gafas protectoras
CN 劳保眼镜

POLYBAG WITH
HEADER



TYPE 92281 EN 166:2001 F

YATO 	
YT-73602	12/240





TYPE 92218SR EN 166:2001 F

YATO 	
YT-73700	12/240





TYPE 92281 EN 166:2001 F

YATO 	
YT-73603	12/240



TYPE 92218SR EN 166:2001 F

YATO 	
YT-73701	12/240

GB Safety goggles
D Schutzbrille
PL Gogle ochronne
RUS Очки защитные
CZ Ochranné brýle
H Védőszemüveg
RO Ochelari pt. protectie

F Lunettes masque
de protection
I Occhiali protettivi
a mascherina
E Gafas protectoras
CN 劳保眼镜

PAPER
HANGING
CARD





TYPE 2876 EN 166:2001 F

YATO 	
YT-7377	12/120



TYPE #2769 EN 166:2001 F

YATO 	
YT-7380	20/200





TYPE SG90B EN 166:2001 F

YATO 	
YT-7381	20/200





TYPE SG-60 EN 166:2001 B

YATO 	
YT-7382	10/100



TYPE TW2015 EN 166:2001 B

YATO 	
YT-7383	10/100



TYPE B608 EN 166:2001 B

YATO 	
YT-73801	10/100





TYPE B421 EN 166:2001 B



YATO 	
YT-73830	10/100

GB Working gloves
 D Arbeitshandschuh
 PL Rękawice robocze
 RUS Рабочие перчатки
 CZ Pracovní rukavice
 H Védőkesztyű
 RO Mănuși de lucru
 F Gants de travail
 I Guanti da lavoro
 E Guantes de piel
 CN 劳保手套





YATO 	size / rozmiar	
YT-7470	10	50/100





YATO 	size / rozmiar	
YT-7472	10	50/100





YATO 	size / rozmiar	
YT-7473	10	50/100





YATO 	size / rozmiar	
YT-7474	10	50/100



YATO 	size / rozmiar	
YT-7480	9	12/120
YT-7481	10	12/120



YATO 	size / rozmiar	
YT-7471	10	12/120

GB Gel knee pads
 D Gel Knieschoner
 PL Nakolanniki żelowe
 RUS Гелевые наколенники
 CZ Nákoleníky gelové
 H Térdvédő zselés
 RO Genunchiere
 cu protectie de silicon
 F Genouillères
 à coussinets de gel
 I Protettore per ginocchio
 E Protectores
 de gel para
 rodillas
 CN 护膝



YATO 	
YT-7460	12



YATO 	
YT-7461	12

GB Disposable dust masks
D Atemschutzmaske
PL Półmaski filtrujące jednorazowe
RUS Респиратор противопылевой одноразовый
CZ Protiprašná maska
H Eldobható porvédőmaszk
RO Masca prař
F Demi-masques de filtration
I Maschera filtra polvere
E Mascarilla desechable para protecci3n contra polvo
CN 防尘面罩

2
PCS

FFP1 NR



POLYBAG WITH HEADER



YATO 	
YT-74852	50

GB Disposable dust masks
D Atemschutzmaske
PL Półmaski filtrujące jednorazowe
RUS Респиратор противопылевой одноразовый
CZ Protiprašná maska
H Eldobható porvédőmaszk
RO Masca prař
F Demi-masques de filtration
I Maschera filtra polvere
E Mascarilla desechable para protecci3n contra polvo
CN 防尘面罩



3
PCS

FFP1 NR



POLYBAG WITH HEADER



YATO 	
YT-7485	25/100

GB Disposable dust mask with valve
D Atemschutzmaske mit Ventil
PL Półmaska filtrująca jednorazowa z zaworem
RUS Респиратор противопылевой одноразовый с клапаном
CZ Protiprašná maska s ventilem
H Eldobható porvédőmaszk, szelepes
RO Masca prař cu valva
F Demi-masques de filtration
I Maschera respiratoria con valvola di espirazione
E Mascarilla desechable para protecci3n contra polvo
CN 带阀防尘面罩

FFP1 NR



POLYBAG WITH HEADER



YATO 	
YT-74862	50

GB Disposable dust masks with valve
D Atemschutzmaske mit Ventil
PL Półmaski filtrujące jednorazowe z zaworem
RUS Респиратор противопылевой одноразовый с клапаном
CZ Protiprašná maska s ventilem
H Eldobható porvédőmaszk, szelepes
RO Masca prař cu valva
F Demi-masques de filtration
I Maschera respiratoria con valvola di espirazione
E Mascarilla desechable para protecci3n contra polvo
CN 带阀防尘面罩

3
PCS

FFP1 NR



POLYBAG WITH HEADER



YATO 	
YT-7486	25/100

GB Disposable dust masks
D Atemschutzmaske
PL Półmaski filtrujące jednorazowe
RUS Респиратор противопылевой одноразовый
CZ Protiprašná maska
H Eldobható porvédőmaszk
RO Masca prař
F Demi-masques de filtration
I Maschera filtra polvere
E Mascarilla desechable para protecci3n contra polvo
CN 防尘面罩

3
PCS

FFP1 NR



POLYBAG WITH HEADER



YATO 	
YT-74870	50

GB Disposable dust masks with valve
D Atemschutzmaske mit Ventil
PL Półmaski filtrujące jednorazowe z zaworem
RUS Респиратор противопылевой одноразовый с клапаном
CZ Protiprašná maska s ventilem
H Eldobható porvédőmaszk, szelepes
RO Masca prař cu valva
F Demi-masques de filtration
I Maschera respiratoria con valvola di espirazione
E Mascarilla desechable para protecci3n contra polvo
CN 带阀防尘面罩

3
PCS

FFP1 NR



POLYBAG WITH HEADER



YATO 	
YT-7488	25/100

GB Disposable dust masks
 D Atemschutzmaske
 PL Półmaski filtrujące jednorazowe
 RUS Респиратор противопылевой одноразовый
 CZ Protiprašná maska
 H Eldobható porvédőmaszk
 RO Masca praaf
 F Demi-masques de filtration
 I Maschera filtra polvere
 E Mascarilla desechable para protección contra polvo
 CN 防尘面罩

3
 PCS
 FFP2 NR



POLYBAG WITH HEADER

YATO
 YT-74916 50

GB Disposable dust masks with valve
 D Atemschutzmaske mit Ventil
 PL Półmaski filtrujące jednorazowe z zaworem
 RUS Респиратор противопылевой одноразовый с клапаном
 CZ Protiprašná maska s ventilem
 H Eldobható porvédőmaszk, szelepes
 RO Masca praaf cu valva
 F Demi-masques de filtration
 I Maschera respiratoria con valvola di espirazione
 E Mascarilla desechable para protección contra polvo
 CN 带阀防尘面罩

3
 PCS
 FFP2 NR



POLYBAG WITH HEADER

YATO
 YT-74917 50

GB Disposable dust masks with valve
 D Atemschutzmaske mit Ventil
 PL Półmaski filtrujące jednorazowe z zaworem
 RUS Респиратор противопылевой одноразовый с клапаном
 CZ Protiprašná maska s ventilem
 H Eldobható porvédőmaszk, szelepes
 RO Masca praaf cu valva
 F Demi-masques de filtration
 I Maschera respiratoria con valvola di espirazione
 E Mascarilla desechable para protección contra polvo
 CN 带阀防尘面罩

3
 PCS
 FFP2 NR



POLYBAG WITH HEADER

YATO
 YT-7492 15/60

GB Disposable dust masks
 D Atemschutzmaske
 PL Półmaski filtrujące jednorazowe
 RUS Респиратор противопылевой одноразовый
 CZ Protiprašná maska
 H Eldobható porvédőmaszk
 RO Masca praaf
 F Demi-masques de filtration
 I Maschera filtra polvere
 E Mascarilla desechable para protección contra polvo
 CN 防尘面罩

2
 PCS
 FFP2 NR



POLYBAG WITH HEADER

YATO
 YT-74919 50

GB Disposable dust mask with valve
 D Atemschutzmaske mit Ventil
 PL Półmaska filtrująca jednorazowa z zaworem
 RUS Респиратор противопылевой одноразовый с клапаном
 CZ Protiprašná maska s ventilem
 H Eldobható porvédőmaszk, szelepes
 RO Masca praaf cu valva
 F Demi-masques de filtration
 I Maschera respiratoria con valvola di espirazione
 E Mascarilla desechable para protección contra polvo
 CN 带阀防尘面罩

FFP2 NR



POLYBAG WITH HEADER

YATO
 YT-74949 50

GB Ear plugs
D Gehörschutz
PL Zatycki do uszu

RUS Средства защиты слуха
CZ Chráníče sluchu
H Fülvédőt

RO Antifoane
F Bouchons anti-bruit
I Tappi per orecchie

E Tapones para los oídos
CN 耳塞

SNR
34 dB

5
PAIRS
PAR



POLYBAG
WITH HEADER

SNR
28 dB

5
PAIRS
PAR



POLYBAG
WITH HEADER

SNR
22 dB

5
PAIRS
PAR



POLYBAG
WITH HEADER

YATO	size / rozmiar (mm)	pairs / pary	
YT-7451	7-12	5	25/500

YATO	size / rozmiar (mm)	pairs / pary	
YT-7453	8-13	5	25/500

YATO	size / rozmiar (mm)	pairs / pary	
YT-7455	8-12	5	25/500

SNR
22 dB

50
PAIRS
PAR



50 PCS

WHITE CARTON BOX
& COLOR LABEL



SNR
34 dB

200
PAIRS
PAR



200 PCS

DISPLAY
COLOR BOX



SNR
28 dB



50 PCS

WHITE CARTON BOX
& COLOR LABEL



YATO	size / rozmiar (mm)	pairs / pary	
YT-7454	8-12	50	20

YATO	size / rozmiar (mm)	pairs / pary	
YT-74510	7-12	200	20

YATO	size / rozmiar (mm)	pairs / pary	
YT-7456	8-10	50	20

GB Ear plugs
D Gehörschutz
PL Zatycki do uszu na pałąku
RUS Средства защиты слуха
CZ Chráníče sluchu
H Fülvédőt
RO Antifoane
F Arceau antibruit
avec bouchons
I Tappi per orecchie
auricolari
E Tapones para
los oídos
CN 耳塞



SNR
21 dB

YATO	
YT-7458	25/500



POLYBAG
WITH
HEADER



SNR
26 dB

YATO	
YT-7459	25/500

GB Hearing protectors
D Gehörschutz
PL Nauszniki przeciwhałasowe
RUS Средства защиты слуха
CZ Chráníče sluchu
H Fülvédőt

RO Antifoane
F Casque anti-bruit
I Cuffie antirumore
E Protectores auditivos
CN 耳罩

POLYBAG
WITH
HEADER



SNR
26 dB

YATO	
YT-7462	40



SNR
26 dB

YATO	
YT-7463	20



SNR
27 dB

YATO	
YT-74621	60

GB Safety sandals
D Arbeitshalschuhe
PL Sandały robocze
RUS Полуботинки рабочие

CZ Pracovní polobotky
H Munkavédelmi félcipő
RO Papuc de lucru
F Sandale de sécurité

I Sandalo da lavoro
E Zapato de trabajo
CN 劳保鞋

RED CARTON BOX
& COLOR LABEL



SEGURA

INSOLE & MESH
COATED EVA
WKŁADKA
I WYŚCİÓŁKA
Z MATERIAŁU
EVA



COMPOSITE
TOE CUP
KOMPOZYTOWY
NOSEK



SHOCK ABSORBER
AMORTYZATOR
DRGAŃ

PU OVERCUP
PODESZWA
Z POLIURETANU
Z NOSKIEM

YATO	size / rozmiar	
YT-80460	36	10
YT-80461	37	10
YT-80462	38	10
YT-80463	39	10
YT-80464	40	10
YT-80465	41	10
YT-80466	42	10
YT-80467	43	10
YT-80468	44	10
YT-80469	45	10
YT-80470	46	10
YT-80471	47	10

GB Low-cut safety shoes
D Arbeitshalschuhe
PL Półbuty robocze
RUS Полуботинки рабочие

CZ Pracovní polobotky
H Munkavédelmi félcipő
RO Papuc de lucru
F Chaussure de sécurité

I Scarpe da lavoro
E Zapato de trabajo
CN 劳保鞋

RED CARTON BOX
& COLOR LABEL

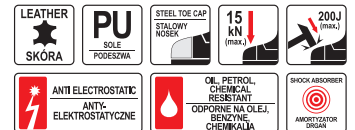

PUNO

INSOLE & MESH
COATED EVA
WKŁADKA
I WYŚCİÓŁKA
Z MATERIAŁU
EVA



STALOWY NOSEK
STEEL TOE CAP
PU SOLE
PODESZWA
Z POLIURETANU



SHOCK ABSORBER
AMORTYZATOR
DRGAŃ



INSOLE & MESH
COATED EVA
WKŁADKA
I WYŚCİÓŁKA
Z MATERIAŁU
EVA



STALOWY NOSEK
STEEL TOE CAP
PU SOLE
PODESZWA
Z POLIURETANU



SHOCK ABSORBER
AMORTYZATOR
DRGAŃ



YATO	size / rozmiar	
YT-80521	39	10
YT-80522	40	10
YT-80523	41	10
YT-80524	42	10
YT-80525	43	10
YT-80526	44	10
YT-80527	45	10
YT-80528	46	10
YT-80529	47	10

YATO	size / rozmiar	
YT-80572	39	10
YT-80573	40	10
YT-80574	41	10
YT-80575	42	10
YT-80576	43	10
YT-80577	44	10
YT-80578	45	10
YT-80579	46	10
YT-80580	47	10

INSOLE & MESH
COATED EVA
WKŁADKA
I WYŚCİÓŁKA
Z MATERIAŁU
EVA



STALOWY NOSEK
STEEL TOE CAP
PU SOLE
PODESZWA
Z POLIURETANU



SHOCK ABSORBER
AMORTYZATOR
DRGAŃ



INSOLE & MESH
COATED EVA
WKŁADKA
I WYŚCİÓŁKA
Z MATERIAŁU
EVA



STALOWY NOSEK
STEEL TOE CAP
PU SOLE
PODESZWA
Z POLIURETANU



SHOCK ABSORBER
AMORTYZATOR
DRGAŃ

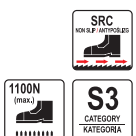

YATO	size / rozmiar	
YT-80552	39	10
YT-80553	40	10
YT-80554	41	10
YT-80555	42	10
YT-80556	43	10
YT-80557	44	10
YT-80558	45	10
YT-80559	46	10
YT-80560	47	10

YATO	size / rozmiar	
YT-80583	39	10
YT-80584	40	10
YT-80585	41	10
YT-80586	42	10
YT-80587	43	10
YT-80588	44	10
YT-80589	45	10
YT-80590	46	10
YT-80591	47	10

GB Middle-cut safety shoes
D Arbeitsschnürschuhe
PL Trzewiki robocze
RUS Ботинки рабочие

CZ Pracovní boty šněrovací
H Munkavédelmi bakancs
RO Pantof de lucru
F Chaussure de sécurité

I Scarpe da lavoro
E Calzado de trabajo
CN 劳保鞋

RED CARTON BOX
& COLOR LABEL



INSOLE & MESH
COATED EVA
WKŁADKA
I WYSIÓŁKA
Z MATERIAŁU
EVA



TRAT

INSOLE & MESH
COATED EVA
WKŁADKA
I WYSIÓŁKA
Z MATERIAŁU
EVA



TABAR



SHOCK ABSORBER
AMORTYZATOR
DRGAŃ

STEEL TOE CAP
STALOWY NOSEK

PU SOLE
PODESZWA
Z POLIURETANU



SHOCK ABSORBER
AMORTYZATOR
DRGAŃ

STEEL TOE CAP
STALOWY NOSEK

PU SOLE
PODESZWA
Z POLIURETANU



YATO	size / rozmiar	
YT-80733	39	10
YT-80734	40	10
YT-80735	41	10
YT-80736	42	10
YT-80737	43	10
YT-80738	44	10
YT-80739	45	10
YT-80740	46	10
YT-80741	47	10

YATO	size / rozmiar	
YT-80761	39	10
YT-80762	40	10
YT-80763	41	10
YT-80764	42	10
YT-80765	43	10
YT-80766	44	10
YT-80767	45	10
YT-80768	46	10
YT-80769	47	10

INSOLE & MESH
COATED EVA
WKŁADKA
I WYSIÓŁKA
Z MATERIAŁU
EVA



TENDA

STEEL TOE CAP
STALOWY NOSEK

PU OVERCUP
PODESZWA
Z POLIURETANU
Z NOSKIEM

PU SOLE
PODESZWA
Z POLIURETANU



SHOCK ABSORBER
AMORTYZATOR
DRGAŃ

INSOLE & MESH
COATED EVA
WKŁADKA
I WYSIÓŁKA
Z MATERIAŁU
EVA



TEZU

STEEL TOE CAP
STALOWY NOSEK

PU SOLE
PODESZWA
Z POLIURETANU



SHOCK ABSORBER
AMORTYZATOR
DRGAŃ

YATO	size / rozmiar	
YT-80852	39	10
YT-80853	40	10
YT-80854	41	10
YT-80855	42	10
YT-80856	43	10
YT-80857	44	10
YT-80858	45	10
YT-80859	46	10
YT-80860	47	10

YATO	size / rozmiar	
YT-80841	39	10
YT-80842	40	10
YT-80843	41	10
YT-80844	42	10
YT-80845	43	10
YT-80846	44	10
YT-80847	45	10
YT-80848	46	10
YT-80849	47	10

INSOLE & MESH
COATED EVA
WKŁADKA
I WYSIÓŁKA
Z MATERIAŁU
EVA



TOLU

STEEL TOE CAP
STALOWY NOSEK

PU SOLE
PODESZWA
Z POLIURETANU



SHOCK ABSORBER
AMORTYZATOR
DRGAŃ

INSOLE & MESH
COATED EVA
WKŁADKA
I WYSIÓŁKA
Z MATERIAŁU
EVA



TWER

STEEL TOE CAP
STALOWY NOSEK

PU SOLE
PODESZWA
Z POLIURETANU



SHOCK ABSORBER
AMORTYZATOR
DRGAŃ

YATO	size / rozmiar	
YT-80794	39	10
YT-80795	40	10
YT-80796	41	10
YT-80797	42	10
YT-80798	43	10
YT-80799	44	10
YT-80800	45	10
YT-80801	46	10
YT-80802	47	10

YATO	size / rozmiar	
YT-80783	39	10
YT-80784	40	10
YT-80785	41	10
YT-80786	42	10
YT-80787	43	10
YT-80788	44	10
YT-80789	45	10
YT-80790	46	10
YT-80791	47	10

GB Insulated vest CZ Vesta I Gilet imbottito
 D Gepolsterte Weste H Bélelt mellény E Chaleco acolchado
 PL Bezrękawnik ocieplany RO Vestă vătuită CN 绝缘背心
 RUS Утепленный жилет F Gilet matelassé



100% POLYESTER
 PVC COATED
 100% POLYESTER
 POWŁOKA PVC



POLYBAG



DUGO

YATO 	size / rozmiar	
YT-80355	S	20
YT-80356	M	20
YT-80357	L	20
YT-80358	XL	20
YT-80359	XXL	20

GB Fleece jacket CZ Fleecová bunda I Giacca in pile
 D Fleece-Jacke H Fleece dzseki E Chaqueta polar
 PL Bluza polarowa RO Bluza polar CN 摇粒绒夹克
 RUS Флисовая кофта F Veste polaire



POLAR
 350g/m²



POLYBAG



DURANGO BLACK

YATO 	size / rozmiar	
YT-80360	S	8
YT-80361	M	8
YT-80362	L	12
YT-80363	XL	12
YT-80364	XXL	12

GB Fleece jacket CZ Fleecová bunda I Giacca in pile
 D Fleece-Jacke H Fleece dzseki E Chaqueta polar
 PL Bluza polarowa RO Bluza polar CN 摇粒绒夹克
 RUS Флисовая кофта F Veste polaire



POLAR
 350g/m²



POLYBAG



DURANGO GREY

YATO 	size / rozmiar	
YT-80365	S	8
YT-80366	M	8
YT-80367	L	8
YT-80368	XL	8
YT-80369	XXL	8

GB Softshell jacket CZ Softshellová bunda I Giacca softshell
 D Softshell-Jacke H Softshell dzseki E Chaqueta softshell
 PL Kurtka softshell RO Jacheta softshell CN 冲锋夹克
 RUS Softshell куртка F Veste softshell



96% POLYESTER
 4% SPANDEX
 96% POLYESTER
 4% SPANDEX



POLYBAG



DEZ

YATO 	size / rozmiar	
YT-80390	S	10
YT-80391	M	10
YT-80392	L	10
YT-80393	XL	10
YT-80394	XXL	10

GB Working jacket
D Arbeitsjacke
PL Bluza robocza
RUS Рабочая рубашка

CZ Pracovní blůza
H Munkaruha felső
RO Bluză de lucru
F Blouson de travail

I Felpa da lavoro
E Blusa de trabajo
CN 工作服

65% POLYESTER
35% COTTON
65% POLYESTER
35% BAWELNA

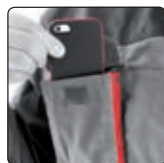

POLYBAG
WITH PLASTIC
HANGER



DAN

YATO	size / rozmiar	
YT-80280	S	10
YT-80281	M	10
YT-80282	L	10
YT-80283	XL	10
YT-80284	XXL	10

GB Working jacket
D Arbeitsjacke
PL Bluza robocza
RUS Рабочая рубашка

CZ Pracovní blůza
H Munkaruha felső
RO Bluză de lucru
F Blouson de travail

I Felpa da lavoro
E Blusa de trabajo
CN 工作服

65% POLYESTER
35% COTTON
65% POLYESTER
35% BAWELNA



POLYBAG
WITH PLASTIC
HANGER



DOHAR

YATO	size / rozmiar	
YT-80435	S	20
YT-80436	M	20
YT-80437	L	20
YT-80438	XL	20
YT-80439	XXL	20

GB Jacket
D Jacke
PL Kurtka
RUS Куртка

CZ Bunda
H Dzségi
RO Jacheta
F Veste

I Giacca
E Chaqueta
CN 夹克

100% POLYESTER
PVC COATED
100% POLYESTER
POWLODKA PVC

POLAR
220 g/m²
3in1
3w1

GB Working jacket
D Arbeitsjacke
PL Bluză robocza
RUS Рабочая рубашка

CZ Pracovní blůza
H Munkaruha felső
RO Bluză de lucru
F Blouson de travail

I Felpa da lavoro
E Blusa de trabajo
CN 工作服

65% POLYESTER
35% COTTON
65% POLYESTER
35% BAWELNA



POLYBAG



DORRA

YATO	size / rozmiar	
YT-80380	S	10
YT-80381	M	10
YT-80382	L	10
YT-80383	XL	10
YT-80384	XXL	10



POLYBAG



DUERO

YATO	size / rozmiar	
YT-8020	S	20
YT-8021	M	20
YT-8022	L	20
YT-8023	XL	20
YT-8024	XXL	20

GB Working trousers
D Arbeitshosen
PL Spodnie robocze
RUS Рабочие брюки

CZ Pracovní kalhoty
H Munkaruha nadrág
RO Pantaloni de lucru
F Pantalon de travail

I Pantalone da lavoro
E Pantalón de trabajo
CN 工作服



65% POLYESTER
35% COTTON
65% POLYESTER
35% BAWELNA



POLYBAG



DUERO

YATO 	size / rozmiar	
YT-8025	S	20
YT-8026	M	20
YT-8027	L	20
YT-8028	XL	20
YT-8029	XXL	20

GB Working trousers
D Arbeitshosen
PL Spodnie robocze
RUS Рабочие брюки

CZ Pracovní kalhoty
H Munkaruha nadrág
RO Pantaloni de lucru
F Pantalon de travail

I Pantalone da lavoro
E Pantalón de trabajo
CN 工作服



65% POLYESTER
35% COTTON
65% POLYESTER
35% BAWELNA



POLYBAG
WITH PLASTIC
HANGER



DAN

YATO 	size / rozmiar	
YT-80285	S	10
YT-80286	M	10
YT-80287	L	10
YT-80288	XL	10
YT-80289	XXL	10

GB Working trousers
D Arbeitshosen
PL Spodnie robocze
RUS Рабочие брюки

CZ Pracovní kalhoty
H Munkaruha nadrág
RO Pantaloni de lucru
F Pantalon de travail

I Pantalone da lavoro
E Pantalón de trabajo
CN 工作服

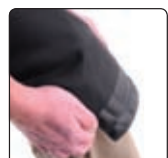

65% POLYESTER
35% COTTON
65% POLYESTER
35% BAWELNA



POLYBAG
WITH PLASTIC
HANGER



DOHAR

YATO 	size / rozmiar	
YT-80440	S	20
YT-80441	M	20
YT-80442	L	20
YT-80443	XL	20
YT-80444	XXL	20

GB Working overalls
D Arbeitshosen, Gärtnerin
PL Spodnie robocze ogrodniczkizki
RUS Рабочий полукombineзон
CZ Pracovní kalhoty lačlové
H Kertész nadrág

RO Pantaloni de lucru grădinară
F Salopette de travail
I Salopette da lavoro
E Pantalón de trabajo tipo jardinero
CN 工作服



65% POLYESTER
35% COTTON
65% POLYESTER
35% BAWELNA



POLYBAG



DUERO

YATO 	size / rozmiar	
YT-8030	S	20
YT-8031	M	20
YT-8032	L	20
YT-8033	XL	20
YT-8034	XXL	20

GB Working overalls
D Arbeitshosen, Gärtnerin
PL Spodnie robocze ogrodniczk
RUS Рабочий полукомбинезон
CZ Pracovní kalhoty lačlové
H Kertész nadrág

RO Pantaloni de lucru grădină
F Salopette de travail
I Salopette da lavoro
E Pantalón de trabajo tipo jardinero
CN 工作服



65% POLYESTER
35% COTTON
65% POLYESTER
35% BAWEŁNA



POLYBAG
WITH PLASTIC
HANGER



DAN

YATO 	size / rozmiar	
YT-80290	S	10
YT-80291	M	10
YT-80292	L	10
YT-80293	XL	10
YT-80294	XXL	10

GB Working overalls
D Arbeitshosen, Gärtnerin
PL Spodnie robocze ogrodniczk
RUS Рабочий полукомбинезон
CZ Pracovní kalhoty lačlové
H Kertész nadrág

RO Pantaloni de lucru grădină
F Salopette de travail
I Salopette da lavoro
E Pantalón de trabajo tipo jardinero
CN 工作服



65% POLYESTER
35% COTTON
65% POLYESTER
35% BAWEŁNA



POLYBAG
WITH PLASTIC
HANGER



DOHAR

YATO 	size / rozmiar	
YT-80445	S	20
YT-80446	M	20
YT-80447	L	20
YT-80448	XL	20
YT-80449	XXL	20

GB Work overall
D Arbeitsoverall
PL Kombinezon roboczy
RUS Комбинезон рабочий

CZ Pracovní kombinéza
H Munka overall
RO Salopete de lucru
F Combinaison

I Tuta de lavoro
E Mono de trabajo
CN 连体工作服

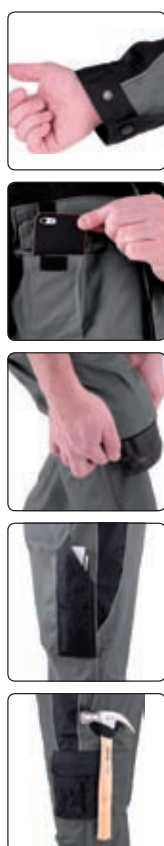

65% POLYESTER
35% COTTON
65% POLYESTER
35% BAWEŁNA



POLYBAG
WITH PLASTIC
HANGER



DOHAR

YATO 	size / rozmiar	
YT-80420	S	15
YT-80421	M	15
YT-80422	L	15
YT-80423	XL	15
YT-80424	XXL	15

GB Work overall
D Arbeitsoverall
PL Kombinezon roboczy
RUS Комбинезон рабочий

CZ Pracovní kombinéza
H Munka overall
RO Salopete de lucru
F Combinaison

I Tuta de lavoro
E Mono de trabajo
CN 连体工作服

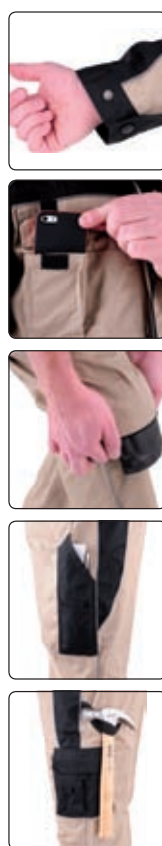

65% POLYESTER
35% COTTON
65% POLYESTER
35% BAWEŁNA



POLYBAG
WITH PLASTIC
HANGER



DOHAR

YATO 	size / rozmiar	
YT-80430	S	20
YT-80431	M	20
YT-80432	L	20
YT-80433	XL	20
YT-80434	XXL	20

22

Electric products Artykuły elektryczne



Ceiling & wall lamps
Oprawy sufitowe i ścienne

464-465



Workshop lightning
Oświetlenie warsztatowe

469-472



Floodlights
Naświetlacze

466-468



Flashlights
Latarki

473



Solar lamps
Oprawy solarne

468



Extension cords
Przedłużacze elektryczne

474-475



- GB LED ceiling light
- D LED-deckenleuchte
- PL Oprawa sufitowa LED
- RUS Потолочный светодиодный светильник
- CZ Stropní LED svítidlo
- H Mennyezeti LED lámpatest
- RO Corp de iluminat pt. tavan LED
- F Lumiere de plafond a LED
- I Plafoniera LED
- E Luz de techo del LED
- CN LED 吸顶灯

GREY CARTON BOX
& COLOR LABEL



230V~
50Hz

4000K

120°

50000 h

IP20



18W 80 LED 1150 lm

40W 112 LED 3100 lm

40W 112 LED 3000 lm

YATO	W	lm	size / rozmiar (mm)	
YT-81941	18	1150	300 x 300 x 15	10

YATO	W	lm	size / rozmiar (mm)	
YT-81943	40	3100	595 x 595 x 15	5

YATO	W	lm	size / rozmiar (mm)	
YT-81947	40	3000	300 x 1200 x 15	4

- GB Wall lamp
- D Wandleuchte
- PL Lampa naścienna
- RUS Светильник настенный
- CZ Nástěnné svítidlo
- H Fali lámpa
- RO Lampă de perete
- F Applique
- I Lampada da parete
- E Lámpara de pared
- CN 壁灯

COLOR BOX



15W

230V~
50Hz

850 lm

4000K

120°

IP54



OUTDOOR LAMP
LAMPĂ ZEWNĘTRZNA

OUTDOOR LAMP
LAMPĂ ZEWNĘTRZNA

YATO	W	lm	size / rozmiar (mm)	
YT-81840	15	850	260	12

YATO	W	lm	size / rozmiar (mm)	
YT-81841	15	850	260	12

- GB Wall lamp
- D Wandleuchte
- PL Lampa naścienna
- RUS Светильник настенный
- CZ Nástěnné svítidlo
- H Fali lámpa
- RO Lampă de perete
- F Applique
- I Lampada da parete
- E Lámpara de pared
- CN 壁灯



COLOR BOX



15W	230V~ 50Hz	850 lm	4000 K	120°	IP54
-----	---------------	-----------	--------	------	------





OUTDOOR LAMP
LAMPĂ ZEWNĘTRZNA

YATO 	W	lm	size / rozmiar (mm)	
YT-81842	15	850	285 x 170	12



OUTDOOR LAMP
LAMPĂ ZEWNĘTRZNA

YATO 	W	lm	size / rozmiar (mm)	
YT-81843	15	850	285 x 170	12

- GB Wall lamp
- D Wandleuchte
- PL Lampa naścienna
- RUS Светильник настенный
- CZ Nástěnné svítidlo
- H Fali lámpa
- RO Lampă de perete
- F Applique
- I Lampada da parete
- E Lámpara de pared
- CN 壁灯



COLOR BOX



230V~ 50Hz	4000 K	120°	20000 h	IP54
---------------	--------	------	---------	------





8W	650 lm	 55 W REPLACEMENT ODPOWIEDNIK
----	-----------	--

YATO 	W	lm	size / rozmiar (mm)	
YT-81834	8	650	165 x 115	24



12W	860 lm	 70 W REPLACEMENT ODPOWIEDNIK
-----	-----------	--

YATO 	W	lm	size / rozmiar (mm)	
YT-81835	12	860	222 x 143	24

GB LED lamp
D Diodenscheinwerfer
PL Reflektor diodowy
RUS Светодиодный прожектор
CZ LED reflektor
H Diódás reflektor
RO Reflector diodă
F Projecteur LED
I Faretto LED
E Reflector de diodos
CN 工作灯

10W 700lm 6000K 230V~50Hz
20000h IP65

COB LED

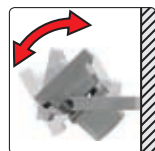

YATO
YT-81800 18

GB LED lamp
D Diodenscheinwerfer
PL Reflektor diodowy
RUS Светодиодный прожектор
CZ LED reflektor
H Diódás reflektor
RO Reflector diodă
F Projecteur LED
I Faretto LED
E Reflector de diodos
CN 工作灯

20W 1400lm 6000K 230V~50Hz
20000h IP65

COB LED

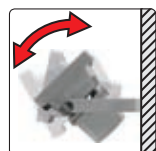

YATO
YT-81797 16

GB LED lamp
D Diodenscheinwerfer
PL Reflektor diodowy
RUS Светодиодный прожектор
CZ LED reflektor
H Diódás reflektor
RO Reflector diodă
F Projecteur LED
I Faretto LED
E Reflector de diodos
CN 工作灯

30W 2100lm 6000K 230V~50Hz
20000h IP65

COB LED

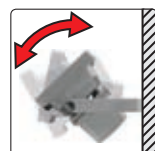

YATO
YT-81803 6

GB LED lamp
D Diodenscheinwerfer
PL Reflektor diodowy
RUS Светодиодный прожектор
CZ LED reflektor
H Diódás reflektor
RO Reflector diodă
F Projecteur LED
I Faretto LED
E Reflector de diodos
CN 工作灯

50W 3500lm 6000K 230V~50Hz
20000h IP65

COB LED

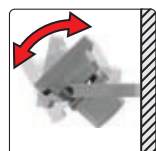

YATO
YT-81806 3

GB LED lamp with motion detector
D Diodenscheinwerfer mit Bewegungsmelder
PL Reflektor diodowy z czujnikiem ruchu
RUS Светодиодный прожектор с датчиком движения
CZ LED reflektor se snímačem pohybu
H Diódás reflektor mozgásérzékelővel
RO Reflector diodă cu senzor de mișcare
F Projecteur LED avec détecteur de mouvement
I Faretto LED con sensore movimento
E Reflector de diodos con sensor de movimiento
CN 感应灯

10W 700lm 6000K 230V~50Hz
12m 20000h IP44

COB LED



YATO
YT-81801 18

GB LED lamp with motion detector
D Diodenscheinwerfer mit Bewegungsmelder
PL Reflektor diodowy z czujnikiem ruchu
RUS Светодиодный прожектор с датчиком движения
CZ LED reflektor se snímačem pohybu
H Diódás reflektor mozgásérzékelővel
RO Reflector diodă cu senzor de mișcare
F Projecteur LED avec détecteur de mouvement
I Faretto LED con sensore movimento
E Reflector de diodos con sensor de movimiento
CN 感应灯

20W 1400lm 6000K 230V~50Hz
12m 20000h IP44

COB LED



YATO
YT-81798 16

GB LED lamp with motion detector
D Diodenscheinwerfer mit Bewegungsmelder
PL Reflektor diodowy z czujnikiem ruchu
RUS Светодиодный прожектор с датчиком движения
CZ LED reflektor se snímačem pohybu
H Diódás reflektor mozgásérzékelővel
RO Reflector diodă cu senzor de mișcare
F Projecteur LED avec détecteur de mouvement
I Faretto LED con sensore movimento
E Reflector de diodos con sensor de movimiento
CN 感应灯

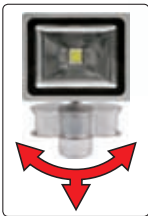
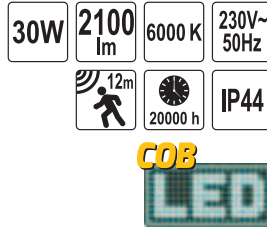

GB LED lamp with motion detector
D Diodenscheinwerfer mit Bewegungsmelder
PL Reflektor diodowy z czujnikiem ruchu
RUS Светодиодный прожектор с датчиком движения
CZ LED reflektor se snímačem pohybu
H Diódás reflektor mozgásérzékelővel
RO Reflector diodă cu senzor de mișcare
F Projecteur LED avec détecteur de mouvement
I Faretto LED con sensore movimento
E Reflector de diodos con sensor de movimiento
CN 感应灯

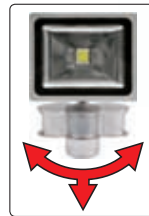
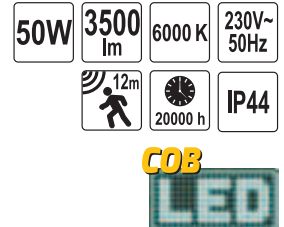

GB Portable LED lamp
D Diodenscheinwerfer mit Tragebügel
PL Reflektor diodowy przenośny
RUS Светодиодный прожектор переносной
CZ LED reflektor přenosný
H Hordozható, diódás reflektor
RO Reflector diodă portabil
F Projecteur LED
I Faretto LED portatilea
E Reflector de diodos portátil
CN 手提式工作灯

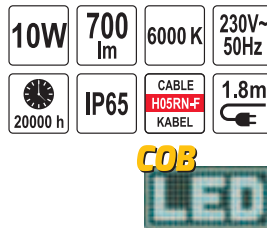

GB Portable LED lamp
D Diodenscheinwerfer, mit Tragebügel
PL Reflektor diodowy przenośny
RUS Светодиодный прожектор переносной
CZ LED reflektor přenosný
H Hordozható, diódás reflektor
RO Reflector diodă portabil
F Projecteur LED
I Faretto LED portatilea
E Reflector de diodos portátil
CN 手提式工作灯

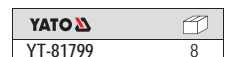
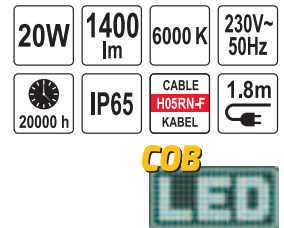

- GB LED lamp with tripod
- D Stativ-Diodenscheinwerfer
- PL Reflektor diodowy na stojaku
- RUS Светодиодный прожектор на стойке
- CZ LED reflektor na stojanu
- H Allvanyos diódás reflektor
- RO Reflector diodă pe stativ
- F Projecteur LED sur un trépied
- I Riflettore LED sul cavalletto
- E Reflector de diodos con tripie
- CN 灯

20W	6000 K
1400 lm	20000 h
230V~50Hz	IP65
CABLE H05RN-F KABEL	3m

COB
LED



YATO **YT-81788** 2

- GB LED lamp with tripod
- D Stativ-Diodenscheinwerfer
- PL Reflektor diodowy na stojaku
- RUS Светодиодный прожектор на стойке
- CZ LED reflektor na stojanu
- H Allvanyos diódás reflektor
- RO Reflector diodă pe stativ
- F Projecteur LED sur un trépied
- I Riflettore LED sul cavalletto
- E Reflector de diodos con tripie
- CN 灯

30W	6000 K
2250 lm	20000 h
230V~50Hz	IP65
CABLE H05RN-F KABEL	3m

COB
LED

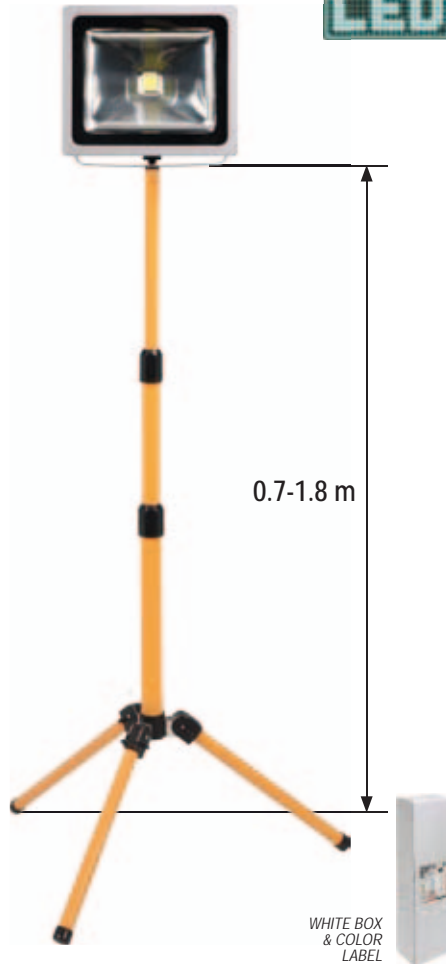

YATO **YT-81810** 2

- GB LED lamp with tripod
- D Stativ-Diodenscheinwerfer
- PL Reflektor diodowy na stojaku
- RUS Светодиодный прожектор на стойке
- CZ LED reflektor na stojanu
- H Allvanyos diódás reflektor
- RO Reflector diodă pe stativ
- F Projecteur LED sur un trépied
- I Riflettore LED sul cavalletto
- E Reflector de diodos con tripie
- CN 灯

20W x2	6000 K
1400lm x2	20000 h
230V~50Hz	IP65
CABLE H05RN-F KABEL	3m

COB
LED

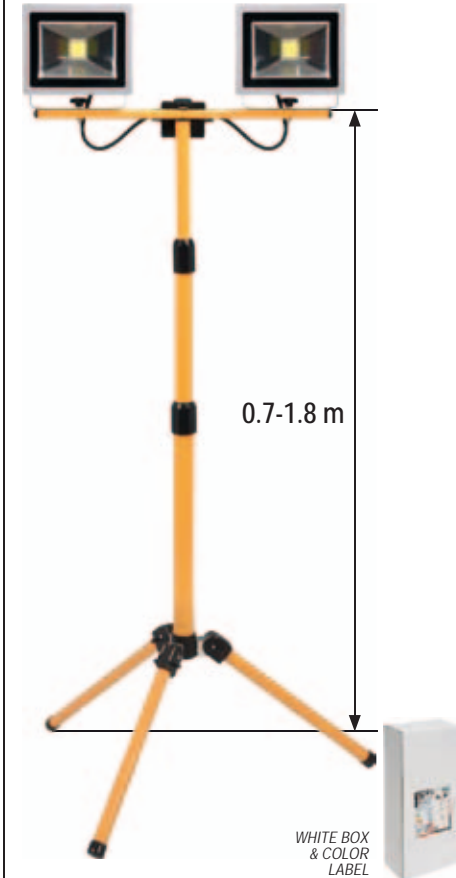

YATO **YT-81789** 4

- GB Solar LED wall lamp
- D LED Solar-Wandleuchte
- PL Lampa ścienna solarna LED
- RUS Настінний світильник
- CZ LED solární světla
- H Fali lámpa napelemes LED
- RO Lampă solara pt. perete
- F Lampe solaire LED
- I Lampada da parete LED solare
- E Luz de pared de LED solar
- CN 太阳能感应壁灯

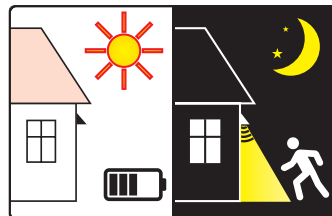

COLOR BOX

SMD
LED

120 lm	3.7V 900mAh Li-Ion!
CHARGING TIME CZAS ŁADOWANIA	WORK TIME CZAS PRACY
8 h	12 h
3m	IP65
OFF ON	



YATO **YT-81855** 12/48

YATO **YT-81856** 12/48

GB Workshop LED battery lamp
D LED Akku-handleuchte
PL Diodowa lampa warsztatowa akumulatorowa
RUS Светодиодная беспроводная лампа
CZ Ruční svítidla LED
H Ledes szerelőlámpa címkéjű cikkek
RO Lampa portabila cu acumulator leduri
F Lampe a LED rechargeable
I Lampada LED per officina
E Linterna LED recargable
CN 可充養駁釘腑



HANGING
COLOR BOX
WITH WINDOW

YATO
YT-08563 10

3W **3.7V**
2200mAh
Li-Ion

250
lm **6000 K**

230V~50Hz
BATTERY CHARGER
ŁADOWARKA

CHARGING TIME
CZAS ŁADOWANIA
5 h

WORK TIME
CZAS PRACY
3.5 h

IP54

IK07

POLYCARBONATE DIFFUSER
KŁOSZ Z POLIWĘGLANU

MAGNETIC

COB
LED



GB Workshop LED battery lamp
D LED Akku-handleuchte
PL Diodowa lampa warsztatowa akumulatorowa
RUS Светодиодная беспроводная лампа
CZ Ruční svítidla LED
H Ledes szerelőlámpa címkéjű cikkek
RO Lampa portabila cu acumulator leduri
F Lampe a LED rechargeable
I Lampada LED per officina
E Linterna LED recargable
CN 可充養駁釘腑

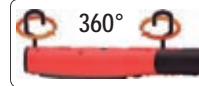

HANGING
COLOR BOX

YATO
YT-08508 12

FRONT LIGHTING
FUNKCJA LATARNI

3.5+3
W **3.7V**
2200mAh
Li-Ion

280
lm **6000 K**

USB
BATTERY CHARGER
ŁADOWARKA

CHARGING TIME
CZAS ŁADOWANIA
5.5 h

WORK TIME
CZAS PRACY
3.5 h

IP54

IK07

POLYCARBONATE DIFFUSER
KŁOSZ Z POLIWĘGLANU

MAGNETIC

SMD
LED

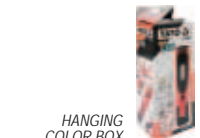
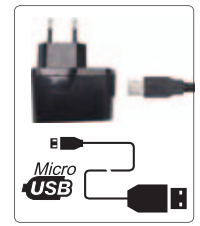

HANGING
COLOR BOX

GB Workshop LED battery lamp
D LED Akku-handleuchte
PL Diodowa lampa warsztatowa akumulatorowa
RUS Светодиодная беспроводная лампа
CZ Ruční svítidla LED
H Ledes szerelőlámpa címkéjű cikkek
RO Lampa portabila cu acumulator leduri
F Lampe a LED rechargeable
I Lampada LED per officina
E Linterna LED recargable
CN 可充養駁釘腑



CRI
95

COLOR INSPECTION LAMP
LAMPA DO INSPEKCJI
LAKIERU



HANGING
COLOR BOX

YATO
YT-08509 12

CRI 95 **5W** **3.7V**
2600mAh
Li-Ion

400
lm **4500 K**

CHARGING TIME
CZAS ŁADOWANIA
4h

WORK TIME
CZAS PRACY
4h

IP65 **IK07**

HOOK HAK **2x**

COB
LED

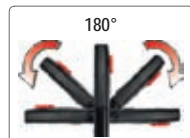

GB Workshop LED battery lamp
D LED Akku-handleuchte
PL Diodowa lampa warsztatowa akumulatorowa
RUS Светодиодная беспроводная лампа
CZ Ruční svítidla LED
H Ledes szerelőlámpa címkéjű cikkek
RO Lampa portabila cu acumulator leduri
F Lampe a LED rechargeable
I Lampada LED per officina
E Linterna LED recargable
CN 可充養駁釘腑



COB
LED



COLOR
BOX

YATO
YT-08502 10

FRONT LIGHTING
FUNKCJA LATARNI

1+1
LED **3.7V**
3600mAh
Li-Ion

180
lm **12V**
BATTERY CHARGER
ŁADOWARKA

230V~50Hz
BATTERY CHARGER
ŁADOWARKA

CHARGING TIME
CZAS ŁADOWANIA
4h

WORK TIME
CZAS PRACY
3 h
2 LED

HOOK HAK **MAGNETIC**

GB Workshop LED battery lamp
 D LED Akku-handleuchte
 PL Diodowa lampa warsztatowa akumulatorowa
 RUS Светодиодная беспроводная лампа
 CZ Ruční svítidla LED
 H Ledes szerelőlámpa címkéjű cikkek
 RO Lampa portabila cu acumulator leduri
 F Lampe a LED rechargeable
 I Lampada LED per officina
 E Linterna LED recargable
 CN 可充莫款釘附

FRONT LIGHTING
 FUNKCIA LATARNI

3+1 LED

3.7V
 3600mAh
Li-Ion!

250 lm

230V~50Hz
 BATTERY CHARGER
 LADOWARKA

12V
 BATTERY CHARGER
 LADOWARKA

CHARGING TIME
 CZAS LADOWANIA

4.5 h

WORK TIME
 CZAS PRACY

5 h
 3 LED

HOOK HAK

MAGNETIC

IP64



COLOR BOX

YATO

YT-08561

10

POWER LED

GB Workshop LED battery lamp
 D LED Akku-handleuchte
 PL Diodowa lampa warsztatowa akumulatorowa
 RUS Светодиодная беспроводная лампа
 CZ Ruční svítidla LED
 H Ledes szerelőlámpa címkéjű cikkek
 RO Lampa portabila cu acumulator leduri
 F Lampe a LED rechargeable
 I Lampada LED per officina
 E Linterna LED recargable
 CN 可充莫款釘附

FRONT LIGHTING
 FUNKCIA LATARNI

30+7 LED

140 lm

3.7V
 2000mAh
Li-Ion!

USB
 BATTERY CHARGER
 LADOWARKA

WORK TIME
 CZAS PRACY

4h

CHARGING TIME
 CZAS LADOWANIA

4h

x3

x2
 HOOK HAK

POLYCARBONATE DIFFUSER
 KLOSKI
 Z PROMIENNIKI

LED

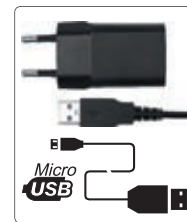
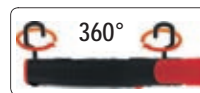
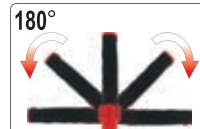

HANGING COLOR BOX

YATO

YT-08507

12

GB Workshop LED battery lamp
 D LED Akku-handleuchte
 PL Diodowa lampa warsztatowa akumulatorowa
 RUS Светодиодная беспроводная лампа
 CZ Ruční svítidla LED
 H Ledes szerelőlámpa címkéjű cikkek
 RO Lampa portabila cu acumulator leduri
 F Lampe a LED rechargeable
 I Lampada LED per officina
 E Linterna LED recargable
 CN 可充莫款釘附

27 LED

13000 MCD

3.6V
 1200mAh
NI-MH!

12V
 BATTERY CHARGER
 LADOWARKA

230V~50Hz
 BATTERY CHARGER
 LADOWARKA

WATER PROOF
 ODPORNIA
 NA WODE

WORK TIME
 CZAS PRACY

4h

CHARGING TIME
 CZAS LADOWANIA

4h

HOOK HAK

MAGNETIC

LED



DOUBLE BLISTER

YATO

YT-08523

10

GB Workshop LED battery lamp
 D LED Akku-handleuchte
 PL Diodowa lampa warsztatowa akumulatorowa
 RUS Светодиодная беспроводная лампа
 CZ Ruční svítidla LED
 H Ledes szerelőlámpa címkéjű cikkek
 RO Lampa portabila cu acumulator leduri
 F Lampe a LED rechargeable
 I Lampada LED per officina
 E Linterna LED recargable
 CN 可充莫款釘附

FRONT LIGHTING
 FUNKCIA LATARNI

30+7 LED

13000 MCD

3.6V
 1200mAh
NI-MH!

12V
 BATTERY CHARGER
 LADOWARKA

230V~50Hz
 BATTERY CHARGER
 LADOWARKA

CHARGING TIME
 CZAS LADOWANIA

4-5 h

WORK TIME
 CZAS PRACY

15h
 7LED

WORK TIME
 CZAS PRACY

4h
 30LED

HOOK HAK

MAGNETIC

LED



COLOR BOX

YATO

YT-08505

10

GB Rechargeable work lamp
D Led Werkstattlampe
PL Diodowa lampa warsztatowa
RUS Светодиодная лампа LED
CZ Montážní lampa diodová bezpřívodová
H Ledlámpa
RO Lampa cu LED
F Lampe a LED rechargeable
I Lampada LED per officina
E Lámpara inalámbrica de diodos
CN 可充电工作灯



60+1 LED	13000 MCD	7.2V 800mAh Ni-MH	230V~50Hz BATTERY CHARGER LADOWARKA
WORK TIME CZAS PRACY 4h	CHARGING TIME CZAS ŁADOWANIA 4h	WATER PROOF ODPORNÁ NA WODĘ	
12V BATTERY CHARGER LADOWARKA	HOOK HAK	MAGNETIC	

LED

DOUBLE BLISTER



YATO 
YT-0852 5/20

GB LED workshop lamp
D LED Werkstattlampe
PL Diodowa lampa warsztatowa
RUS Светодиодный светильник для мастерской
CZ Montážní lampa
H LED lámpa
RO Lampa cu LED
F Lampe d'atelier a LED
I Lampada LED per autofficina
E Lámpara de taller LED
CN 可充黃狀釘脩



8 LED	80 lm	1.5V 3x AAA!	WORK TIME CZAS PRACY 20 h 8 LED
--------------	--------------	---------------------	--

SMD LED

SLIDING CARD



YATO 
YT-08514 12/72

GB LED workshop lamp
D LED Werkstattlampe
PL Diodowa lampa warsztatowa
RUS Светодиодная беспроводная лампа
CZ Montážní lampa
H LED lámpa
RO Lampa cu LED
F Lampe d'atelier a LED
I Lampada LED per autofficina
E Lámpara de taller LED
CN 可充黃狀釘脩



8+1 LED	280 lm	3 LIGHTING OPTIONS OPTIC SWITCHEW FUNKCIA LAMPY	FRONT LIGHTING FUNKCIA LAMPY
WORK TIME CZAS PRACY 4 h 9 LED	1.5V 3x AA	HOOK HAK	MAGNETIC

SMD LED



COLOR BOX



YATO 
YT-08513 50

GB LED workshop lamp
D LED Werkstattlampe
PL Diodowa lampa warsztatowa
RUS Светодиодная лампа LED
CZ Montážní lampa
H LED lámpa
RO Lampa cu LED
F Lampe d'atelier a LED
I Lampada LED per autofficina
E Lámpara de taller LED
CN 可充黃狀釘脩



4 LED	400 lm	IP65	CABLE HO5RN-F KABEL
230V~50Hz	HOOK HAK	4.9m	

POWER LED

COLOR BOX



YATO 
YT-08531 10

GB Workshop LED battery lamp
 D LED Akku-handleuchte
 PL Diodowa lampa warsztatowa akumulatorowa
 RUS Светодиодная лампа LED
 CZ Ruční svítlna LED
 H Ledes szerelőlámpa címkéjű cikkek

RO Lampa portabila cu acumulator leduri
 F Lampe a LED rechargeable
 I Lampada LED trasportabile per illuminazione di vani motore
 E Linterna LED recargable
 CN 引擎盖检修灯

SMD

LED

100 LED	600 lm	7.4V 2000mAh Li-Ion!
230V~50Hz BATTERY CHARGER LADOWARKA	CHARGING TIME CZAS LADOWANIA 3-4 h	WORK TIME CZAS PRACY 4 h 100 LED
HOOK HAK		MAGNETIC

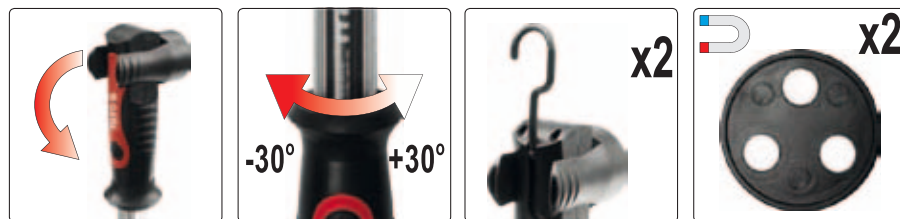

YATO
YT-08503 8

GB Workshop LED battery lamp
 D LED Akku-handleuchte
 PL Diodowa lampa warsztatowa akumulatorowa
 RUS Светодиодная лампа LED
 CZ Ruční svítlna LED
 H Ledes szerelőlámpa címkéjű cikkek

RO Lampa portabila cu acumulator leduri
 F Lampe a LED rechargeable
 I Lampada LED trasportabile per illuminazione di vani motore
 E Linterna LED recargable
 CN 引擎盖检修灯

LED

120 LED	13000 MCD	60 LED	120 LED
7.2V 1800mAh Ni-MH!	230V~50Hz BATTERY CHARGER LADOWARKA	WORK TIME CZAS PRACY 8 h 60 LED	WORK TIME CZAS PRACY 4h 120LED
CHARGING TIME CZAS LADOWANIA 4-5 h		HOOK HAK	
		MAGNETIC	

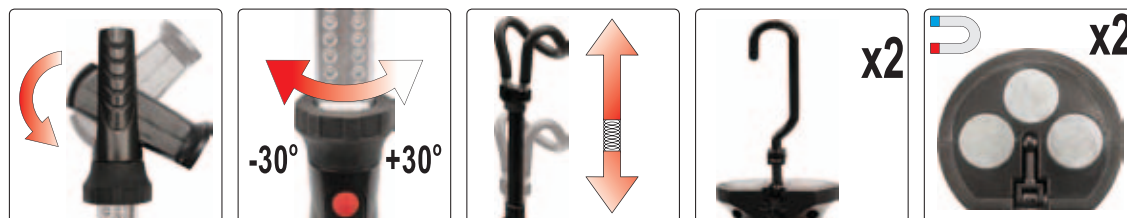

YATO
YT-08530 4

GB Workshop LED battery lamp
 D LED Akku-handleuchte
 PL Diodowa lampa warsztatowa akumulatorowa
 RUS Светодиодная лампа LED
 CZ Ruční svítlna LED
 H Ledes szerelőlámpa címkéjű cikkek

RO Lampa portabila cu acumulator leduri
 F Lampe a LED rechargeable
 I Lampada LED trasportabile per illuminazione di vani motore
 E Linterna LED recargable
 CN 引擎盖检修灯

SMD

LED

12W	1200 lm	4000 K	230V~50Hz
CABLE HOGRN-F KABEL	5 m	2x 1.0mm ²	POLYCARBONATE DIFFUSER KILBSE Z POLIINSLANU
HOOK HAK		IP54	

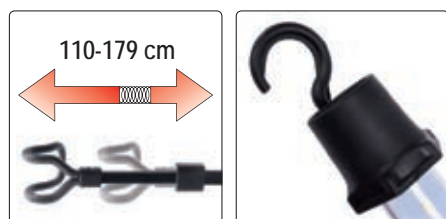

YATO
YT-08532 8

- GB LED aluminium torch
D LED Taschenlampe aus Aluminium
PL Latarka aluminiowa LED
RUS LED алюминиевый фонарик
CZ LED svítilna z hliníku
H LED-es fém zseblámpa
RO LED lanternă aluminiu
F LED lampe de torche en aluminium
I Torcia in alluminio
E LED linterna de aluminio
CN LED 铝合金手电筒

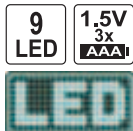

SLIDING CARD

YATO			
YT-08570		24/192	

- GB High power diode torch with zoom function
D Hochleistungs diode Taschenlampe mit Zoom-Funktion
PL Latarka z diodą wysokiej mocy oraz funkcją zoom
RUS Фонарик с LED высокой мощности и функцией зума
CZ Svítilna s LED vysoký výkon a funkce zoom
H Elemlámpa LED-es nagy teljesítményű és zoom funkcióval
RO Lanternă cu LED-uri de mare putere și funcția de zoom
F Lampe de poche avec LED haute puissance et la fonction de zoom
I Torcia di metallo
E Linterna con LED de alta potencia y función de zoom
CN 手电筒LED高功率和变焦功能



SLIDING CARD

YATO	W	lm	
YT-08571	3	100	24/96

- GB High power diode torch with zoom function
D Hochleistungs diode Taschenlampe mit Zoom-Funktion
PL Latarka z diodą wysokiej mocy oraz funkcją zoom
RUS Фонарик с LED высокой мощности и функцией зума
CZ Svítilna s LED vysoký výkon a funkce zoom
H Elemlámpa LED-es nagy teljesítményű és zoom funkcióval
RO Lanternă cu LED-uri de mare putere și funcția de zoom
F Lampe de poche avec LED haute puissance et la fonction de zoom
I Torcia di metallo
E Linterna con LED de alta potencia y función de zoom
CN 手电筒LED高功率和变焦功能

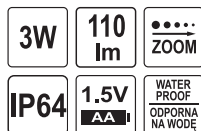

SLIDING CARD

YATO	W	lm	
YT-08572	3	110	12/72

- GB High power diode torch with zoom function
D Hochleistungs diode Taschenlampe mit Zoom-Funktion
PL Latarka z diodą wysokiej mocy oraz funkcją zoom
RUS Фонарик с LED высокой мощности и функцией зума
CZ Svítilna s LED vysoký výkon a funkce zoom
H Elemlámpa LED-es nagy teljesítményű és zoom funkcióval
RO Lanternă cu LED-uri de mare putere și funcția de zoom
F Lampe de poche avec LED haute puissance et la fonction de zoom
I Torcia di metallo
E Linterna con LED de alta potencia y función de zoom
CN 手电筒LED高功率和变焦功能

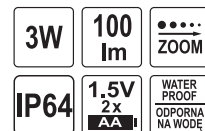

SLIDING CARD

YATO	W	lm	
YT-08575	3	100	12/72

- GB High power diode torch with zoom function
D Hochleistungs diode Taschenlampe mit Zoom-Funktion
PL Latarka z diodą wysokiej mocy oraz funkcją zoom
RUS Фонарик с LED высокой мощности и функцией зума
CZ Svítilna s LED vysoký výkon a funkce zoom
H Elemlámpa LED-es nagy teljesítményű és zoom funkcióval
RO Lanternă cu LED-uri de mare putere și funcția de zoom
F Lampe de poche avec LED haute puissance et la fonction de zoom
I Torcia di metallo
E Linterna con LED de alta potencia y función de zoom
CN 手电筒LED高功率和变焦功能

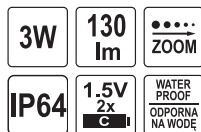

SLIDING CARD

YATO	W	lm	
YT-08577	3	130	12/48

- GB LED head lamp
D LED kopflampe
PL Diodowa lampka czołowa
RUS Налобный светодиодный фонарь
CZ LED montážní lampa - čelovka
H LED fejlámpa
RO Lampă cu LED
F Lampe frontale LED
I Lampada da testa
E Linterna de diodo
CN LED头灯





SLIDING CARD

YATO	W	lm	
YT-08590	3	100	50/100

GB Rubber protection extension cord
 D Gummiisolierte Verlängerungsschnur
 PL Przedłużacz w osłonie gumowej
 RUS Удлинитель с резиновой изоляцией
 CZ Prodlužovací kabel s gumovou izolací
 H Gumi szigetelésű hosszabbító
 RO Cablu prelungitor cauciuc
 F Rallonge électrique
 I Prolunga in gomma
 E Cable de extensión con protección de caucho
 CN 电缆延长线



IP44 **16A**

CABLE **H05RR-F** **3G1.5 mm²**
 KABEL CABLE / KABEL

 
 TYPE / TYP

230V~50Hz





YATO 	L (m)	
YT-81021	10	8
YT-81022	20	4
YT-81023	30	4
YT-81024	40	2

GB Rubber protection extension cord
 D Gummiisolierte Verlängerungsschnur
 PL Przedłużacz w osłonie gumowej
 RUS Удлинитель с резиновой изоляцией
 CZ Prodlužovací kabel s gumovou izolací
 H Gumi szigetelésű hosszabbító
 RO Cablu prelungitor cauciuc
 F Rallonge électrique
 I Prolunga in gomma
 E Cable de extensión con protección de caucho
 CN 电缆延长线

IP44 **16A**



CABLE **H05RR-F** **3G2.5 mm²**
 KABEL CABLE / KABEL

 
 TYPE / TYP

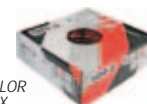
230V~50Hz





COLOR BOX

YATO 	L (m)	
YT-8100	20	4
YT-8101	30	2
YT-8102	40	2

GB Rubber protection extension cord
 D Gummiisolierte Verlängerungsschnur
 PL Przedłużacz w osłonie gumowej
 RUS Удлинитель с резиновой изоляцией
 CZ Prodlužovací kabel s gumovou izolací
 H Gumi szigetelésű hosszabbító
 RO Cablu prelungitor cauciuc
 F Rallonge électrique
 I Prolunga in gomma
 E Cable de extensión con protección de caucho
 CN 电缆延长线



IP44 **16A**

CABLE **H07RN-F** **3G1.5 mm²**
 KABEL CABLE / KABEL

 
 TYPE / TYP

230V~50Hz





YATO 	L (m)	
YT-8111	5	16
YT-8112	10	8

GB Rubber protection extension cord
 D Gummiisolierte Verlängerungsschnur
 PL Przedłużacz w osłonie gumowej
 RUS Удлинитель с резиновой изоляцией
 CZ Prodlužovací kabel s gumovou izolací
 H Gumi szigetelésű hosszabbító
 RO Cablu prelungitor cauciuc
 F Rallonge électrique
 I Prolunga in gomma
 E Cable de extensión con protección de caucho
 CN 电缆延长线



IP44 **16A**

CABLE **H07RN-F** **3G1.5 mm²**
 KABEL CABLE / KABEL

 
 TYPE / TYP

230V~50Hz





YATO 	L (m)	
YT-8116	10	4
YT-81162	20	4

GB Cable reel
D Kabeltrommel
PL Przedłużacz zwijany
RUS Удлинитель электрический
CZ Bubnový prodloužovač
H Kábeldob
RO Prelungitor pe tambur
F Rallonge électrique sur tambour enrouleur
I Avvolgicavo con bobina
E Cable de prolongación de tambor
CN 电缆延长线



IP44 **16A**
CABLE **H05RR-F** **3G1.5** mm²
KABEL CABLE (KABEL)
E & F TYPE / TYP E TYPE / TYP
230V~50Hz

• $P_{max} = 1000\text{ W}$ coiled
 $P_{max} = 1000\text{ W}$ zwinięty
• $P_{max} = 3000\text{ W}$ uncoiled
 $P_{max} = 3000\text{ W}$ rozwinięty



YATO 	L (m)	
YT-81052	20	2
YT-81053	30	2
YT-81054	40	2

GB Cable reel
D Kabeltrommel
PL Przedłużacz zwijany
RUS Удлинитель электрический
CZ Bubnový prodloužovač
H Kábeldob
RO Prelungitor pe tambur
F Rallonge électrique sur tambour enrouleur
I Avvolgicavo con bobina
E Cable de prolongación de tambor
CN 电缆延长线



IP44 **16A**
CABLE **H05RR-F** **3G2.5** mm²
KABEL CABLE (KABEL)
E & F TYPE / TYP E TYPE / TYP
PLASTIC REEL BEBEN PLÁSTIKOVÝ 230V~50Hz

• $P_{max} = 1200\text{ W}$ coiled
 $P_{max} = 1200\text{ W}$ zwinięty
• $P_{max} = 3600\text{ W}$ uncoiled
 $P_{max} = 3600\text{ W}$ rozwinięty

YATO 	L (m)	
YT-8106	30	1
YT-8107	40	1
YT-8108	50	1



GB Drum power extension cord
D Verlängerungstrommel für Kraftstrom
PL Przedłużacz bębnowy silowy
RUS Силовой удлинитель барабанного типа
CZ Prodloužovací kabel silový na bubnu
H Háromfázisú hosszabbító dob
RO Derulator cu tambur
F Rallonge électrique sur tambour enrouleur
I Avvolgicavo di forza
E Cilindro de extensión de fuerza
CN 电缆延长线



IP44 **~400V**
~230V
CABLE **H07RN-F** **5G2.5** mm²
KABEL CABLE (KABEL)
3P+N+E SPANNE 2x 2P+E

• ~230V; 2P+E
 $P_{max} = 1200\text{ W}$ coiled
 $P_{max} = 1200\text{ W}$ zwinięty
 $P_{max} = 3000\text{ W}$ uncoiled
 $P_{max} = 3000\text{ W}$ rozwinięty

• ~400V; 3P+N+E
 $P_{max} = 3000\text{ W}$ coiled
 $P_{max} = 3000\text{ W}$ zwinięty
 $P_{max} = 9000\text{ W}$ uncoiled
 $P_{max} = 9000\text{ W}$ rozwinięty

YATO 	L (m)	
YT-8120	25	1

23

Garden tools Narzędzia ogrodnicze



Watering program
Program wodny

478-486



Cordless garden tools & accessories

Ogrodowe narzędzia akumulatorowe i akcesoria

495-496



Hose connectors, male connectors, couplings, hose menders

Złącza, nypły, łączniki, rozgałęźniacze, reparatory..... 478

Hose nozzles (sprinklers) & sets

Zraszacze i zestawy..... 480

Garden hose holders

Stojaki na węże ogrodowe..... 486

Pumps

Pompy..... 486

Cordless chainsaws

Akumulatorowe pilarki łańcuchowe..... 495

Cordless grass trimmers

Akumulatorowe wykasarki..... 496

Cordless hedge trimmers

Akumulatorowe nożyce do żywopłotu..... 496

Pruners & shears

Sekatory i nożyce ogrodowe

487-491



Electric garden tools

Ogrodowe narzędzia elektryczne

497



Electric chainsaws

Elektryczne pilarki łańcuchowe..... 497

Pruners

Sekatory..... 487

Lopping shears

Sekatory do gałęzi..... 489

Leverage tree pruners

Sekatory gąsienicowe..... 490

Hedge shears

Nożyce do żywopłotu..... 491

Grass shears

Nożyce do trawy..... 491

Gasoline garden tools & accessories

Ogrodowe narzędzia spalinowe i akcesoria

497-504



Gasoline sprayers

Opryskiwacze spalinowe..... 497

Gasoline chainsaws

Pilarki spalinowe..... 498

Gasoline brushcutters

Kosy spalinowe..... 499

Gasoline hedge trimmers

Spalinowe nożyce do żywopłotu..... 499

Accessories

Akcesoria..... 500

Bow saws & blades

Piły kabłąkowe i brzeszczoty

492



Axes

Siekiery

492



Hand tools

Narzędzia ręczne

493-494



Small garden tools

Małe narzędzia ogrodowe..... 493

Big garden tools

Duże narzędzia ogrodowe..... 494

GB Hose connector
 D Universal
 Schnellschlauchkupplung
 PL Złącze standard
 RUS Соединитель
 CZ Rychlospojka
 H Fitting
 RO Mufă pt. pistol
 F Raccord standard
 I Connettore standard
 E Junta estandar
 CN 通水接头



GB Waterstop hose connector
 D Universal
 Schnellschlauchkupplung mit Wasserstop
 PL Złącze stop
 RUS Соединитель с автостопом
 CZ Rychlospojka
 H Fitting
 RO Mufă pt. pistol
 F Raccord stop
 I Connettore stop
 E Junta estandar
 CN 止水接头

GB Hose connector
 D Universal
 Schnellschlauchkupplung
 PL Złącze standard
 RUS Соединитель
 CZ Rychlospojka
 H Fitting
 RO Mufă pt. pistol
 F Raccord standard
 I Connettore standard
 E Junta estandar
 CN 通水接头



GB Waterstop hose connector
 D Universal
 Schnellschlauchkupplung mit Wasserstop
 PL Złącze stop
 RUS Соединитель с автостопом
 CZ Rychlospojka
 H Fitting
 RO Mufă pt. pistol
 F Raccord stop
 I Connettore stop
 E Junta estandar
 CN 止水接头



TIED ON CARD



TIED ON CARD



TIED ON CARD



TIED ON CARD

YATO	size / rozmiar	
YT-99801	1/2" 12.5 mm	12/48

YATO	size / rozmiar	
YT-99803	1/2" 12.5 mm	12/48

YATO	size / rozmiar	
YT-99802	3/4" 19.0 mm	12/48

YATO	size / rozmiar	
YT-99804	3/4" 19.0 mm	12/48

GB Hose mender
 D Schlauchreparator,
 Schlauchverbinder
 PL Reparatör do węzła
 RUS Соединитель шлангов
 CZ Opravka
 H Gyorstoldó
 RO Mufă înădire
 F Réparateur de tuyau
 I Tubo reparatore
 E Reparador para manguera
 CN 修补接头



GB Hose mender
 D Schlauchreparator,
 Schlauchverbinder
 PL Reparatör do węzła
 RUS Соединитель шлангов
 CZ Opravka
 H Gyorstoldó
 RO Mufă înădire
 F Réparateur de tuyau
 I Tubo reparatore
 E Reparador para manguera
 CN 修补接头

GB Hose mender
 D Schlauchreparator,
 Schlauchverbinder
 PL Reparatör do węzła
 RUS Соединитель шлангов
 CZ Opravka
 H Gyorstoldó
 RO Mufă înădire
 F Réparateur de tuyau
 I Tubo reparatore
 E Reparador para manguera
 CN 修补接头



GB Snap-in tap adaptor
 D Wasserhahnanschluss
 für Gartenschlauch
 PL Przyłącze do kranu
 RUS Адаптер внутренний
 CZ Šroubení
 H Tömlövég csaphoz
 RO Mufă pt. robinet
 cu filet interior
 F Raccord
 I Collegamento al rubinetto
 E Tubuladura de grifo
 CN 铁箍接头



TIED ON CARD



TIED ON CARD



TIED ON CARD



TIED ON CARD

YATO	size / rozmiar	
YT-99810	1/2" 12.5 mm	12/48

YATO	size / rozmiar	
YT-99811	3/4" 19.0 mm	12/48

YATO	size / rozmiar	
YT-8979	1/2"; 3/4" 12.5; 19.0 mm	24/240

YATO	size / rozmiar	
YT-8970	1/2" 12.5 mm	24/240

GB Snap-in tap adaptor
 D Wasserhahnanschluss
 für Gartenschlauch
 PL Przyłącze do kranu
 RUS Адаптер внутренний
 CZ Šroubení
 H Tömlövég csaphoz
 RO Mufă pt. robinet
 cu filet interior
 F Raccord
 I Collegamento al rubinetto
 E Tubuladura de grifo
 CN 铁箍接头



GB Snap-in tap adaptor
 D Wasserhahnanschluss
 für Gartenschlauch
 PL Przyłącze do kranu
 RUS Адаптер внутренний
 CZ Šroubení
 H Tömlövég csaphoz
 RO Mufă pt. robinet
 cu filet interior
 F Raccord
 I Collegamento al rubinetto
 E Tubuladura de grifo
 CN 铁箍接头

GB Snap-in tap adaptor
 D Wasserhahnanschluss
 für Gartenschlauch
 PL Przyłącze do kranu
 RUS Адаптер внутренний
 CZ Šroubení
 H Tömlövég csaphoz
 RO Mufă pt. robinet
 cu filet interior
 F Raccord
 I Collegamento al rubinetto
 E Tubuladura de grifo
 CN 铁箍接头



GB Snap-in tap adaptor
 D Wasserhahnanschluss
 für Gartenschlauch
 PL Przyłącze do kranu
 RUS Адаптер внутренний
 CZ Šroubení
 H Tömlövég csaphoz
 RO Mufă pt. robinet
 cu filet interior
 F Raccord
 I Collegamento al rubinetto
 E Tubuladura de grifo
 CN 铁箍接头



TIED ON CARD



TIED ON CARD



TIED ON CARD



TIED ON CARD

YATO	size / rozmiar	
YT-8971	3/4" 19.0 mm	12/120

YATO	size / rozmiar	
YT-99812	3/4" 19.0 mm	12/120

YATO	size / rozmiar	
YT-8972	1" 25.0 mm	12/120

YATO	size / rozmiar	
YT-99813	1" 25.0 mm	12/120

GB Snap-in tap adaptor
D Wasserhahnanschluss für Gartenschlauch
PL Przyłącze do kranu
RUSAдaптер внyтpeнний
CZ Šroubení
H Tömlovég csaphoz
RO Mufă pt. robinet cu file interior
F Raccord
I Collegamento al rubinetto
E Tubuladura de grifo
CN 铁箍接头

1/2"
12.5mm
3/4"
19mm
ABS



TIED ON CARD

YATO	size / rozmiar	
YT-8973	1/2"; 3/4" 12.5; 19.0 mm	12/120

GB Snap-in tap adaptor
D Wasserhahnanschluss für Gartenschlauch
PL Przyłącze do kranu
RUSAдaптер внyтpeнний
CZ Šroubení
H Tömlovég csaphoz
RO Mufă pt. robinet cu file interior
F Raccord
I Collegamento al rubinetto
E Tubuladura de grifo
CN 铁箍接头

1/2"
12.5mm
3/4"
19mm
ABS



TIED ON CARD

YATO	size / rozmiar	
YT-99814	1/2"; 3/4" 12.5; 19.0 mm	12/120

GB Snap-in tap adaptor
D Wasserhahnanschluss für Gartenschlauch
PL Przyłącze do kranu
RUSAдaптер внyтpeнний
CZ Šroubení
H Tömlovég csaphoz
RO Mufă pt. robinet cu file interior
F Raccord
I Collegamento al rubinetto
E Tubuladura de grifo
CN 铁箍接头

3/4"
19mm
1"
25mm
ABS



TIED ON CARD

YATO	size / rozmiar	
YT-8974	3/4"; 1" 19.0; 25.0 mm	12/120

GB Snap-in tap adaptor
D Wasserhahnanschluss für Gartenschlauch
PL Przyłącze do kranu
RUSAдaптер внyтpeнний
CZ Šroubení
H Tömlovég csaphoz
RO Mufă pt. robinet cu file interior
F Raccord
I Collegamento al rubinetto
E Tubuladura de grifo
CN 铁箍接头

3/4"
19mm
1"
25mm
ABS



TIED ON CARD

YATO	size / rozmiar	
YT-99815	3/4"; 1" 19.0; 25.0 mm	12/120

GB Snap-in tap adaptor
D Wasserhahnanschluss für Gartenschlauch
PL Przyłącze do kranu
RUSAдaптер внyтpeнний
CZ Šroubení
H Tömlovég csaphoz
RO Mufă pt. robinet cu file interior
F Raccord
I Collegamento al rubinetto
E Tubuladura de grifo
CN 铁箍接头

3/4"
19mm
ABS



TIED ON CARD

YATO	size / rozmiar	
YT-8975	3/4" 19.0 mm	24/240

GB 2 way coupling
D Schlauchkupplung
PL Złącze typu „I”
RUSСоединитель шлангов
CZ Spojka
H „I” típusú csötöldő idom
RO Prelungitor furtun apă
F Connecteur type „I”
I Connettore tipo „I”
E Junta tipo „I”
CN 双向水管接头

ABS



TIED ON CARD

YATO	size / rozmiar	
YT-8976		24/240

GB 3 way coupling
D Drei wege kupplung
PL Rozdzielacz typu „Y”
RUSТройник для шлангов
CZ Y-kus
H „Y” típusú elágazás
RO Distributor 3 căi
F Dérivation type „Y”
I Connettore tipo „Y”
E Distribuidor tipo „Y”
CN 三向水管接头

ABS



TIED ON CARD

YATO	size / rozmiar	
YT-8977		24/240

GB Y-switch coupling with swivel
D 2-Wege Ventil
PL Rozdzielacz z zaworami
RUSРаспределитель внешний
CZ Rozbočovač s uzavíracími ventily
H Y-elágazó, 2 db külső menetes elzáróval
RO Racord iny cu robinet
F Dérivation type „Y”
I Distributore con valvole
E Distribuidor tipo „Y”
CN 双通水管转换接头

1/2"
12.5mm
ABS



TIED ON CARD

YATO	size / rozmiar	
YT-8978	1/2" 12.5 mm	24/240

GB One way tap adaptor
D Garten-Ventil
PL Zawór ogrodowy
RUSВентиль
CZ Ventil
H Szelep
RO Robinet
F Raccord régulateur
I Valvola giardino
E Válvula
CN 接头

3/4"
19mm
BRASS
MOSIADZ



TIED ON CARD

YATO	size / rozmiar	
YT-9940	3/4" 19.0 mm	12/48

GB Y-switch coupling with swivel
D 2-Wege Ventil
PL Rozdzielacz z zaworami
RUSРаспределитель внешний
CZ Rozbočovač s uzavíracími ventily
H Y-elágazó, 2 db külső menetes elzáróval
RO Racord iny cu robinet
F Soupape double
I Distributore con valvole
E Distribuidor tipo „Y”
CN 两用转换接头

3/4"
19mm
1"
25mm
ABS



TIED ON CARD

YATO	size / rozmiar	
YT-99848	3/4"; 1" 19.0; 25.0 mm	12/48

GB Y-switch coupling with swivel
D 2-Wege Ventil
PL Rozdzielacz z zaworami
RUSРаспределитель внешний
CZ Rozbočovač s uzavíracími ventily
H Y-elágazó, 2 db külső menetes elzáróval
RO Racord iny cu robinet
F Raccord régulateur double
I Distributore con valvole
E Distribuidor tipo „Y”
CN 两用转换接头

3/4"
19mm
BRASS
MOSIADZ



TIED ON CARD

YATO	size / rozmiar	
YT-9941	3/4" 19.0 mm	12/48

GB Adjustable spray nozzle
 D Spritze
 PL Zraszacz prosty regulowany
 RUS Распылитель поливочный
 CZ Postřikovač
 H Szórófej
 RO Stropitor apă

F Pistolet d'arrosage droit et réglé
 I Semplice sprinkler regolabile
 E Rociador
 CN 铝合金调节式水枪

Zn ABS

GB Adjustable spray nozzle
 D Spritze
 PL Zraszacz prosty regulowany
 RUS Распылитель поливочный
 CZ Postřikovač
 H Szórófej
 RO Stropitor apă

F Pistolet d'arrosage droit et réglé
 I Semplice sprinkler regolabile
 E Rociador
 CN 铝合金调节式水枪

ABS FLOW REGULATION PRZEPLYWU



TIED ON CARD



TIED ON CARD

YATO
 YT-8950 12/48

YATO
 YT-99830 12/48

GB Adjustable spray gun
 D Regelbare Sprühpistole
 PL Pistolet zraszający regulowany
 RUS Регулируемый оросительный пистолет
 CZ Kropící pistole regulovatelná

H Öntöző pisztoly, állítható sugarú
 RO Pistolet de irigare ajustabil
 F Pistolet d'arrosage réglé
 I Pistola a spruzzo regolabile
 E Pistola rociadora ajustable
 CN 调节式水枪

AI ABS

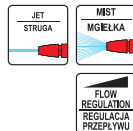

TIED ON CARD

YATO
 YT-8965 12/48

GB Adjustable spray gun
 D Regelbare Sprühpistole
 PL Pistolet zraszający regulowany
 RUS Регулируемый оросительный пистолет
 CZ Kropící pistole regulovatelná

H Öntöző pisztoly, állítható sugarú
 RO Pistolet de irigare ajustabil
 F Pistolet d'arrosage réglé
 I Pistola a spruzzo regolabile
 E Pistola rociadora ajustable
 CN 调节式水枪

AI ABS

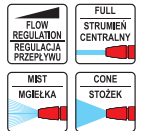

TIED ON CARD

YATO
 YT-8955 12/48

GB Adjustable spray gun
 D Regelbare Sprühpistole
 PL Pistolet zraszający regulowany
 RUS Регулируемый оросительный пистолет
 CZ Kropící pistole regulovatelná

H Öntöző pisztoly, állítható sugarú
 RO Pistolet de irigare ajustabil
 F Pistolet d'arrosage réglé
 I Pistola a spruzzo regolabile
 E Pistola rociadora ajustable
 CN 调节式水枪

AI ABS

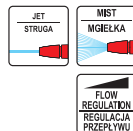

TIED ON CARD

YATO
 YT-8966 12/48

GB Adjustable spray gun
 D Regelbare Sprühpistole
 PL Pistolet zraszający regulowany
 RUS Регулируемый оросительный пистолет
 CZ Kropící pistole regulovatelná

H Öntöző pisztoly, állítható sugarú
 RO Pistolet de irigare ajustabil
 F Pistolet d'arrosage réglé
 I Pistola a spruzzo regolabile
 E Pistola rociadora ajustable
 CN 调节式水枪

AI ABS

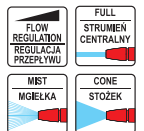

TIED ON CARD

YATO
 YT-8956 12/48

GB Adjustable spray gun
D Regelbare Sprühpistole
PL Pistolet zraszający regulowany
RUS Регулируемый оросительный пистолет
CZ Kropící pistole regulovatelná

H Öntöző pisztoly, állítható sugarú
RO Pistolet de irigare ajustabil
F Pistolet d'arrosage réglé
I Pistola a spruzzo regolabile
E Pistola rociadora ajustable
CN 调节式水枪

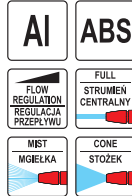

TIED ON CARD



YATO
YT-8957 12/48

GB Adjustable spray gun
D Regelbare Sprühpistole
PL Pistolet zraszający regulowany
RUS Регулируемый оросительный пистолет
CZ Kropící pistole regulovatelná
H Öntöző pisztoly, állítható sugarú

RO Pistolet de irigare ajustabil
F Pistolet d'arrosage réglé
I Pistola a spruzzo regolabile
E Pistola rociadora ajustable
CN 调节式水枪



TIED ON CARD



YATO
YT-8967 12

GB Multifunction sprinkling gun
D Multifunktions-Spritzpistole
PL Wielofunkcyjny pistolet zraszający
RUS Многофункциональный оросительный пистолет
CZ Multifunkční postřikovací pistole
H Többfunkciós öntöző pisztoly

RO Pistol multifuncțional pt. pulverizare
F Pistolet d'arrosage
I Multifunzione pistola a spruzzo
E Pistola para regar multifuncional
CN 六用途调节式水枪



TIED ON CARD



YATO
YT-8958 12/48

GB Multifunction sprinkling gun
D Multifunktions-Spritzpistole
PL Wielofunkcyjny pistolet zraszający
RUS Многофункциональный оросительный пистолет
CZ Multifunkční postřikovací pistole
H Többfunkciós öntöző pisztoly

RO Pistol multifuncțional pt. pulverizare
F Pistolet d'arrosage
I Multifunzione pistola a spruzzo
E Pistola para regar multifuncional
CN 六用途调节式水枪

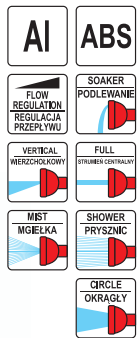

TIED ON CARD



YATO
YT-8964 12/48

GB Multifunction sprinkling gun
D Multifunktions-Spritzpistole
PL Wielofunkcyjny pistolet zraszający
RUS Многофункциональный оросительный пистолет
CZ Multifunkční postřikovací pistole
H Többfunkciós öntöző pisztoly

RO Pistol multifuncțional pt. pulverizare
F Pistolet d'arrosage
I Multifunzione pistola a spruzzo
E Pistola para regar multifuncional
CN 六用途调节式水枪

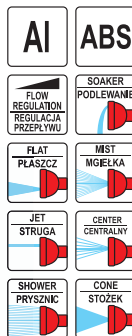

TIED ON CARD



YATO
YT-8963 12/48

GB Multifunction sprinkling gun
D Multifunktions-Spritzpistole
PL Wielofunkcyjny pistolet zraszający
RUS Многофункциональный оросительный пистолет
CZ Multifunkční postřikovací pistole
H Többfunkciós öntöző pisztoly

RO Pistol multifuncțional pt. pulverizare
F Pistolet d'arrosage
I Multifunzione pistola a spruzzo
E Pistola para regar multifuncional
CN 六用途调节式水枪



TIED ON CARD



YATO
YT-8959 12/48

GB Multifunction sprinkling gun
 D Multifunktions-Spritzpistole
 PL Wielofunkcyjny pistolet zraszający
 RUS Многофункциональный оросительный пистолет
 CZ Multifunkční postřikovací pistole
 H Többfunkciós öntöző pisztoly

RO Pistol multifuncțional pt. pulverizare
 F Pistolet d'arrosage
 I Multifunzione pistola a spruzzo
 E Pistola para regar multifuncional
 CN 六用途调节式水枪



TIED ON CARD



YATO
 YT-8960 12/48

GB Multifunction sprinkling gun
 D Multifunktions-Spritzpistole
 PL Wielofunkcyjny pistolet zraszający
 RUS Многофункциональный оросительный пистолет
 CZ Multifunkční postřikovací pistole
 H Többfunkciós öntöző pisztoly

RO Pistol multifuncțional pt. pulverizare
 F Pistolet d'arrosage
 I Multifunzione pistola a spruzzo
 E Pistola para regar multifuncional
 CN 六用途调节式水枪



TIED ON CARD



YATO
 YT-99841 12/48

GB Multifunction sprinkling gun
 D Multifunktions-Spritzpistole
 PL Wielofunkcyjny pistolet zraszający
 RUS Многофункциональный оросительный пистолет
 CZ Multifunkční postřikovací pistole
 H Többfunkciós öntöző pisztoly

RO Pistol multifuncțional pt. pulverizare
 F Pistolet d'arrosage
 I Multifunzione pistola a spruzzo
 E Pistola para regar multifuncional
 CN 六用途调节式水枪

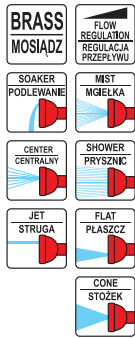

TIED ON CARD



YATO
 YT-8968 12

GB Basic hose set with straight nozzle
 D Bewässerungs Spritz und Anschlussset
 PL Zestaw złączek ze zraszaczem prostym
 RUS Набор поливочный
 CZ Postřikovač + spojky
 H Készlet gyorskapoccsal csaphoz
 RO Ștut furtun apă cu accesorii pt. robinet
 F Set d'arrosage raccord
 I Set raccordi con sprinkler semplice
 E Juego de rociar tubuladura de grifo
 CN 水枪组套



TIED ON CARD



YATO	size / rozmiar	
YT-8940	1/2"; 3/4" 12.5; 19.0 mm	12/48

GB Basic hose set with straight nozzle
 D Bewässerungs Spritz und Anschlussset
 PL Zestaw złączek ze zraszaczem prostym
 RUS Набор поливочный
 CZ Postřikovač + spojky
 H Készlet gyorskapoccsal csaphoz
 RO Ștut furtun apă cu accesorii pt. robinet
 F Set d'arrosage raccord
 I Set raccordi con sprinkler semplice
 E Juego de rociar tubuladura de grifo
 CN 水枪组套



TIED ON CARD



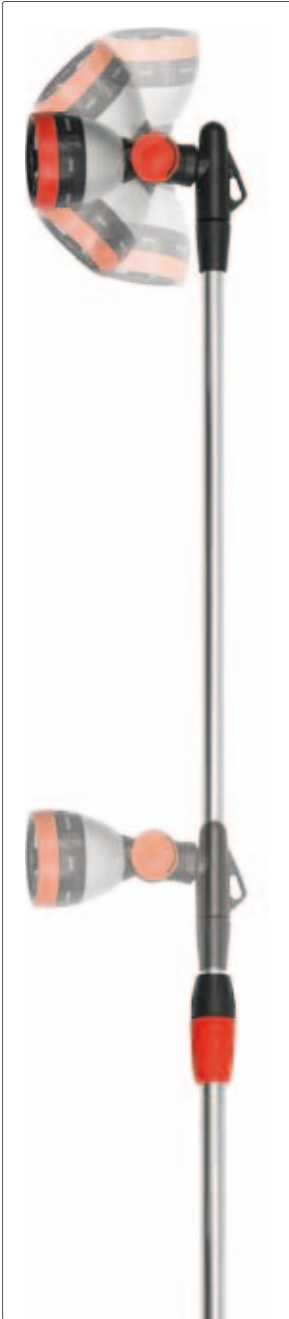
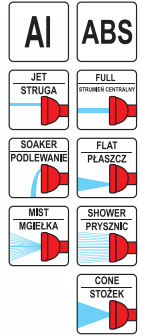

YATO	size / rozmiar	
YT-8941	3/4"; 1" 19.0 mm; 25.0 mm	12/48

- GB Sprinkling lance
D Multifunktions-Spritzstab
PL Lanza zraszająca wielofunkcyjna
RUS Пика для распылителя
многофункциональная
CZ Multifunkční postříkovací nástavec
H Többfunkciós esőztető fej
RO Tijă pt. irigare
F Fusil arrosoir
I Lancia con prolunga
E Lanza para regar multifuncional
CN 长杆喷枪



TIED
ON CARD



YATO 	L (cm)	
YT-8962	90-135	12

- GB Set of gaskets
D Dichtungssatz
PL Zestaw uszczelek do programu wodnego
RUS Набор прокладок
CZ Sada těsnění
H Tömítéskészlet
RO Set de garnituri
- F Kit de joints
I Set di guarnizioni per programma del acqua
E Juego de juntas
CN 垫圈组套

- 2 x Ø16 x Ø11.0 x 2.5
2 x Ø18.5 x Ø11.0 x 3.0
2 x Ø30.0 x Ø20.0 x 3.0
2 x Ø10.0 x Ø6.0 x 2.0
2 x Ø24.0 x Ø15.0 x 3.0
2 x Ø12.0 x Ø8.0 x 2.0
2 x basket



14
PCS



POLYBAG
WITH HEADER

for / dla: YT-8900-YT-8994

YATO 	
YT-9920	20/80

GB Impulse sprinkler
 D Impulsstrenger
 PL Zraszacz impulsowy
 RUS Распылитель импульсный на пике
 CZ Postřikovač
 H Impulzus szórófej
 RO Stropitor apă
 F Arroseur impulsion sur piquet
 I Sprinkler impulso
 E Rociador
 CN 脉冲洒水器

MAX RANGE
 ZASIEG
 МАКСИМАЛЬНЫЙ
 24 m

ZINC
 ALLOY SPIKE
 KOŁEC
 ZE STOPU
 CYNKU

ABS

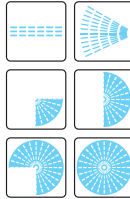

TIED
 ON CARD



YATO
 YT-8985 48

GB Impulse sprinkler
 D Impulsstrenger
 PL Zraszacz impulsowy
 RUS Распылитель импульсный на пике
 CZ Postřikovač
 H Impulzus szórófej
 RO Stropitor apă
 F Arroseur impulsion sur piquet
 I Sprinkler impulso
 E Rociador
 CN 脉冲洒水器

MAX RANGE
 ZASIEG
 МАКСИМАЛЬНЫЙ
 24 m

ZINC
 ALLOY SPIKE
 KOŁEC
 ZE STOPU
 CYNKU

ABS

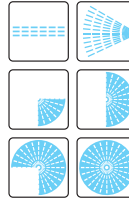

TIED
 ON CARD



YATO
 YT-8986 48

GB 3-arms revolving sprinkler
 D 3-Arm Kreis-Regner
 PL Zraszacz 3-ramienny
 RUS Трехсторонний вращающийся
 распылитель на пике
 CZ Rozprašováč třiramenný
 H Locsoló, leszűrhető, forgó
 RO Aspersol cu 3 brate
 F Arroseur sur piquet 3 branches
 I Tre braccio sprinkler
 E Rociador 3-brazos
 CN 三叉插针洒水器

MAX RANGE
 ZASIEG
 МАКСИМАЛЬНЫЙ
 12 m

ZINC
 ALLOY SPIKE
 KOŁEC
 ZE STOPU
 CYNKU

ABS



TIED
 ON CARD



YATO
 YT-8987 48

GB Tripod impulse sprinkler
 D Impulsstrenger
 PL Zraszacz impulsowy na statywie
 RUS Распылитель импульсный
 CZ Postřikovač
 H Impulzus szórófej
 RO Stropitor apă
 F Arroseur impulsion lance
 I Sprinkler impulso su un treppiede
 E Rociador
 CN 洒水器

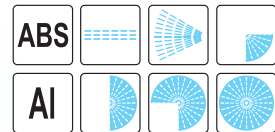

COLOR BOX



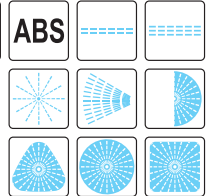

YATO
 YT-8984 12

- GB 8 pattern sprinkler
D 8-Flächenregner
PL Zraszacz 8-funkcyjny
RUS Распылитель 8-позиционный на подставке
CZ Postríkovač
H 8 funkciós szórófej
RO Stropitor apă cu 8 duze
F Turbine d'arrosage 8 fonctionnes
I Sprinkler 8-funzioni
E Rociador 8-funciones de tierra
CN 洒水器



TIED ON CARD

YATO 	
YT-8991	48

- GB Aluminium tube oscillating sprinkler
D Viereckregner
PL Zraszacz oscylacyjny z rurką aluminiową
RUS Распылитель осциллирующий
CZ Postríkovač
H Oszcillációs szórófej
RO Stropitor apă
F Arroseur oscillant aluminium
I Oscillante sprinkler con tubo di alluminio
E Rociador giratorio con tubo de aluminio
CN 摇摆洒水器

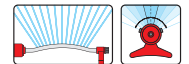
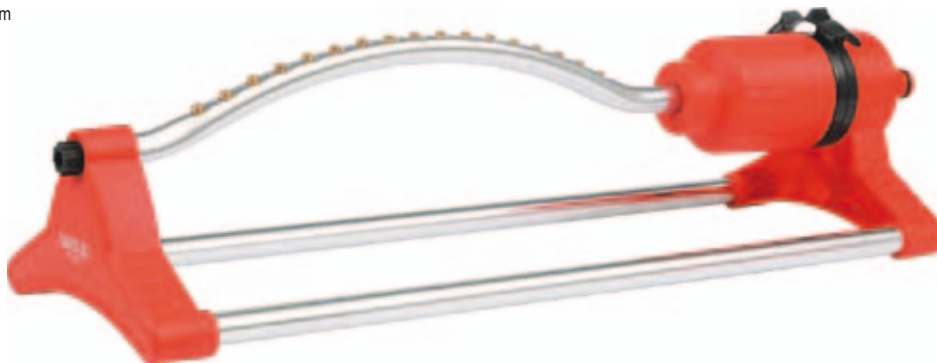

COLOR BOX



YATO 	
YT-8993	6

- GB Tube oscillating sprinkler
D Viereckregner
PL Zraszacz oscylacyjny
RUS Распылитель осциллирующий
CZ Postríkovač
H Oszcillációs szórófej
RO Stropitor apă
F Arroseur oscillant
I Oscillante sprinkler
E Rociador giratorio
CN 摇摆洒水器

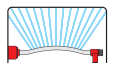

COLOR BOX



YATO 	
YT-99845	6

GB Hose holder
 D Gartenschlauchträger
 PL Stojak do węzła ogrodowego
 RUS Барабан для намотки поливочного шланга
 CZ Stojan navíječl na zahradní hadici
 H Utartódob locsolótömlőhöz
 RO Suport pt. furtun
 F Dévidoir sur roues
 I Carrello avvolgitubo
 E Estante para manguera de jardín
 CN 卷线盘

3/4" (19 mm)
45 m
 1/2" (12.5 mm)
50 m
PP



YATO	hose size / rozmiar węzła (m)	
YT-99850	3/4" (19.0 mm) / 45 m 1/2" (12.5 mm) / 50 m	2

GB Hose holder
 D Gartenschlauchträger
 PL Stojak do węzła ogrodowego
 RUS Барабан для намотки поливочного шланга
 CZ Stojan navíječl na zahradní hadici
 H Utartódob locsolótömlőhöz
 RO Suport pt. furtun
 F Dévidoir sur roues
 I Carrello avvolgitubo
 E Estante para manguera de jardín
 CN 卷线盘

3/4" (19 mm)
45 m
 1/2" (12.5 mm)
50 m
PP



YATO	hose size / rozmiar węzła (m)	
YT-99852	3/4" (19.0 mm) / 45 m 1/2" (12.5 mm) / 50 m	2

GB Hose holder
 D Gartenschlauchträger
 PL Stojak do węzła ogrodowego
 RUS Барабан для намотки поливочного шланга
 CZ Stojan navíječl na zahradní hadici
 H Utartódob locsolótömlőhöz
 RO Suport pt. furtun
 F Dévidoir sur roues
 I Carrello avvolgitubo
 E Estante para manguera de jardín
 CN 卷线盘

3/4" (19 mm)
60 m
 1/2" (12.5 mm)
100 m
PP



YATO	hose size / rozmiar węzła (m)	
YT-99853	3/4" (19.0 mm) / 60 m 1/2" (12.5 mm) / 100 m	2

GB Submersible pump for dirty water and wastewater
 D Tauchpumpe für Schmutzwasser
 PL Pompa zatapiałna do wody brudnej i ścieków
 RUS Погружной насос для грязной воды
 CZ Ponorné čerpadlo pro odpadní vody
 H Búvárszivattyú szennyvíz
 RO Pompă submersibilă pt. apă uzată
 F Pompe submersible pour eaux usees
 I Pompa sommersa per acque reflue
 E Bomba sumergible para aguas residuales
 CN 污水和废水的潜水泵



230V~50Hz
750 W
 Q max 16000 l/h



Δ [m]	Q [l/h]
0	16000
1	15000
2	14000
3	13500
4	12500
5	11500
6	11000
7	10500
8	9500
9	8000
10	5500
11	3500
12	2000
13	500

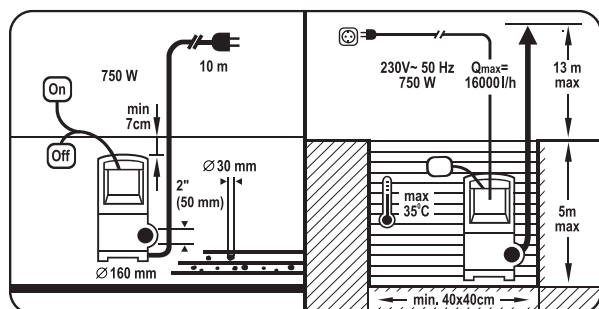

YATO	W	l/h	H (max)	
YT-85350	750	16000	13	1

GB By-pass pruner
D Rebenschere
PL Sekator uniwersalny
RUSСекатор
CZ Nožnice zahradnicke
H Metszoolló

RO Foarfece pt. pomi
F Sécateur traditionnel
I Cesioie universale
E Podadera universal
CN 剪枝剪

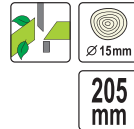

mid carbon steel blades

YATO	L (mm)	
YT-8800	205	12/72

GB By-pass pruner
D Rebenschere
PL Sekator uniwersalny
RUSСекатор
CZ Nožnice zahradnicke
H Metszoolló

RO Foarfece pt. pomi
F Sécateur traditionnel
I Cesioie universale
E Podadera universal
CN 剪枝剪



high carbon steel blades

YATO	L (mm)	
YT-8801	220	12/72

GB Professional anvil pruner
D Amboss-Gartenschere
PL Sekator kowadatkowy
RUSСекатор
CZ Nožnice zahradnicke
H Metszoolló

RO Foarfece pt. pomi
F Sécateur à enclume
I Cesioie anvil
E Podadera de bigornia
CN 棘轮剪枝剪



high carbon steel blades

YATO	L (mm)	
YT-8802	200	12/72

GB By-pass pruner
D Rebenschere
PL Sekator uniwersalny
RUSСекатор
CZ Nožnice zahradnicke
H Metszoolló

RO Foarfece pt. pomi
F Sécateur traditionnel
I Cesioie universale
E Podadera universal
CN 剪枝剪



high carbon steel blades

YATO	L (mm)	
YT-8805	180	12/72

GB Ratchet by-pass pruner
D Gartenschere
PL Sekator z grzechotką
RUSСекатор
CZ Nožnice zahradnicke
H Metszoolló

RO Foarfece pt. pomi
F Sécateur à cliquet
I Cesioie con cricchetto
E Podadera con carraca
CN 棘轮剪枝剪



YATO	L (mm)	
YT-8807	200	12/72

GB Ratchet by-pass pruner
D Gartenschere
PL Sekator z grzechotką
RUSСекатор
CZ Nožnice zahradnicke
H Metszoolló

RO Foarfece pt. pomi
F Sécateur à cliquet
I Cesioie con cricchetto
E Podadera con carraca
CN 棘轮剪枝剪



YATO	L (mm)	
YT-8808	200	12/72

GB Professional anvil pruner
D Amboss-Gartenschere
PL Sekator kowadatkowy
RUSСекатор
CZ Nožnice zahradnicke
H Metszoolló

RO Foarfece pt. pomi
F Sécateur à enclume
I Cesioie anvil
E Podadera de bigornia
CN 棘轮剪枝剪



YATO	L (mm)	
YT-8809	210	12/72

GB By-pass pruner
D Rebenschere
PL Sekator uniwersalny
RUSСекатор
CZ Nožnice zahradnicke
H Metszoolló

RO Foarfece pt. pomi
F Sécateur traditionnel
I Cesioie universale
E Podadera universal
CN 剪枝剪



YATO	L (mm)	
YT-8811	190	12/72

GB By-pass pruner
D Rebenschere
PL Sekator uniwersalny
RUSСекатор
CZ Nožnice zahradnicke
H Metszoolló

RO Foarfece pt. pomi
F Sécateur traditionnel
I Cesioia universale
E Podadera universal
CN 剪枝剪



TRY ME
HALF BLISTER
CARD

YATO	L (mm)	
YT-8845	200	12/72

GB By-pass pruner
D Rebenschere
PL Sekator uniwersalny
RUSСекатор
CZ Nožnice zahradnicke
H Metszoolló

RO Foarfece pt. pomi
F Sécateur traditionnel
I Cesioia universale
E Podadera universal
CN 剪枝剪

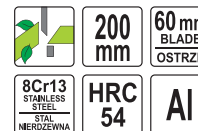

SLIDING
CARD

YATO	L (mm)	
YT-8790	200	12/60

GB Fruit and flower shears
D Blumen- und Rebschere
PL Sekator do obcinania zawiązków
RUSСекатор
CZ Nožnice zahradnicke
H Metszoolló

RO Foarfece pt. pomi
F Sécateur
I Cesioia taglio gemme
E Podadera para cortar germenos
CN 花枝剪



SLIDING
CARD

YATO	L (mm)	
YT-8791	200	12/60

GB Fruit and flower shears
D Blumen- und Rebschere
PL Sekator do obcinania zawiązków
RUSСекатор
CZ Nožnice zahradnicke
H Metszoolló

RO Foarfece pt. pomi
F Sécateur
I Cesioia taglio gemme
E Podadera para cortar germenos
CN 花枝剪



SLIDING
CARD

YATO	L (mm)	
YT-8815	180	12/72

GB Fruit and flower shears
D Blumen- und Rebschere
PL Sekator do obcinania zawiązków
RUSСекатор
CZ Nožnice zahradnicke
H Metszoolló

RO Foarfece pt. pomi
F Sécateur
I Cesioia taglio gemme
E Podadera para cortar germenos
CN 花枝剪



SLIDING
CARD

YATO	L (mm)	
YT-8816	190	12/72

GB Fruit and flower shears
D Blumen- und Rebschere
PL Sekator do obcinania zawiązków
RUSСекатор
CZ Nožnice zahradnicke
H Metszoolló

RO Foarfece pt. pomi
F Sécateur
I Cesioia taglio gemme
E Podadera para cortar germenos
CN 花枝剪



SLIDING
CARD

YATO	L (mm)	
YT-8817	190	12/72

GB By-pass pruner
D Rebenschere
PL Sekator uniwersalny
RUSСекатор
CZ Nožnice zahradnicke
H Metszoolló

RO Foarfece pt. pomi
F Sécateur traditionnel
I Cesioia universale
E Podadera universal
CN 剪枝剪



TRY ME
HALF BLISTER
CARD

YATO	L (mm)	
YT-8843	180	5/60

GB By-pass pruner
D Rebenschere
PL Sekator uniwersalny
RUSСекатор
CZ Nožnice zahradnicke
H Metszoolló

RO Foarfece pt. pomi
F Sécateur traditionnel
I Cesioia universale
E Podadera universal
CN 剪枝剪



TRY ME
HALF BLISTER
CARD

YATO	L (mm)	
YT-8849	200	12/72

GB By-pass lopping shears
D Astschere
PL Sekator do gałęzi
RUSСучкорез
CZ Nožnice zahradnicke
H Ágvágó fix
RO Foarfeca curbata pt. taiat crengi

F Coupe-branches à lame franche
I Cesovia tagliarami
E Podadera para ramas
CN 高枝剪



∅25mm

625mm



HANGING CARD & POUCH ON BLADE

YATO	L (mm)	
YT-8831	625	12

1050 mid carbon steel blades

GB Anvil lopping shears
D Amboss Astschere
PL Sekator kowadełkowy do gałęzi
RUSСучкорез
CZ Nožnice zahradnicke
H Ágvágó fix
RO Foarfeca curbata pt. taiat crengi

F Coupe-branches à éclume
I Cesovia anvil tagliarami
E Podadera para ramas, de bigornia
CN 高枝剪



∅25mm

635mm



HANGING CARD & POUCH ON BLADE

YATO	L (mm)	
YT-8832	635	12

1050 mid carbon steel blades

GB By-pass lopping shears
D Astschere
PL Sekator do gałęzi
RUSСучкорез
CZ Nožnice zahradnicke
H Ágvágó fix
RO Foarfeca curbata pt. taiat crengi

F Coupe-branches à lame franche
I Cesovia tagliarami
E Podadera para ramas
CN 高枝剪



∅35mm

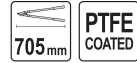

705mm

PTFE COATED



HANGING CARD & POUCH ON BLADE

YATO	L (mm)	
YT-8833	705	12

1050 mid carbon steel blades

GB Anvil lopping shears
D Amboss Astschere
PL Sekator kowadełkowy do gałęzi
RUSСучкорез
CZ Nožnice zahradnicke
H Ágvágó fix
RO Foarfeca curbata pt. taiat crengi

F Coupe-branches à éclume
I Cesovia anvil tagliarami
E Podadera para ramas, de bigornia
CN 高枝剪



∅35mm

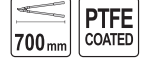

700mm

PTFE COATED



HANGING CARD & POUCH ON BLADE

YATO	L (mm)	
YT-8834	700	12

1050 mid carbon steel blades

GB By-pass lopping shears
D Astschere
PL Sekator do gałęzi
RUSСучкорез
CZ Nožnice zahradnicke
H Ágvágó fix
RO Foarfeca curbata pt. taiat crengi

F Coupe-branches à lame franche
I Cesovia tagliarami
E Podadera para ramas
CN 高枝剪



∅44mm

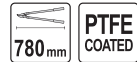

780mm

PTFE COATED



HANGING CARD & POUCH ON BLADE

YATO	L (mm)	
YT-8835	780	12

1050 mid carbon steel blades

GB Anvil lopping shears
D Amboss Astschere
PL Sekator kowadełkowy do gałęzi
RUSСучкорез
CZ Nožnice zahradnicke
H Ágvágó fix
RO Foarfeca curbata pt. taiat crengi

F Coupe-branches à éclume
I Cesovia anvil tagliarami
E Podadera para ramas, de bigornia
CN 高枝剪



∅44mm



770mm

PTFE COATED



HANGING CARD & POUCH ON BLADE

YATO	L (mm)	
YT-8836	770	12

1050 mid carbon steel blades

GB Telescopic by-pass lopping shears
D Astschere
PL Sekator teleskopowy do gałęzi
RUSСекатор с телескопическими ручками
CZ Nožnice zahradnicke
H Ágvágó teleszkópos
RO Foarfeca curbata pt. taiat crengi
F Coupe-branches télescopique
I Cesovia tagliarami telescopica
E Podadera telescópica para ramas
CN 可伸缩高枝剪

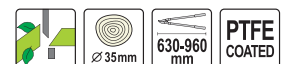

∅35mm

630-960mm

PTFE COATED



HANGING CARD & POUCH ON BLADE

YATO	L (mm)	
YT-8838	630-960	6/12

mid carbon steel blades

GB Telescopic by-pass lopping shears
 D Astschere
 PL Sekator teleskopowy do gałęzi
 RUS Секатор с телескопическими ручками
 CZ Nožnice zahradnicke
 H Ágvágó teleszkópos

RO Foarfeca curbata pt. taiat crengi
 F Coupe-branches télescopique
 I Cesoie tagliarami telescopica
 E Podadera telescópica para ramas
 CN 可伸缩高枝剪

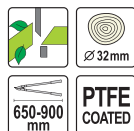

HANGING CARD & POUCH ON BLADE

YATO	L (mm)	
YT-8839	650-900	6

GB Telescopic by-pass lopping shears
 D Astschere
 PL Sekator teleskopowy do gałęzi
 RUS Секатор с телескопическими ручками
 CZ Nožnice zahradnicke
 H Ágvágó teleszkópos

RO Foarfeca curbata pt. taiat crengi
 F Coupe-branches télescopique
 I Cesoie tagliarami telescopica
 E Podadera telescópica para ramas
 CN 可伸缩高枝剪

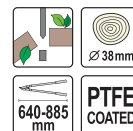

HANGING CARD & POUCH ON BLADE

YATO	L (mm)	
YT-8840	640-885	12

GB Telescopic by-pass lopping shears
 D Astschere
 PL Sekator teleskopowy do gałęzi
 RUS Секатор с телескопическими ручками
 CZ Nožnice zahradnicke
 H Ágvágó teleszkópos

RO Foarfeca curbata pt. taiat crengi
 F Coupe-branches télescopique
 I Cesoie tagliarami telescopica
 E Podadera telescópica para ramas
 CN 可伸缩高枝剪

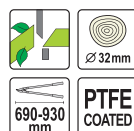

HANGING CARD & POUCH ON BLADE

YATO	L (mm)	
YT-8841	690-930	6

GB Telescopic by-pass lopping shears
 D Astschere
 PL Sekator teleskopowy do gałęzi
 RUS Секатор с телескопическими ручками
 CZ Nožnice zahradnicke
 H Ágvágó teleszkópos

RO Foarfeca curbata pt. taiat crengi
 F Coupe-branches télescopique
 I Cesoie tagliarami telescopica
 E Podadera telescópica para ramas
 CN 可伸缩高枝剪

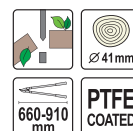

HANGING CARD & POUCH ON BLADE

YATO	L (mm)	
YT-8842	660-910	12

GB Leverage tree pruner
 D Baumsäge mit astschere
 PL Sekator gašienicowy z piłą
 RUS Сучкорез штанговый с пилой
 CZ Stříhač na větve s pilovým listem
 H Kóteles ágvágó
 RO Fierastrau pt. pomí cu prelungitor
 F Système de scie à poulie
 I Taglio pista con sega
 E Podadera de palanca con sierra
 CN 高枝锯



DOUBLE BLISTER



YATO	L (mm)	
YT-8876	325	12

GB Hedge shears
D Heckenschere
PL Nożyce do żywopłotu
RUSКусторезы
CZ Nožnice na živý plot
H Sónényvágó olló

RO Foarfeca pt. gard viu
F Cisaille à haie
I Cesioie per le siepe
E Tijeras para seto vivo
CN 整篱剪



HANGING CARD & POUCH ON BLADE

YATO	L (mm)	
YT-8821	520	24

1050 mid carbon steel blades

GB Hedge shears
D Heckenschere
PL Nożyce do żywopłotu
RUSКусторезы
CZ Nožnice na živý plot
H Sónényvágó olló
RO Foarfeca pt. gard viu

F Cisaille à haie
I Cesioie per le siepe
E Tijeras para seto vivo
CN 整篱剪



HANGING CARD & POUCH ON BLADE

YATO	L (mm)	
YT-8822	550	12

1050 mid carbon steel blades

GB Hedge shears
D Heckenschere
PL Nożyce do żywopłotu
RUSКусторезы
CZ Nožnice na živý plot
H Sónényvágó olló

RO Foarfeca pt. gard viu
F Cisaille à haie
I Cesioie per le siepe
E Tijeras para seto vivo
CN 整篱剪



HANGING CARD & POUCH ON BLADE

YATO	L (mm)	
YT-8823	650	12

1050 mid carbon steel blades

GB Telescopic hedge shears
D Heckenschere
PL Teleskopowe nożyce do żywopłotu
RUSКусторезы с телескопическими ручками
CZ Nožnice na živý plot
H Sónényvágó olló

RO Foarfeca pt. gard viu
F Cisaille télescopique à haie
I Cesioie telescopice per siepe
E Tijeras para seto vivo
CN 可伸缩整篱剪

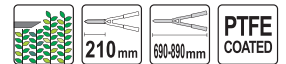

HANGING CARD & POUCH ON BLADE

YATO	L (mm)	
YT-8824	690-890	6

50 mid carbon steel blades

GB Grass shears
D Handgrassschere
PL Nożyce do trawy wielopozycyjne
RUSНожницы для стрижки травы
CZ Nožnice na trávu
H Forgatható fűviró olló

RO Foarfeca pt. gazon
F Cisaille à gazon
I Cesioie per erba multifunzione
E Tijeras de cesped
CN 草剪

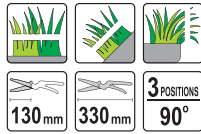

PTFE COATED



TRY ME HALF BLISTER CARD

YATO	L (mm)	
YT-8851	330	12/60

1050 mid carbon steel blades

GB Grass shears
D Handgrassschere
PL Nożyce do trawy wielopozycyjne
RUSНожницы для стрижки травы
CZ Nožnice na trávu
H Forgatható fűviró olló

RO Foarfeca pt. gazon
F Cisaille à gazon
I Cesioie per erba multifunzione
E Tijeras de cesped
CN 草剪

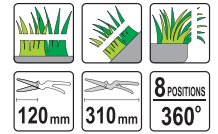

PTFE COATED



TRY ME HALF BLISTER CARD

YATO	L (mm)	
YT-8852	310	6/24

1050 mid carbon steel blades

GB Grass shears
D Handgrassschere
PL Nożyce do trawy wielopozycyjne
RUSНожницы для стрижки травы
CZ Nožnice na trávu
H Forgatható fűviró olló

RO Foarfeca pt. gazon
F Cisaille à gazon
I Cesioie per erba multifunzione
E Tijeras de cesped
CN 草剪

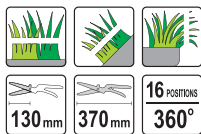

S50C PTFE COATED



TRY ME HALF BLISTER CARD

YATO	L (mm)	
YT-8853	370	6/72

1050 mid carbon steel blades

GB Grass shears
D Handgrassschere
PL Nożyce do trawy wielopozycyjne
RUSНожницы для стрижки травы
CZ Nožnice na trávu
H Forgatható fűviró olló

RO Foarfeca pt. gazon
F Cisaille à gazon
I Cesioie per erba multifunzione
E Tijeras de cesped
CN 草剪

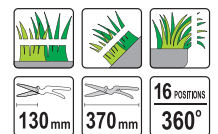

S50C PTFE COATED



TRY ME HALF BLISTER CARD

YATO	L (mm)	
YT-8854	370	6/72

1050 mid carbon steel blades

GB Bow saw
D Bùgelsäge
PL Pila kabląkowa
RUS Лучковая пила
CZ Oblouková pila
H Keretes fűrész

RO Ferăstrău de curbură
F Scie à bûches
I Segã ad arco
E Sierra de arco
CN 两用弓锯

COLOR SLEEVE



HCS 65



2
FUNCTION

FOR WOOD AND METAL
DO DREWNA I METALU

FOR WOOD
DO DREWNA

YATO	L (mm)	
YT-3200	300	12/24

YATO	L (mm)	
YT-3201	450	12/24
YT-3202	530	
YT-3203	610	
YT-3204	760	

GB Blade for dry wood
D Trockenholzsägeblatt für Handsäge
PL Brzeszczot do drewna suchego
RUS Лезвие для работы по сухому дереву
CZ Pilový list na suché dřevo

H Fűrészlap száraz fához
RO Lama pt. lemn uscat
F Lame à bois sec
I Lama per il legno secco
E Hoja de sierra para madera seca
CN 干木锯条

HCS 65

DRY WOOD
DREWNO SUCHE



COLOR SLEEVE

YATO	L (mm)	
YT-3221	450	50/200
YT-3222	530	
YT-3223	610	
YT-3224	760	

GB Blade for wet wood
D Nassholzsägeblatt für Handsäge
PL Brzeszczot do drewna mokrego
RUS Лезвие для работы по влажному дереву
CZ Pilový list na mokré dřevo

H Fűrészlap nedves fához
RO Lama pt. lemn verde
F Lame à bois humide
I Lama per il legno bagnato
E Hoja de sierra para madera mojada
CN 湿木锯条

HCS 65

WET WOOD
DREWNO MOKRE



COLOR SLEEVE

YATO	L (mm)	
YT-3230	300	50/200
YT-3231	450	
YT-3232	530	
YT-3233	610	
YT-3234	760	

GB Axe
D Beil Hicorystiel
PL Siekiera

RUS Tonop
CZ Sekerka
H Szekerce

RO Secure
F Hache
I Ascia

E Hacha
CN 把斧

DIN 5131
7294

GENUINE HICKORY

Timber wedge and steel ring
Drewniany klin ze stalowym pierścieniem

Genuine hickory shaft
Trzonek z hickory



Forged carbon steel head hardened and tempered
Głowica z kutej stali węglowej, hartowana i utwardzona

YATO	m (g)	L (mm)	DIN	
YT-8001	600	360	5131	24
YT-8002	800	380	5131	20
YT-8003	1000	430	5131	12
YT-8004	1250	710	7294	12
YT-8005	1400	710	7294	12
YT-8006	1600	810	7294	12

GB Axe
D Beil Hicorystiel
PL Siekiera

RUS Tonop
CZ Sekerka
H Szekerce

RO Secure
F Hache
I Ascia

E Hacha
CN 把斧

GENUINE HICKORY

Timber wedge and steel ring
Drewniany klin ze stalowym pierścieniem

Genuine hickory shaft
Trzonek z hickory



Forged carbon steel head hardened and tempered
Głowica z kutej stali węglowej, hartowana i utwardzona

YATO	m (g)	L (mm)	
YT-8011	1000	515	6
YT-8012	2000	820	6

GB Transplanter
D Blumenkelle
PL Łopátka
RUS Совок посадочный
CZ Lopatka
H Ásó
RO Mini-lopată gradinarit
F Transplantoir
I Spatola
E Paleta estrecha
CN 移植器

350
mm

CARBON
STEEL



YATO	L (mm)	
YT-8865	350	10/60

GB Rake
D Blumenrechen
PL Grabki
RUS Грабли
CZ Hrabičky
H Gereblye
RO Mini grebla
F Râteau
I Rastrelli
E Rastrillo
CN 园艺耙

325
mm

CARBON
STEEL



YATO	L (mm)	
YT-8866	325	10/60

GB 3-tine fork & rake
D Kleinhacke
PL Motyczka + pazurki
RUS Рыхлитель комбинированный
CZ Motyčka s kultivátorem
H Kapa és kultivátor
RO Sapaliga + cultivator
F Rateau et bêche
I Zappa + artigli
E Escarificador tres
dientes con azadilla
CN 园艺耙

310
mm

CARBON
STEEL



YATO	L (mm)	
YT-8867	310	10/60

GB Cultivator
D Grubber
PL Pazurki
RUS Рыхлитель
CZ Kultivátor
H Kultivátor
RO Cultivator
F Griffe piocheuse
I Artigli
E Escarificador
CN 园艺耙

420
mm

CARBON
STEEL



YATO	L (mm)	
YT-8868	420	10/60

GB Garden rake
D Landschaftsbesen
PL Grabki wachlarzowe
RUS Грабли веерные
CZ Hrabičky
H Kerti gereblye
RO Grebla de gradina
F Râteau
I Rastrelli ventilatore
E Rastrillo de abanico
de hojalata
CN 园艺耙

400
mm

CARBON
STEEL



YATO	L (mm)	
YT-8869	400	10/60

GB Transplanter
D Blumenkelle
PL Łopátka
RUS Совок посадочный
CZ Lopatka
H Ásó
RO Mini-lopată gradinarit
F Transplantoir
I Spatola
E Paleta estrecha
CN 移植器

360
mm

CARBON
STEEL



YATO	L (mm)	
YT-8870	360	10/60

GB Transplanter
D Blumenkelle
PL Łopátka
RUS Совок посадочный
CZ Lopatka
H Ásó
RO Mini-lopată gradinarit
F Transplantoir
I Spatola
E Paleta estrecha
CN 移植器

340
mm

CHROME
PLATED



YATO	L (mm)	
YT-8885	340	12/72

GB Transplanter
D Blumenkelle
PL Łopátka
RUS Совок посадочный
CZ Lopatka
H Ásó
RO Mini-lopată gradinarit
F Transplantoir
I Spatola
E Paleta estrecha
CN 移植器

340
mm

CHROME
PLATED



YATO	L (mm)	
YT-8886	340	12/72

GB Hoe
D Garten handhacke
PL Motyczka
RUS Мотыжка
CZ Motyčka
H Kerti kapa
RO Sapaliga
F Binette
I Zappetta
E Azadilla
CN 园艺锄

280
mm

CHROME
PLATED



YATO	L (mm)	
YT-8889	280	12/72

GB Cultivator
D Grubber
PL Pazurki
RUS Рыхлитель
CZ Kultivátor
H Kultivátor
RO Cultivator
F Griffe piocheuse
I Artigli
E Escarificador
CN 园艺耙

270
mm

CHROME
PLATED



YATO	L (mm)	
YT-8890	270	12/72

GB Rolling tiller
D Rollpflüger
PL Spulchniacz
RUS Рыхлитель дисковый
CZ Kypříč púdy
H Görgös talajlazító
RO Maruntitor pt. pamant
F Émietteur
I Coltivatore
E Escarificador
CN 松土器

370
mm

CHROME
PLATED



YATO	L (mm)	
YT-8891	370	12/72

GB Hoe + cultivator
D Kleinhacke
PL Motyczka z pazurkami
RUS Рыхлитель
комбинированный
CZ Motyčka s hrabičkami
H Kerti villás kapa
RO Sapaliga + cultivator
F Serfouette
I Zappetta con artigli
E Azadilla con
escarificador
CN 园艺锄

320
mm

CHROME
PLATED





YATO	L (mm)	
YT-8892	320	12/72

- GB Dibble
- D Pflanzler
- PL Pikownik ogrodniczy
- RUS Конус посадочный с деревянной ручкой
- CZ Zahradnický přepichovač
- H Kerti palántázó
- RO Chitonag pt. grădină
- F Plantoir
- I Foraterra
- E Picadeor de jardín
- CN 挖洞器



280 mm

STAINLESS STEEL NEROZEWA

YATO 	L (mm)	
YT-8894	280	10/60



- GB Spade
- D Rodespaten
- PL Szpadel
- RUSЗаступ
- CZ Lisovaný rýč kalená
- H Ásó, sajtolt-edzett
- RO Hârleț cu coadă
- F Bêche à bord pointu
- I Spatola
- E Pala
- CN 铲



120 cm

HRC 40-48

1050Mn STEEL

YATO 	L (cm)	
YT-86804	120	6



- GB Spade
- D Rodespaten
- PL Szpadel
- RUSЗаступ
- CZ Lisovaný rýč kalená
- H Ásó, sajtolt-edzett
- RO Hârleț cu coadă
- F Bêche à bord droit
- I Spatola
- E Pala
- CN 铲



120 cm

HRC 40-48

1050Mn STEEL

YATO 	L (cm)	
YT-86800	120	6



- GB Shovel
- D Schaufel
- PL Łopata
- RUSЛопата
- CZ Osazený rýč
- H Homoklapát, ékelt
- RO Lopată pt. nisip
- F Pelle à charbon
- I Palla
- E Pala
- CN 鏟子



120 cm

HRC 40-48

1050Mn STEEL

YATO 	L (cm)	
YT-86801	120	6



- GB Shovel
- D Schaufel
- PL Łopata ogrodnicza
- RUSЛопата совковая песочная
- CZ Osazený rýč pískový
- H Homoklapát, ékelt
- RO Lopată pt. nisip
- F Pelle à sable
- I Palla
- E Pala
- CN 鏟子



120 cm

HRC 40-48



1050Mn STEEL

YATO 	L (cm)	
YT-86808	120	6

- GB Digging fork
- D Profi-grabegabel
- PL Widły
- RUSВилы
- CZ Zahradnické vidlice
- H Vasvilla
- RO Furcă pt. grădinărit
- F Fourche à bêcher
- I Forchetta
- E Horca
- CN 铁叉





120 cm

YATO 	L (cm)	
YT-86805	120	6

- GB Digging fork
- D Profi-grabegabel
- PL Widły
- RUSВилы
- CZ Zahradnické vidlice
- H Vasvilla
- RO Furcă pt. grădinărit
- F Fourche à bêcher
- I Forchetta
- E Horca
- CN 铁叉



120 cm

YATO 	L (cm)	
YT-86809	120	6



GB Cordless chainsaw
D Akku-kettensäge
PL Akumulatorowa pilarka łańcuchowa
RUS Аккумуляторная цепная пила
CZ Akumulátorová řetězová pila
H Akkus lánzfűrész

RO Ferăstrăie cu lanț cu acumulator
F Tronçonneuse
I Motosega a batteria
E Inalámbrico motosierra
CN 无绳链锯

40 V	2.5 Ah	 12" 30.5 cm	 Li-Ion
<small>AUTOMATIC CHAIN LUBRICATION AUTOMATYCZNE SMAROWANIE URUKADU TRZECIO</small>	<small>TOOL-FREE ADJUSTMENT OF CHAIN TENSION BEZKŁUCZKOWY REGULACJA NAPIĘCIA ŁAŃCUCHA</small>	<small>CHARGE LEVEL INDICATOR WSKAZNIK STANU NAŁADOWANIA BATERII</small>	<small>OIL TANK 0.18 l</small>



COLOR BOX

YATO 	V	
YT-85090	40	2

GB Battery
D Akkumulator
PL Akumulator
RUS Аккумулятор
CZ Akumulátor
H Akumulátor
RO Acumulatorul
F Batterie
I Batteria
E Bateria
CN 锂电池



40 V	2.5 Ah	100 Wh	<small>CHARGE LEVEL INDICATOR WSKAZNIK STANU NAŁADOWANIA BATERII</small>	 Li-Ion
----------------	------------------	------------------	--	---



WHITE CARTON BOX & COLOR LABEL



for / dla: YT-85090

YATO 	V	
YT-85132	40	10

GB Battery charger
D Ladegerät
PL Ładowarka
RUS Зарядное устройство
CZ Nabíječka
H Akkutöltő
RO Redresor
F Chargeur de batterie
I Caricabatteria
E Rectificador
CN 充电器

for/dla: 40V	230V~ 50Hz	for/dla:  Li-Ion	1h QUICK CHARGING Szybka ładowanie	
------------------------	----------------------	---	---	---



WHITE CARTON BOX & COLOR LABEL





for / dla: YT-85090,
YT-85132

YATO 	V	
YT-85133	40	18



GB Cordless chainsaw
D Akku-kettensäge
PL Akumulatorowa pilarka łańcuchowa
RUS Аккумуляторная цепная пила
CZ Akumulátorová řetězová pila
H Akkus lánzfűrész

RO Ferăstrăie cu lanț cu acumulator
F Tronçonneuse
I Motosega a batteria
E Inalámbrico motosierra
CN 无绳链锯

18 V	3.0 Ah	 10" 25 cm	 Li-Ion	<small>AUTOMATIC CHAIN LUBRICATION AUTOMATYCZNE SMAROWANIE URUKADU TRZECIO</small>	<small>OIL TANK 0.21 l</small>
----------------	------------------	---	---	--	------------------------------------



COLOR BOX

YATO 	V	
YT-85080	18	2

- GB Cordless pole saw
- D Akku-Hochentaster
- PL Akumulatorowa okrzesywarka na wysięgniku
- RUS Аккумуляторный телескопический высоторез
- CZ Akumulátorová vyvétvovací pila
- H Akumulátoros magassági ágnyeső
- RO Ferăstraie cu lanț cu telescopic
- F Elagueuse sur perche
- I Potatore a batteria
- E Sierra de pértiga telescópica
- CN 高枝锯

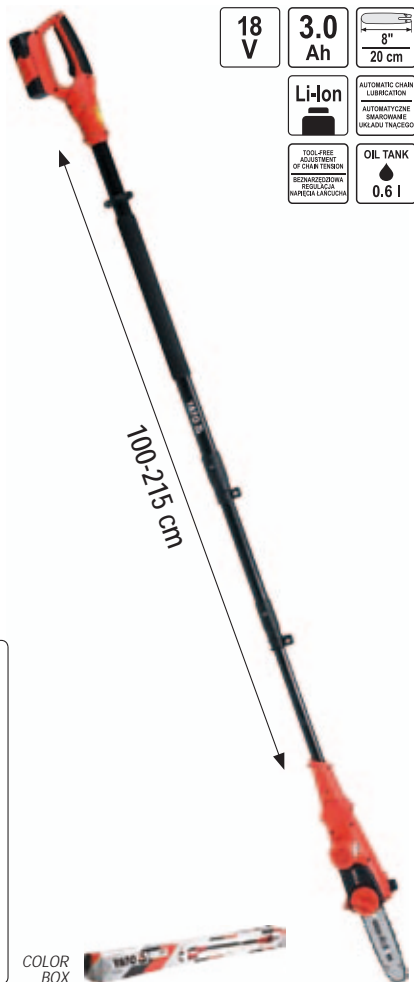

18 V 3.0 Ah 8" 20 cm

Li-Ion

TOOL-FREE ADJUSTMENT OF CHAIN TENSION
BEZPŁATNE DOKŁADNIENIE NAPIĘCIA ŁAŃCZY
MAREKKA ŁAŃCZY

AUTOMATIC CHAIN LUBRICATION
AUTOMATYCZNE SMAROWANIE ŁAŃCZY (TRACED)

OIL TANK 0.6 l

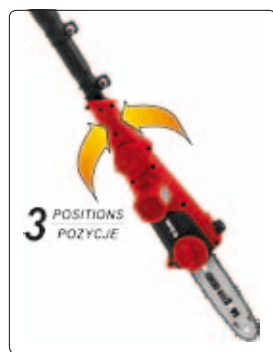

COLOR BOX

YATO	V	
YT-85120	18	2

- GB Cordless grass trimmer
- D Akku-Rasentrimmer
- PL Akumulatorowa podkaszarka do trawy
- RUS Аккумуляторный телескопический высоторез
- CZ Akumulátorová sekačka na trávu
- H Akkus szegélynyíró
- RO Trimmere de gazon cu acumulator
- F Coupe bordures sans fil
- I Tosaerba a filo a batteria
- E Desmalezadora inalámbrico
- CN 打草机

COLOR BOX



18 V 3.0 Ah 8800 min⁻¹ Li-Ion 250mm



YATO	V	
YT-85110	18	4

- GB Cordless hedge trimmer
- D Akku-Heckenschere
- PL Akumulatorowe nożyce do żywoplotu
- RUS Аккумуляторный кусторез
- CZ Akumulátorové nůžky na živé ploty
- H Akkus sövénynyíró
- RO Foarfece de tăiat gard viu cu acumulator
- F Taille-haies sans fil
- I Tagliasiepi a batteria
- E Cortasetos inalámbrico
- CN 充电式修枝剪



18 V 3.0 Ah Li-Ion 2400 min⁻¹ 450mm

COLOR BOX

YATO	V	
YT-85100	18	2

- GB Battery
- D Akkumulator
- PL Akumulator
- RUS Аккумулятор
- CZ Akumulátor
- H Akumulátor
- RO Acumulatorul
- F Batterie
- I Batteria
- E Bateria
- CN 锂电池



18 V 3.0 Ah 54 Wh Li-Ion

WHITE CARTON BOX & COLOR LABEL



for / dla: YT-85080, YT-85100, YT-85110, YT-85120

YATO	V	
YT-85130	18	18

- GB Battery charger
- D Ladegerät
- PL Ładowarka
- RUS Зарядное устройство
- CZ Nabíječka
- H Akkutöltő
- RO Redresor
- F Chargeur de batterie
- I Caricabatteria
- E Rectificador
- CN 充电器



for/dla: 18V 230V~50Hz for/dla: Li-Ion

WHITE CARTON BOX & COLOR LABEL





for / dla: YT-85080, YT-85100, YT-85110, YT-85120, YT-85130

YATO	V	
YT-85131	18	27

- GB Electric chainsaw
D Kettensäge
PL Piłarka elektryczna
RUS Электропила цепная
CZ Elektrická pila
H Elektromos fűrész
RO Ferăstrău cu lanț
F Tronçonneuse électrique
I Motosega elettrica
E Motosierra eléctrica
CN 电链锯





COLOR BOX

YATO 	kW	
YT-84920	2.2	2

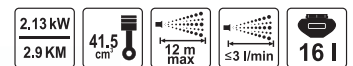
- GB Gasoline backpack sprayer
D Benzin Motorsprüher
PL Opryskiwacz plecakowy spalinowy
RUS Бензиновый ранец-опрыскиватель
CZ Motorový rosič
H Benzines permetező
RO Pulverizatoare pe benzina
F Pulvérisateur à essence
I Atomizzatore
E Pulverizador de gasolina
CN 喷雾喷粉机



WHITE CARTON BOX & COLOR LABEL

YATO 	kW	KM	
YT-85140	2.13	2.9	1

- GB Gasoline chainsaw
- D Motorsägen
- PL Piłarka spalinowa
- RUS Бензопила
- CZ Motorová pila
- H Benzin láncfűrész
- RO Drujba pe benzina
- F Tronçonneuses
- I Motosega a benzina
- E Motosierra de gasolina
- CN 油锯

1.8 kW 2.4 KM	45 cm ³	C max 11000 min ⁻¹	AUTOMATIC CHAIN LUBRICATION AUTOMATYCZNE SMAROWANIE ŁKADZU TRĄCZEGO	ANTI-VIBRATION SYSTEM SYSTEM ANTYWIBRACYJNY	18" 44 cm
+2		0.325" 8.255 mm	0.058" 1.5 mm	OIL TANK 40 : 1 0.26 l	



Matching YATO bars / Pasujące prowadnice z programu YATO: YT-84934, YT-84936
 Matching YATO chains / Pasujące łańcuchy z programu YATO: YT-84940, YT-84941, YT-84942, YT-84943, YT-84944

COLOR BOX



QUICK CHANGE OF AIR FILTER
ŁATWA WYMIANA FILTRA POWIETRZA

YATO	kW	KM	L (mm)	
YT-84900	1.8	2.4	440	1

- GB Gasoline chainsaw
- D Motorsägen
- PL Piłarka spalinowa
- RUS Бензопила
- CZ Motorová pila
- H Benzin láncfűrész
- RO Drujba pe benzina
- F Tronçonneuses
- I Motosega a benzina
- E Motosierra de gasolina
- CN 油锯

2.0 kW 2.7 KM	49.3 cm ³	C max 8500 min ⁻¹	AUTOMATIC CHAIN LUBRICATION AUTOMATYCZNE SMAROWANIE ŁKADZU TRĄCZEGO	ANTI-VIBRATION SYSTEM SYSTEM ANTYWIBRACYJNY	20" 50 cm
+2		0.325" 8.255 mm	0.05" 1.3 mm	OIL TANK 40 : 1 0.26 l	



Matching YATO bars / Pasujące prowadnice z programu YATO: YT-84933
 Matching YATO chains / Pasujące łańcuchy z programu YATO: YT-84945

COLOR BOX





QUICK CHANGE OF AIR FILTER
ŁATWA WYMIANA FILTRA POWIETRZA

YATO	kW	KM	L (mm)	
YT-84905	2.0	2.7	500	1

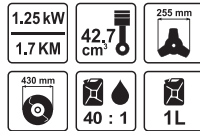
GB Brushcutter
D Motorsensen
PL Kosa spalinowa
RUS Бензокоса
CZ Motorový křovinořez
H Motoros kasza
RO Motocoasa
I Falce fienaiia a benzina
E Motoguadaña de gasolina
CN 割草机



COLOR BOX

YATO 	kW	KM	
YT-85000	1.25	1.7	1

GB Brushcutter
D Motorsensen
PL Kosa spalinowa
RUS Бензокоса
CZ Motorový křovinořez
H Motoros kasza
RO Motocoasa
I Falce fienaiia a benzina
E Motoguadaña de gasolina
CN 割草机

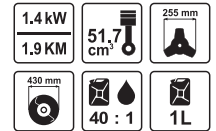



COLOR BOX

YATO 	kW	KM	
YT-85002	1.4	1.9	1

GB Petrol hedge trimmer
D Benzin-Heckenscheren
PL Spalinowe nożyce do żywoplotu
RUS Бензоножницы
CZ Plotostřih na živé ploty
H Benzines sövényvágó
RO Tuns gard viu
F Taille-haie
I Tosasiepi per privati
E Corta sebes a gasolina
CN 绿篱剪



COLOR BOX

YATO 	kW	KM	L (mm)	
YT-85021	0.7	0.99	550	1

GB Chainsaw guide bar
D Kettensägeführung
PL Prowadnica do pił łańcuchowych
RUS Шина для бензопил

CZ Vodičí lišta k řetězové pile
H Láncevezető
RO Lama de ghidai pt. ferastrau
F Guide de tronçonneuse

I Barra per motosega
E Barra guia motosierra
CN 导板

COLOR PAPER POUCH



Mn 65



for / dla: YT-84950, YT-84960

competitors / odpowiedniki: Oregon: 140SPEA074; Alpina: 4112560; Stihl: 3005 000 809; Windsor: 14ST50SSR

for / dla: Alpina: 270, 280, Elletra 160, Elletra 170, Energy 1.6, Energy 1.8, P360, P361, P370, P390, P391, Sinergy 35, Sinergy 40; Oleo-Mac: 240, OEM200; Stihl: 009, 010, 011, 012, 017, 018, 019, 019T, 020, 020T, 021, 021C, 023, 025, 25, MS160, MS170, MS180, MS181, MS191, MS192, MS200, MS200T, MS210, MS211, MS230, MS231, MS241, MS250, MS251, MSE140, MSE200

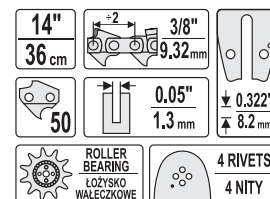

YATO	size / rozmiar	
YT-84930	14" (36 cm)	20



for / dla: YT-84951, YT-84960

competitors / odpowiedniki: Oregon: 140SDEA041; Oleo-mac: 50030218; Husqvarna: 501854149; Windsor: 14PKU50SSR; Makita: 442035661, 472035661, 482035661; Alpina: 4112300; Dolmar: 412035661, 452035661, 462035661; Partner: 530044328

for / dla: Al-Ko: 2000, 2300, 25A, E1200, E125, E1400, E1500, KE3500, VARIO, KE4000, KS, KSB; Alpina: 352, 382, A10E, A14E, E120, E130, E150, ELECTRIC, ES182, ES202, KS1400B, KS1500B; Bosch: 1586, 40-19PRO, AKE30B, AKE30LI, AKE35-19PRO, AKE35B, AKE40B, BULLCRAFT, GKE35BC, GKE40BC, PKE25, PKE30B, PKE35B, PKE40; Dolmar: 100, 101, 102, 103, 104, 105, 106, 108, 275, 285, ES140, ES151, ES152, ES152A, ES153, ES160, ES161, ES162, ES162A, ES163, ES172, ES172A, ES173, ES183, ES2035, ES2040, ES3, ES30, ES37, ES40, ES41, ES6, PS33, PS330, PS3300TH, PS34, PS340, PS341, PS3410, PS344, PS350, PS390, PS400, PS401, PS41, PS45; Echo: CS2600ES, CS260TES, CS2700ES, CS310WES, CS3500ES, CS350WES, CS351WES; Einhell: BG-EC-1840TC, BG-PC-4040, EKS1650, KSE, KSE1435, KSE1635, KSE1640, KSE2000, PES1540, PES1640, PES30, PES34, PES35, PES40, PKS1635, PKS1840, PROF: Hitachi: CS280A, CS280B, CS30EH, CS350A, CS350B, CS35B; Homelite: 20AV, 23AV, 27, 3300, 3335, 350, 3550, 3800, 3850, 4500, 4550, S40, HCS3335, HCS4041CA, PS33, RANGER, TIMBERMAN, UT10901, UT10926, UT10974; Husqvarna: 23, E16, E316, E317, E321, T425; Jonsered: 2033TH; Makita: 5012, 5014, 5016, BUC122RFE, BUC250RDE, DCS232T, DCS300, DCS330S, DCS340, DCS341, DCS3410TH, DCS350, DCS3501, DCS380, DCS390, DCS400, DCS401, DCS4610, EA3201, EA3500F35B, EA3500F40B, UC250DWB, UC3000, UC3030A, UC3500, UC3501, UC3520A, UC3530AK, UC4000, UC4020A, UC4030AK, UC4530A; McCulloch: 10-42, 10-49, 335, 435, 440, 441, 442, 4600, 4700, 4900, 5000, 738, TIMBERBEAR-849, TITAN41, TITAN46; Oleo-Mac: 931, 932, GS35, GS350, GS370, GS410C; Partner: 330, 335, 340, 345, 350, 351, 352, 360, 370, 385, 391, 395, P390, P420, P842; Ryobi: APR02, PCN3335; Skil: 1620U, 1634U, 1636U

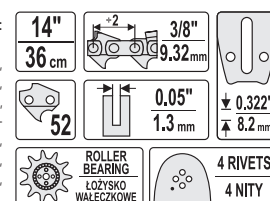

YATO	size / rozmiar	
YT-84931	14" (36 cm)	20



for / dla: YT-84961

competitors / odpowiedniki: Oregon: 158SLHD009; Husqvarna: 508914356; Windsor: 15HS58SPNA

for / dla: Alpina: P660, P680, P700, P750, P800, PROF700, PROF800; Dolmar: PS6400, PS6400H, PS7300, PS7300H, PS7900, PS7900H, PS9000, PS9010; Dolpima: PS190, PS290, PS390, PS490; Echo: CS3500, CS350WES, CS351WE; Husqvarna: 1100, 160, 162, 181, 2100XP, 2101, 2101XP, 260, 266, 268, 272, 281XP, 285, 288XP, 298, 298X, 298XG, 3120, 3120XP, 365, 371, 371XP, 371XPG, 372, 372XP, 372XPG, 380, 385, 385XP, 394, 394XP, 394XPG, 395, 395XP, 395XPG, 480, 562XP, 570, 575, 575XP, 576XP, 61, 64, 65, 66, 70, 77; Jonsered: 1020, 2065, 2071, 2077, 2083, 2094, 2095, 2165, 2171, 2186, 625, 630, 630 SUPER, 670, 670 CHAMP, 820; Makita: DCS6400, DCS6401, DCS7300, DCS7301, DCS7900, DCS79001, DCS9000, DCS9010; Partner: 660, 710, P7700; Solo: 603, 662, 665, 667, 670, 675, 680, 681, 690, 694

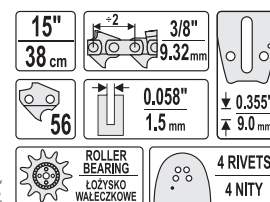

YATO	size / rozmiar	
YT-84932	15" (38 cm)	20



for / dla: YT-84905, YT-84945, YT-84962

competitors / odpowiedniki: Oregon: 50MLBK095; Dolmar: 415038141; Husqvarna: 508926164, 508926364; Makita: 445038141; Windsor: 15CJL50SPYJ

for / dla: Dolmar: 109, 110, 111, 112, 113, 114, 115, 116, PS460, PS4600, PS4605, S500, PS5000, PSS10, PSS100S, PSS40; Husqvarna: 133, 136, 137, 141, 142, 154, 234, 238, 240, 242, 242XP, 246, 254, 257, 261, 262, 339XP, 340, 345, 346, 346XP, 350, 351, 353, 357, 357XP, 359, 36, 40, 41, 42, 435, 435E, 44, 440E, 444, 445, 445E, 45, 450E, 455 RANCHER, 455E RANCHER, 460, 460 RANCHER, 50, 51, 550, 560XP, T435; Jonsered: 2012, 2014, 2015, 2016, 2036, 2040, 2041, 2045, 2050, 2051, 2054, 2055, 2063, 2141, 2145, 2147, 2149, 2150, 2152, 2153, 2155, 2156, 2159, 2163, 370, 380, 410, 420, 425, 435, 45, 450, 451, 451EVS, 452, 455, 490, 495SP, 50, 51, 510, 52, 520, 521, 525, 535, 590, CS2149W, CS2152W; Makita: 45, DCS430, DCS43001, DCS43001, DCS43001, DCS431, DCS460, DCS4600S, DCS500, DCS5000, DCS5030, DCS520, DCS5200I; Oleo-Mac: 850, 938, 940, 941, 942, 942C, 945, 946, 947, 950, 950 Super, 950A, 951, 952, 956, 962 E300F, GS410CX, GS44; Partner: 1200EL, 1400EL, 1450EL, 1500EL, 1650EL, 365, 400, 405, 410, 450, 460, 465, 470, 495, 500, 510, 540, 545, P500, P5000, P5500; Solo: 639, 641, 644, 645, 647, 650, 651, 652, 656, 665

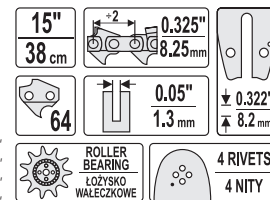

YATO	size / rozmiar	
YT-84933	15" (38 cm)	20



for / dla: YT-84900, YT-84941, YT-84963

competitors / odpowiedniki: Oregon: 158PXBK095; Dolmar: 415038631; Husqvarna: 508912164, 508912364; Makita: 445038631; Solo: 6900343, 6900343K, 6900343N

for / dla: Dolmar: 109, 110, 111, 112, 113, 114, 115, 116, ES1800, PS460, PS4600, PS4605, PS500, PS5000, PS510, PS5100S, PS540; Homelite: 250, 252, 290, 290C, 300, 340, 340C, 3850B, 3850C, 4045, 415B, 444, 4550B, HCS4040, HCS4446CA; Husqvarna: 133, 136, 137, 141, 142, 154, 234, 235, 238, 240, 242, 242XP, 246, 254, 257, 261, 262, 339XP, 340, 345, 346, 346XP, 350, 351, 353, 357, 357XP, 359, 36, 40, 41, 42, 435, 435E, 44, 440, 440E, 444, 445, 445E, 45, 450E, 455 RANCHER, 455E RANCHER, 460, 460 RANCHER, 50, 51, 550, 560XP, T435; Jonsered: 2012, 2014, 2015, 2016, 2036, 2040, 2041, 2045, 2050, 2051, 2054, 2055, 2063, 2141, 2145, 2147, 2149, 2150, 2152, 2153, 2155, 2156, 2159, 2163, 370, 380, 410, 420, 425, 435, 45, 450, 451, 451EVS, 452, 455, 490, 495SP, 50, 51, 510, 52, 520, 521, 525, 535, 590, CS2149W, CS2152W; Makita: 45, DCS430, DCS43001, DCS43001, DCS431, DCS460, DCS4600S, DCS500, DCS5000, DCS5030, DCS520, DCS5200I; NAC: NO-CS38, SPS01-45, SPS01-52, SPS02-45, YD 40/45, YD40, YD52; Oleo-Mac: 850, 938, 940, 941, 942, 942C, 945, 946, 947, 950, 950 Super, 950A, 951, 952, 956, 962 E300F; Partner: 365, 400, 405, 410, 450, 460, 465, 470, 495, 500, 510, 540, 545, P500, P5000, P5500

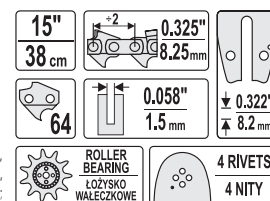

YATO	size / rozmiar	
YT-84934	15" (38 cm)	20

GB Chainsaw guide bar
D Kettensägeführung
PL Prowadnica do pił łańcuchowych
RUS Шина для бензопил

CZ Vodicí lišta k řetězové pile
H Láncevezető
RO Lama de ghidai pt. ferastrau
F Guide de tronçonneuse

I Barra per motosega
E Barra guia motosierra
CN 导板

COLOR
PAPER
POUCH

Mn
65



for / dla: YT-84953, YT-84960

competitors / odpowiedniki: Oregon: 160SDEA041; Oleo-Mac: 50050092; Husqvarna: 530044508; Windsor: 16PKU50SSR; Makita: 442040661, 442040061; Alpina: 4112500; Partner: 530044329

for / dla: Al-Ko: 2000, 2300, 25A, E1200, E125, E1400, E1500, KE3500 VARIO, KE4000, KS, KSB; Alpina: 352, 382, A10E, A14E, E120, E130, E150, ELECTRIC ES182, ES202, KS1400B, KS1500B; Dolmar: 100, 101, 102, 103, 104, 105, 106, 108, 275, 285, ES140, ES151, ES152, ES152A, ES153, ES160, ES161, ES162, ES162A, ES163, ES172, ES172A, ES173, ES183, ES2035, ES2040, ES3, ES30, ES37, ES40, ES41, ES6, PS33, PS330, PS3300TH, PS34, PS340, PS341, PS3410, PS344, PS350, PS390, PS400, PS401, PS41, PS45; Echo: CS2600ES, CS260TES, CS2700ES, CS310WES, CS3500ES, CS350WES, CS351WES, CS360WES; Hitachi: CS280A, CS280B, CS350A, CS350B, CS35B; Homelite: 20AV, 23AV, 27, 3300, 3335, 3350, 3550, 3800, 3850, 4500, 4550, CS40, HCS3335, HCS4041CA, PS33, RANGER, TIMBERMAN, UT10901, UT10926, UT10974; Husqvarna: 23, E16, E316, E317, E321, T425; Jonsered: 2033TH; Makita: 5012, 5014, 5016, BUC122RFE, BUC250RDE, DCS230T, DCS232T, DCS300, DCS300S, DCS330, DCS330S, DCS34, DCS340, DCS341, DCS3410TH, DCS350, DCS3500, DCS3501, DCS3520A, DCS380, DCS390, DCS400, DCS401, DCS4610, UC3000, UC3030A, UC3500, UC3501, UC3520A, UC3530AK, UC4000, UC4030AK; McCulloch: 338, 442; Oleo-Mac: 931, 932, GS35, GS350, GS370, GS410C; Partner: 330, 335, 340, 345, 350, 351, 352, 360, 370, 385, 391, 395, P390, P420, P842; Ryobi: APR02, PCN3335

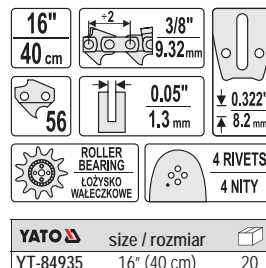

for / dla: YT-84900, YT-84943, YT-84963

competitors / odpowiedniki: Oregon: 188SLGK095; Dolmar: 415045631; Makita: 415045631; Windsor: 18CJL58SPYJ9

for / dla: Dolmar: 109, 110, 111, 112, 113, 114, 115, 116, ES1800, PS460, PS4600, PS4605, PS500, PS5000, PS510, PS5100S, PS540; Homelite: 250, 252, 290, 290C, 300, 340, 340C, 3850B, 3850C, 4045, 415B, 444, 4550B, HCS4040, HCS4446CA; Husqvarna: 133, 136, 137, 141, 142, 154, 234, 238, 240, 242, 242XP, 246, 254, 257, 261, 262, 339XP, 340, 345, 346, 346XP, 350, 351, 353, 357, 357XP, 359, 36, 40, 41, 42, 435, 435E, 44, 440, 440E, 444, 445, 445E, 45, 450E, 455 RANCHER, 455E, RANCHER, 460, 460 RANCHER, 50, 51, 550, 560XP, T435; Jonsered: 2012, 2014, 2015, 2016, 2036, 2040, 2041, 2045, 2050, 2051, 2054, 2055, 2063, 2141, 2145, 2147, 2149, 2150, 2152, 2153, 2155, 2156, 2159, 2163, 370, 380, 410, 420, 425, 435, 45, 450, 451, 451EVS, 452, 455, 490, 495, P50, 51, 510, 52, 520, 521, 525, 535, 590, CS2149W, CS2152W; Makita: 45, DCS430, DCS43001, DCS4300I, DCS431, DCS460, DCS4600S, DCS500, DCS5000, DCS5030, DCS520, DCS5200I; NAC: NO-CS38, SPS01-45, SPS01-52, SPS02-45, YD 40/45, YD40, YD52; Oleo-Mac: 850, 938, 940, 941, 942, 942C, 945, 946, 947, 950, 950 Super, 950A, 951, 952, 956, 962, E300F; Partner: 365, 400, 405, 410, 450, 460, 465, 470, 495, 500, 510, 540, 545, P500, P5000, P5500; Solo: 639, 641, 644, 645, 647, 650, 651, 652, 656, 665

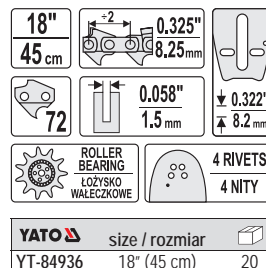

GB Chain for chainsaw
D Kette für Kettensägen
PL Łańcuch tnący do pił
RUS Цепь для бензопилы

CZ Řetěz pro řetězové pily
H Lánclánzfűrész
RO Lant pt. drujba
F Chaîne de tronçonneuse

I Taglio per motoseghea
E Cadena de motosierra
CN 鏈沫

COLOR BOX
WITH EURO HOLE



for / dla: YT-84900

for / dla: Alpina: A40, A40E, P400, P450, P460, P500, P510, P522, PRO540, PRO600, PROF-41, PROF-45; Dolmar: 109, 110, 111, 112, 113, 114, 115i, 116, ES1800, PS460, PS4600, PS4605, PS500, PS5000, PS510, PS5100S, PS540; Echo: CS4200ES, CS4400; Homelite: 250, 252, 290, 290C, 300, 340, 340C, 3850B, 3850C, 415B, 444, 4550B, HCS4040, HCS4045, HCS4446CA; Husqvarna: 133, 136, 137, 140, 141, 142, 154, 234, 235, 238, 240, 240e, 242, 242XP, 246, 254, 254XP, 257, 261, 262, 338XPT, 339XP, 340, 345, 346, 346XP, 350, 351, 353, 357, 357XP, 359, 36, 365, 372XP, 40, 41, 42, 435, 435E, 44, 444, 445, 445E, 45, 450E, 455 RANCHER, 455E RANCHER, 460 RANCHER, 50, 51, 55, T435; Jonsered: 520, 2012, 2014, 2015, 2016, 2036, 2040, 2041, 2045, 2050, 2051, 2054, 2055, 063, 2141, 2145, 2147, 2149, 2150, 2152, 2153, 2155, 2156, 2159, 2163, 370, 380, 410, 420, 425, 435, 45, 450, 451, 451EVS, 452, 455, 490, 495, 50, 51, 510, 52, 521, 525, 535, 590, CS2149W, CS2152W; Makita: 45, DCS430, DCS43001, DCS4300I, DCS431, DCS460, DCS4600S, DCS500, DCS5000, DCS5030, DCS520, DCS5200I; NAC: NO-CS38, SPS01-45, SPS01-52, SPS02-45, YD 40/45, YD40, YD52; Oleo-Mac: 850, 938, 940, 941, 942, 945, 946, 947, 950, 950 Super, 950A, 951, 952, 956, 962, E300F; Partner: 1650, 365, 400, 405, 410, 450, 460, 465, 470, 495, 500, 510, 540, 545, P500, P5000, P5500

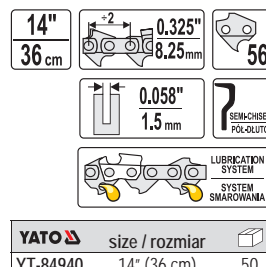

for / dla: YT-84900, YT-84934

for / dla: Dolmar: 109, 110, 111, 112, 113, 114, 115i, 116, ES1800, PS460, PS4600, PS4605, PS500, PS5000, PS5510, PS5100S, PS540; Husqvarna: 154, 257, 440e, 133, 136, 137, 140, 141, 142, 234, 235, 238, 240, 240e, 242, 242XP, 246, 254, 254XP, 261, 262, 338XPT, 339XP, 340, 345, 346, 346XP, 350, 351, 353, 357, 357XP, 359, 36, 365, 372XP, 40, 41, 42, 435, 435E, 44, 444, 445, 445E, 45, 450E, 455 RANCHER, 455E RANCHER, 460 RANCHER, 50, 51, 55, T435; Jonsered: 520, 2012, 2014, 2015, 2016, 2036, 2040, 2041, 2045, 2050, 2051, 2054, 2055, 063, 2141, 2145, 2147, 2149, 2150, 2152, 2153, 2155, 2156, 2159, 2163, 370, 380, 410, 420, 425, 435, 45, 450, 451, 451EVS, 452, 455, 490, 495, 50, 51, 510, 52, 521, 525, 535, 590, CS2149W, CS2152W; Makita: 45, DCS430, DCS43001, DCS4300I, DCS431, DCS460, DCS4600S, DCS500, DCS5000, DCS5030, DCS520, DCS5200I; NAC: NO-CS38, SPS01-45, SPS01-52, SPS02-45, YD 40/45, YD40, YD52; Oleo-Mac: 850, 938, 940, 941, 942, 945, 946, 947, 950, 950 Super, 950A, 951, 952, 956, 962, E300F; Partner: 1650, 365, 400, 405, 410, 450, 460, 465, 470, 495, 500, 510, 540, 545, P500, P5000, P5500

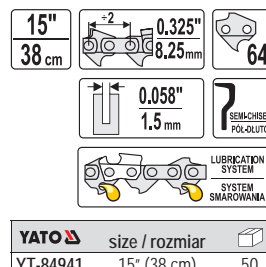

for / dla: YT-84900

for / dla: Dolmar: 109, 110, 111, 112, 113, 114, 115i, 116, ES1800, PS460, PS4600, PS4605, PS500, PS5000, PS5510, PS5100S, PS540; Husqvarna: 154, 257, 440e, 133, 136, 137, 140, 141, 142, 234, 235, 238, 240, 240e, 242, 242XP, 246, 254, 254XP, 261, 262, 338XPT, 339XP, 340, 345, 346, 346XP, 350, 351, 353, 357, 357XP, 359, 36, 365, 372XP, 40, 41, 42, 435, 435E, 44, 444, 445, 445E, 45, 450E, 455 RANCHER, 455E RANCHER, 460 RANCHER, 50, 51, 55, T435; Jonsered: 520, 2012, 2014, 2015, 2016, 2036, 2040, 2041, 2045, 2050, 2051, 2054, 2055, 063, 2141, 2145, 2147, 2149, 2150, 2152, 2153, 2155, 2156, 2159, 2163, 370, 380, 410, 420, 425, 435, 45, 450, 451, 451EVS, 452, 455, 490, 495, 50, 51, 510, 52, 521, 525, 535, 590, CS2149W, CS2152W; Makita: 45, DCS430, DCS43001, DCS4300I, DCS431, DCS460, DCS4600S, DCS500, DCS5000, DCS5030, DCS520, DCS5200I; NAC: NO-CS38, SPS01-45, SPS01-52, SPS02-45, YD 40/45, YD40, YD52; Oleo-Mac: 850, 938, 940, 941, 942, 945, 946, 947, 950, 950 Super, 950A, 951, 952, 956, 962, E300F; Partner: 1650, 365, 400, 405, 410, 450, 460, 465, 470, 495, 500, 510, 540, 545, P500, P5000, P5500

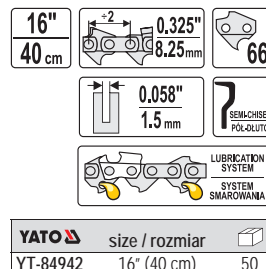

GB Chain for chainsaw
D Kette für Kettensägen
PL Łańcuch tnący do pił
RUS Цепь для бензопилы

CZ Řetěz pro řetězové pily
H Lánca láncfűrész
RO Lant pt. drijba
F Chaîne de tronçonneuse

I Taglio per motoseghea
E Cadena de motosierra
CN 锯沫

COLOR BOX
WITH EURO HOLE



KICKBACK
REDUCTION
ODRZUTU

VIBRATION
REDUCTION
REDUKCJA
WBRACJA

Mn
65



for / dla: YT-84900, YT-84936

for / dla: Dolmar: 109, 110, 111, 112, 113, 114, 115i, 116, ES1800, PS460, PS4600, PS4605, PS500, PS5000, PS5510, PS5100S, PS540; Husqvarna: 154, 257, 440e, 133, 136, 137, 140, 141, 142, 234, 235, 238, 240, 240e, 242, 242XP, 246, 254, 254XP, 261, 262, 338XPT, 339XP, 340, 345, 346, 346XP, 350, 351, 353, 357, 357XP, 359, 36, 365, 372XP, 40, 41, 42, 435, 435E, 44, 444, 445, 445E, 45, 450E, 455 RANCHER, 455E RANCHER, 460 RANCHER, 50, 51, 55, T435; Jonsered: 520, 2012, 2014, 2015, 2016, 2036, 2040, 2041, 2045, 2050, 2051, 2054, 2055, 063, 2141, 2145, 2147, 2149, 2150, 2152, 2153, 2155, 2159, 2163, 370, 380, 410, 420, 425, 435, 45, 450, 451, 451EVS, 452, 455, 490, 495SP, 50, 51, 510, 52, 521, 525, 535, 590, CS2149W, CS2152W; Makita: 45, DCS430, DCS43001, DCS4300I, DCS431, DCS460, DCS4600S, DCS4630, DCS500, DCS5000, DCS5030, DCS5200; NAC: NO-CS38, SPS01-45, SPS01-52, SPS02-45, YD 40/45, YD40, YD52; Oleo-Mac: 850, 938, 940, 941, 942, 945, 946, 947, 950, 950 Super, 950A, 951, 952, 956, 962, E300F; Partner: 1650, 365, 400, 405, 410, 450, 460, 465, 470, 495, 500, 510, 540, 545, P500, P5000, P5500

18" / 45 cm

0.325" / 8.25 mm

72

0.058" / 1.5 mm

SEMICHISEL
POLÓDLUTO

LUBRICATION
SYSTEM
SYSTEM
SMAROWANIA

YATO	size / rozmiar	
YT-84943	18" (45 cm)	50



for / dla: YT-84900

for / dla: Dolmar: 109, 110, 111, 112, 113, 114, 115i, 116, ES1800, PS460, PS4600, PS4605, PS500, PS5000, PS5510, PS5100S, PS540; Husqvarna: 154, 257, 440e, 133, 136, 137, 140, 141, 142, 234, 235, 238, 240, 240e, 242, 242XP, 246, 254, 254XP, 261, 262, 338XPT, 339XP, 340, 345, 346, 346XP, 350, 351, 353, 357, 357XP, 359, 36, 365, 372XP, 40, 41, 42, 435, 435E, 44, 444, 445, 445E, 45, 450E, 455 RANCHER, 455E RANCHER, 460 RANCHER, 50, 51, 55, T435; Jonsered: 520, 2012, 2014, 2015, 2016, 2036, 2040, 2041, 2045, 2050, 2051, 2054, 2055, 063, 2141, 2145, 2147, 2149, 2150, 2152, 2153, 2155, 2159, 2163, 370, 380, 410, 420, 425, 435, 45, 450, 451, 451EVS, 452, 455, 490, 495SP, 50, 51, 510, 52, 521, 525, 535, 590, CS2149W, CS2152W; Makita: 45, DCS430, DCS43001, DCS4300I, DCS431, DCS460, DCS4600S, DCS4630, DCS500, DCS5000, DCS5030, DCS520, DCS5200I; NAC: NO-CS38, SPS01-45, SPS01-52, SPS02-45, YD 40/45, YD40, YD52; Oleo-Mac: 850, 938, 940, 941, 942, 945, 946, 947, 950, 950 Super, 950A, 951, 952, 956, 962, E300F; Partner: 1650, 365, 400, 405, 410, 450, 460, 465, 470, 495, 500, 510, 540, 545, P500, P5000, P5500

20" / 50 cm

0.325" / 8.25 mm

76

0.058" / 1.5 mm

SEMICHISEL
POLÓDLUTO

LUBRICATION
SYSTEM
SYSTEM
SMAROWANIA

YATO	size / rozmiar	
YT-84944	20" (50 cm)	50



for / dla: YT-84905, YT-84933

for / dla: Dolmar: 109, 110, 111, 112, 113, 114, 115i, 116, PS460, PS4600, S4605, PS500, PS5000, PS510, PS5100S, PS540; Husqvarna: 133, 136, 137, 141, 142, 154, 234, 238, 240, 242, 42XP, 246, 254, 254XP, 257, 261, 262, 338XPT, 339XP, 340, 345, 346, 346XP, 350, 351, 353, 357, 357XP, 359, 36, 65, 40, 41, 42, 435, 435E, 44, 440E, 444, 445, 445E, 45, 450E, 455 RANCHER, 460, 460 RANCHER, 50, 51, 55, T435; Jonsered: 2012, 2014, 2015, 2016, 2036, 2040, 2041, 2045, 2050, 051, 2054, 2055, 2063, 2141, 2145, 2147, 2149, 2150, 2152, 2153, 2155, 2156, 2159, 2163, 370, 380, 410, 420, 425, 435, 45, 450, 451, 451EVS, 452, 455, 490, 495SP, 50, 51, 510, 52, 520, 521, 525, 535, 590, CS2149W, CS2152W; Makita: 45, DCS430, DCS43001, DCS4300I, DCS431, DCS460, DCS4600S, DCS4630, DCS500, DCS5000, DCS5030, DCS520, DCS5200I; Oleo-Mac: 850, 938, 940, 941, 941C, 942, 945, 946, 947, 950, 950 Super, 950A, 951, 952, 956, 962, E300F, GS350, GS370, GS410CX; Partner: 1200EL, 1400EL, 1450EL, 1500EL, 1650EL, 365, 400, 405, 410, 450, 460, 465, 470, 495, 500, 510, 540, 545, P500, P5000, P5500

15" / 38 cm

0.325" / 8.25 mm

64

0.05" / 1.3 mm

SEMICHISEL
POLÓDLUTO

LUBRICATION
SYSTEM
SYSTEM
SMAROWANIA

YATO	size / rozmiar	
YT-84945	15" (38 cm)	50



for / dla: Alpina: 270, 280, 330, 380, 432, 438, EURO-40, EURO-45, Elletra 160, Elletra 170, Energy 1.6, Energy 1.8, P360, P370, P390, PR350, Sinergy 35, Sinergy 40; Dolmar: CS2040, PS3300TH; Husqvarna: T425; McCulloch: 3500, 370, 374, 375, 384, 400, 400P, 430, 442, 445, 470, 474, 484, 838, 839, ELECTRA MAC 16E, MAC110, MAC120, MAC130, MAC140, MAC4, MAC6, MAC90, MAC935, MC115, MM30, MM36, PM310, PM320, PM330, PM340, PM36, PM360, PM364, PM370, PM380, PM394, PM400, M470, PM480, PM484, PM510, PM730; Oleo-Mac: 240, OEM200; Partner: 1535EL, 1540, 1540EL, 1640, 1835, 1840, 352, 371, 391, 538E, 542E, P1535, P351; Stihl: 009, 010, 011, 012, 017, 018, 019, 019T, 020, 020T, 021, 021C, 023, 025, 25, MS160, MS170, MS180, MS181, MS191, MS192, MS200, MS200T, MS210, MS211, MS230, MS231, MS241, MS250, MS251, MSE140, MSE200

14" / 36 cm

3/8" / 9.32 mm

50

0.05" / 1.3 mm

SEMICHISEL
POLÓDLUTO

YATO	size / rozmiar	
YT-84950	14" (36 cm)	50



for / dla: YT-84931

for / dla: Al-Ko: 2000, 2300, 25A, E1200, E125, E1400, E1500, KE3500 VARIO, KE4000, KS, KSB; Alpina: 352, 382, A10E, A14E, E120, E130, E150, ELECTRIC, ES182, ES202, KS1400B, KS1500B; Dolmar: 100, 101, 102, 103, 104, 105, 106, 108, 275, 285, CS2040E, S140, ES151, ES152, ES152A, ES153, ES160, ES161, ES162, ES162A, ES163, ES172, ES172A, ES173, ES183, ES2035, ES2040, ES3, ES30, ES37, ES40, ES41, ES6, PS33, PS330, PS3300TH, PS330TH, PS34, PS340, PS341, PS3410, PS344, PS350, PS390, PS400, PS401, PS41, PS45; Echo: CS2600ES, CS260TES, CS2700ES, CS3500ES, CS3500ES, CS3500ES, CS3500ES, CS3510ES; Hitachi: CS280A, CS280B, CS350A, CS350B, CS35B; Homelite: 20AV, 23AV, 27, 3300, 3335, 3350, 3550, 3800, 4500, 4550, CS40, HCS3335, HCS4041CA, PS33, RANGER, TIMBERMAN, UT10901, UT10926, UT10974; Husqvarna: 136, 137, 1400, 141, 142, 16, 1600, 23, 243, 315, 316, 318, 320, 321, 33, 333, 334, 335XPT, 338, 338XPT, 36, 41, E16, E316, E317, E321, T425; Jonsered: 2033TH, 2035, 2115, 2115EL, 2116, 2117, 2118EL, 2121, 2135, 2137, 2138, 2139; Makita: 5012, 5016, BUC122RFE, BUC250RDE, DCS230T, DCS232T, DCS300, DCS300S, CS330, DCS330S, DCS34, DCS340, DCS341, DCS3410TH, DCS350, DCS3500, DCS3501, DCS3520A, DCS380, DCS390, DCS400, DCS401, DCS4610, UC3000, UC3030A, UC3500, UC3501, UC3520A, UC3530AK, UC4000, UC4030AK; McCulloch: MS1215, MS1415, MS1425, MS1435, MS1630, MS1635AV, MS1640, MS1645, MS1834N, MS1845J; Oleo-Mac: 931, 932, GS35, GS350, GS370; Partner: 330, 335, 340, 345, 350, 351, 360, 370, 385, 391, 395, P390, P420, P842; Ryobi: APR02, PCN33351

14" / 36 cm

3/8" / 9.32 mm

52

0.05" / 1.3 mm

SEMICHISEL
POLÓDLUTO

YATO	size / rozmiar	
YT-84951	14" (36 cm)	50



for / dla: YT-84935

for / dla: Al-Ko: 2000, 2300, 25A, E1200, E125, E1400, E1500, KE3500 VARIO, KE4000, KS, KSB; Alpina: 352, 382, A10E, A14E, E120, E130, E150, ELECTRIC, ES182, ES202, KS1400B, KS1500B; Dolmar: 100, 101, 102, 103, 104, 105, 106, 108, 275, 285, CS2040E, S140, ES151, ES152, ES152A, ES153, ES160, ES161, ES162, ES162A, ES163, ES172, ES172A, ES173, ES183, ES2035, ES2040, ES3, ES30, ES37, ES40, ES41, ES6, PS33, PS330, PS3300TH, PS330TH, PS34, PS340, PS341, PS3410, PS344, PS350, PS390, PS400, PS401, PS41, PS45; Echo: CS2600ES, CS260TES, CS2700ES, CS3500ES, CS3500ES, CS3510ES; Hitachi: CS280A, CS280B, CS350A, CS350B, CS35B; Homelite: 20AV, 23AV, 27, 3300, 3335, 3350, 3550, 3800, 4500, 4550, CS40, HCS3335, HCS4041CA, PS33, RANGER, TIMBERMAN, UT10901, UT10926, UT10974; Husqvarna: 136, 137, 1400, 141, 142, 16, 1600, 23, 243, 315, 316, 318, 320, 321, 33, 333, 334, 335XPT, 338, 338XPT, 36, 41, E16, E316, E317, E321, T425; Jonsered: 2033TH, 2035, 2115, 2115EL, 2116, 2117, 2118EL, 2121, 2135, 2137, 2138, 2139; Makita: 5012, 5016, BUC122RFE, BUC250RDE, DCS230T, DCS232T, DCS300, DCS300S, CS330, DCS330S, DCS34, DCS340, DCS341, DCS3410TH, DCS350, DCS3500, DCS3501, DCS3520A, DCS380, DCS390, DCS400, DCS401, DCS4610, UC3000, UC3030A, UC3500, UC3501, UC3520A, UC3530AK, UC4000, UC4030AK; McCulloch: MS1215, MS1415, MS1425, MS1435, MS1630, MS1635AV, MS1640, MS1645, MS1834N, MS1845J; Oleo-Mac: 931, 932, GS35, GS350, GS370; Partner: 330, 335, 340, 345, 350, 351, 360, 370, 385, 391, 395, P390, P420, P842; Ryobi: APR02, PCN3335

16" / 40 cm

3/8" / 9.32 mm

56

0.05" / 1.3 mm

SEMICHISEL
POLÓDLUTO

YATO	size / rozmiar	
YT-84953	16" (40 cm)	50

GB Chain for chainsaw
D Kette für Kettensägen
PL Łańcuch łańcuch do pił
RUS Цепь для бензопилы

CZ Řetěz pro řetězové pily
H Lānc lāncfūrész
RO Lant pt. drujba
F Chaîne de tronçonneuse

I Taglio per motoseghea
E Cadena de motosierra
CN 蠟沫

COLOR BOX
WITH EURO HOLE



for / dla: YT-84935

for / dla: Al-Ko: 2000, 2300, 25A, E1200, E125, E1400, E1500, KE3500 VARIO, KE4000, KS, KSB; Alpina: 352, 382, A10E, A14E, E120, E130, E150, ELECTRIC, ES182, ES202, KS1400B, KS1500B; Dolmar: 100, 101, 102, 103, 104, 105, 106, 108, 275, 285, CS2040, ES140, ES151, ES152, ES152A, ES153, ES160, ES161, ES162, ES162A, ES163, ES172, ES172A, ES173, ES183, ES2035, ES2040, ES3, ES30, ES37, ES40, ES41, ES6, PS33, PS330, PS3300TH, PS330TH, PS34, PS340, PS341, PS3410, PS344, PS350, PS390, PS400, PS401, PS41, PS45; Echo: CS2600ES, CS260TES, CS2700ES, CS3500ES, CS350WES, CS351WES; Hitachi: CS280A, CS280B, CS350A, CS350B, CS35B; Homelite: 20AV, 23AV, 27, 3300, 3335, 3350, 3550, 3800, 4500, 4550, CS40, HCS3335, HCS4041CA, PS33, RANGER, TIMBERMAN, UT10901, UT10926, UT10974; Husqvarna: 23, E16, E316, E317, E321, T425; Jonsered: 2033TH; Makita: 5012, 5016, BUC122RFE, BUC250RDE, DCS230T, DCS232T, DCS300, DCS300S, DCS330, DCS330S, DCS34, DCS340, DCS341, DCS3410TH, DCS350, DCS3500, DCS3501, DCS3520A, DCS380, DCS390, DCS400, DCS401, DCS4610, UC3000, UC3030A, UC3500, UC3501, UC3520A, UC3530AK, UC4000, UC4030AK; Oleo-Mac: 931, 932, GS35, GS350, GS370; Partner: 330, 335, 340, 345, 350, 351, 370, 385, 395, P390, P420; Ryobi: APR02, PCN3335

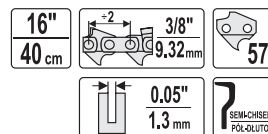

YATO	size / rozmiar	
YT-84954	16" (40 cm)	50



for / dla: Stihl: 029, 031, 032, 034, 036, 038, 039, 041, 042, 044, 045, 046, 048, 056, 064, 066, E15, E20, E220, MS200, MS220, MS290, MS310, MS311, MS340, MS341, MS361, MS362, MS390, MS440, MS441, MS460, MS650, MS660, MS880, MSE200, MSE220

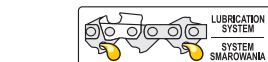
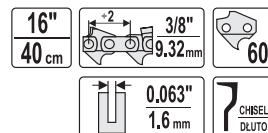

YATO	size / rozmiar	
YT-84955	16" (40 cm)	50

GB Chain for chainsaw
D Kette für Kettensägen
PL Łańcuch łańcuch do pił
RUS Цепь для бензопилы

CZ Řetěz pro řetězové pily
H Lānc lāncfūrész
RO Lant pt. drujba
F Chaîne de tronçonneuse

I Taglio per motoseghea
E Cadena de motosierra
CN 蠟沫

PAPER SPOOL & COLOR LABEL
PLUS 30 PCS OF ADDITIONAL
COLOR BOXES & POLYBAGS



+30 PCS



for / dla: YT-84930, YT-84931, YT-84935

for / dla: Alpina: 270, 280, 330, 380, 432, 438, EURO-40, EURO-45, Elletra 160, Elletra 170, Energy 1.6, Energy 1.8, P360, P370, P390, PR350, Sinergy 35, Sinergy 40; Dolmar: CS2040, PS3300TH; Husqvarna: T425; McCulloch: 3500, 370, 374, 375, 384, 400, 400P, 430, 442, 445, 470, 474, 484, 838, 839, ELECTRA MAC 16E, MAC110, MAC120, MAC130, MAC140, MAC4, MAC6, MAC930, MAC935, MC115, MM30, MM36, PM310, PM320, PM330, PM340, PM36, PM360, PM364, PM370, PM380, PM394, PM400, M470, PM480, PM484, PM510, PM730; Oleo-Mac: 240, OEM200; Partner: 1535EL, 1540, 1540EL, 1640, 1835, 1840, 352, 371, 391, 538E, 542E, P1535, P351; Stihl: 009, 010, 011, 012, 017, 018, 019, 019T, 020, 020T, 021, 021C, 023, 025, 25, MS160, MS170, MS180, MS181, MS191, MS192, MS200, MS200T, MS210, MS211, MS230, MS231, MS241, MS250, MS251, MSE140, MSE200

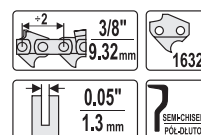

YATO		
YT-84960		1

for / dla: YT-84932

for / dla: Alpina: P700, P750, P800, PROF700, PROF800; Dolmar: 115, 117, 119, 120, 120SI, 122, 123, 1231, 133, 143, 152, 153, 186, 219, CA, KMS4, PS43, PS6000I, PS6000IH, PS6400, PS6400H, PS6800I, PS6800IH, PS7300, PS7300H, PS7900, PS7900H, PS9000, PS9010; Echo: CS3500, CS350WES, CS351WE; Husqvarna: 1100, 154, 160, 162, 181, 2100XP, 2101, 2101XP, 254, 257, 260, 261, 262, 266, 268, 272, 281XP, 285, 288XP, 298, 298X, 298XG, 3120, 3120XP, 357, 357XP, 359, 362, K34365, 371, 371XP, 371XPG, 372, 372XP, 372XPG, 380, 385, 385XP, 394, 394XP, 394XPG, 395, 395XP, 395XPG, 455, 480, 55, 560XP, 562XP, 570, 575, 575XP, 576XP, 61, 64, 65, 66, 70, 77; Jonsered: 1020, 2063, 2065, 2071, 2077, 2083, 2094, 2095, 2159, 2163, 2165, 2171, 2186, 625, 630, 630 SUPER, 670, 670 CHAMP, 820; Makita: DCS460, DCS4600, DCS500, DCS5030, DCS6400, DCS6401, DCS7301, DCS79001, DCS9000, DCS9010; Oleo-Mac: 250A, 251, 252, 254, 261, 264, 271, 272, 284, 350, 355, 460, 480, 481, 482, 484, 970, 971, 980, 981, E300; Partner: 550, 660, 710, P770

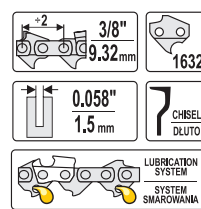

YATO		
YT-84961		1

GB Chain for chainsaw
D Kette für Kettenmägen
PL Łańcuch tnący do pił
RUS Цепь для бензопилы

CZ Řetěz pro řetězové pily
H Láncláncfűrész
RO Lant pt. drijba
F Chaîne de tronçonneuse

I Taglio per motoseghea
E Cadena de motosierra
CN 鋸沫

PAPER SPOOL & COLOR LABEL
PLUS 30 PCS OF ADDITIONAL
COLOR BOXES & POLYBAGS



KICKBACK REDUCTION REDUKCJA ODRZUTU	VIBRATION REDUCTION REDUKCJA WIBRACJI
Mn 65	30 SPARE LINKS ZAPASOWYCH OGNIV

for / dla: YT-84905; YT-84933

for / dla: Dolmar: 109, 110, 111, 112, 113, 114, 115i, 116, PS460, PS4600, S4605, PS500, PS5000, PS510, PS5100S, PS540; Husqvarna: 133, 136, 137, 141, 142, 154, 234, 238, 240, 242, 42XP, 246, 254, 254XP, 257, 261, 262, 338XPT, 339XP, 340, 345, 346, 346XP, 350, 351, 353, 357, 357XP, 359, 36, 65, 40, 41, 42, 435, 435E, 44, 440E, 444, 445, 445E, 45, 450E, 455 RANCHER, 455E RANCHER, 460, 460 RANCHER, 50, 51, 55, T435; Jonsered: 2012, 2014, 2015, 2016, 2036, 2040, 2041, 2045, 2050, 051, 2054, 2055, 2063, 2141, 2145, 2147, 2149, 2150, 2152, 2153, 2155, 2156, 2159, 2163, 370, 380, 410, 420, 425, 435, 45, 450, 451, 451EVS, 452, 455, 490, 49SP, 50, 51, 510, 52, 520, 521, 525, 535, 590, CS2149W, CS2152W; Makita: 45, DCS430, DCS43001, DCS43001, DCS431, DCS460, DCS4600S, DCS4630, DCS500, DCS5000, DCS5030, DCS520, DCS52001; Oleo-Mac: 850, 938, 940, 941, 941C, 942, 945, 946, 947, 950, 950 Super, 950A, 951, 952, 956, 962, E300F, GS350, GS370, GS410CX; Partner: 1200EL, 1400EL, 1450EL, 1500EL, 1650EL, 365, 400, 405, 410, 450, 460, 465, 470, 495, 500, 510, 540, 545, P500, P5000, P5500



0.325" 8.25mm	1846
0.05" 1.3mm	SEMI-CHESEL POL-DUTO
LUBRICATION SYSTEM SYSTEM SMAROWANIA	

YATO	
YT-84962	1

for / dla: YT-84900; YT-84934, YT-84936

for / dla: Dolmar: 109, 110, 111, 112, 113, 114, 115i, 116, ES1800, PS460, PS4600, PS4605, PS500, PS5000, PS5510, PS5100S, PS540; Husqvarna: 154, 257, 440e, 133, 136, 137, 140, 141, 142, 234, 235, 238, 240, 240e, 242, 242XP, 246, 254, 254XP, 261, 262, 338XPT, 339XP, 340, 345, 346, 346XP, 350, 351, 353, 357, 357XP, 359, 36, 365, 372XP, 40, 41, 42, 435, 435E, 44, 444, 445, 445E, 45, 450E, 455 RANCHER, 455E RANCHER, 460 RANCHER, 50, 51, 55, T435; Jonsered: 520, 2012, 2014, 2015, 2016, 2036, 2040, 2041, 2045, 2050, 2051, 2054, 2055, 063, 2141, 2145, 2147, 2149, 2150, 2152, 2153, 2155, 2156, 2159, 2163, 370, 380, 410, 420, 425, 435, 45, 450, 451, 451EVS, 452, 455, 490, 49SP, 50, 51, 510, 52, 521, 525, 535, 590, CS2149W, CS2152W; Makita: 45, DCS430, DCS43001, DCS431, DCS460, DCS4600S, DCS4630, DCS500, DCS5000, DCS5030, DCS520, DCS52001; NAC: NO-CS38, SPS01-45, SPS01-52, SPS02-45, YD 40/45, YD40, YD52; Oleo-Mac: 850, 938, 940, 941, 942, 945, 946, 947, 950, 950 Super, 950A, 951, 952, 956, 962, E300F; Partner: 1650, 365, 400, 405, 410, 450, 460, 465, 470, 495, 500, 510, 540, 545, P500, P5000, P5500



0.325" 8.25mm	1846
0.058" 1.5mm	SEMI-CHESEL POL-DUTO
LUBRICATION SYSTEM SYSTEM SMAROWANIA	

YATO	
YT-84963	1

GB Chainsaw chain spinner

D Sägekette nietgerät
PL Nitownica do łańcuchów do pilarek
RUS Станок для клепания цепей
CZ Nitovačka pilových řetězů
H Szegecselő készülék fűrészlánchoz
RO Masina de nituit lanturi si de spart lanturi
F Riveteuse d'établi pour chaînes de tronçonneuses
I Catena spinner
E Remachadora banco cadenas de motosierra
CN 鋸沫

1/4" - 0.404" 6.35 - 10.26mm
1.1 ~ 2.1mm

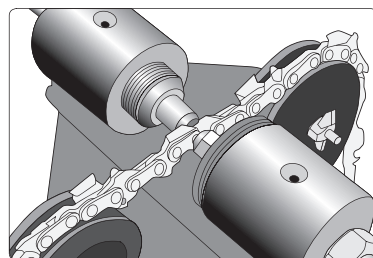

COLOR BOX



YATO	
YT-84970	6

GB Chainsaw chain breaker

D Sägeketten Entnietgerät
PL Rozkuwarka do łańcuchów pilarek
RUS Станок для расклепки цепей
CZ Roznitovačka pilových řetězů
H Szegecskinymó fűrészlánchoz
RO Masina spart lant drijba
F Deriveteuse chaîne de tronçonneuse
I Catena breaker
E Rompe cadenas de motosierra
CN 鋸沫

1/4" 0.325" 3/8" 0.404" 6.35mm 8.25mm 9.52mm 10.26mm	90-91
---	-------



COLOR BOX



YATO	
YT-84971	6

YATO	page/strona	YATO	page/strona	YATO	page/strona	YATO	page/strona	YATO	page/strona	YATO	page/strona	YATO	page/strona	YATO	page/strona	YATO	page/strona
YT-0006	7	YT-0128	11	YT-02333	13	YT-0354	6	YT-04303	74	YT-04395	75	YT-0503	112	YT-05615	110	YT-0638	330
YT-0007	7	YT-0132	11	YT-02334	13	YT-0355	6	YT-04304	74	YT-04396	75	YT-0504	112	YT-0562	113	YT-0640	324
YT-0008	7	YT-0135	16	YT-0248	13	YT-0356	6	YT-04305	74	YT-04397	75	YT-0505	112	YT-0563	113	YT-0641	324
YT-0009	7	YT-0136	16	YT-0250	13	YT-0357	6	YT-04306	74	YT-04398	75	YT-0506	112	YT-0585	327	YT-0642	330
YT-0010	7	YT-0137	16	YT-0252	13	YT-0358	6	YT-04307	74	YT-04401	75	YT-0507	112	YT-0590	326	YT-0643	361
YT-0011	7	YT-0138	16	YT-0290	27	YT-0359	6	YT-04310	74	YT-04411	74	YT-0508	112	YT-0591	326	YT-0645	337
YT-0012	7	YT-01385	16	YT-0291	32	YT-0360	6	YT-04311	74	YT-04412	74	YT-0509	112	YT-0593	91; 353	YT-0646	338
YT-0013	7	YT-0139	16	YT-0292	38	YT-0362	6	YT-04312	74	YT-04413	74	YT-0511	113	YT-0594	316	YT-0647	338
YT-0014	7	YT-0140	16	YT-0293	27	YT-0363	6	YT-04313	74	YT-04417	74	YT-0512	113	YT-0595	315	YT-06475	340
YT-0015	7	YT-0143	16	YT-0294	32	YT-0365	6	YT-04314	74	YT-04418	74	YT-0519	113	YT-0596	316	YT-0648	339
YT-0016	7	YT-0150	11	YT-0295	38	YT-0367	11	YT-04315	74	YT-0459	106	YT-0520	71	YT-0598	317	YT-0650	338
YT-0017	7	YT-0152	11	YT-0297	28	YT-0368	11	YT-04316	74	YT-0461	76	YT-0521	71	YT-0599	317	YT-0651	338
YT-0018	7	YT-0156	10	YT-0298	33	YT-0369	11	YT-04317	74	YT-0465	108	YT-05211	71	YT-0600	317	YT-0652	338
YT-0019	7	YT-0158	10	YT-0299	39	YT-0370	11	YT-04318	74	YT-0466	108	YT-05212	71	YT-0601	341	YT-0653	339
YT-0020	7	YT-0162	10	YT-0307	27	YT-0371	11	YT-04319	74	YT-0467	108	YT-05213	71	YT-06011	341	YT-0657	336
YT-0021	7	YT-0163	10	YT-0308	31	YT-0372	11	YT-04320	75	YT-0468	108	YT-05214	71	YT-06012	342	YT-0659	334
YT-0022	7	YT-0170	16	YT-0309	38	YT-0373	11	YT-04321	75	YT-0470	105	YT-05215	71	YT-06013	343	YT-06590	334
YT-0023	7	YT-0171	16	YT-0310	27	YT-0374	11	YT-04322	75	YT-04702	104	YT-05220	71	YT-06014	342	YT-0660	363
YT-0024	7	YT-0172	16	YT-0311	31	YT-0375	11	YT-04323	75	YT-0471	105	YT-05221	71	YT-06015	344	YT-0661	364
YT-0025	7	YT-0173	16	YT-0312	38	YT-0376	11	YT-04324	75	YT-04712	104	YT-05222	71	YT-06016	343	YT-06611	364
YT-0026	7	YT-0175	16	YT-0313	27	YT-0377	11	YT-04325	75	YT-0472	105	YT-05223	71	YT-06017	344	YT-0662	364
YT-0027	7	YT-0184	17	YT-0314	31	YT-0378	11	YT-04326	75	YT-04722	104	YT-05224	71	YT-06019	341	YT-0663	363
YT-0028	7	YT-0187	17	YT-0315	38	YT-0380	11	YT-04327	75	YT-0473	105	YT-05225	71	YT-0602	323	YT-0670	348
YT-0030	7	YT-0189	9	YT-0316	27	YT-0381	11	YT-04328	75	YT-0474	105	YT-05226	71	YT-0603	326	YT-0671	357
YT-0032	7	YT-0190	17	YT-0317	31	YT-0383	12	YT-04329	75	YT-04742	104	YT-05227	71	YT-0604	355	YT-0672	351
YT-0036	7	YT-01906	9	YT-0318	38	YT-0384	12	YT-04331	75	YT-0475	105	YT-05228	71	YT-0605	359	YT-06722	378
YT-0038	7	YT-01907	9	YT-0319	27	YT-0385	12	YT-04332	75	YT-04752	104	YT-0530	18	YT-0606	336	YT-0673	352
YT-0041	7	YT-01908	9	YT-0320	31	YT-0386	12	YT-04341	74	YT-0476	105	YT-0534	353	YT-0607	336	YT-0674	352
YT-0046	7	YT-01909	9	YT-0321	38	YT-0387	12	YT-04342	74	YT-04762	104	YT-0539	340	YT-0608	336	YT-0677	339
YT-0050	7	YT-0191	9	YT-0322	27	YT-0388	12	YT-04343	74	YT-0477	105	YT-0540	340	YT-0609	323	YT-06771	385
YT-0055	7	YT-0192	9	YT-0323	31	YT-0389	12	YT-04344	74	YT-04772	104	YT-05571	109	YT-0610	355	YT-06772	382
YT-0060	7	YT-0193	9	YT-0324	38	YT-0390	12	YT-04345	74	YT-0478	105	YT-05572	109	YT-0611	356	YT-06773	382
YT-0062	7	YT-0194	9	YT-0325	27	YT-0391	12	YT-04346	74	YT-04782	104	YT-05574	109	YT-0612	328	YT-06774	382
YT-0065	7	YT-0195	9	YT-0326	32	YT-0392	12	YT-04350	75	YT-0479	105	YT-05576	109	YT-06122	328	YT-06775	382
YT-0067	7	YT-0196	9	YT-0327	38	YT-0394	12	YT-04351	75	YT-04792	104	YT-05577	109	YT-0613	328	YT-06776	383
YT-0075	7	YT-0197	9	YT-0331	28	YT-0396	12	YT-04352	75	YT-0480	105	YT-05578	109	YT-0614	328	YT-06777	390
YT-00760	6	YT-0198	9	YT-03311	28	YT-0398	12	YT-04353	75	YT-0481	105	YT-05579	109	YT-0615	328	YT-06780	384
YT-00761	6	YT-0199	9	YT-03315	39; 228	YT-0400	107	YT-04354	75	YT-04812	104	YT-05581	109	YT-06155	329	YT-06782	388
YT-00762	6	YT-0200	9	YT-03316	39; 228	YT-0404	103	YT-04355	75	YT-0482	105	YT-05583	110	YT-06157	329	YT-06785	390
YT-00763	6	YT-0201	9	YT-0332	11	YT-0405	103	YT-04356	75	YT-04822	104	YT-05585	109	YT-0616	330	YT-06786	385
YT-00764	6	YT-0202	9	YT-0333	11	YT-04051	103	YT-04357	75	YT-0483	105	YT-05586	109	YT-06160	328	YT-06787	388
YT-00765	6	YT-0203	9	YT-0334	11	YT-04052	103	YT-04360	75	YT-04832	104	YT-05588	109	YT-0617	345	YT-06790	389
YT-00766	6	YT-0204	9	YT-0335	6	YT-0406	103	YT-04370	74	YT-0484	106	YT-05590	109	YT-0618	345	YT-0680	355
YT-00767	6	YT-0205	9	YT-0336	6	YT-0407	103	YT-04371	74	YT-0485	103	YT-05591	109	YT-0619	360	YT-0681	356
YT-00768	6	YT-0206	9	YT-0337	6	YT-0408	103	YT-04372	74	YT-0486	103	YT-05592	109	YT-0620	327	YT-0682	357
YT-00769	6	YT-0207	13	YT-0338	6	YT-0409	103	YT-04373	74	YT-0487	103	YT-05593	109	YT-06205	337	YT-06822	358
YT-0107	11	YT-0208	9	YT-0339	6	YT-0410	107	YT-04374	74	YT-0488	106	YT-05594	109	YT-0621	360	YT-0683	355
YT-0109	11	YT-0209	13	YT-0340	6	YT-0411	107	YT-04375	74	YT-0489	106	YT-05597	110	YT-0622	347	YT-0684	354
YT-0110	11	YT-0211	13	YT-0341	6	YT-0412	107	YT-04381	74	YT-0490	106	YT-0560	113	YT-0623	327	YT-0685	354
YT-0111	11	YT-0213	13	YT-0342	6	YT-0413	107	YT-04382	74	YT-0491	106	YT-05601	109	YT-0624	327	YT-0686	354
YT-0112	11	YT-0215	13	YT-0343	6	YT-0414	107	YT-04383	74	YT-0492	106	YT-05602	109	YT-06251	328	YT-06864	384
YT-0113	11	YT-0217	13	YT-0344	6	YT-0415	107	YT-04384	74	YT-0493	106	YT-05603	109	YT-0627	340	YT-06865	383
YT-0115	11	YT-0219	13	YT-0345	6	YT-0416	107	YT-04385	74	YT-0494	106	YT-05604	109	YT-06273	340	YT-06866	151; 392
YT-0117	11	YT-0222	13	YT-0346	6	YT-0417	107	YT-04386	74	YT-0495	106	YT-05605	109	YT-0628	360	YT-06868	151; 392
YT-0118	11	YT-0223	13	YT-0347	6	YT-0418	107	YT-04387	74	YT-0496	106	YT-05606	109	YT-0630	336	YT-06870	151; 392
YT-0119	11	YT-0227	13	YT-0348	6	YT-0419	107	YT-04388	74	YT-0497	106	YT-05607	109	YT-06311	354	YT-06871	383
YT-0120	11	YT-0228	13	YT-0349	6	YT-0420	107	YT-04390	75	YT-0498	106	YT-05608	109	YT-0632	341	YT-06872	384
YT-0122	11	YT-0232	13	YT-0350	6	YT-0421	350	YT-04391	75	YT-0499	106	YT-05609	109	YT-0633	343	YT-06873	387
YT-0123	11	YT-02330	13	YT-0351	6	YT-04211	350	YT-04392	75	YT-0500	112	YT-0561	113	YT-0635	341	YT-06875	386
YT-0125	11	YT-02331	13	YT-0352	6	YT-04301	74	YT-04393	75	YT-0501	112	YT-05610	109	YT-0636	341	YT-06876	391
YT-0127	11	YT-02332	13	YT-0353	6	YT-04302	74	YT-04394	75	YT-0502	112	YT-05611	109	YT-0637	341	YT-06877	391

YATO	page/strona	YATO	page/strona	YATO	page/strona	YATO	page/strona	YATO	page/strona	YATO	page/strona	YATO	page/strona	YATO	page/strona		
YT-06878	390	YT-0795	361	YT-08577	370; 473	YT-09571	280	YT-1040	81	YT-1134	83	YT-1223	35	YT-1292	34	YT-1407	25
YT-06879	391	YT-0796	361	YT-08590	370; 473	YT-0959	280	YT-1041	81	YT-1135	83	YT-1224	35	YT-1295	36	YT-1408	25
YT-06880	389	YT-0800	361	YT-0860	364	YT-0960	281	YT-1042	81	YT-1136	83	YT-1225	35	YT-1296	30	YT-1409	25
YT-06881	389	YT-0801	361	YT-0862	167; 401	YT-09611	281	YT-1043	81	YT-1138	83	YT-1226	35	YT-1297	26	YT-1410	25
YT-06882	388	YT-0802	361	YT-0863	167; 401	YT-0965	283	YT-1044	81	YT-1141	83	YT-1227	35	YT-1301	72	YT-1411	25
YT-06883	386	YT-0803	362	YT-0864	167; 401	YT-0967	284	YT-1045	81	YT-1142	83	YT-1228	35	YT-1302	72	YT-1412	25
YT-06884	387	YT-08035	362	YT-0865	167; 401	YT-0970	285	YT-1046	81	YT-1143	83	YT-1229	35	YT-1303	72	YT-1413	25
YT-06885	387	YT-0807	362	YT-0866	167; 401	YT-09702	285	YT-1047	81	YT-1146	83	YT-1230	35	YT-1304	72	YT-1414	25
YT-06888	385	YT-0808	362	YT-0867	167; 401	YT-09740	284	YT-1048	81	YT-1148	83	YT-1231	35	YT-1305	72	YT-1415	25
YT-0690	321	YT-0809	362	YT-0870	167; 401	YT-09741	284	YT-1049	81	YT-1150	83	YT-1232	35	YT-1306	72	YT-1416	25
YT-0691	321	YT-0810	362	YT-08707	285; 365	YT-09742	284	YT-1050	81	YT-1155	84	YT-1233	35	YT-1307	72	YT-1417	25
YT-06912	321	YT-0811	362	YT-0880	365	YT-09743	220; 284	YT-1052	81	YT-1157	86	YT-1234	35	YT-1308	72	YT-1418	25
YT-06913	321	YT-0813	354	YT-0882	313	YT-09744	220; 284	YT-1054	81	YT-1160	84	YT-1235	35	YT-1309	72	YT-1419	25
YT-06914	321	YT-0814	354	YT-0883	313	YT-09745	220; 284	YT-1055	81	YT-1161	84	YT-1236	35	YT-1310	72	YT-1420	25
YT-0692	373	YT-0817	353	YT-0884	313	YT-09746	220; 284	YT-1056	361	YT-1162	84	YT-1237	35	YT-1311	72	YT-1421	25
YT-0693	373	YT-0818	353	YT-0885	313	YT-09747	220; 284	YT-1060	82	YT-1163	84	YT-1238	35	YT-1312	72	YT-1422	25
YT-0694	373	YT-0819	353	YT-0886	313	YT-09748	220; 284	YT-1061	82	YT-1164	84	YT-1239	35	YT-1313	72	YT-1423	25
YT-0695	373	YT-08195	204; 345	YT-08920	303	YT-09749	220; 284	YT-1062	82	YT-11671	84	YT-1240	35	YT-1314	72	YT-1424	25
YT-0696	373	YT-0820	315	YT-08921	310	YT-09750	220; 284	YT-1064	82	YT-1168	84	YT-1241	37	YT-1315	72	YT-1425	26
YT-0697	373	YT-0821	315	YT-08922	310	YT-0980	283	YT-1065	86	YT-1169	85	YT-1242	37	YT-1316	72	YT-1426	26
YT-0699	373	YT-0822	315	YT-09000	302	YT-0981	283	YT-1066	86	YT-1175	85	YT-1243	37	YT-1317	72	YT-1427	26
YT-0700	318	YT-0823	315	YT-09002	301	YT-0982	283	YT-1067	82	YT-1176	85	YT-1244	37	YT-1318	72	YT-1429	25
YT-0701	318	YT-0824	315	YT-09003	301	YT-0990	285	YT-1068	86	YT-1177	85	YT-1246	36	YT-1319	72	YT-1430	25
YT-0704	319	YT-0825	315	YT-09008	303	YT-0993	285	YT-1069	86	YT-1178	85	YT-1247	36	YT-1320	72	YT-1431	25
YT-07041	319	YT-0826	315	YT-0902	302	YT-0994	285	YT-1070	83	YT-1179	85	YT-1248	36	YT-1322	72	YT-1432	25
YT-07042	318	YT-08295	364	YT-09061	303	YT-1000	80	YT-1071	83	YT-1180	85	YT-1249	36	YT-1323	72	YT-1433	25
YT-07043	318	YT-0830	364	YT-0907	311	YT-1001	80	YT-1072	83	YT-1183	85	YT-1250	36	YT-1324	72	YT-1434	25
YT-0705	318	YT-08305	364	YT-09071	311	YT-1002	80	YT-1073	83	YT-1184	85	YT-1251	36	YT-1326	72	YT-1435	25
YT-07055	290; 319	YT-0831	364	YT-09072	311	YT-1003	80	YT-1074	83	YT-1185	85	YT-1252	37	YT-1328	72	YT-1436	25
YT-07061	320	YT-0835	365	YT-0908	311	YT-1004	80	YT-1075	83	YT-1186	85	YT-1253	37; 353	YT-1330	72	YT-1437	26
YT-07063	320	YT-0836	334	YT-0910	311	YT-1005	80	YT-1076	83	YT-1187	85	YT-1254	37; 353	YT-1334	73	YT-1438	26
YT-0707	320	YT-0837	334	YT-09101	236; 312	YT-1006	80	YT-1077	83	YT-1188	85	YT-1255	36	YT-1335	73	YT-14411	53
YT-0708	320	YT-0838	331	YT-09102	236; 312	YT-1007	80	YT-1078	83	YT-1189	85	YT-1258	36	YT-1340	72	YT-14421	53
YT-0709	320	YT-08385	331	YT-09107	236; 312	YT-1008	80	YT-1079	83	YT-1191	85	YT-1259	36	YT-1341	72	YT-1443	53
YT-0710	320	YT-0840	352	YT-09108	236; 312	YT-1009	80	YT-1080	83	YT-1193	85	YT-12621	59	YT-1342	72	YT-14431	40
YT-07115	321	YT-0841	333	YT-0911	311	YT-1010	80	YT-1082	83	YT-1194	85	YT-12651	60	YT-1345	73	YT-1444	54
YT-0712	321	YT-0842	333	YT-0913	302	YT-1011	80	YT-1083	83	YT-1196	85	YT-12671	60	YT-1347	73	YT-1445	54
YT-0715	321	YT-0843	96	YT-0914	302	YT-1012	80	YT-1084	83	YT-1197	85	YT-1268	64	YT-1348	73	YT-14451	41
YT-0716	373	YT-0844	334	YT-09152	300	YT-1013	80	YT-1085	83	YT-1198	85	YT-12681	46	YT-1350	72	YT-1446	55
YT-0717	373	YT-0845	335	YT-09155	300	YT-1014	80	YT-1086	83	YT-1201	34	YT-12682	65	YT-1352	72	YT-14461	41
YT-0718	373	YT-0846	335	YT-0920	244; 291	YT-1015	80	YT-1088	83	YT-1202	34	YT-1269	64	YT-1355	72	YT-1447	55
YT-0720	28	YT-0847	334	YT-0921	244; 291	YT-1016	80	YT-1091	83	YT-1203	34	YT-12691	46	YT-1356	36	YT-14471	41
YT-0722	39	YT-08502	366; 469	YT-0923	245; 291	YT-1017	80	YT-1092	83	YT-1204	34	YT-1270	34	YT-1360	73	YT-1448	55
YT-0730	28	YT-08503	369; 472	YT-0930	245	YT-1018	80	YT-1093	83	YT-1205	34	YT-1271	34	YT-1370	332	YT-14481	42
YT-0731	33	YT-08505	367; 470	YT-0931	245	YT-1019	80	YT-1096	83	YT-1206	34	YT-1272	34	YT-1371	332	YT-1449	54
YT-0732	39	YT-08507	367; 470	YT-0932	245	YT-1020	80	YT-1100	83	YT-1207	34	YT-1273	34	YT-1372	332	YT-14491	40
YT-0733	28	YT-08508	366; 469	YT-0935	245	YT-1022	80	YT-1102	83	YT-1208	34	YT-1274	34	YT-1373	332	YT-1450	56
YT-0734	33	YT-08509	366; 469	YT-0936	245	YT-1025	80	YT-1105	83	YT-1209	34	YT-1275	34	YT-1374	332	YT-14501	42
YT-0735	39	YT-08513	368; 471	YT-0937	245	YT-1027	86	YT-1110	83	YT-1210	34	YT-1276	34	YT-1375	332	YT-1460	35
YT-0750	90	YT-08514	368; 471	YT-0938	245	YT-1028	86	YT-1115	83	YT-1211	34	YT-1277	34	YT-1378	332	YT-1461	35
YT-0751	90	YT-0852	368; 471	YT-0939	245	YT-1029	86	YT-1119	83	YT-1212	34	YT-1278	34	YT-1379	333	YT-1462	35
YT-0754	90	YT-08523	367; 470	YT-0940	245	YT-1030	81	YT-1121	83	YT-1213	34	YT-1279	34	YT-13790	333	YT-1463	35
YT-0755	90	YT-08530	369; 472	YT-0941	245	YT-1031	81	YT-1122	83	YT-1214	34	YT-1280	34	YT-1381	333	YT-1464	35
YT-0760	90	YT-08531	368; 471	YT-0942	245	YT-1032	81	YT-1123	83	YT-1215	34	YT-1281	34	YT-1382	333	YT-1465	35
YT-0761	90	YT-08532	369; 472	YT-09501	278	YT-1033	81	YT-1124	83	YT-1216	34	YT-1282	34	YT-1385	333	YT-1466	35
YT-0770	90	YT-08561	367; 470	YT-09505	279	YT-1034	81	YT-1127	83	YT-1217	34	YT-1283	34	YT-1400	26	YT-1467	35
YT-0771	90	YT-08563	366; 469	YT-09511	278	YT-1035	81	YT-1128	83	YT-1218	34	YT-1284	34	YT-1401	25	YT-1468	35
YT-07711	90	YT-08570	370; 473	YT-0952	278	YT-1036	81	YT-1129	83	YT-1219	34	YT-1285	34	YT-1403	25	YT-1469	35
YT-0781	91	YT-08571	370; 473	YT-0953	279	YT-1037	81	YT-1130	83	YT-1220	34	YT-1286	34	YT-1404	25	YT-1470	35
YT-0782	91	YT-08572	370; 473	YT-09540	279	YT-1038	81	YT-1132	83	YT-1221	35	YT-1289	34	YT-1405	25	YT-1471	35
YT-07822	91	YT-08575	370; 473	YT-09564	280	YT-1039	81	YT-1133	83	YT-1222	35	YT-1291	34	YT-1406	25	YT-1472	35

YATO	page/strona	YATO	page/strona	YATO	page/strona	YATO	page/strona	YATO	page/strona	YATO	page/strona	YATO	page/strona	YATO	page/strona		
YT-2293	142	YT-24207	288	YT-2547	359	YT-25940	94	YT-2643	98	YT-2866	371	YT-2958	181	YT-3074	260	YT-3262	177
YT-22930	141	YT-24208	288	YT-25480	335	YT-25941	94	YT-2644	98	YT-28920	178; 400	YT-2959	181	YT-3076	260	YT-3263	177
YT-2294	142	YT-24209	288	YT-25802	99	YT-25942	94	YT-2645	98	YT-28950	178	YT-2960	182	YT-3077	260	YT-3264	177
YT-2295	142	YT-24220	288	YT-25803	99	YT-25943	94	YT-2647	98	YT-28951	178	YT-2961	182	YT-3078	260	YT-3265	177
YT-2296	139	YT-24221	288	YT-25804	99	YT-25950	94	YT-2648	98	YT-28952	178	YT-2962	182	YT-3079	260	YT-3266	177
YT-2297	139	YT-24224	288	YT-25805	99	YT-25951	94	YT-2649	98	YT-28953	178	YT-2963	182	YT-3081	260	YT-3267	177
YT-2298	139	YT-24225	288	YT-25806	99	YT-25952	94	YT-2650	98	YT-28954	178	YT-2964	182	YT-3082	260	YT-3268	177
YT-2299	139	YT-24301	372	YT-25807	99	YT-25953	94	YT-2653	98	YT-28955	178	YT-2965	182	YT-3083	260	YT-3269	177
YT-2300	138	YT-2449	125	YT-25808	99	YT-25954	94	YT-2655	98	YT-28956	178	YT-2966	182	YT-3084	260	YT-3270	177
YT-2302	139	YT-2450	125	YT-25809	99	YT-25955	94	YT-2657	98	YT-28957	178	YT-2967	182	YT-3101	195	YT-3271	177
YT-2305	140	YT-2451	125	YT-25810	99	YT-25956	94	YT-2658	98	YT-28958	178	YT-2968	182	YT-3102	195	YT-3272	177
YT-2307	139	YT-2452	125	YT-25811	99	YT-25957	94	YT-2661	98	YT-28959	178	YT-2969	182	YT-3103	195	YT-3273	177
YT-2313	142	YT-2453	125	YT-25831	99	YT-25958	94	YT-2663	98	YT-28960	178	YT-2970	182	YT-3106	195	YT-3274	177
YT-2316	143	YT-2459	125	YT-25832	99	YT-25959	94	YT-2665	98	YT-28961	178	YT-2971	182	YT-3107	195	YT-3275	177
YT-2319	142	YT-2460	125	YT-25833	99	YT-25960	94	YT-2667	98	YT-28962	178	YT-2972	182	YT-3108	195	YT-3276	177
YT-2340	286	YT-2461	126; 399	YT-25834	99	YT-25961	94	YT-2668	99	YT-28963	178	YT-2973	182	YT-3130	195	YT-3277	177
YT-2341	286	YT-2463	126; 399	YT-25835	99	YT-25965	95	YT-2670	99	YT-28964	178	YT-2974	182	YT-3133	195	YT-3278	177
YT-2346	286	YT-2466	126; 399	YT-25836	99	YT-25966	96	YT-2741	98	YT-28965	178	YT-2975	181	YT-3134	195	YT-3279	177
YT-2357	286	YT-2468	126; 399	YT-25837	99	YT-25967	96	YT-2742	98	YT-28966	178	YT-2976	182	YT-3150	195	YT-3280	177
YT-2370	286	YT-2469	126; 399	YT-25838	99	YT-25968	97	YT-2743	98	YT-28967	178	YT-2977	182	YT-3160	196	YT-3281	177
YT-23701	286	YT-2473	125	YT-25839	99	YT-25971	96	YT-2744	98	YT-2900	226	YT-2978	181	YT-3161	196	YT-3282	177
YT-2371	286	YT-2476	125	YT-25840	99	YT-25972	102	YT-2745	98	YT-29001	226	YT-2979	181	YT-3163	196	YT-3283	177
YT-2372	286	YT-2482	128; 227	YT-25852	99	YT-25980	95	YT-2746	98	YT-2910	226	YT-2980	182	YT-3200	195; 492	YT-3284	177
YT-2373	287	YT-2483	128; 227	YT-25853	99	YT-25981	96	YT-2748	98	YT-2911	226	YT-2981	182	YT-3201	195; 492	YT-3285	177
YT-2374	287	YT-2484	128; 227	YT-25854	99	YT-25982	97	YT-2750	98	YT-2912	226	YT-2982	182	YT-3202	195; 492	YT-3286	177
YT-2375	287	YT-2485	128; 227	YT-25855	99	YT-25985	95	YT-2752	98	YT-2913	226	YT-2983	182	YT-3203	195; 492	YT-3287	177
YT-2376	287	YT-2488	128; 227	YT-25856	99	YT-25986	95	YT-2753	98	YT-2914	226	YT-2984	182	YT-3204	195; 492	YT-3288	177
YT-2380	288	YT-2489	128; 227	YT-25857	99	YT-25987	95	YT-2754	98	YT-2916	226	YT-2985	182	YT-3221	196; 492	YT-3289	177
YT-2381	288	YT-2490	128; 227	YT-25861	99	YT-25988	95	YT-2756	98	YT-2917	226	YT-2986	182	YT-3222	196; 492	YT-3290	177
YT-2382	288	YT-2491	128; 227	YT-25862	99	YT-25989	95	YT-2797	102	YT-2918	226	YT-2987	182	YT-3223	196; 492	YT-3291	177
YT-2383	288	YT-2492	128; 227	YT-25863	99	YT-25990	95	YT-2798	102	YT-2919	226	YT-2988	182	YT-3224	196; 492	YT-3292	177
YT-2384	288	YT-2493	128; 227	YT-25900	94	YT-25991	95	YT-2800	103	YT-2920	226	YT-2989	182	YT-3230	196; 492	YT-3293	177
YT-2385	288	YT-2494	128; 227	YT-25901	94	YT-25992	95	YT-2801	103	YT-2921	226	YT-2990	182	YT-3231	196; 492	YT-3294	177
YT-2390	289	YT-2510	323	YT-25902	94	YT-25993	95	YT-2802	103	YT-2926	181	YT-2991	182	YT-3232	196; 492	YT-3295	177
YT-2391	289	YT-25105	323	YT-25903	94	YT-25994	95	YT-2806	102	YT-2927	181	YT-2992	182	YT-3233	196; 492	YT-3296	177
YT-2392	289	YT-2511	322	YT-25904	94	YT-25995	95	YT-2810	103	YT-2930	181	YT-2993	182	YT-3234	196; 492	YT-3297	177
YT-2393	289	YT-2512	322	YT-25905	94	YT-25996	95	YT-2811	103	YT-2931	181	YT-2994	182	YT-3236	176	YT-3298	177
YT-2394	289	YT-2513	322	YT-25906	94	YT-25997	95	YT-2812	103	YT-2932	181	YT-2995	182	YT-3237	176	YT-3299	177
YT-2395	289	YT-2514	322	YT-25907	94	YT-25998	95	YT-2815	100; 132	YT-2933	181	YT-2996	182	YT-3238	176	YT-3300	177
YT-2396	289	YT-25145	322; 335	YT-25908	94	YT-2601	98	YT-2816	100; 132	YT-2934	181	YT-2997	182	YT-3239	176	YT-3303	180
YT-2397	289	YT-2515	322	YT-25909	94	YT-2602	98	YT-2817	100; 132	YT-2935	181	YT-3001	274	YT-3240	176	YT-3304	180
YT-2398	289	YT-2516	322	YT-25910	94	YT-2604	98	YT-2818	100; 132	YT-2937	181	YT-3002	274	YT-3241	176	YT-3306	180
YT-2399	289	YT-2517	322	YT-25911	94	YT-2606	98	YT-2819	100; 132	YT-2939	181	YT-3003	274	YT-3242	176	YT-3308	180
YT-2401	289	YT-2518	322	YT-25912	94	YT-2608	98	YT-2820	100; 132	YT-2940	181	YT-3004	274	YT-3243	176	YT-3311	180
YT-2402	289	YT-2519	322	YT-25913	94	YT-2609	98	YT-2821	100; 132	YT-2941	181	YT-3005	274	YT-3244	176	YT-3313	180
YT-2403	289	YT-2520	322	YT-25914	94	YT-2610	98	YT-2822	100; 132	YT-2942	181	YT-30061	274	YT-3245	176	YT-3315	180
YT-2404	289	YT-2521	322	YT-25920	94	YT-2612	98	YT-2823	100; 132	YT-2943	181	YT-30062	274	YT-3246	176	YT-3317	180
YT-2405	289	YT-2522	322	YT-25921	94	YT-2613	98	YT-2824	100; 132	YT-2944	181	YT-30063	274	YT-3247	176	YT-3318	180
YT-2406	289	YT-2523	322	YT-25922	94	YT-2614	98	YT-2825	100; 132	YT-2945	181	YT-30064	274	YT-3248	176	YT-3321	180
YT-2407	289	YT-25331	335	YT-25923	94	YT-2615	98	YT-2826	100; 132	YT-2946	181	YT-30071	274	YT-3249	176	YT-3322	180
YT-24091	289	YT-2535	359	YT-25924	94	YT-2618	98	YT-2827	100; 132	YT-2947	181	YT-30072	274	YT-3250	176	YT-3323	180
YT-24092	289	YT-2536	359	YT-25925	94	YT-2633	98	YT-2828	100; 132	YT-2948	181	YT-30073	274	YT-3251	176	YT-3324	180
YT-24093	289	YT-2537	359	YT-25926	94	YT-2634	98	YT-28290	101; 133	YT-2949	181	YT-30074	274	YT-3252	176	YT-3327	180
YT-24094	289	YT-2539	325	YT-25927	94	YT-2635	98	YT-28293	101; 133	YT-2950	181	YT-3022	274	YT-3253	176	YT-3329	180
YT-24095	289	YT-25391	325	YT-25928	94	YT-2636	98	YT-28300	146	YT-2951	181	YT-3023	274	YT-3254	176	YT-3330	180
YT-24201	288	YT-2540	324	YT-25929	94	YT-2637	98	YT-2861	146; 268	YT-2952	181	YT-3024	274	YT-3255	176	YT-3332	180
YT-24202	288	YT-2541	325	YT-25930	94	YT-2638	98	YT-2862	146; 268	YT-2953	181	YT-3025	274	YT-3256	176	YT-3333	180
YT-24203	288	YT-2542	326	YT-25931	94	YT-2639	98	YT-2863	146; 268	YT-2954	181	YT-3026	274	YT-3257	176	YT-3334	180
YT-24204	288	YT-2543	326	YT-25932	94	YT-2640	98	YT-28631	146	YT-2955	181	YT-3071	260	YT-3258	176	YT-3336	180
YT-24205	288	YT-2544	359	YT-25933	94	YT-2641	98	YT-2864	146	YT-2956	181	YT-3072	260	YT-3259	176	YT-3338	180
YT-24206	288	YT-2546	359	YT-25934	94	YT-2642	98	YT-2865	371	YT-2957	181	YT-3073	260	YT-3261	177	YT-3343	180

YATO	page/strona	YATO	page/strona	YATO	page/strona	YATO	page/strona	YATO	page/strona	YATO	page/strona	YATO	page/strona	YATO	page/strona	YATO	page/strona
YT-3345	180	YT-3591	210	YT-3813	29	YT-38831	48	YT-4170	174	YT-4357	177	YT-44639	173	YT-4563	155	YT-47149	159
YT-3346	180	YT-3600	240	YT-3814	29	YT-38884	69	YT-4171	174	YT-4358	177	YT-44640	173	YT-4564	155	YT-47150	159
YT-3349	180	YT-36007	240	YT-3820	29	YT-38884	52	YT-4172	174	YT-4359	177	YT-44642	173	YT-4570	155	YT-47151	159
YT-3350	180	YT-36011	240	YT-3821	29	YT-38886	59	YT-4173	174	YT-4361	175	YT-44643	173	YT-4571	155	YT-47152	159
YT-3351	180	YT-36012	240	YT-3822	29	YT-38886	43	YT-4174	174	YT-4362	175	YT-44645	173	YT-4573	155	YT-4720	179
YT-3353	180	YT-3609	240	YT-3823	29	YT-38887	67	YT-4175	174	YT-4363	175	YT-44650	173	YT-4590	157; 397	YT-4721	179
YT-3370	180	YT-36092	240	YT-3824	29	YT-38887	50	YT-4176	174	YT-4364	175	YT-44652	173	YT-4594	156	YT-4722	179
YT-3371	180	YT-36095	241	YT-3825	29	YT-38875	49	YT-4177	174	YT-4367	175	YT-44653	173	YT-4600	156	YT-4723	179
YT-3372	180	YT-3610	241	YT-3826	29	YT-38881	50	YT-4178	174	YT-4369	175	YT-44654	173	YT-4601	156	YT-4730	161
YT-3373	180	YT-36119	241	YT-3827	29	YT-38891	47	YT-4179	174	YT-4370	175	YT-44655	173	YT-4602	156	YT-4750	205
YT-3374	180	YT-3612	241	YT-3828	29	YT-3890	66	YT-4180	174	YT-4373	175	YT-44656	173	YT-4603	156	YT-4751	205
YT-3376	180	YT-36128	242	YT-3829	29	YT-38901	48	YT-4181	174	YT-4375	175	YT-44657	173	YT-4604	156	YT-4752	205
YT-3377	180	YT-36129	242	YT-3830	29	YT-3891	63	YT-4182	174	YT-4376	175	YT-44658	173	YT-4605	156	YT-4755	205
YT-3380	180	YT-36171	242; 290	YT-3831	29	YT-38911	45	YT-4183	174	YT-4379	175	YT-44659	173	YT-4620	156; 397	YT-4757	205
YT-3381	180	YT-3618	242; 290	YT-3832	29	YT-3893	68	YT-4184	174	YT-4380	175	YT-44660	173	YT-4622	156; 397	YT-4758	205
YT-3400	197	YT-36420	386	YT-3833	29	YT-38931	51	YT-4185	174	YT-4383	175	YT-44661	173	YT-4623	156; 397	YT-4759	205
YT-3401	197	YT-36451	242	YT-3839	31	YT-3894	69	YT-4186	174	YT-4385	175	YT-44662	173	YT-4624	156; 397	YT-4761	205
YT-3402	197	YT-36452	242	YT-3840	30	YT-38941	52	YT-4187	174	YT-4390	175	YT-44663	173	YT-4625	156; 397	YT-4763	205
YT-3403	197	YT-36453	242	YT-3841	31	YT-3895	314	YT-4188	174	YT-4400	179	YT-44664	173	YT-4626	156; 397	YT-4764	205
YT-3404	197	YT-36454	242	YT-3842	29	YT-38951	314	YT-4189	174	YT-4401	179	YT-44666	173	YT-4630	156; 397	YT-4766	205
YT-3405	197	YT-36700	233; 248; 423	YT-3843	29	YT-39009	70; 150	YT-4190	174	YT-4402	179	YT-44667	173	YT-4631	156; 397	YT-4767	205
YT-3407	197	YT-36704	233; 248; 424	YT-3844	29	YT-39280	70	YT-4191	174	YT-4403	179	YT-44668	173	YT-4632	156; 397	YT-4768	205
YT-3408	197	YT-36706	233; 248; 423	YT-3845	29	YT-4020	172	YT-4192	174	YT-4430	171	YT-44673	173	YT-4633	156; 397	YT-4769	205
YT-3409	197	YT-36709	233; 248; 424	YT-3847	30	YT-4025	172	YT-4200	174	YT-4431	171	YT-44674	173	YT-4634	156; 397	YT-4870	8
YT-3410	197	YT-3701	252	YT-3848	30	YT-4030	172	YT-4201	174	YT-4432	171	YT-44675	173	YT-46800	161	YT-4871	8
YT-3411	197	YT-3702	252	YT-3849	30	YT-4032	172	YT-4202	174	YT-4433	171	YT-44676	173	YT-46801	161	YT-4872	8
YT-3412	197	YT-3703	253	YT-3850	30	YT-4035	172	YT-4203	174	YT-4434	171	YT-44700	173	YT-46802	161	YT-4873	8
YT-3413	197	YT-3704	253	YT-3851	31; 353	YT-4040	172	YT-4204	174	YT-4435	171	YT-4491	154	YT-46803	161	YT-4874	8
YT-3414	197	YT-3705	253	YT-3853	30	YT-4042	172	YT-4205	174	YT-4436	171	YT-4492	154	YT-46804	161	YT-4875	8
YT-3415	197	YT-3706	253	YT-3854	30	YT-4045	172	YT-4206	174	YT-4437	171	YT-4493	154	YT-46810	161	YT-4876	8
YT-3416	197	YT-3707	253	YT-3855	57	YT-4048	172	YT-4207	174	YT-4438	171	YT-4494	154	YT-46811	161	YT-4877	8
YT-3417	197	YT-3708	253	YT-3856	57	YT-4050	172	YT-4208	174	YT-4439	171	YT-4495	154	YT-46812	161	YT-4878	8
YT-3421	197	YT-3712	253	YT-38561	43	YT-4052	172	YT-4209	174	YT-4440	171	YT-4496	154	YT-46813	161	YT-4879	8
YT-3430	198	YT-3713	253	YT-3857	58	YT-4055	172	YT-4210	174	YT-4441	171	YT-4497	154	YT-46814	161	YT-4880	8
YT-3431	198	YT-3714	253	YT-38631	57	YT-4060	172	YT-4211	174	YT-4442	171	YT-4498	154	YT-46820	161	YT-4881	8
YT-3432	198	YT-37141	253	YT-38641	57	YT-4065	172	YT-4212	174	YT-4443	171	YT-4499	154	YT-46821	161	YT-4882	8
YT-3433	198	YT-37160	254	YT-3865	71	YT-4070	172	YT-4213	174	YT-4444	171	YT-4500	154	YT-46822	161	YT-4883	8
YT-3434	198	YT-37161	254	YT-38671	44	YT-4075	172	YT-4214	174	YT-4445	171	YT-4501	154	YT-46823	161	YT-4884	8
YT-3435	198	YT-37164	254	YT-3868	59	YT-4080	172	YT-4215	174	YT-4446	171	YT-4502	154	YT-4690	160	YT-4885	8
YT-3440	198	YT-37170	254	YT-38681	44	YT-4085	172	YT-4216	174	YT-4447	171	YT-4503	154	YT-4691	160	YT-4901	8
YT-3441	198	YT-3725	178; 255	YT-38682	59	YT-4090	172	YT-4217	174	YT-4448	171	YT-4504	154	YT-4692	160	YT-4902	8
YT-3442	198	YT-3726	178; 255	YT-3869	60	YT-4100	172	YT-4218	174	YT-4449	171	YT-4505	154	YT-4693	160	YT-4903	8
YT-3443	198	YT-3727	178	YT-3870	60	YT-4110	172	YT-4219	174	YT-4450	171	YT-4506	154	YT-4694	160	YT-4904	8
YT-3444	198	YT-3728	178	YT-3871	61	YT-4120	172	YT-4220	174	YT-4451	171	YT-4507	154	YT-4695	160	YT-4905	8
YT-3445	198	YT-3730	252	YT-3872	61	YT-4140	172	YT-4221	174	YT-4452	171	YT-4508	154	YT-4700	158	YT-4906	8
YT-3460	196	YT-3735	210; 255	YT-3873	61	YT-4160	172	YT-4222	174	YT-4453	171	YT-4509	154	YT-4701	158	YT-4907	8
YT-3461	196	YT-3736	210; 255	YT-3874	61	YT-41602	172	YT-4223	174	YT-4454	171	YT-4510	154	YT-4705	158	YT-4908	8
YT-3462	196	YT-3740	210	YT-38741	44	YT-41603	172	YT-4224	174	YT-4455	171	YT-4515	157; 397	YT-4710	158	YT-4909	8
YT-34680	199	YT-37690	80	YT-3877	62	YT-41604	172	YT-4225	174	YT-4456	171	YT-4516	157; 397	YT-4711	159	YT-4910	8
YT-34681	199	YT-3801	29	YT-3878	63	YT-41605	172	YT-4226	174	YT-4457	171	YT-4518	157; 397	YT-4712	159	YT-4911	8
YT-34682	199	YT-3802	29	YT-38781	45	YT-4161	174	YT-4227	174	YT-4458	171	YT-4519	157; 397	YT-47121	159	YT-4912	8
YT-34683	199	YT-3803	29	YT-38782	62	YT-4162	174	YT-4228	174	YT-4460	171	YT-4520	157; 397	YT-4713	160	YT-4915	19
YT-34684	200	YT-3804	29	YT-3879	65	YT-4163	174	YT-4229	174	YT-4461	171	YT-4521	157; 397	YT-4714	160	YT-4916	19
YT-34685	200	YT-3805	29	YT-38791	47	YT-4164	174	YT-4230	174	YT-4462	171	YT-4522	157; 397	YT-47141	159	YT-4917	19
YT-34686	200	YT-3806	29	YT-3880	67	YT-41641	175	YT-4350	177	YT-44630	173	YT-4550	154	YT-47142	159	YT-4918	19
YT-34687	200	YT-3807	29	YT-38801	49	YT-41642	175	YT-4351	177	YT-44631	173	YT-4551	154	YT-47143	159	YT-4919	19
YT-34688	201	YT-3808	29	YT-3881	68	YT-4165	174	YT-4352	177	YT-44632	173	YT-4552	154	YT-47144	159	YT-4920	19
YT-34689	201	YT-3809	29	YT-38811	51	YT-4166	174	YT-4353	177	YT-44633	173	YT-4553	154	YT-47145	159	YT-4921	19
YT-34690	201	YT-3810	29	YT-3882	59	YT-4167	174	YT-4354	177	YT-44634	173	YT-4560	155	YT-47146	159	YT-4922	19
YT-34691	201	YT-3811	29	YT-38821	43	YT-4168	174	YT-4355	177	YT-44635	173	YT-4561	155	YT-47147	159	YT-4923	19
YT-3590	210	YT-3812	29	YT-3883	66	YT-4169	174	YT-4356	177	YT-44637	173	YT-4562	155	YT-47148	159	YT-4924	19

YATO	page/strona	YATO	page/strona	YATO	page/strona	YATO	page/strona	YATO	page/strona	YATO	page/strona	YATO	page/strona	YATO	page/strona		
YT-4925	19	YT-5497	264	YT-55478	309	YT-6005	185	YT-60907	187	YT-6182	214	YT-62361	214	YT-63958	164	YT-6581	118
YT-4926	19	YT-5499	264	YT-55479	310	YT-6012	185	YT-6091	187	YT-6183	214	YT-6237	214	YT-6401	164	YT-6582	118
YT-4927	19	YT-5500	264	YT-55480	237; 305	YT-6013	185	YT-6093	187	YT-6184	214	YT-6238	214	YT-6402	164	YT-6583	118
YT-4928	19	YT-5501	264	YT-55481	237; 305	YT-6014	185	YT-6095	187	YT-6185	214	YT-6239	214	YT-6403	164	YT-6600	118
YT-4937	19	YT-5502	264	YT-55482	237; 305	YT-6015	185	YT-6097	187	YT-6186	214	YT-6241	158	YT-6404	164	YT-6601	118
YT-4945	19	YT-5503	264	YT-5555	287	YT-6016	185	YT-6099	187	YT-6187	214	YT-6242	158	YT-6405	164	YT-6602	118
YT-4961	18	YT-5504	264	YT-55560	380	YT-6017	185	YT-6101	188	YT-6188	214	YT-6243	158	YT-6406	164	YT-6610	118
YT-4962	18	YT-5505	264	YT-55561	380	YT-6022	185	YT-6102	188	YT-6189	214	YT-6244	158	YT-6407	164	YT-6611	118
YT-4963	18	YT-5506	264	YT-55562	380	YT-6023	185	YT-6103	188	YT-6190	214	YT-6245	158	YT-6408	164	YT-6612	118
YT-4964	18	YT-5507	264	YT-55565	381	YT-6024	185	YT-6104	188	YT-6191	214	YT-6246	158	YT-6409	164	YT-6740	246
YT-4965	18	YT-5508	264	YT-55568	381	YT-6025	185	YT-6105	188	YT-6192	214	YT-6247	158	YT-6410	164	YT-6741	246
YT-4966	18	YT-55290	299	YT-55580	381	YT-6030	186	YT-6106	188	YT-6193	214	YT-6248	158	YT-6412	164	YT-6742	246
YT-5038	12	YT-55291	295	YT-55581	381	YT-6032	186	YT-6107	188	YT-6194	214	YT-6249	158	YT-6413	164	YT-6743	246
YT-5130	127; 400	YT-55292	298	YT-55582	381	YT-6045	186	YT-6108	188	YT-6219	217	YT-6251	158	YT-6414	164	YT-6745	246
YT-5131	127; 400	YT-55293	296	YT-5702	213	YT-6046	186	YT-6110	188	YT-6220	217	YT-6253	158	YT-6415	164	YT-6750	247
YT-5140	127; 400	YT-5530	297	YT-5703	213	YT-60480	187	YT-6111	188	YT-6221	217	YT-6256	158	YT-6416	164	YT-6751	247
YT-5141	127; 400	YT-5531	304	YT-5704	213	YT-60482	187	YT-6112	188	YT-6222	217	YT-6258	158	YT-6417	164	YT-6752	247
YT-5142	127; 400	YT-55311	310	YT-5710	210	YT-60484	187	YT-6113	188	YT-62228	214	YT-6260	158	YT-6420	165	YT-6753	247
YT-5200	256	YT-5532	304	YT-5835	111	YT-60488	187	YT-61132	188	YT-62229	214	YT-6280	158	YT-6421	165	YT-6754	247
YT-5202	256	YT-55321	310	YT-5837	111	YT-60489	187	YT-6114	188	YT-6223	214	YT-6281	158	YT-6422	165	YT-6755	247
YT-5203	256	YT-5533	304	YT-5838	111	YT-6050	187	YT-6116	188	YT-62231	214	YT-6330	202	YT-6423	165	YT-6756	247
YT-5204	256	YT-55331	310	YT-58950	379	YT-6052	187	YT-6117	188	YT-62238	214	YT-6331	202	YT-6424	165	YT-6757	247
YT-5207	256	YT-5534	304	YT-58951	379	YT-60522	187	YT-6120	188	YT-62239	214	YT-6332	202	YT-64250	165	YT-6801	184
YT-5209	256	YT-55341	310	YT-58953	379	YT-6053	187	YT-6121	189	YT-6224	214	YT-6333	202	YT-64251	165	YT-6803	184
YT-5210	256	YT-5535	306	YT-58954	379	YT-60532	187	YT-6123	189	YT-62241	214	YT-6334	202	YT-64252	165	YT-6854	371
YT-5212	256	YT-55351	310	YT-58955	379	YT-60533	187	YT-6124	189	YT-62243	214	YT-6335	202	YT-64253	165	YT-6855	371
YT-5214	256	YT-5536	306	YT-58957	379	YT-6055	187	YT-6125	189	YT-62244	214	YT-6336	202	YT-64254	165	YT-6862	371
YT-5218	256	YT-55361	310	YT-5901	261; 379; 438	YT-6056	187	YT-6126	189	YT-62245	214	YT-6337	202	YT-64255	165	YT-6863	371
YT-5226	257	YT-5537	307	YT-5902	261; 379; 438	YT-6057	187	YT-6128	189	YT-62246	214	YT-6338	202	YT-64256	165	YT-6903	129; 148; 365
YT-5228	257	YT-55371	310	YT-5904	261; 379; 438	YT-6058	187	YT-6129	189	YT-62248	214	YT-6339	202	YT-64257	165	YT-6907	129; 148; 365
YT-5230	257	YT-5538	307	YT-5905	261; 379; 438	YT-60582	187	YT-6131	189	YT-62249	214	YT-6340	203	YT-64258	165	YT-6916	129; 148; 365
YT-5234	257	YT-55381	310	YT-5911	379	YT-60583	187	YT-6132	189	YT-6225	214	YT-6341	203	YT-64270	164	YT-6925	265
YT-5237	257	YT-5539	308	YT-5913	379	YT-6060	187	YT-6133	189	YT-62251	214	YT-6342	203	YT-64271	164	YT-6926	265
YT-5240	257	YT-55391	310	YT-5914	379	YT-6061	187	YT-6136	188	YT-62258	214	YT-6343	203	YT-64272	164	YT-6927	265
YT-5242	257	YT-5540	308	YT-5920	188	YT-6062	187	YT-6137	188	YT-62259	214	YT-6344	203	YT-6440	164	YT-69280	265
YT-5243	257	YT-55401	310	YT-5921	188	YT-6063	187	YT-6138	189	YT-6226	214	YT-6345	203	YT-6441	164	YT-69281	265
YT-5245	257	YT-5541	307	YT-5923	188	YT-60632	187	YT-6140	216	YT-62261	214	YT-6346	203	YT-6442	164	YT-69285	265
YT-5247	257	YT-55411	310	YT-5924	188	YT-60633	187	YT-6141	216	YT-62268	214	YT-6348	203	YT-6443	164	YT-69286	265
YT-5250	255	YT-5542	307	YT-5925	188	YT-60634	187	YT-6142	216	YT-62269	214	YT-6349	203	YT-6444	164	YT-69287	265
YT-5251	255	YT-55421	310	YT-5926	188	YT-6065	187	YT-6143	216	YT-6227	214	YT-6350	203	YT-6445	164	YT-69900	442
YT-5252	255	YT-5543	304	YT-5927	188	YT-60652	187	YT-6144	216	YT-62271	214	YT-6351	203	YT-6446	164	YT-69901	442
YT-5253	255	YT-55443	304	YT-5930	189	YT-6066	187	YT-6145	216	YT-6228	214	YT-6353	202	YT-6447	164	YT-69902	442
YT-5254	255	YT-55444	306	YT-5932	189	YT-60665	187	YT-6146	217	YT-6229	214	YT-6354	202	YT-6448	164	YT-69903	442
YT-5255	255	YT-55451	308	YT-5933	189	YT-60668	187	YT-6147	216	YT-6230	214	YT-6355	202	YT-6449	164	YT-69905	442
YT-5260	255	YT-55453	308	YT-5935	189	YT-6067	187	YT-6148	216	YT-6231	214	YT-6356	202	YT-6450	164	YT-69906	442
YT-5261	255	YT-55455	306	YT-5946	189	YT-6068	187	YT-6149	216	YT-6232	214	YT-6358	202	YT-6451	164	YT-69907	442
YT-5262	255	YT-55456	304	YT-5947	189	YT-60682	187	YT-6150	216	YT-62328	214	YT-6359	205	YT-6452	164	YT-69908	442
YT-5400	259	YT-55457	308	YT-5953	185	YT-6070	187	YT-6151	217	YT-62329	214	YT-6360	205	YT-6453	164	YT-69910	442
YT-5402	259	YT-55458	307	YT-5954	185	YT-6071	187	YT-6152	216	YT-6233	214	YT-63701	204; 235	YT-6454	164	YT-69911	442
YT-5404	259	YT-55462	307	YT-5955	185	YT-6072	187	YT-6153	216	YT-62331	214	YT-63702	204; 235	YT-6501	166	YT-69912	442
YT-5405	259	YT-55463	305	YT-5956	185	YT-6075	187	YT-6154	216	YT-62338	214	YT-63703	204; 235	YT-6502	166	YT-69913	442
YT-5410	259	YT-55464	306	YT-5965	185	YT-6076	187	YT-6155	216	YT-62339	214	YT-63704	204; 235	YT-6503	166	YT-69914	442
YT-5415	259; 405	YT-55465	309	YT-5966	185	YT-6077	187	YT-6156	216	YT-6234	214	YT-63705	204; 235	YT-6504	166	YT-69920	442
YT-5416	259; 405	YT-55466	309	YT-5973	186	YT-6078	187	YT-6160	215	YT-62341	214	YT-63740	204; 235	YT-65048	166	YT-69921	442
YT-5417	259; 405	YT-55469	306	YT-5974	186	YT-6080	187	YT-6161	215	YT-62348	214	YT-63951	164	YT-65049	166	YT-69922	442
YT-5490	264	YT-55471	309	YT-5975	186	YT-6081	187	YT-6162	215	YT-62349	214	YT-63952	164	YT-6505	166	YT-69923	442
YT-5491	264	YT-55472	305	YT-5992	186	YT-6082	187	YT-6163	215	YT-6235	214	YT-63953	164	YT-6506	166	YT-69924	442
YT-5492	264	YT-55473	305	YT-5994	186	YT-6083	187	YT-6164	215	YT-62351	214	YT-63954	164	YT-6510	166; 234	YT-7000	243
YT-5493	264	YT-55474	308	YT-6002	185	YT-6085	187	YT-6165	215	YT-62358	214	YT-63955	164	YT-6511	166; 234	YT-7001	243
YT-5494	264	YT-55476	309	YT-6003	185	YT-6086	187	YT-6180	214	YT-62359	214	YT-63956	164	YT-6512	166; 234	YT-7003	243
YT-5496	264	YT-55477	309	YT-6004	185	YT-60905	187	YT-6181	214	YT-6236	214	YT-63957	164	YT-6513	166; 234	YT-7004	243

YATO	page/strona	YATO	page/strona	YATO	page/strona	YATO	page/strona	YATO	page/strona	YATO	page/strona	YATO	page/strona		
YT-82271	418	YT-83184	220	YT-83364	221	YT-83458	222	YT-8415	219	YT-84962	437; 504	YT-8843	488	YT-99811	478
YT-82272	419	YT-83185	220	YT-83365	221	YT-83480	222	YT-8416	219	YT-84963	437; 504	YT-8845	488	YT-99812	478
YT-82280	419	YT-83186	220	YT-83366	221	YT-83481	222	YT-8417	219	YT-84970	438; 504	YT-8849	488	YT-99813	478
YT-82288	422	YT-83187	220	YT-83371	221	YT-83482	222	YT-8418	219	YT-84971	438; 504	YT-8851	491	YT-99814	479
YT-82291	422	YT-83188	220	YT-83372	221	YT-83483	222	YT-8440	218	YT-85000	433; 499	YT-8852	491	YT-99815	479
YT-82292	423	YT-83189	220	YT-83373	221	YT-83484	222	YT-8441	218	YT-85002	433; 499	YT-8853	491	YT-99830	480
YT-82293	423	YT-83190	220	YT-83374	221	YT-83485	222	YT-8442	218	YT-85021	433; 499	YT-8854	491	YT-99841	482
YT-82401	147; 249; 425	YT-83200	220	YT-83375	221	YT-83486	222	YT-8443	218	YT-85080	429; 495	YT-8865	493	YT-99845	485
YT-8245	148; 249; 424	YT-83201	220	YT-83376	221	YT-83487	222	YT-8444	218	YT-85090	429; 495	YT-8866	493	YT-99848	479
YT-82455	147; 249; 425	YT-83202	220	YT-83381	221	YT-83488	222	YT-8445	218	YT-85100	430; 496	YT-8867	493	YT-99850	486
YT-8271	148; 249; 424	YT-83203	220	YT-83382	221	YT-83490	222	YT-8446	218	YT-85110	430; 496	YT-8868	493	YT-99852	486
YT-8272	148; 249; 424	YT-83204	220	YT-83383	221	YT-83491	222	YT-8447	218	YT-85120	430; 496	YT-8869	493	YT-99853	486
YT-8273	148; 249; 424	YT-83205	220	YT-83384	221	YT-83492	222	YT-8448	218	YT-85130	430; 496	YT-8870	493		
YT-82742	148; 249	YT-83206	220	YT-83385	221	YT-83493	222	YT-8449	218	YT-85131	430; 496	YT-8876	490		
YT-82743	148; 249	YT-83207	220	YT-83386	221	YT-83494	222	YT-8450	218	YT-85132	429; 495	YT-8885	493		
YT-82744	148; 249	YT-83208	220	YT-83390	221	YT-83495	222	YT-8451	218	YT-85133	429; 495	YT-8886	493		
YT-82851	408	YT-83209	220	YT-83391	221	YT-83496	222	YT-8452	218	YT-85140	431; 497	YT-8889	493		
YT-82853	408	YT-83210	220	YT-83392	221	YT-83497	222	YT-8453	218	YT-85350	428; 486	YT-8890	493		
YT-82855	408	YT-83211	220	YT-83393	221	YT-83498	222	YT-8454	218	YT-85401	427	YT-8891	493		
YT-82857	409	YT-83220	220	YT-83394	221	YT-8350	218	YT-8455	218	YT-85402	427	YT-8892	493		
YT-82858	409	YT-83221	220	YT-83395	221	YT-8351	218	YT-8456	218	YT-85403	427	YT-8894	494		
YT-82859	409	YT-83222	220	YT-83396	221	YT-8352	218	YT-8457	218	YT-85421	427	YT-8940	482		
YT-82861	409	YT-83223	220	YT-83397	221	YT-8353	218	YT-8458	218	YT-85422	427	YT-8941	482		
YT-82862	409	YT-83224	220	YT-83398	221	YT-8354	218	YT-8459	218	YT-85432	426	YT-8950	480		
YT-82863	409	YT-83225	220	YT-83399	221	YT-8355	218	YT-8460	218	YT-85434	426	YT-8955	480		
YT-82900	411; 420	YT-83226	220	YT-83400	221	YT-8356	218	YT-8461	218	YT-85437	426	YT-8956	480		
YT-82930	282; 410	YT-83227	220	YT-83401	221	YT-8357	218	YT-8462	218	YT-85440	426	YT-8957	481		
YT-82931	282; 410	YT-83228	220	YT-83420	222	YT-8358	218	YT-8463	218	YT-86800	494	YT-8958	481		
YT-82932	282; 410	YT-83229	220	YT-83421	222	YT-8360	218	YT-8464	218	YT-86801	494	YT-8959	481		
YT-8300	376	YT-83230	220	YT-83422	222	YT-8361	218	YT-8465	218	YT-86804	494	YT-8960	482		
YT-8301	376	YT-83231	220	YT-83423	222	YT-8362	218	YT-8466	218	YT-86805	494	YT-8962	483		
YT-83016	376	YT-83232	220	YT-83424	222	YT-8363	218	YT-8480	219	YT-86808	494	YT-8963	481		
YT-8302	376	YT-83233	220	YT-83425	222	YT-8364	218	YT-8481	219	YT-86809	494	YT-8964	481		
YT-8303	376	YT-83234	220	YT-83426	222	YT-8365	218	YT-8482	219	YT-8790	488	YT-8965	480		
YT-8304	377	YT-83235	220	YT-83427	222	YT-8366	218	YT-8483	219	YT-8791	488	YT-8966	480		
YT-8305	377	YT-83236	220	YT-83428	222	YT-8367	218	YT-8484	219	YT-8800	487	YT-8967	481		
YT-83051	377	YT-83237	220	YT-83430	222	YT-8368	218	YT-8485	219	YT-8801	487	YT-8968	482		
YT-83052	377	YT-83238	220	YT-83431	222	YT-8370	218	YT-8486	219	YT-8802	487	YT-8970	478		
YT-83060	377	YT-83239	220	YT-83432	222	YT-8371	218	YT-84900	432; 498	YT-8805	487	YT-8971	478		
YT-83061	377	YT-83240	220	YT-83433	222	YT-8372	218	YT-84905	432; 498	YT-8807	487	YT-8972	478		
YT-83062	377	YT-83271	221	YT-83434	222	YT-8373	218	YT-84920	431; 497	YT-8808	487	YT-8973	479		
YT-8310	268; 378	YT-83272	221	YT-83435	222	YT-8374	218	YT-84930	434; 500	YT-8809	487	YT-8974	479		
YT-83101	268; 378	YT-83273	221	YT-83436	222	YT-8375	218	YT-84931	434; 500	YT-8811	487	YT-8975	479		
YT-8311	268; 378	YT-83274	221	YT-83437	222	YT-8376	218	YT-84932	434; 500	YT-8815	488	YT-8976	479		
YT-83151	378	YT-83275	221	YT-83438	222	YT-8377	218	YT-84933	434; 500	YT-8816	488	YT-8977	479		
YT-83152	378	YT-83276	221	YT-83440	222	YT-8378	218	YT-84934	434; 500	YT-8817	488	YT-8978	479		
YT-83153	378	YT-83291	221	YT-83441	222	YT-8400	219	YT-84935	435; 501	YT-8821	491	YT-8979	478		
YT-83160	219	YT-83292	221	YT-83442	222	YT-8401	219	YT-84936	435; 501	YT-8822	491	YT-8984	484		
YT-83161	219	YT-83293	221	YT-83443	222	YT-8402	219	YT-84940	435; 501	YT-8823	491	YT-8985	484		
YT-83162	219	YT-83294	221	YT-83444	222	YT-8403	219	YT-84941	435; 501	YT-8824	491	YT-8986	484		
YT-83163	219	YT-83295	221	YT-83445	222	YT-8404	219	YT-84942	435; 501	YT-8831	489	YT-8987	484		
YT-83164	219	YT-83296	221	YT-83446	222	YT-8405	219	YT-84943	436; 502	YT-8832	489	YT-8991	485		
YT-83165	219	YT-83351	221	YT-83447	222	YT-8406	219	YT-84944	436; 502	YT-8833	489	YT-8993	485		
YT-83166	219	YT-83352	221	YT-83448	222	YT-8407	219	YT-84945	436; 502	YT-8834	489	YT-9920	483		
YT-83167	219	YT-83353	221	YT-83451	222	YT-8408	219	YT-84950	436; 502	YT-8835	489	YT-9940	479		
YT-83168	219	YT-83354	221	YT-83452	222	YT-8409	219	YT-84951	436; 502	YT-8836	489	YT-9941	479		
YT-83169	219	YT-83355	221	YT-83453	222	YT-8410	219	YT-84953	436; 502	YT-8838	489	YT-99801	478		
YT-83180	220	YT-83356	221	YT-83454	222	YT-8411	219	YT-84954	437; 503	YT-8839	490	YT-99802	478		
YT-83181	220	YT-83361	221	YT-83455	222	YT-8412	219	YT-84955	437; 503	YT-8840	490	YT-99803	478		
YT-83182	220	YT-83362	221	YT-83456	222	YT-8413	219	YT-84960	437; 503	YT-8841	490	YT-99804	478		
YT-83183	220	YT-83363	221	YT-83457	222	YT-8414	219	YT-84961	437; 503	YT-8842	490	YT-99810	478		



MANUFACTURER / PRODUCENT

TOYA S.A.
ul. Sołtysowicka 13-15
51-168 Wrocław
☎ (+48 71) 32 46 200
fax: (+48 71) 32 46 370
sales@yato.pl (sale)
export@yato.pl (export)
import@yato.pl (import)

ODDZIAŁ WARSZAWSKI
Teren ProLogis Park Nadarzyn
al. Kasztanowa 160
05-831 Młochów k. Warszawy
☎ (+48 22) 73 82 800
☎ (+48 22) 73 82 828
sales@yato.pl (sale)
export@yato.pl (export)

TOYA ROMANIA S.A.
Sos. Odăi Nr. 109-123
Sector 1, București
☎ 0040 031 710 8692
office@yato.ro

YATO TOOLS (SHANGHAI) Co., Ltd
No. 8 Lane 1300
East KangQiao Road
Shanghai 201315
☎ (+86 21) 209 811 06
fax: (+86 21) 209 811 08
yato@yato-sh.com

YOUR TRUSTED SUPPLIER: / TWÓJ ZAUFANY DOSTAWCA:



www.yato.com

COPYRIGHT © TOYA S.A. 2017

**GET ACQUAINTED WITH OUR WIDE OFFER:
ZOBACZ NASZĄ BOGATĄ OFERTĘ:**

